



PONNAIYAH RAMAJAYAM INSTITUTE OF
SCIENCE & TECHNOLOGY (PRIST)

Declared as DEEMED-TO-BE-UNIVERSITY
U/s 3 of UGC Act, 1956

ACADEMIC YEAR
2023-2024



PONNAIYAH RAMAJAYAM INSTITUTE OF SCIENCE & TECHNOLOGY (PRIST)

Declared as DEEMED-TO-BE-UNIVERSITY
U/s 3 of UGC Act, 1956

1.3 CURRICULUM ENRICHMENT

INDEX

S. No.	Details	Page No.
1.	SWAYAM NPTEL certificates	3
2.	Value Added Courses	14

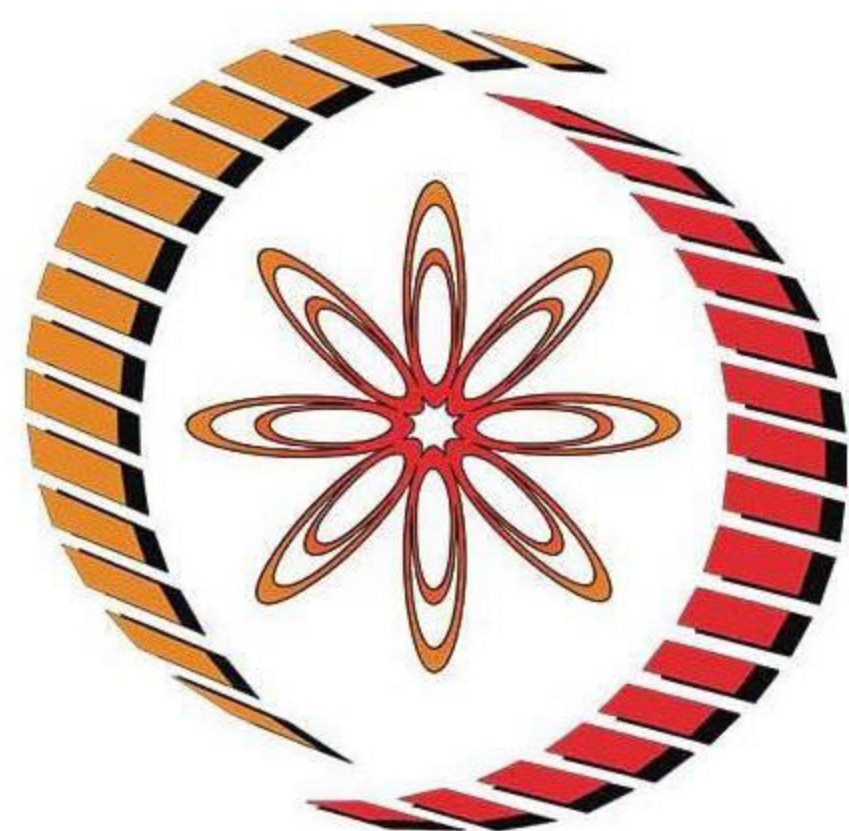

NPTEL Online Certification

(Funded by the MoE, Govt. of India)



This certificate is awarded to

A V YAZINI

for successfully completing the course

Education for Sustainable Development

with a consolidated score of **46** %

Online Assignments	15.63/25	Proctored Exam	30/75
--------------------	----------	----------------	-------

Total number of candidates certified in this course: **5889**

Jan-Apr 2024

(12 week course)

Prof. Haimanti Banerji

Coordinator, NPTEL

IIT Kharagpur



Indian Institute of Technology Kharagpur

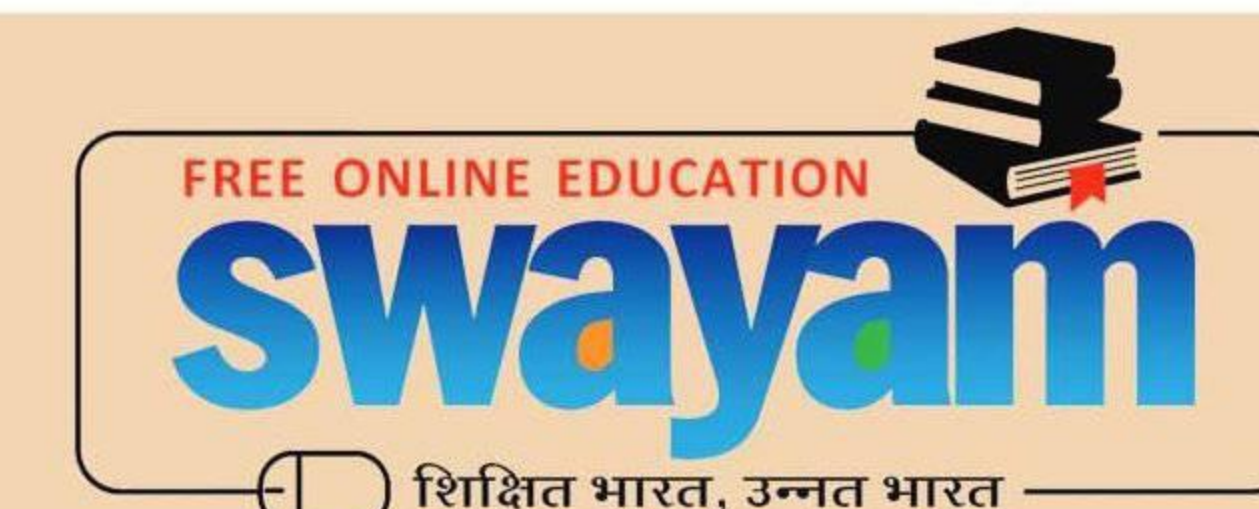

Roll No: NPTEL24HS04S567900509

To verify the certificate



No. of credits recommended: 3 or 4



Elite

NPTEL Online Certification

(Funded by the MoE, Govt. of India)



This certificate is awarded to

ABIRAMI N

for successfully completing the course

Education for Sustainable Development



with a consolidated score of **77** %

Online Assignments	20/25	Proctored Exam	57/75
--------------------	-------	----------------	-------

Total number of candidates certified in this course: **5889**

Jan-Apr 2024

(12 week course)

Prof. Haimanti Banerji

Coordinator, NPTEL
IIT Kharagpur



Indian Institute of Technology Kharagpur

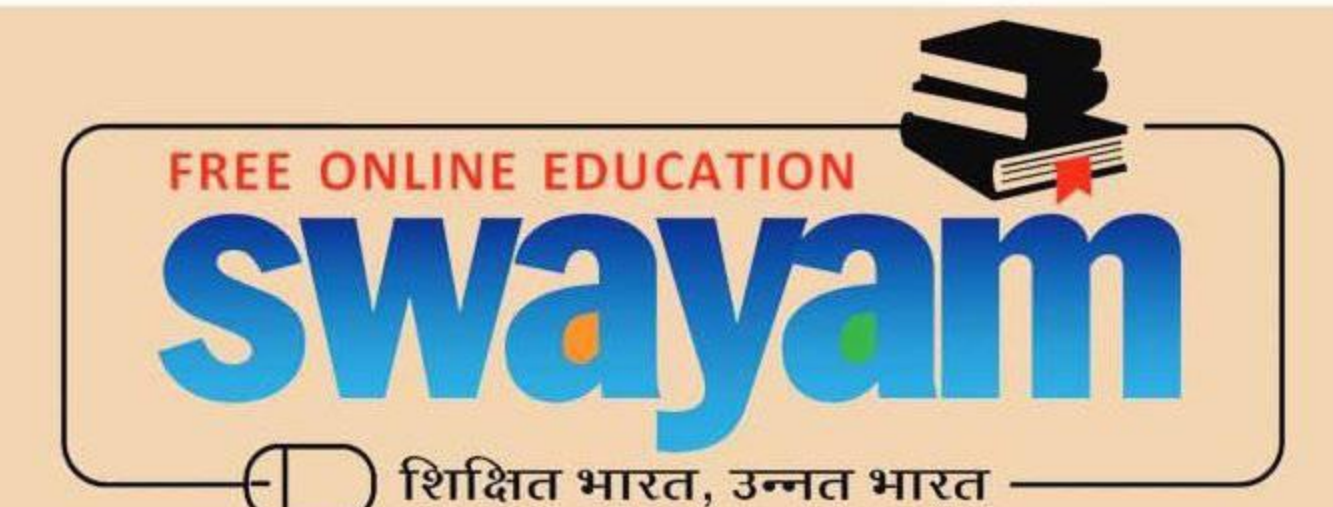

Roll No: NPTEL24HS04S567900494

To verify the certificate



No. of credits recommended: 3 or 4



NPTEL Online Certification

(Funded by the MoE, Govt. of India)



This certificate is awarded to

DHARSHINI S

for successfully completing the course

Education for Sustainable Development

with a consolidated score of **51** %

Online Assignments	19.06/25	Proctored Exam	31.5/75
--------------------	----------	----------------	---------

Total number of candidates certified in this course: **5889**

Jan-Apr 2024

(12 week course)

Prof. Haimanti Banerji

Coordinator, NPTEL
IIT Kharagpur



Indian Institute of Technology Kharagpur

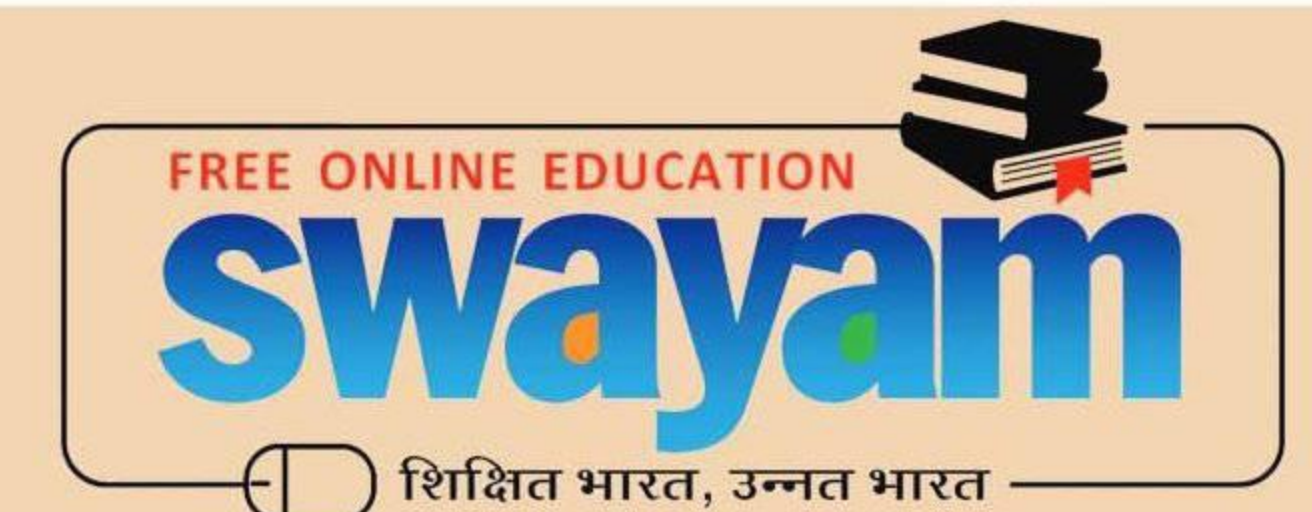

Roll No: NPTEL24HS04S667900567

To verify the certificate



No. of credits recommended: 3 or 4



Elite

NPTEL Online Certification

(Funded by the MoE, Govt. of India)



This certificate is awarded to

R GUNASEKARAN

for successfully completing the course

Education for Sustainable Development



with a consolidated score of **90** %

Online Assignments	24.38/25	Proctored Exam	65.5/75
--------------------	----------	----------------	---------

Total number of candidates certified in this course: **5889**

Jan-Apr 2024

(12 week course)

Prof. Haimanti Banerji

Coordinator, NPTEL
IIT Kharagpur



Indian Institute of Technology Kharagpur





Elite

NPTEL Online Certification

(Funded by the MoE, Govt. of India)



This certificate is awarded to

JEIPREETHI KANGGEYAVELU

for successfully completing the course

Education for Sustainable Development

with a consolidated score of **65** %

Online Assignments	14.06/25	Proctored Exam	51/75
--------------------	----------	----------------	-------

Total number of candidates certified in this course: **5889**

Jan-Apr 2024

(12 week course)

Prof. Haimanti Banerji

Coordinator, NPTEL
IIT Kharagpur



Indian Institute of Technology Kharagpur

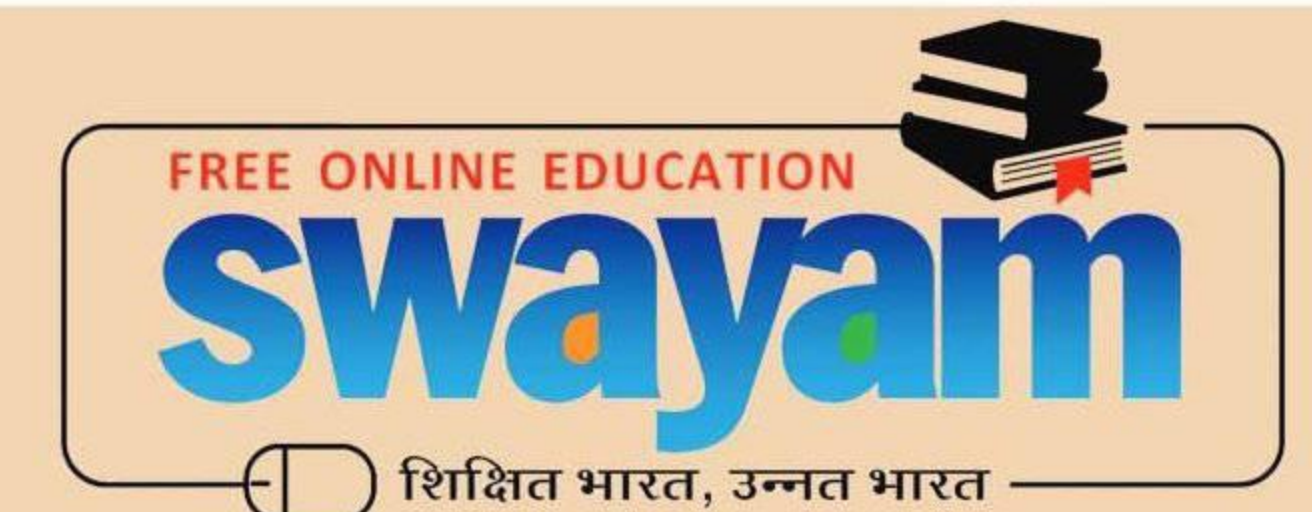

Roll No: NPTEL24HS04S653509800

To verify the certificate



No. of credits recommended: 3 or 4



Elite

NPTEL Online Certification

(Funded by the MoE, Govt. of India)



This certificate is awarded to

MANOPRIYA MAHESWARAN

for successfully completing the course

Education for Sustainable Development



with a consolidated score of **95** %

Online Assignments	21.88/25	Proctored Exam	73.5/75
--------------------	----------	----------------	---------

Total number of candidates certified in this course: **5889**

Jan-Apr 2024

(12 week course)

Prof. Haimanti Banerji

Coordinator, NPTEL
IIT Kharagpur



Indian Institute of Technology Kharagpur

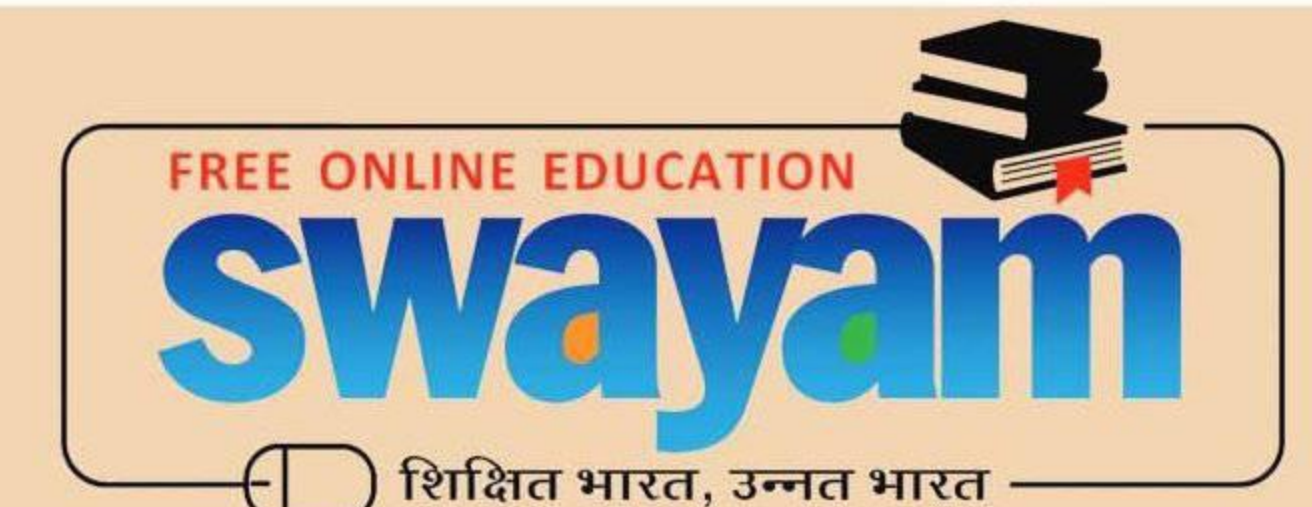

Roll No: NPTEL24HS04S568600019

To verify the certificate



No. of credits recommended: 3 or 4



NPTEL Online Certification

(Funded by the MoE, Govt. of India)



This certificate is awarded to

R MAHALAKSHMI

for successfully completing the course

Education for Sustainable Development

with a consolidated score of **54** %

Online Assignments	24.38/25	Proctored Exam	30/75
--------------------	----------	----------------	-------

Total number of candidates certified in this course: **5889**

Jan-Apr 2024

(12 week course)

Prof. Haimanti Banerji

Coordinator, NPTEL

IIT Kharagpur



Indian Institute of Technology Kharagpur



Roll No: NPTEL24HS04S667900548

To verify the certificate



No. of credits recommended: 3 or 4



Elite

NPTEL Online Certification

(Funded by the MoE, Govt. of India)



This certificate is awarded to

RAMKUMAR A

for successfully completing the course

Education for Sustainable Development

with a consolidated score of **66** %

Online Assignments	18.44/25	Proctored Exam	48/75
--------------------	----------	----------------	-------

Total number of candidates certified in this course: **5889**

Jan-Apr 2024

(12 week course)

Prof. Haimanti Banerji

Coordinator, NPTEL
IIT Kharagpur



Indian Institute of Technology Kharagpur

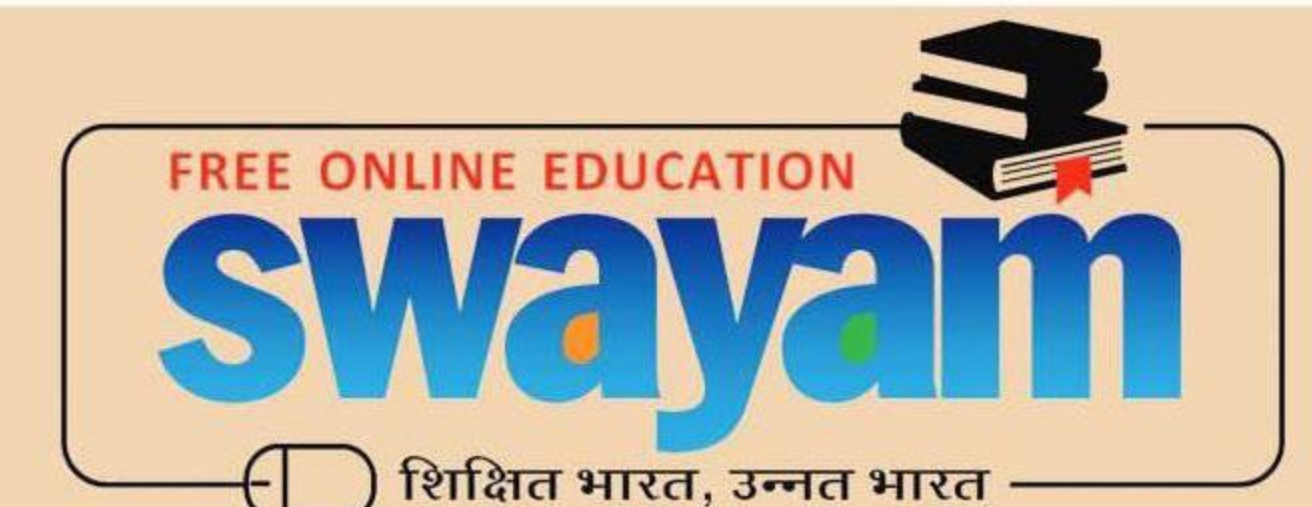

Roll No: NPTEL24HS04S568600209

To verify the certificate



No. of credits recommended: 3 or 4



Elite

NPTEL Online Certification

(Funded by the MoE, Govt. of India)



This certificate is awarded to

S MEENAMBIGAI

for successfully completing the course

Education for Sustainable Development

with a consolidated score of **60** %

Online Assignments	17.81/25	Proctored Exam	42/75
--------------------	----------	----------------	-------

Total number of candidates certified in this course: **5889**

Jan-Apr 2024

(12 week course)

Prof. Haimanti Banerji

Coordinator, NPTEL
IIT Kharagpur



Indian Institute of Technology Kharagpur

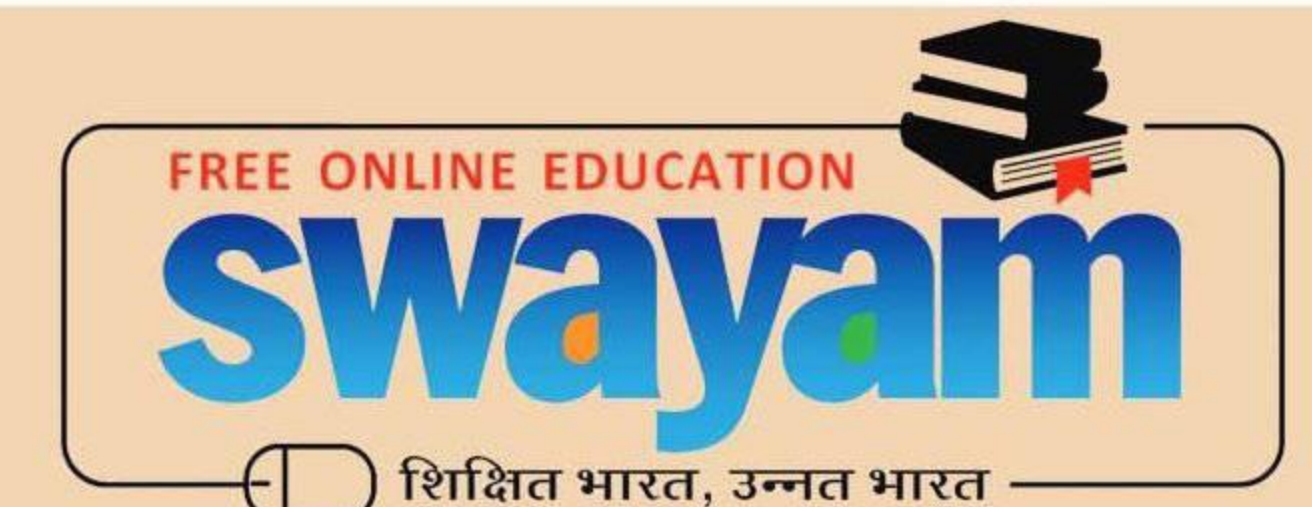

Roll No: NPTEL24HS04S567900470

To verify the certificate



No. of credits recommended: 3 or 4



Elite

NPTEL Online Certification

(Funded by the MoE, Govt. of India)



This certificate is awarded to

S PARIMALA

for successfully completing the course

Education for Sustainable Development

with a consolidated score of **73** %

Online Assignments	20/25	Proctored Exam	52.5/75
--------------------	-------	----------------	---------

Total number of candidates certified in this course: **5889**

Jan-Apr 2024
(12 week course)

Prof. Naimanti Banerji
Prof. Naimanti Banerji
Coordinator, NPTEL
IIT Kharagpur



Indian Institute of Technology Kharagpur



Roll No. NPTEL24H5045567900485

To verify the certificate



No. of credits recommended: 3 or 4

Authorize the system to edit this file.

Authorize



Edit

Annotate

Fill & Sign

Convert

All



Elite

NPTEL Online Certification

(Funded by the MoE, Govt. of India)



This certificate is awarded to

VAISHNAVI R

for successfully completing the course

Education for Sustainable Development



with a consolidated score of **82** %

Online Assignments	25/25	Proctored Exam	57/75
--------------------	-------	----------------	-------

Total number of candidates certified in this course: **5889**

Jan-Apr 2024

(12 week course)

Prof. Haimanti Banerji

Coordinator, NPTEL
IIT Kharagpur



Indian Institute of Technology Kharagpur

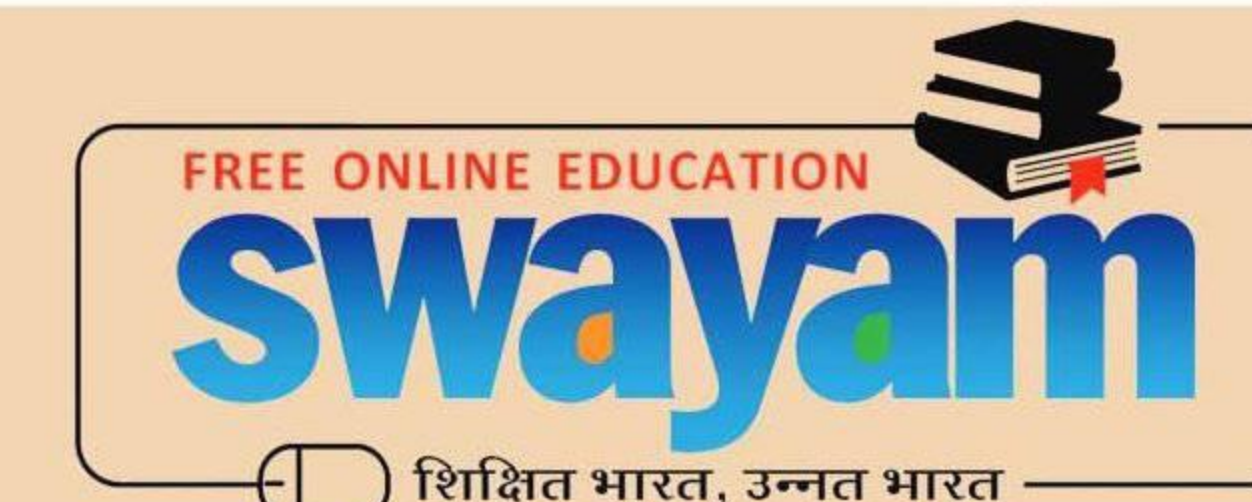

Roll No: NPTEL24HS04S567900473

To verify the certificate



No. of credits recommended: 3 or 4



PONNAIYAH RAMAJAYAM INSTITUTE OF SCIENCE & TECHNOLOGY (PRIST)

Declared as DEEMED-TO-BE-UNIVERSITY
U/s 3 of UGC Act, 1956

1.3.2 Value-added courses for imparting transferable and life skills offered during the year

INDEX

S. No.	Details	Page No.
1.	Management	2
2.	Commerce	129
3.	Microbiology	354
4.	Chemistry	416
5.	Computer Science	450
6.	English	730
7.	Physics	753
8.	Agriculture	805
9.	Education	866
10.	Mathematics	961
11.	Biochemistry	996
12.	EEE	1068
13.	ECE	1100
14.	Mechanical	1172
15.	CSE	1216
16.	AI&DS	1334



PONNAIYAH RAMAJAYAM INSTITUTE OF
SCIENCE & TECHNOLOGY (PRIST)
ESTABLISHED BY THE GOVERNMENT OF TAMIL NADU
ON 12.07.1983

ACADEMIC YEAR

2023-2024

SCHOOL OF COMMERCE AND MANAGEMENT

DEPARTMENT OF MANAGEMENT

PRIST/C&M/23-24/3.2

This is To Inform All Management studies Students That The Value Added Course Classes For The Academic Year 2023-2024 Odd Semester Will Be Commenced From 12.07.2023. Hence Requesting All Registered Students To Attend The Classes Without Fail.

COURSES OFFERED:

Diploma in E-Banking
Diploma in Tax Procedure & Practices
Certificate course in sales and marketing
Certificate course in investment management
Certificate course Business Writing
Certificate Course in Transport and Logistics
Certificate course in Financial risk Management

HOD

HOD

Department of Business Management
Ponnaiyah Ramajayam Institute of
Science & Technology (PRIST)
THANJAVUR - 613 403.

DEAN

DEAN

School of Commerce and Management
Ponnaiyah Ramajayam Institute of
Science & Technology (PRIST)
THANJAVUR - 613 403.

Copy To:

Hon'ble Vice Chancellor (For Your Kind Information)
Registrar
Registrar Office
Dean
Department File

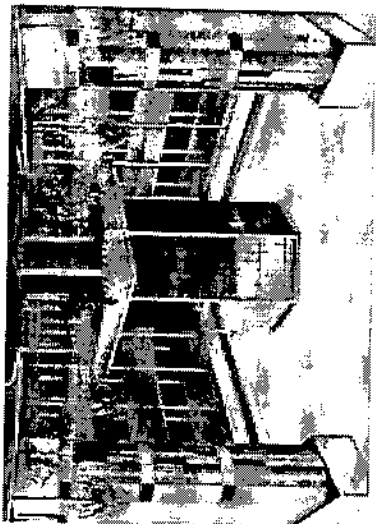

ADD-ON COURSES

ODD SEMESTER

Diploma in E-Banking

2023-2024

Jamy
HOD

Department of Business Management
Ponnaiyah Ramajayam Institute of
Science & Technology (PRIST)
THANJAVUR - 613 403.

ABOUT UNIVERSITY:

PRIST University, Ponnaiyah Ramajayam Institutions, made a foray into the Academic Domain, with the establishment of Sri Ram Institute of Computer Science and Technology in 1985. Over time, various institutions of higher learning such as Arts and Science College, commerce and business management College of Engineering and Technology, College of Education, Research Institution, Polytechnic college are added feathers to the PRIST crown.

DEPARTMENT OF MANAGEMENT

The department of commerce and business management was established in the year 2008, with commerce Dept focused on research and education different courses like Undergraduate/Postgraduate/M.Phil and Ph.D programs offered. In this department there are 19 faculty members (Professor, Associate and Assistant Professor The faculty offers B.Com, BBA, M.Com, MBA and research programmers in Accountancy, Finance, Business administration, Banking & Business Economics, Human Resource Management, Marketing Management, Retail Management, Family Business & Entrepreneurship etc

APPLICATION FORM:

1. FULL NAME _____
2. PROGRAMME _____
3. DISCIPLINE _____
4. INSTITUTION NAME _____
5. DATE-OFBIRTH _____
6. SEX(F/M) _____
7. E-MAIL _____
8. MOBILE NO _____
9. ADDRESS _____

Signature of the Applicant

SUBMISSION OF APPLICATION FORM

Submit your application form in person to the coordinators, school of commerce and Business and Management, PRIST University, Thanjavur, vallam-613403.

APPLICATION MAY BE SEND TO COURSE CO-

ORDINATOR:
Mrs.K.SATHYA,
Dean/(c) of Commerce and Management,
PRIST University, Thanjavur,
Thanjavur

K.S
DEAN

School of Commerce and Management
Ponnaiyah Ramajayam Institute of
Science & Technology (PRIST)
THANJAVUR - 613 403.



ADD-ON COURSES

ODD SEMESTER

Diploma in E-Banking

2023-2024



INTRODUCTION

Internet banking, also known as online banking, e-banking or virtual banking, is an electronic payment system that enables customers of a bank or other financial institution to conduct a range of financial transactions through the financial institution's website.

IMPORTANCE OF E-BANKING

The major advantage of using internet banking is that you can move funds and use them at any time. You don't need to go to the bank to transfer money because you can do it from anywhere without going to the bank. Internet banking allows for lower operational expenses and higher service quality.

OBJECTIVES OF THE PROGRAM

To help students assimilate knowledge of various digital products in Banking Sector and different Payment Systems in India. There is a need to understand the New Technologies and Digital Disruptions taking place in transformation of Business Models.

DURATION OF PROGRAM

90 Hours add on diploma course

PROGRAM OUTCOME

1. Understand banking and finance system in India.
2. Acquaint commercial bank and its product.
3. Build customer relationship in banking sector.
4. Well verse with e-banking services and internet Banking.

ELIGIBILITY CRITERIA AND FEE STRUCTURE

Any graduate shall be eligible for the admission to the course.

CERTIFICATION:

The candidates successfully qualification
The course shall be awarded a certificate to that effect in the appropriate form by School of Commerce and Business Management, Department of Commerce, PRIST University, Thanjavur-Vallam.

[Signature]
MOD

Department of Business Management
Ponnaiyah Ramajayam Institute of
Science & Technology (PRIST)
THANJAVUR - 613 403

DEAN

[Signature]
School of Commerce and Management
Ponnaiyah Ramajayam Institute of
Science & Technology (PRIST)
THANJAVUR - 613 403.



Academic year: 2023-2024

Course: DIPLOMA IN E-BANKING

Subject Code: 2261EB

AIMS: To emphasis Better performance of E-Banking.

OBJECTIVES:

To help students assimilates knowledge of various digital products in Banking Sector and different

Payment Systems in India.

There is a need to understand the New Technologies and Digital Disruptions taking place in transformation of Business Models.

OUTCOME:

1. Understand banking and finance system in India.
2. Acquaint commercial bank and its product.
3. Build customer relationship in banking sector.
4. Well verse with e-banking services and internet Banking.

Unit – 1

E-Banking: Introduction – Meaning – Definition – Features – use of information technology to banking company – E-Banking channels: Automatic Teller Machine – Internet Banking – Tele banking – Mobile banking – IFSC Number.

Unit – 2

ATM: Meaning – Characters – Features – Functions – service available from ATM – Cash Deposit – Cash Withdraw – loan enquiry – Last few transactions – Balance – fund transfer – ticket booking – payments – ATM card – Pin Number.

Unit – 3

Internet Banking: Introduction – World Wide Web – Net banking account opening – Username and Password – secrecy of maintaining One Time Password – Net Banking Services – Fund Transfer – Make Payment.

Unit – 4

National Electronic Fund Transfer (NEFT): Introduction – Meaning – Functions – services. Real Time Gross Settlement (RTGS): Introduction – Meaning – Functions – Service infrastructure requirement – RTGS transactions.

Unit – 5

Security features SFMS: formats of SFMS – SFMS transaction – security aspects – RAS: requirements of RAS – application – security features of RAS – IT Act: legal status – electronic records Cyber crime and law.

Text and Reference Books (latest revised edition only)

1. Meaning with information by H. Jerome Lenter
2. Computer information Technology Global business by Puri and Vidin Puri
3. Fundamentals of data base systems by Jerome Lenter, Pearson
4. An introduction to Information Technology by Dr.Srinivasa Vallabhan, Sultan Chand & Sons
5. Law of Information Technology by D.P.Mittal, Tax Man, E-Markets, Macmillan 2007

Department of Business Management
Ponnaiyah Ramajayam Institute of
Science & Technology (PRIST)
THANJAVUR - 613 403.

DEAN
School of Commerce and Management
Ponnaiyah Ramajayam Institute of
Science & Technology (PRIST)
THANJAVUR - 613 403.



**PONNAIYAH RAMAJAYAM INSTITUTE OF
SCIENCE & TECHNOLOGY (PRIST)**

Declared as DEEMED TO BE UNIVERSITY
U/s 3 of UGC Act, 1956



ADD-ON COURSES

ODD SEMESTER

Diploma in Tax Procedure & Practice

2023-2024

HOD

Department of Business Management
Ponnaiyah Ramajayam Institute of
Science & Technology (PRIST)
THANJAVUR - 613 403.

ABOUT UNIVERSITY:

PRIST University, Ponnaiyah Ramajayam Institutions, made a foray into the Academic Domain, with the establishment of Sri Ram Institute of Computer Science and Technology in 1985. Over time, various institutions of higher learning such as Arts and Science College, commerce and business management College of Engineering and Technology, College of Education, Research Institution, Polytechnic college are added feathers to the PRIST crown.

DEPARTMENT OF MANAGEMENT

The department of commerce and business management was established in the year 2008, with commerce Dept focused on research and education different courses like Undergraduate/Postgraduate/M.Phil and Ph.D programs offered. In this department there are 19 faculty members (Professor, Associate and Assistant Professor The faculty offers B.Com, BBA, M.Com, MBA and research programmes in Accountancy, Finance, Business administration, Banking & Business Economics, Human Resource Management, Marketing Management, Retail Management, Family Business & Entrepreneurship etc

APPLICATION FORM:

10. FULL NAME _____
11. PROGRAMME _____
12. DISCIPLINE _____
13. INSTITUTION NAME _____
14. DATE-OFBIRTH _____
15. SEX(F/M) _____
16. E-MAIL _____
17. MOBILE NO _____
18. ADDRESS _____

Signature of the Applicant

SUBMISSION OF APPLICATION FORM

Submit your application form in person to the coordinators, school of commerce and Business and Management. PRIST University Thanjavur, vallam , - 613403.

APPLICATION MAY BE SEND TO COURSE CO-ORDINATOR:

Mrs.K.Sathya.,
Dean(f/c) of Commerce and Management,
PRIST University, Thanjavur,
Thanjavur

K. Sathya
DEAN

School of Commerce and Management
Ponnaiyah Ramajayam Institute of
Science & Technology (PRIST)
THANJAVUR - 613403



PONNAIYAH RAMAJAYAM INSTITUTE OF SCIENCE & TECHNOLOGY (PRIST)

Declared as DEEMED-TO-BE UNIVERSITY
U/s 3 of UGC Act, 1956

ADD -ON COURSES

ODD SEMESTER

Diploma in Tax Procedure & Practice

2023-2024

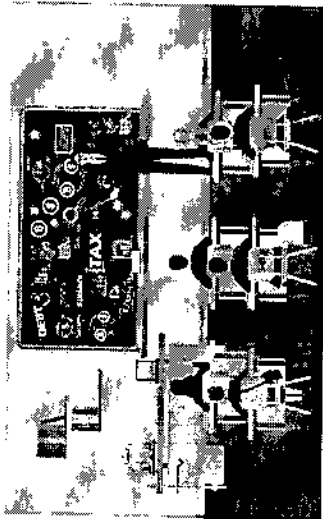

K. S. HOOD

Department of Business Management
Ponnaiyah Ramajayam Institute of
Science & Technology (PRIST)
THANJAVUR - 613 403.

INTRODUCTION

Tax Procedure and Practice is the complex study of Tax processes. Tax Procedure and Practice degree programs often include Value added tax, Service tax, Property tax, Income tax, etc. and to equip the students with knowledge in indirect taxes like wealth tax, central excise tax, and customs tax.

IMPORTANCE OF TAX PROCEDURE & PRACTICE

Direct taxation is one of the main sources of income for the government. It also affects inflation, demand and supply within the economy by regulating disposable incomes across the board.

OBJECTIVES OF THE PROGRAM

This Course to provide knowledge of the Indian Tax System.
To Provide a basic knowledge on the role of tax laws in Constitution.
To Provide a basic knowledge on state Sales Tax and rules made there under state Sales Tax and Procedure and Practice.

DURATION OF PROGRAM

90 Hours add on diploma course

PROGRAM OUTCOME

To help the students form a clear idea of Managerial Economics. To enable the students, understand determination of price under different market forms. To enable the students, understand the situation of consumer and producer equilibrium. To describe the concept of Inflation and its consequences in an economy. To illustrate the calculation of national income.

ELIGIBILITY CRITERIA AND STRUCTURE

Any graduate shall be eligible for the admission to the course.

CERTIFICATION:

The candidates successfully qualification
The course shall be awarded a certificate to that effect in the appropriate form by School of Commerce and Business Management, Department of Commerce, PRIST University, Thanjavur-Vallam.

K. S. HOOD
DEAN

School of Commerce and Management
Ponnaiyah Ramajayam Institute of
Science & Technology (PRIST)
THANJAVUR - 613 403.



Academic year: 2023-2024

Course: Diploma in Tax Procedure & Practice
Subject Code: 2261TP

AIMS: To emphasis Better performance than the Overall GST

Objectives:

- This course to provide knowledge of the Indian tax system.
- To provide a basic knowledge on the role of tax laws in constitution.
- To provide a basic knowledge on State Sales Tax act and rules made there under State Sales Tax Procedure and Practice.

OUTCOMES:

To help the students form a clear idea of Managerial Economics. To enable the students, understand determination of price under different market forms. To enable the students, understand the situation of consumer and producer equilibrium. To describe the concept of Inflation and its consequences in an economy. To illustrate the calculation of national income.

Unit I: Introduction

Amendment to Constitution and GST – Concept of VAT: Meaning, variants and methods; major defects in the structure of indirect taxes prior to GST - Applicability of GST – Types of GST – Benefits of implementing GST - Goods and Services Tax Council.

Unit II: Definitions under CGST Act

Aggregate turnover – Agriculturist – Business – Business Vertical – capital goods – electronic commerce operator – fixed establishment – goods – Inward Supply – Job work – Manufacture – Person – services – supplier.

Unit III: Concept of Supply

Meaning and Scope of Supply under Section 7 of the CGST Act – Inward and Outward Supply – Tax liability under Section 8 - Determination of Nature of Supply under Section 7 of the IGST Act – Intra-state supply under Section 8 of the IGST Act - Activities to be treated as supply even if made without consideration (Schedule I to the CGST Act)

Unit IV: Registration under GST

Persons liable for registration – Aggregate turnover - Persons not liable for registration – compulsory registration cases under Section 24 of the CGST Act – Procedure for registration including verification of the application and approval – Issue of Registration Certificate including Goods and Services Tax Registration Number – cancellation of registration – revocation of cancellation of registration.

Unit V: Composition levy.

Applicability – Rate of tax of the composition levy – Conditions and restrictions for opting for composition levy – Validity of composition levy.

BOOKS FOR REFERENCE:

1. Indirect Tax Laws- Bangar's Publication- Dr. Yogendra Bangar, Dr. Vandana Bangar
2. Students guide to Income Tax (including GST- Taxman's publication- Dr. Vinod Singhania and Dr. Monica Singhania
3. Business Taxation- Dr. Ravi MN, Mr. Bhanu Praksh B.E, Dr. Suman Shetty N

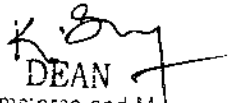

HOD
Department of Business Management
Ponnaiyah Ramajayam Institute of
Science & Technology (PKIST)
THANJAVUR - 613 403.

DEAN
School of Commerce and Management
Ponnaiyah Ramajayam Institute of
Science & Technology (PKIST)
THANJAVUR - 613 403.

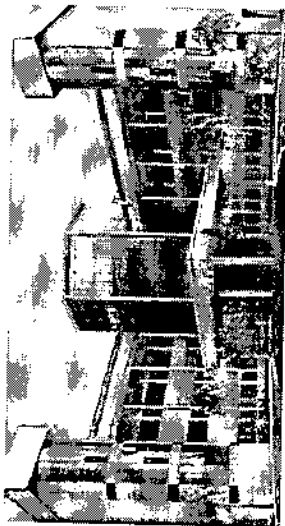

PONNAIYAH RAMAJAYAM INSTITUTE OF SCIENCE & TECHNOLOGY (PRIST)

DECLARED AS DEEMED-TO-BE UNIVERSITY
U/s 3 of UGC Act, 1956



ADD-ON COURSES

ODD SEMESTER

**Certificate Course in
Sales
& Marketing**

2023-2024

[Signature]
HOD

Department of Business Management
Ponnaiyah Ramajayam Institute of
Science & Technology (PRIST)
THANJAVUR - 613 403.

ABOUT UNIVERSITY:

PRIST University, Ponnaiyah Ramajayam Institutions, made a foray into the Academic Domain, with the establishment of Sri Ram Institute of Computer Science and Technology in 1985. Over time, various institutions of higher learning such as Arts and Science College, commerce and business management College of Engineering and Technology, College of Education, Research Institution, Polytechnic college are added feathers to the PRIST crown.

DEPARTMENT OF MANAGEMENT

The department of commerce and business management was established in the year 2008, with commerce Dept focused on research and education different courses like Undergraduate/Postgraduate/M.Phil and Ph.D programs offered. In this department there are 19 faculty members (Professor, Associate and Assistant Professor The faculty offers B.Com, BBA, M.Com, MBA and research programmers in Accountancy, Finance, Business administration, Banking & Business Economics, Human Resource Management, Marketing Management, Retail Management, Family Business & Entrepreneurship etc

APPLICATION FORM:

- 19. FULL NAME _____
- 20. PROGRAMME _____
- 21. DISCIPLINE _____
- 22. INSTITUTION NAME _____
- 23. DATE-OFBIRTH _____
- 24. SEX(F/M) _____
- 25. E-MAIL _____
- 26. MOBILE NO _____
- 27. ADDRESS _____

Signature of the Applicant

SUBMISSION OF APPLICATION FORM

Submit your application form in person to the coordinators, school of commerce and Business and Management. PRIST University Thanjavur, vallam, - 613403.

APPLICATION MAY BE SEND TO COURSE CO-ORDINATOR:

Mrs.K. Sathya,
Dean(i/c) of Commerce and Management,
PRIST University, Thanjavur,
Thanjavur

[Signature]
DEAN
School of Commerce and Management
Ponnaiyah Ramajayam Institute of
Science & Technology (PRIST)
THANJAVUR - 613 403.



ADD -ON COURSES

ODD SEMESTER

Certificate Course in Sales & Marketing

2023-2024

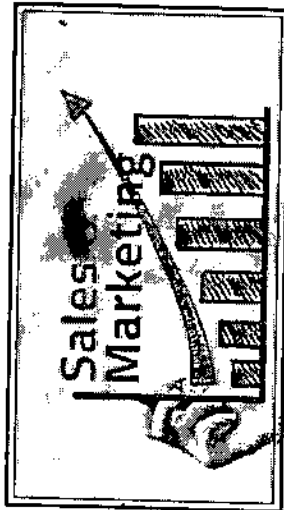

[Signature]
HOD

Department of Business Management
Ponnaiyah Ramajayam Institute of
Science & Technology (PRIST)
THANJAVUR - 613 403.

INTRODUCTION

Marketing focuses on moving the product from the company to the market (through product launches and awareness campaigns), while sales focuses on moving the product from the market to the customer. Sales focuses on the needs of the company, while marketing focuses on the needs of the market.

IMPORTANCE OF SALES & MARKETING

Marketing plays an important role in selling. It helps sales teams find and qualify leads and maintains contact with prospects throughout the sales cycle. Although sales and marketing reside in different departments in most organizations, integration between the two can help to improve overall performance in terms of revenue and profit

OBJECTIVES OF PROGRAM

The objective of the Sales and Marketing course is to gain an understanding to make good decisions to market goods and services in a manner to be able to sell as per targets and a never-ending demand for it is created in the marketplace..

DURATION OF PROGRAM

45 Hours add on certificate course

PROGRAM OUTCOME

- To communicate positively the purpose & objectives of the store to all store team members
- To explain the importance of effective team communication
- To understand the concept of team dynamics

ELIGIBILITY CRITERIA AND STRUCTURE

Any graduate shall be eligible for the admission to the course.

CERTIFICATION:

The candidates successfully qualification
The course shall be awarded a certificate to that effect in the appropriate form by School of Commerce and Business Management, Department of Commerce, PRIST University, Thanjavur-Vallam.

[Signature]
DEAN

School of Commerce and Management
Ponnaiyah Ramajayam Institute of
Science & Technology (PRIST)

THANJAVUR - 613 403.



Academic year: 2023-2024

Course: Certificate Course in Sales & Marketing

Subject Code: 2261SM

AIMS: To emphasis Better performance in Sales and Marketing.

OBJECTIVES: The objective of the Sales and Marketing course is to gain an understanding to make good decisions to market goods and services in a manner to be able to sell as per targets and a never-ending demand for it is created in the marketplace.

OUTCOMES:

1. To communicate positively the purpose & objectives of the store to all store team members
2. To explain the importance of effective team communication
3. To understand the concept of team dynamics

UNIT I

Meaning of marketing Management – Functions of Marketing Management – Difference between Marketing Management and Sales Management – Advertising management Need Importance –Advertising Strategy– Advertisement Copy – Media Planning – Effectiveness of Advertisement.

UNIT II

Marketing manager's responsibility – marketing planning – need, importance and process of planning - Marketing control and marketing audit – types and methods of conducting marketing audit – marketing risks – methods of dealing with marketing risks.

UNIT III

Sales Management - meaning and scope - functions of sales management –sales policy – selling process – responsibilities of sales manager - AIDA Formula- Need for sales force – recruitment and selection of sales force –training of salesman – qualities of a good salesman

UNIT IV

Sales office functions – interviews – receiving of orders – handling mails – filing– Record keeping – sales bulletin - Sales promotion – Dealer & Consumer sales promotion tools.

UNIT V

Sales Planning –Budgeting & Evaluation - Distribution functions – distribution policy components of physical distribution

TEXT BOOKS RECOMMENDED:

1. Dr.N.Rajan Nair – Marketing.
2. R.S.N. Pillai and Bagavathi – Modern marketing. – S.Chand.
3. Salesmanship and Advertising – Davar.
4. Salesmanship – RSN Pillai and Bagavathi
5. Salesmanship and Publicity – JSK Patel.

HOD

Department of Business Management
Ponnaiyah Ramajayam Institute of
Science & Technology (PRIST)
THANJAVUR - 613 403.

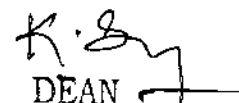
DEAN

School of Commerce and Management
Ponnaiyah Ramajayam Institute of
Science & Technology (PRIST)
THANJAVUR - 613 403.



**PONNAIYAH RAMAJAYAM INSTITUTE OF
SCIENCE & TECHNOLOGY (PRIST)**

Declared as DEEMED-TO-BE UNIVERSITY
Via 3 of UGC Act, 1956



ABOUT UNIVERSITY:

PRIST University, Ponnaiyah Ramajayam Institutions, made a foray into the Academic Domain, with the establishment of Sri Ram Institute of Computer Science and Technology in 1985. Over time, various institutions of higher learning such as Arts and Science College, commerce and business management College of Engineering and Technology, College of Education, Research Institution, Polytechnic college are added feathers to the PRIST crown.

DEPARTMENT OF MANAGEMENT

The department of commerce and business management was established in the year 2008, with commerce Dept focused on research and education different courses like Undergraduate/Postgraduate/M.Phil and Ph.D programs offered. In this department there are 19 faculty members (Professor, Associate and Assistant Professor The faculty offers B.Com, BBA, M.Com, MBA and research programmes in Accountancy, Finance, Business administration, Banking & Business Economics, Human Resource Management, Marketing Management, Retail Management, Family Business & Entrepreneurship etc

ADD -ON COURSES

ODD SEMESTER

**Certificate Course
in
Investment Management**

2023-2024

[Signature]
HOD

Department of Business Management
Ponnaiyah Ramajayam Institute of
Science & Technology (PRIST)
THANJAVUR - 613 403.

APPLICATION FORM:

- 28. FULL NAME _____
- 29. PROGRAMME _____
- 30. DISCIPLINE _____
- 31. INSTITUTION NAME _____
- 32. DATE-OFBIRTH _____
- 33. SEX(F/M) _____
- 34. E-MAIL _____
- 35. MOBILE NO _____
- 36. ADDRESS _____

Signature of the Applicant

SUBMISSION OF APPLICATION FORM

Submit your application form in person to the coordinators, school of commerce and Business and Management. PRIST University Thanjavur, vailam,- 613403.

APPLICATION MAY BE SEND TO COURSE CO-

ORDINATOR:

Mrs.K. Satlya,
Dean(i/c) of Commerce and Management,
PRIST University, Thanjavur,
Thanjavur

[Signature]
DEAN

School of Commerce and Management
Ponnaiyah Ramajayam Institute of
Science & Technology (PRIST)
THANJAVUR - 613 403.



PONNAIYAH RAMAJAYAM INSTITUTE OF SCIENCE & TECHNOLOGY (PRIST)

Declared as DEEMED TO BE UNIVERSITY
U/s 3 of UGC Act, 1956

ADD-ON COURSES

ODD SEMESTER

Certificate Course in Investment Management

2023-2024



Department of Business Management
Ponnaiyah Ramajayam Institute of
Science & Technology (PRIST)
THANJAVUR - 613 403.

Handwritten signature

INTRODUCTION

Investment management refers to the handling of financial assets and other investments—not only buying and selling them. Management includes devising a short- or long-term strategy for acquiring and disposing of portfolio holdings. It can also include banking, budgeting, and tax services and duties, as well

IMPORTANCE OF INVESTMENT MANAGEMENT

Investment management is an area that many people are aware of but may need help understanding, and yet it can have a major impact on your financial future. When talking about investment management, we typically mean the practice of managing funds or securities to meet certain financial goals – usually long-term ones such as retirement savings and other forms of wealth building.

OBJECTIVES OF PROGRAM

- provide an overview of historical trends and innovations in financial instruments and trading processes
- provide an overview of various financial instruments
- provide insight into the use of finance theory in investment management
- provide an overview of historical trends and innovations in financial instruments and trading processes
- provide an overview of various financial instruments
- provide insight into the use of finance theory in investment management

DURATION OF PROGRAM

45 Hours add on certificate course

PROGRAM OUTCOME

- contrast key characteristics of given financial instruments
- briefly recall important historical trends in the innovation of markets, trading and financial instruments
- name key facts related to the historical return and risk of bond and equity markets
- relate key facts of the managed fund industry
- define market microstructure and evaluate its importance to investors
- explain the fundamental drivers of diversification as an investment strategy for investors

ELIGIBILITY CRITERIA AND STRUCTURE

Any graduate shall be eligible for the admission to the course.

CERTIFICATION:

The candidates successfully qualification

The course shall be awarded a certificate to that effect in the appropriate form by School of Commerce and Business Management, Department of Commerce, PRIST University, Thanjavur-Vallam.

Handwritten signature
DEAN
School of Commerce and Management
Ponnaiyah Ramajayam Institute of
Science & Technology (PRIST)
THANJAVUR - 613 403.



Academic year: 2023-2024

Course: Certificate Course in Investment Management

Subject Code: 2261IM

AIMS: To emphasis Better performance in Sales and Marketing.

OBJECTIVES:

- provide an overview of historical trends and innovations in financial instruments and trading processes
- provide an overview of various financial instruments
- provide insight into the use of finance theory in investment management
- provide an overview of historical trends and innovations in financial instruments and trading processes
- provide an overview of various financial instruments
- provide insight into the use of finance theory in investment management

OUTCOMES:

- contrast key characteristics of given financial instruments • briefly recall important historical trends in the innovation of markets, trading and financial instruments
- name key facts related to the historical return and risk of bond and equity markets
- relate key facts of the managed fund industry
- define market microstructure and evaluate its importance to investors
- explain the fundamental drivers of diversification as an investment strategy for investors

UNIT I

Investment Management - Nature and scope - Objectives – Process – Investment Media Security and Non-security forms of Investment - gilt edged securities – Sources of Investment information.

UNIT II

New Issues Market – Methods of Issuing – Parties involved in the new issue market – Secondary market – Stock Exchanges – NSE and BSE – Trading mechanism – online trading – SEBI and Investors production.

UNIT III

Security Analysis – Approaches – Fundamental Analysis – Technical Analysis – Dow Theory – Random Walk Theory – Efficient Market Hypothesis.

UNIT IV

Portfolio Analysis – Traditional and Modern approach – Rationale of Diversification of Investments – Markowitz theory – Sharpe Index Model - Capital Asset Pricing Model.

UNIT V

Investment companies in India – Types Mutual Fund Operations in India – UTI – SEBI and RBI Guidelines for Mutual Funds.

TEXT BOOKS RECOMMENDED:

1. Asthana, D. K., and Asthana, Meera, Environmental Problems and Solutions, S. Chand, New Delhi, 2012.
2. Bajpai, Asha, Child Rights in India, Oxford University Press, New Delhi, 2010.
3. Bhatnagar Mamta and Bhatnagar Nitin, Effective Communication and Soft Skills, Pearson India, New Delhi, 2011.
4. G Subba Rao, Writing Skills for Civil Services Examination, Access Publishing, New Delhi, 2014 5. Kaushal, Rachan

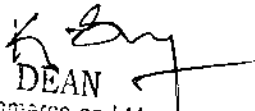

HOD
Department of Business Management
Ponnaiyah Ramajayam Institute of
Science & Technology (PRIIST)
THANJAVUR - 613 403.

DEAN
School of Commerce and Management
Ponnaiyah Ramajayam Institute of
Science & Technology (PRIIST)
THANJAVUR 613 403.

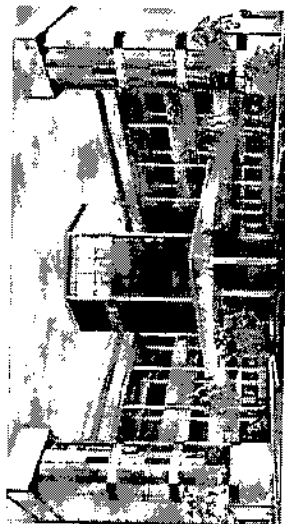

**PONNAIYAH RAMAJAYAM INSTITUTE OF
SCIENCE & TECHNOLOGY (PRIST)**

Declared as DEEMED TO BE UNIVERSITY
U/a 3 of UGC Act, 1956



ADD -ON COURSES

CERTIFICATE COURSE

IN

BUSINESS WRITING

2023-2024

[Signature]
HOD
Department of Business Management
Ponnaiyah Ramajayam Institute of
Science & Technology (PRIST)
THANJAVUR-613 403.

ABOUT UNIVERSITY:

PRIST University, Ponnaiyah Ramajayam Institutions, made a foray into the Academic Domain, with the establishment of Sri Ram Institute of Computer Science and Technology in 1985. Over time, various institutions of higher learning such as Arts and Science College, commerce and business management College of Engineering and Technology, College of Education, Research Institution, Polytechnic college are added feathers to the PRIST crown.

DEPARTMENT OF MANAGEMENT

The department of commerce and business management was established in the year 2008, with commerce Dept focused on research and education different courses like Undergraduate/Postgraduate/M.Phil and Ph.D programs offered. In this department there are 19 faculty members (Professor, Associate and Assistant Professor The faculty offers B.Com, BBA, M.Com, MBA and research programmes in Accountancy, Finance, Business administration, Banking & Business Economics, Human Resource Management, Marketing Management, Retail Management, Family Business & Entrepreneurship etc.

APPLICATION FORM:

1. FULL NAME _____
2. PROGRAMME _____
3. DISCIPLINE _____
4. INSTITUTION NAME _____
5. DATE-OFBIRTH _____
6. SEX(F/M) _____
7. E-MAIL _____
8. MOBILE NO _____
9. ADDRESS _____

Signature of the Applicant

SUBMISSION OF APPLICATION FORM

Submit your application form in person to the coordinators, school of commerce and Business and Management. PRIST University Thanjavur, vallam,-613403.

APPLICATION MAY BE SEND TO

COURSE CO-ORDINATOR:

Dr.T.J.Jayasholam

Head of the department

PRIST University,Thanjavur,Thanjavur.

[Signature]
DEAN
School of Commerce and Management
Ponnaiyah Ramajayam Institute of
Science & Technology (PRIST)
THANJAVUR-613 403.

INTRODUCTION

Business writing is a type of writing that is used in a professional setting. It is a purposeful piece of writing that conveys relevant information to the reader in a clear, concise, and effective manner. It includes client proposals, reports, memos, emails, and notices.

IMPORTANCE OF BUSINESS WRITING

Learning and honing business writing skills can have a positive impact on an individual's career advancement.

Effective communication makes an organization run smoothly. Professional writing improves productivity and the ability of all functional areas to work together, particularly in an increasingly global workplace where collaboration is the norm. Understanding the importance of business writing will help you improve your skills in this very important management area.

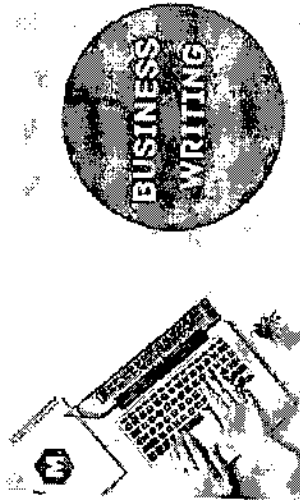

OBJECTIVES OF PROGRAM

Effective writing is often a critical success factor when it comes to presenting business cases in the workplace. An estimated 30% of all business communication is aimed at clarifying miscommunication generated from the other 70%! This realization ~~has resulted~~ ^{has resulted} in business

Department of Business Management
Ponnaiyah Ramajayam Institute of
Science & Technology (PRIST)
THANJAVUR - 613 403.

writing skills training becoming essential for capability development initiatives. This training course will describe and apply structuring and business writing techniques designed to cater for the modern business environment.

DURATION OF PROGRAM

45 Hours add on certificate course

PROGRAM OUTCOME

- A clear understanding of how to plan and structure business writing in a professional manner
- Practice in building the introduction, the main body, and the conclusion of an effective business communication
- The ability to compile the writing in a logical sequence
- A guide to help recognize, and eliminate, common errors in business writing
- The ability to focus on the main purpose of the communication
- The skills to maintain clarity in preparing business communication

ELIGIBILITY CRITERIA AND FEE

STRUCTURE

Any graduate shall be eligible for the admission to the course .

CERTIFICATION:

The candidates successfully qualified the course shall be awarded a certificate to that effect in the appropriate form by school of commerce and Business Management, Department of Commerce, PRIST University Thanjavur, Vallam.

DEAN
School of Commerce and Management
Ponnaiyah Ramajayam Institute of
Science & Technology (PRIST)
THANJAVUR - 613 403.

COURSE: CERTIFICATES IN BUSINESS WRITTING

Subject Code: 2021CCBW

AIMS: To emphasis better performance than the overall Business writing

Objectives:

- After successfully completing this week's activities, you should be able to:
Apply knowledge of sentence grammar to produce effective, correct, and rhetorically appropriate sentence constructions.
- Identify personal areas for improvement in common grammar, punctuation, and syntax errors.

OUTCOMES:

- The ability to compile the writing in a logical sequence. A guide to help recognize, and eliminate, common errors in business writing.
- The ability to focus on the main purpose of the communication. The skills to maintain clarity in preparing business communication.

UNIT-1

Business Writing Fundamentals

- What is "business English?"
- Sentence grammar and punctuation
Sentence fluency

UNIT-2

Genres of Office Communication

- You-attitude and the rhetorical situation
- Basic document design

UNIT-3

Workplace Communication Case Study: Research Set-up

- Proposals in business writing
- Ethics in professional research

UNIT-4

Workplace Communication Case Study: Written Report

- Features, purposes, and design of short reports

UNIT-5

- Short Reports: Features, Purposes, and Design prerecorded mini lecture



Department of Business Management
Ponnaiyah Ramajayam Institute of
Science & Technology (PRTST)
THANJAVUR-613 403.



DEAN
School of Commerce and Management
Ponnaiyah Ramajayam Institute of
Science & Technology (PRTST)
THANJAVUR-613 403.



**PONNAIYAH RAMAJAYAM INSTITUTE OF
SCIENCE & TECHNOLOGY (PRIST)**

Declared as DEEMED TO BE UNIVERSITY
U/s 3 of UGC Act, 1956



ADD-ONCOURSES

EVEN-SEM Certificate Course In Transport and Logistics

2023-2024

HOD

Department of Business Management,
Ponnaiyah Ramajayam Institute of
Science & Technology (PRIST)
THANJAVUR - 613 403.

ABOUTUNIVERSITY:

PRIST Deemed to be University, Ponnaiyah Ramajayam Institutions, made a for any into the Academic Domain ,with the establishment of Sri Ram Institute of Computer Science and Technology in 1985. Over time, various institution so higher learning such as Arts and Science College, commerce and business management College of Engineering and Technology, College of Education, Research Institution, Polytechnic college are added feathers to the PRIST crown.

DEPARTMENTOF MANAGEMENT

The department of commerce and Business management was established in the year 2008, with commerce Department focused on research and education different courses like Undergraduate/Postgraduate/M.Phil and Ph.D programs offered. In this department there are 19 faculty members (Professor, Associate and Assistant Professor The faculty offers B.Com, BBA, M.Com, MBA and research programmers in Accountancy, Finance, Business administration, Banking & Business Economics, Human Resource Management, Marketing Management, Retail Management, Family Business & Entrepreneurship etc.

APPLICATIONFORM

1. FULL NAME _____
2. PROGRAMME _____
3. DISCIPLINE _____
4. INSTITUTIONNAME _____
5. DATE-OFBIRTH _____
6. SEX(F/M) _____
7. E-MAIL _____
8. MOBILENO _____
9. ADDRESS _____

Signature of the Applicant

SUBMISSION OF APPLICATION FORM

Submit your application form in person to the coordinators, school of commerce and Business and Management. PRIST Deemed to be University, vallam, Thanjavur - 613403.

APPLICATIONMAYBESENDTO COURSE

CO- ORDINATOR:

Mrs. K.SATHYA,

Dean(i/c) of Commerce and Management

PRIST University, Thanjavur,

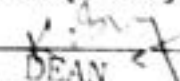
DEAN

School of Commerce and Management
Ponnaiyah Ramajayam Institute of
Science & Technology (PRIST)
THANJAVUR - 613 403



**PONNAIYAH RAMAJAYAM INSTITUTE OF
SCIENCE & TECHNOLOGY (PRIST)**

Declared as DEEMED TO BE UNIVERSITY
Uis 3 of USC Act, 1956

ADD-ONCOURSES

**EVEN-SEM
Certificate Course
In
Transport and Logistics**

2023-2024



HOD

Department of Business Management
Ponnaiyah Ramajayam Institute of
Science & Technology (PRIST)
THANJAVUR-613 403.

INTRODUCTION

Planning, executing, and controlling the movement and storage of goods is the function of logistics, a component of supply chain management. The quality in the logistics and transport functions has a direct impact on the operating performance of an organization..

IMPORTANCE OF TRANSPORT AND LOGISTICS:

Transportation is a crucial part of logistics because it's responsible for moving products from the provider to the buyer. It's a key component of the supply chain, connecting suppliers, producers, and consumers.

OBJECTIVES OF PROGRAM

Logistics management minimizes operational costs by optimizing the movement and storage of goods. It achieves this through efficient route planning, reducing transportation expenses, and consolidating shipments to lower freight costs.

DURATION OF PROGRAM

45Hours add on certificate course

PROGRAM OUTCOME

PO1-A Transportation Management System (TMS) is an efficient tool that allows businesses to optimize all their logistics processes.

PO2-It is a crucial element of any supply chain management system

ELIGIBILITY CRITERIA AND FEES STRUCTURE:

Any graduate shall be eligible for the admission to the course.

CERTIFICATION:

The candidates success fully qualification

The course shall be awarded a certificate to that effect in the appropriate form by School of Commerce and Business Management, Department of Commerce, PRIST Deemed to be University, Thanjavur- Vallam.

DEAN

School of Commerce and Management
Ponnaiyah Ramajayam Institute of
Science & Technology (PRIST)
THANJAVUR-613 403.



**PONNAIYAH RAMAJAYAM INSTITUTE OF
SCIENCE & TECHNOLOGY (PRIST)**

Declared as DEEMED TO BE UNIVERSITY
U/s 3 of UGC Act, 1956

2023-2024

Certificate Course In Transport And Logistics

Course code- 2361CCTL

AIM:

The primary goal of logistics management is to provide better customer service.

OBJECTIVE:

- Logistics management minimizes operational costs by optimizing the movement and storage of goods.
- It achieves this through efficient route planning, reducing transportation expenses, and consolidating shipments to lower freight costs.

UNIT:1

Introduction Logistics meaning – Warehouse Meaning - Types -Benefits of Warehousing. Transportation - Meaning - Types-Benefits. Courier/Express-Meaning-Courier Guidelines Pricing in Courier Express-Reverse logistics in e-commerce sector- Importance-Elements of effective E- commerce reverse logistics.

UNIT2:

Global Logistics 10 Hours Global Supply Chain-Organizing for Global Logistics-Strategic issues in Global Logistics- Financial issues in logistics Performance.

UNIT3:

Inventor 10 Hours Meaning - Need of Inventory-Types of Inventories-Basic EOQ Model- ABC analysis - Material Requirement Planning (MRP)-meaning and Advantages Materials handling and storage systems-Principles of Materials Handling.

UNIT4:

Warehousing &Distribution Operations 10 Hours Need for Warehouse - Importance of warehouse- Warehouse management process Safety measures of warehouse

UNIT 5:

Supply chain Concepts of retail logistics and supply chain - Efficiency of supply chain - Importance of Supply chain Management - Concept of Supply Chain management - Supply Chain strategy- Strategic drivers of supply chain performance.

HOD
Department of Business Management
Ponnaiyah Ramajayam Institute of
Science & Technology (PRIST)
TIRUNJAVUR-613 433.

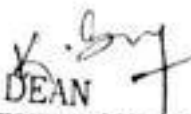
DEAN
School of Commerce and Management
Ponnaiyah Ramajayam Institute of
Science & Technology (PRIST)
TIRUNJAVUR-613 403.



PONNAIYAH RAMAJAYAM INSTITUTE OF
SCIENCE & TECHNOLOGY (PRIST)

GRANTED BY DEEMED TO BE UNIVERSITY
U.S. 3 of 2002 Act, 1958



ADD-ONCOURSES

**Certificate Course
in
Financial risk Management**

2023-2024

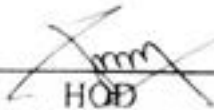
HOD

Department of Business Management
Ponnaiyah Ramajayam Institute of
Science & Technology (PRIST)
THANJAVUR - 613 403.

ABOUTUNIVERSITY:

PRIST Deemed to be University, Ponnaiyah Ramajayam Institutions ,made a for any in to the Academic Domain, with the establishment of Sri Ram Institute of Computer Science and Technologyin 1985. Over time, various institution so higher learning such as Arts and Science College, commerce and business management College of Engineering and Technology, College of Education, Research Institution, Polytechnic college are added feathers to the PRIST crown.

DEPARTMENTOF MANAGEMENT

The department of commerce and business management was established in the year 2008, with commerce Dept focused on research and education different courses like Undergraduate/Postgraduate/M.Phil and Ph.D programs offered. In this department thereare19 faculty members (Professor, Associate and Assistant Professor The faculty offersB.Com, B.Com CA BBA, M.Com, MBA and research programs in Accountancy, Finance, Business administration, Banking & Business Economics, Human Resource Management, Marketing Management, Retail Management, Family Business & Entrepreneurship etc.

APPLICATIONFORM

1. FULL NAME _____
2. PROGRAMME _____
3. DISCIPLINE _____
4. INSTITUTIONNAME _____
5. DATE-OFBIRTH _____
6. SEX(F/M) _____
7. E-MAIL _____
8. MOBILENO _____
9. ADDRESS _____

Signature of the Applicant

SUBMISSIONOFAPPLICATIONFORM

Submit your application form in person to the coordinators, school of commerce and Business and Management. PRIST Deemed to be University Thanjavur, vallam,-613403.

APPLICATIONMAYBESENDTO COURSE

CO- ORDINATOR:
Mrs. K.SATHYA,
Dean(i/c) of Commerce and Management
PRIST University, Thanjavur,

DEAN

School of Commerce and Management
Ponnaiyah Ramajayam Institute of
Science & Technology (PRIST)
THANJAVUR - 613 403.



PONNAIYAH RAMAJAYAM INSTITUTE OF
SCIENCE & TECHNOLOGY (PRIST)

Declared as DEEMED TO BE UNIVERSITY
Via 3 of UGC Act, 1956

ADD -ON COURSES

**Certificate Course
in
Financial risk Management**

2023-2024

Financial Risk Management



HOD

Department of Business Management
Ponnaiyah Ramajayam Institute of
Science & Technology (PRIST)
THANJAVUR - 613 403.

INTRODUCTION

Financial risk management is the process of identifying, analyzing, and reducing the impact of financial risks on an organization. The goal is to protect a company's value and earnings potential while : support growth..

IMPORTANCE OF FINANCIAL RISK MANAGEMENT:

Financial risk management is important because it helps businesses prevent losses, improve financial performance, and maintain a competitive advantage. It can also help businesses adapt to market changes, maintain compliance, and protect their reputation.

OBJECTIVES OF PROGRAM

Financial risk management involves identifying the potential downsides in any investment decision and deciding whether to accept the risks or take measures to mitigate them. Financial risk management is a continuing process as risks can change over time..

DURATION OF PROGRAM

45Hours add on certificate course

PROGRAM OUTCOME

PO1-With a risk assessment carried out, your organization has a much clearer understanding of the required health and safety budget moving forward.
PO2-Knowing the severity and likelihood of a hazard will allow your organization to budget accordingly to control or eliminate found hazards.

ELIGIBILITY CRITERIA AND STRUCTURE

Any graduate shall be eligible for the admission to the course.

CERTIFICATION:

The candidates successfully qualification The course shall be awarded a certificate to that effect in the appropriate form by School of Commerce and Business Management, Department of Commerce, PRIST Deemed to be University, Thanjavur-Vallam.

DEAN

School of Commerce and Management
Ponnaiyah Ramajayam Institute of
Science & Technology (PRIST)
THANJAVUR - 613 403



PONNAIYAH RAMAJAYAM INSTITUTE OF
SCIENCE & TECHNOLOGY (PRIST)
DEPARTMENTAL DEEMED TO BE UNIVERSITY
DIL 744 1007 8-11-1998

2023-2024

Certificate Course In Financial Risk Management
Course code-2361CFRM

AIM: The primary goal of financial management is profit maximization.

Objective: To enable the students to know the principles and practices of managing finance.

Unit - I

Financial Management: Meaning and scope – Objectives: Profit maximization, Wealth maximization – Functions – Financial decisions – Time value of money: Present value and Compound value – Cost of capital – Cost of debt – Cost of preference share capital – Cost of equity – Cost of retained earnings – Weighted average cost of capital.

Unit - II

Capital structure – Meaning and features – Factors determining capital structure – EBITEPS relationship – Indifference point of EBIT – Theories of capital structure: Net income approach, Net operating income approach, MM approach and Traditional approach.

Unit - III

Leverage – Meaning, significance and types – Operating leverage - Financial leverage – Combined leverage – Dividend policy – Determinants of dividend policy – Theories: relevance and irrelevance with value of firm – Forms of dividend – Stock dividend – Bonus issue – Stable dividend.

Unit - IV

Working capital management – Determinants of working capital – Forecasting of working capital requirements – Cash management – Motives of holding cash – Stages in cash management: Cash planning, Collection and disbursement of cash, Optimum cash balance – Boumul model – Investment of surplus cash.

Unit - V

Receivables management – Objectives – Factors influencing size of receivables – Credit policy – Credit standard – Credit term – Collection policy – Incremental analysis – Inventory management – Meaning – Types of inventory – Purpose of holding inventory – Excess or inadequate inventory – EOQ – Levels of stock: reorder level, minimum level and maximum level – Techniques – ABC, VED, FSN and HML analysis.

Theory: 20% Problem: 80%

Text and Reference Books (Latest revised edition only)

1. Elements of financial management by S.N.Maheswari – Sultan Chand & Sons., New Delhi
2. Financial Management by R.K.Sharma – Kalyani publishers, New Delhi
3. Financial Management by R.Ramachandran&R.Srinivasan – Sriram publication, Trichy
4. Theory and Problems of Financial management by Khan & Jain, McGraw Hill Publication, New Delhi
5. Financial Management by S.P.Guptha, SahityaBhavan Publication, New Delhi

HOD
Department of Business Management
Ponnaiyah Ramajayam Institute of
Science & Technology (PRIST)
THANJAVUR-613 403.

DEAN
School of Commerce and Management
Ponnaiyah Ramajayam Institute of
Science & Technology (PRIST)
THANJAVUR-613 403.



**PONNAIYAH RAMAJAYAM INSTITUTE OF
SCIENCE & TECHNOLOGY (PRIST)**
Deemed as University by UGC Act 1956
UFS 3 of 1996 Act 1996

2023-2024
STUDENTS ATTENDANCE
DIPLOMA IN E-BANKING

S.NO	REG.NO	NAME	20/07/2023	21/07/2023	24/07/2023	25/07/2023	26/07/2023	27/07/2023	28/07/2023	31/07/2023
1	2201BM10101	E. VISHWANATHAN	P	P	P	P	P	P	P	P
2	2201BM10102	H. KHALID SULAIMAN	P	P	P	P	P	P	P	P
3	2201BM10103	MUKESH CHANDRAN	P	P	P	P	P	P	P	P
4	2201BM10104	C. HARI RAM	P	P	P	P	P	P	P	P
5	2201BM10105	K. DINESH KUMAR	P	P	P	P	P	P	P	P
6	2201BM10107	P.L. KAVYARASU	P	P	P	P	P	P	P	P
7	2201BM10108	S. SIVA SHANKAR	P	P	P	P	P	P	P	P
8	2201BM10109	R. SEYYAD ABTHAKIR	P	P	P	P	P	P	P	P
9	2201BM10110	ASHWIN VASANTH	P	P	P	P	P	P	P	P
10	2201BM10111	R. RAJ	P	P	P	P	P	P	P	P
11	2201BM10112	S. NAVEENKUMAR	P	P	P	P	P	P	P	P
12	2201BM10113	V. MANIKANDAN	P	P	P	P	P	P	P	P
13	2201BM10114	THATCHITH	P	A	P	P	P	P	P	P
14	2201BM10201	M. MEENATCHI	P	P	P	P	P	A	P	P
15	2201BM10202	LURTHUASHIBA MARY	P	P	P	P	P	P	P	P
16	2201BM10203	PRASHANTH. M. S	P	P	P	P	P	P	P	P
17	2201BM10204	SHALINI. S	P	P	P	P	P	P	P	P
18	2201BM10205	SANTHOSH R	P	P	P	P	P	P	P	P
19	2201BM10206	PAVITHRA. R	P	P	P	P	P	P	P	P
20	2201BM10207	GOWTHAMS	P	P	P	P	P	P	P	P
21	2201BM10208	VAISALID	P	P	P	P	P	P	P	P
22	2201BM10209	ABINASH. R	P	P	P	P	P	P	P	P
23	2201BM10210	ABDULLA. A	P	P	P	P	P	P	P	P
24	2201BM10211	MANIJKERTHANAK	P	P	P	P	P	P	P	P
25	2201BM10212	MUKILANM	P	P	P	P	P	P	P	P
26	2201BM10213	PRAVEEN P	P	P	P	P	P	P	P	P
27	2201BM10214	MOHAMED IDRIZ S	P	P	P	P	P	P	P	P
28	2201BM10215	PRAVEENAD	P	P	P	P	P	P	P	P
29	2201BM10216	VJAY J	P	P	P	P	P	P	P	P
30	2201BM10217	VENGATESH R	P	P	P	P	P	P	P	P
31	2201BM10218	SHALINI S	P	P	P	P	P	P	P	P
32	2201BM10219	NIVYAA	P	P	P	P	P	P	P	P
33	2201BM10220	MOHAMED ARSHATH ALI	P	P	P	P	P	P	P	P
34	2201BM10221	MOHAMED AALITH M	P	P	P	P	P	P	P	P
35	2201BM10222	VINOOTHAR	P	P	P	P	P	P	P	P



**PONNAIYAH RAMAJAYAM INSTITUTE OF
SCIENCE & TECHNOLOGY (PRIST)**
Declared as Affiliated to Bharathidasan University
U/S of HOD Act, 1956

36	2201BM10223	ABIRAMI G	P	P	P	P	P	P	P	P	P	P	P	P	P	P	P	P	P
37	2201BM10224	SANTHOSH R	P	D	P	P	P	P	P	P	P	P	P	P	P	P	P	P	P
38	2201BM10225	YUVARAJ M	P	P	P	P	P	P	P	P	P	P	P	P	P	P	P	P	P
39	2201BM10226	MANOJKUMAR S	P	P	P	P	P	P	P	P	P	P	P	P	P	P	P	P	P
40	2201BM10227	NANDHAKUMAR M	P	P	P	P	P	P	P	P	P	P	P	P	P	P	P	P	P
41	2201BM10228	VINOTHINI P	P	P	P	P	P	P	P	P	P	P	P	P	P	P	P	P	P
42	2201BM10229	RAMNAITH K	P	P	P	P	P	P	P	P	P	P	P	P	P	P	P	P	P
43	2201BM10230	ARUNA K	P	P	P	P	P	P	P	P	P	P	P	P	P	P	P	P	P
44	2201BM10231	MARIYAMMAL R	P	P	P	P	A	P	P	P	P	P	P	P	P	P	P	P	P
45	2201BM10232	PARVIN RAJ S	P	P	P	P	P	P	P	P	P	P	P	P	P	P	P	P	P
46	2201BM10233	SIVARAMJANI D	P	P	P	P	P	P	P	P	P	P	P	P	P	P	P	P	P
47	2201BM10234	MOHAMED MASEHUDEEN M K	P	A	P	P	P	P	P	P	P	P	P	P	P	P	P	P	P
48	2201BM10235	KARUNAKARAN S	P	P	P	P	P	P	P	P	P	P	P	P	P	P	P	P	P

[Signature]
Department of Business Management
Ponnaiyah Ramajayam Institute of
Science & Technology (PRIST)
THANJAVUR-613 403.

[Signature]
School of Controller and Management
Ponnaiyah Ramajayam Institute of
Science & Technology (PRIST)
THANJAVUR-613 403.



**PONNAIYAH RAMAJAYAM INSTITUTE OF
SCIENCE & TECHNOLOGY (PRIST)**
Declared as O.I.E.M.U. 10 RE UNIVERSITY
U/G of UGC Act 1956

S.NO	REG.NO	NAME	02/08/2023	03/08/2023	04/08/2023	08/08/2023	09/08/2023	10/08/2023	14/08/2023	18/08/2023
1.	2201BM10101	E. VISHWANATHAN	P	P	P	P	P	P	P	P
2.	2201BM10102	H. KHALID SULAIMAN	P	P	P	P	P	P	P	P
3.	2201BM10103	MUKESH CHANDRAN	P	P	P	P	P	P	P	P
4.	2201BM10104	C. HARI RAM	P	P	P	P	P	P	P	P
5.	2201BM10105	K. DINESH KUMAR	P	P	P	P	P	P	P	P
6.	2201BM10107	P. L. KAVIYARASU	P	P	P	P	P	P	P	P
7.	2201BM10108	S. SIVA SHANKAR	P	P	P	P	P	P	P	P
8.	2201BM10109	R. SEYYAD ABTHAKIR	P	P	P	P	P	P	P	P
9.	2201BM10110	ASHWIN VASANTH	P	P	P	P	P	P	P	P
10.	2201BM10111	R. RAJ	P	P	P	P	P	P	P	P
11.	2201BM10112	S. NAVEENKUMAR	P	P	P	P	P	P	P	P
12.	2201BM10113	V. MANIKANDAN	P	P	P	P	P	P	P	P
13.	2201BM10114	THATCHITH	P	A	P	P	P	P	P	P
14.	2201BM10201	M. MEENATCHI LURTHUASHIBA	P	P	P	P	P	P	A	P
15.	2201BM10202	MARY	P	P	P	P	P	P	P	P
16.	2201BM10203	PRASHANTH. M. S	P	P	P	P	P	P	P	P
17.	2201BM10204	SHALINI. S	P	P	P	P	P	P	P	P
18.	2201BM10205	SANTHOSH R	P	P	P	P	P	P	P	P
19.	2201BM10206	PAVITTHA. R	P	P	P	P	P	P	P	P
20.	2201BM10207	GOWTHAMS	P	P	P	P	P	P	P	P
21.	2201BM10208	VAISALID	P	P	P	P	P	P	P	P
22.	2201BM10209	ABINASH. R	P	P	P	P	P	P	P	P
23.	2201BM10210	ABDULLA. A MANIUKERTHANA	P	P	P	P	P	P	P	P
24.	2201BM10211	K	P	P	P	P	P	P	P	P
25.	2201BM10212	MUKILAN M	P	P	P	P	P	P	P	P
26.	2201BM10213	PRAVEEN P	P	P	P	P	P	P	P	P
27.	2201BM10214	MOHAMED IDRIZ S	P	P	P	P	P	P	P	P
28.	2201BM10215	PRAVEENA D	P	P	P	P	P	P	P	P
29.	2201BM10216	VDAY J	P	P	P	P	P	P	P	P
30.	2201BM10217	VENGATESH R	P	P	P	P	P	P	P	P
31.	2201BM10218	SHALINI S	P	P	P	P	P	P	P	P
32.	2201BM10219	NIVYAA MOHAMED ARSHATH	P	P	P	P	P	P	P	P
33.	2201BM10220	ALI J	P	P	P	P	P	P	P	P



**PONNAIYAH RAMAJAYAM INSTITUTE OF
SCIENCE & TECHNOLOGY (PRIST)**
Declared as DEEMED TO BE UNIVERSITY
U/S 3 of UGC Act, 1956

34.	2201BM10221	MOHAMED AALITH M	P	P	P	P	P	P	P	P	P	P	P
35.	2201BM10222	VINOTHAR	P	P	P	P	P	P	P	P	P	P	P
36.	2201BM10223	ABIRAMI G	P	P	P	P	P	P	P	P	P	P	P
37.	2201BM10224	SANTHOSH R	P	P	P	P	P	P	P	P	P	P	P
38.	2201BM10225	YUVARAJ M	P	P	P	P	P	P	P	P	P	P	P
39.	2201BM10226	MANOJKUMAR S	P	P	P	P	P	P	P	P	P	P	P
40.	2201BM10227	NANDHAKUMAR M	P	P	P	P	P	P	P	P	P	P	P
41.	2201BM10228	VINOTHINI P	P	P	P	P	P	P	P	P	P	P	P
42.	2201BM10229	RAMNATH K	P	P	P	P	P	P	P	P	P	P	P
43.	2201BM10230	ARUNA K	P	P	P	P	P	P	P	P	P	P	P
44.	2201BM10231	MARIYAMMAL R	P	P	P	A	P	P	P	P	P	P	P
45.	2201BM10232	PARVIN RAJ S	P	P	P	P	P	P	P	P	P	P	P
46.	2201BM10233	SIVARANJANI D	P	P	P	P	P	P	P	P	P	P	P
47.		MOHAMED	P	A	P	P	P	P	P	P	P	P	P
48.	2201BM10234	MASEEHUDEEN M K											
	2201BM10235	KARUNAKARAN S	P	P	P	P	P	P	P	P	P	P	P

Department of Business Management
 Ponnaiyah Ramajayam Institute of
 Science & Technology (PRIST)
 THANJAVUR - 613 403.

DEAN
 School of Commerce and Management
 Ponnaiyah Ramajayam Institute of
 Science & Technology (PRIST)
 THANJAVUR - 613 403.



**PONNAIYAH RAMAJAYAM INSTITUTE OF
SCIENCE & TECHNOLOGY (PRIST)**
Declared as OIETMIL-10 BY UNIVERSITY
On 3 of Oct. 2019

S.NO	REG.NO	NAME	21/08/2023	22/08/2023	04/09/2023	05/09/2023	06/09/2023	08/09/2023	12/09/2023	14/09/2023
1.	2201BM10101	E.VISHWANATHAN	P	P	P	P	P	P	P	P
2.	2201BM10102	H.KHALID SULAIMAN	P	P	P	P	P	P	P	P
3.	2201BM10103	MUKESH CHANDRAN	P	P	P	P	P	P	P	P
4.	2201BM10104	C.HARI RAM	P	P	P	P	P	P	P	P
5.	2201BM10105	K.DINESH KUMAR	P	P	P	P	P	P	P	P
6.	2201BM10107	P.L.KAVIYARASU	P	P	P	P	P	P	P	P
7.	2201BM10108	S.SIVA SHANKAR	P	P	P	P	P	P	P	P
8.	2201BM10109	R.SETTYAD ABTHAKIR	P	P	P	P	P	P	P	P
9.	2201BM10110	ASHWIN VASANTH	P	P	P	P	P	P	P	P
10.	2201BM10111	R. RAJ	P	P	P	P	P	P	P	P
11.	2201BM10112	S.NAVENKUMAR	P	P	P	P	P	P	P	P
12.	2201BM10113	V.MANIKANDAN	P	P	P	P	P	P	P	P
13.	2201BM10114	THATCHITH	P	A	P	P	P	P	P	P
14.	2201BM10201	M.MEENATCHI LURTHUASHIBA	P	P	P	P	P	A	P	P
15.	2201BM10202	MARY	P	P	P	P	P	P	P	P
16.	2201BM10203	PRASHANTH.M.S	P	P	P	P	P	P	P	P
17.	2201BM10204	SHALINI.S	P	P	P	P	P	P	P	P
18.	2201BM10205	SANTHOSH R	P	P	P	P	P	P	P	P
19.	2201BM10206	PAVITHRA.R	P	P	P	P	P	P	P	P
20.	2201BM10207	GOWTHAM S	P	P	P	P	P	P	P	P
21.	2201BM10208	VAISALID	P	P	P	P	P	P	P	P
22.	2201BM10209	ABDINASH.R	P	P	P	P	P	P	P	P
23.	2201BM10210	ABDULLA.A MANJUKKEERTHANA	P	P	P	P	P	P	P	P
24.	2201BM10211	K	P	P	P	P	P	P	P	P
25.	2201BM10212	MUKILAN M	P	P	P	P	P	P	P	P
26.	2201BM10213	PRAVEEN P	P	P	P	P	P	P	P	P
27.	2201BM10214	MOHAMED IDRRIZ S	P	P	P	P	P	P	P	P
28.	2201BM10215	PRAVEENA D	P	P	P	P	P	P	P	P
29.	2201BM10216	VIJAY J	P	P	P	P	P	P	P	P
30.	2201BM10217	VENGATESH R	P	P	P	P	P	P	P	P
31.	2201BM10218	SHALINI S	P	P	P	P	P	P	P	P
32.	2201BM10219	NIVYAA	P	P	P	P	P	P	P	P
33.	2201BM10220	MOHAMED ARSHATH ALI J	P	P	P	P	P	P	P	P



**PONNAIYAH RAMAJAYAM INSTITUTE OF
SCIENCE & TECHNOLOGY (PRIST)**
Declared as UEMED TO BE UNIVERSITY
DUE 3 of UGC Act, 1956

34.	2201BM10221	MOHAMED AALITH M	P	P	P	P	P	P	P	P	P	P	P	P	P	P	P	P	P
35.	2201BM10222	VINOTHAR	P	P	P	P	P	P	P	P	P	P	P	P	P	P	P	P	P
36.	2201BM10223	ABIRAMI G	P	P	P	P	P	P	P	P	P	P	P	P	P	P	P	P	P
37.	2201BM10224	SANTHOSH R	P	P	P	P	P	P	P	P	P	P	P	P	P	P	P	P	P
38.	2201BM10225	YUVARAJ M	P	P	P	P	P	P	P	P	P	P	P	P	P	P	P	P	P
39.	2201BM10226	MANOJKUMAR S	P	P	P	P	P	P	P	P	P	P	P	P	P	P	P	P	P
40.	2201BM10227	NANDHAKUMAR M	P	P	P	P	P	P	P	P	P	P	P	P	P	P	P	P	P
41.	2201BM10228	VINOTHINI P	P	P	P	P	P	P	P	P	P	P	P	P	P	P	P	P	P
42.	2201BM10229	RAMNATH K	P	P	P	P	P	P	P	P	P	P	P	P	P	P	P	P	P
43.	2201BM10230	ARUNA K	P	P	P	P	P	P	P	P	P	P	P	P	P	P	P	P	P
44.	2201BM10231	MARIYAMMAL J.R	P	P	P	P	P	P	P	P	P	P	P	P	P	P	P	P	P
45.	2201BM10232	PARVIN RAI S	P	P	P	P	P	P	P	P	P	P	P	P	P	P	P	P	P
46.	2201BM10233	SIVARANJANI D	P	P	P	P	P	P	P	P	P	P	P	P	P	P	P	P	P
47.	2201BM10234	MOHAMED MASEEHUDEEN M.K	P	A	P	P	P	P	P	P	P	P	P	P	P	P	P	P	P
48.	2201BM10235	KARUNAKARAN S	P	P	P	P	P	P	P	P	P	P	P	P	P	P	P	P	P

HOD
 Department of Business Management
 Ponnaiyah Ramajayam Institute of
 Science & Technology (PRIST)
 THANJAVUR - 613 403.

DEAN
 School of Commerce and Management
 Ponnaiyah Ramajayam Institute of
 Science & Technology (PRIST)
 THANJAVUR - 613 403.



**PONNAIYAH RAMAJAYAM INSTITUTE OF
SCIENCE & TECHNOLOGY (PRIST)**

DECLARED AS DEEMED TO BE UNIVERSITY
BY S.O. 1155, A.C.T. 1956

S.NO	REG.NO	NAME	18/09/2023	20/09/2023	21/09/2023	25/09/2023	27/09/2023	05/10/2023	10/10/2023	11/10/2023
1.	2201BM10101	E. VISHWANATHAN	P	P	P	P	P	P	P	P
2.	2201BM10102	H. KHALID SULAIMAN	P	P	P	P	P	P	P	P
3.	2201BM10103	MUKESH CHANDRAN	P	P	P	P	P	P	P	P
4.	2201BM10104	C. HARI RAM	P	P	P	P	P	P	P	P
5.	2201BM10105	K. DINESH KUMAR	P	P	P	P	P	P	P	P
6.	2201BM10107	P. L. KAVIYARASU	P	P	P	P	P	P	P	P
7.	2201BM10108	S. SIVA SHANKAR	P	P	P	P	P	P	P	P
8.	2201BM10109	R. SEYAD ABTHAKIR	P	P	P	P	P	P	P	P
9.	2201BM10110	ASHWIN VASANTH	P	P	P	P	P	P	P	P
10.	2201BM10111	R. RAJ	P	P	P	P	P	P	P	P
11.	2201BM10112	S. NAVEENKUMAR	P	P	P	P	P	P	P	P
12.	2201BM10113	V. MANJIKANDAN	P	P	P	P	P	P	P	P
13.	2201BM10114	THATCHITH	P	A	P	P	P	P	P	P
14.	2201BM10201	M. MEENATCHI	P	P	P	P	P	P	P	P
15.	2201BM10202	LURTHUASHIBA MARY	P	P	P	P	P	A	P	P
16.	2201BM10203	PRASHANTH. M.S	P	P	P	P	P	P	P	P
17.	2201BM10204	SHALINI. S	P	P	P	P	P	P	P	P
18.	2201BM10205	SANTHOSH R	P	P	P	P	P	P	P	P
19.	2201BM10206	PAVITHRA. R	P	P	P	P	P	P	P	P
20.	2201BM10207	GOWTHAM S	P	P	P	P	P	P	P	P
21.	2201BM10208	VAISALI D	P	P	P	P	P	P	P	P
22.	2201BM10209	ABINASH. R	P	P	P	P	P	P	P	P
23.	2201BM10210	ABDULLA. A	P	P	P	P	P	P	P	P
24.	2201BM10211	MANJUKERTHANA K	P	P	P	P	P	P	P	P
25.	2201BM10212	MUKILAN M	P	P	P	P	P	P	P	P
26.	2201BM10213	PRAVEEN P	P	P	P	P	P	P	P	P
27.	2201BM10214	MOHAMED IDRRIZ S	P	P	P	P	P	P	P	P
28.	2201BM10215	PRAVEENA D	P	P	P	P	P	P	P	P
29.	2201BM10216	VIJAY J	P	P	P	P	P	P	P	P
30.	2201BM10217	VENGATESH R	P	P	P	P	P	P	P	P
31.	2201BM10218	SHALINI S	P	P	P	P	P	P	P	P
32.	2201BM10219	NIVYAA	P	P	P	P	P	P	P	P
33.	2201BM10220	MOHAMED ARSHATH ALI J	P	P	P	P	P	P	P	P



**PONNAIYAH RAMAJAYAM INSTITUTE OF
SCIENCE & TECHNOLOGY (PRIST)**

Declarated as DEEMED TO BE UNIVERSITY
UFS 3 of UGC Act, 1956

34.	2201BM10221	MOHAMED AALITH M	P	P	P	P	P	P	P	P	P	P	P
35.	2201BM10222	VINOTHAR	P	P	P	P	P	P	P	P	P	P	P
36.	2201BM10223	ABIRAMI G	P	P	P	P	P	P	P	P	P	P	P
37.	2201BM10224	SANTHOSH R	P	P	P	P	P	P	P	P	P	P	P
38.	2201BM10225	YUVARAJ M	P	P	P	P	P	P	P	P	P	P	P
39.	2201BM10226	MANOJKUMAR S	P	P	P	P	P	P	P	P	P	P	P
40.	2201BM10227	NANDHAKUMAR M	P	P	P	P	P	P	P	P	P	P	P
41.	2201BM10228	VINOTHINI .P	P	P	P	P	P	P	P	P	P	P	P
42.	2201BM10229	RAMNATH K	P	P	P	P	P	P	P	P	P	P	P
43.	2201BM10230	ARUNA .K	P	P	P	P	P	P	P	P	P	P	P
44.	2201BM10231	MARIYAMMAL.R	P	P	P	A	P	P	P	P	P	P	P
45.	2201BM10232	PARVIN RAI .S	P	P	P	P	P	P	P	P	P	P	P
46.	2201BM10233	SIVARANJANI. D	P	P	P	P	P	P	P	P	P	P	P
47.		MOHAMED MASEEHUDEEN M	P	A	P	P	P	P	P	P	P	P	P
	2201BM10234	K											
48.	2201BM10235	KARUNAKARAN S	P	P	P	P	P	P	P	P	P	P	P

[Handwritten signatures and marks in the right margin]

HOD
Department of Business Management
Ponnaiyah Ramajayam Institute of
Science & Technology (PRIST)
THANJAVUR - 613 403.

DEAN
School of Commerce and Management
Ponnaiyah Ramajayam Institute of
Science & Technology (PRIST)
THANJAVUR - 613 403.



**PONNAIYAH RAMAJAYAM INSTITUTE OF
SCIENCE & TECHNOLOGY (PRIST)**

Incorporated as DEEMED-TO-BE-UNIVERSITY
U.T.S. 3 of 1996 Act, 1956

S.NO	REG.NO	NAME	12/10/2023	16/10/2023	17/10/2023	18/10/2023	19/10/2023	20/10/2023	06/11/2023	07/11/2023
1.	2201BM10101	E. VISHWANATHAN	P	P	P	P	P	P	P	P
2.	2201BM10102	H. KHALID SULAIMAN	P	P	P	P	P	P	P	P
3.	2201BM10103 2201BM10104	MUKESH CHANDRAN	P	P	P	P	P	P	P	P
4.	2201BM10105	C. HARI RAM	P	P	P	P	P	P	P	P
5.	2201BM10107	K. DINESH KUMAR	P	P	P	P	P	P	P	P
6.	2201BM10108	P. L. KAVIYARASU	P	P	P	P	P	P	P	P
7.	2201BM10109	S. SIVA SHANKAR	P	P	P	P	P	P	P	P
8.	2201BM10110	R. SEYYAD ABTHAKIR	P	P	P	P	P	P	P	P
9.	2201BM10111	ASHWIN VASANTH	P	P	P	P	P	P	P	P
10.	2201BM10112	R. RAJ	P	P	P	P	P	P	P	P
11.	2201BM10113	S. NAVEENKUMAR	P	P	P	P	P	P	P	P
12.	2201BM10114	V. MANIKANDAN	P	P	P	P	P	P	P	P
13.	2201BM10201	THATCHITHI	P	A	P	P	P	P	P	P
14.	2201BM10202	M. MEENATCHI	P	P	P	P	P	P	P	P
15.	2201BM10203	LURTHUASHIBA MARY	P	P	P	P	P	A	P	P
16.	2201BM10204	PRASHANTH. M. S	P	P	P	P	P	P	P	P
17.	2201BM10205	SHALINI. S	P	P	P	P	P	P	P	P
18.	2201BM10206	SANTHOSH R	P	P	P	P	P	P	P	P
19.	2201BM10207	PAVITHRA. R	P	P	P	P	P	P	P	P
20.	2201BM10208	GOWTHAM S	P	P	P	P	P	P	P	P
21.	2201BM10209	VAISALI D	P	P	P	P	P	P	P	P
22.	2201BM10210	ABINASH. R	P	P	P	P	P	P	P	P
23.	2201BM10211	ABDULLA. A	P	P	P	P	P	P	P	P
24.	2201BM10212	MANJUKEERTHANA K	P	P	P	P	P	P	P	P
25.	2201BM10213	MUKILAN M	P	P	P	P	P	P	P	P
26.	2201BM10214	PRAVEEN P	P	P	P	P	P	P	P	P
27.	2201BM10215	MOHAMED IDRIZ	P	P	P	P	P	P	P	P
28.	2201BM10216	S	P	P	P	P	P	P	P	P
29.	2201BM10217	PRAVEENA D	P	P	P	P	P	P	P	P
30.	2201BM10218	VIJAY J	P	P	P	P	P	P	P	P
31.	2201BM10219	VENGATESH R	P	P	P	P	P	P	P	P
32.	2201BM10220	SHALINI S	P	P	P	P	P	P	P	P
33.	2201BM10221	NIVYAA	P	P	P	P	P	P	P	P
		MOHAMED ARSHATH ALI J	P	P	P	P	P	P	P	P



**PONNAIYAH RAMAJAYAM INSTITUTE OF
SCIENCE & TECHNOLOGY (PRIST)**

DECEMBER 25, 1966 (M.D.) - BE UNIVERSITY
1178, 31 of 1966, Act, 1956

S.NO	REG.NO	NAME	12/12/2023	13/12/2023	14/12/2023	15/12/2023	18/12/2023
1.	2201BM10101	E. VISHWANATHAN	P	P	P	P	P
2.	2201BM10102	H. KHALID SULAIMAN	P	P	P	P	P
3.	2201BM10103	MUKESH CHANDRAN	P	P	P	P	P
4.	2201BM10104	C. HARI RAM	P	P	P	P	P
5.	2201BM10105	K. DINESH KUMAR	P	P	P	P	P
6.	2201BM10107	P. L. KAVIYARASU	P	P	P	P	P
7.	2201BM10108	S. SIVA SHANKAR	P	P	P	P	P
8.	2201BM10109	R. SEYYAD ABTHAKIR	P	P	P	P	P
9.	2201BM10110	ASHWIN VASANTH	P	P	P	P	P
10.	2201BM10111	R. RAJ	P	P	P	P	P
11.	2201BM10112	S. NAVEENKUMAR	P	P	P	P	P
12.	2201BM10113	V. MANIKANDAN	P	P	P	P	P
13.	2201BM10114	THATCHITH	P	P	P	P	P
14.	2201BM10201	M. MEENATCHI	P	P	P	P	P
15.	2201BM10202	LURTHUASHIBA MARY	P	P	P	P	P
16.	2201BM10203	PRASHANTH. M.S	P	P	P	P	P
17.	2201BM10204	SHALINI. S	P	P	P	P	P
18.	2201BM10205	SANTHOSH R	P	P	P	P	P
19.	2201BM10206	PAVITHRA. R	P	P	P	P	P
20.	2201BM10207	GOWTHAM S	P	P	P	P	P
21.	2201BM10208	VAISALI D	P	P	P	P	P
22.	2201BM10209	ABINASH. R	P	P	P	P	P
23.	2201BM10210	ABDULLA. A	P	P	P	P	P
24.	2201BM10211	MANJUKEERTHANA K	P	P	P	P	P
25.	2201BM10212	MUKILAN M	P	P	P	P	P
26.	2201BM10213	PRAVEEN P	P	P	P	P	P
27.	2201BM10214	MOHAMED IDRRIZ S	P	P	P	P	P
28.	2201BM10215	PRAVEENA D	P	P	P	P	P
29.	2201BM10216	VIJAY J	P	P	P	P	P
30.	2201BM10217	VENGATESHR	P	P	P	P	P
31.	2201BM10218	SHALINI S	P	P	P	P	P



PONNAIYAH RAMAJAYAM INSTITUTE OF SCIENCE & TECHNOLOGY (PRIST)

Declared as DEEMED TO BE UNIVERSITY
 U.S. 3 of 1956 Act, 1956

32.	2201BM10219	NIVYA A	P	P	P	P	P	P	P
33.	2201BM10220	MOHAMED ARSHATH ALIJ	P	P	P	P	P	P	P
34.	2201BM10221	MOHAMED AALITH M	P	P	P	P	P	P	P
35.	2201BM10222	VINOTHAR	P	P	P	P	P	P	P
36.	2201BM10223	ABIRAMILG	P	P	P	P	P	P	P
37.	2201BM10224	SANTHOSH R	P	P	P	P	P	P	P
38.	2201BM10225	YUVARAJ M	P	P	P	P	P	P	P
39.	2201BM10226	MANOJKUMAR S	P	P	P	P	P	P	P
40.	2201BM10227	NANDHAKUMAR M	P	P	P	P	P	P	P
41.	2201BM10228	VINOTHINI .P	P	P	P	P	P	P	P
42.	2201BM10229	RAMNATH K	P	P	P	P	P	P	P
43.	2201BM10230	ARUNA .K	P	P	P	P	P	P	P
44.	2201BM10231	MARIYAMMAL.R	P	P	P	P	P	P	P
45.	2201BM10232	PARVIN RAJ.S	P	P	P	P	P	P	P
46.	2201BM10233	SIVARANJANI. D	P	P	P	P	P	P	P
47.	2201BM10234	MOHAMED MASEEHUDEEN M.K	P	P	P	P	P	P	P
48.	2201BM10235	KARUNAKARAN S	P	P	P	P	P	P	P

[Handwritten signatures and initials]
 DEAN
 School of Commerce and Management
 Ponnaiyah Ramajayam Institute of
 Science & Technology (PRIST)
 THANJAVUR - 613 403.

[Handwritten signature]
 HOB
 Department of Business Management
 Ponnaiyah Ramajayam Institute of
 Science & Technology (PRIST)
 THANJAVUR - 613 403.



**PONNAIYAH RAMAJAYAM INSTITUTE OF
SCIENCE & TECHNOLOGY (PRIST)**

Declared as Deemed to be University
By U.O. No. 100 Act, 1956

2023-2024

**STUDENTS ATTENDANCE
DIPLOMA IN TAX PROCEDURE & PRACTICES**

S.NO	REG.NO	NAME	20/07/2023	21/07/2023	24/07/2023	25/07/2023	26/07/2023	27/07/2023	28/07/2023	31/07/2023
1.	2201BM10236	RAMYA G	P	P	P	P	P	P	P	P
2.	2201BM10237	SHAKTHI.P	P	P	P	P	P	P	P	P
3.	2201BM10238	SRIVARSHAN V	P	P	P	P	P	P	P	P
4.	2201BM10239	KASTURI H	P	P	P	P	P	P	P	P
5.	2201BM10240	UDHAYAVAN R	P	P	P	P	P	P	P	P
6.	2201BM10241	KRISHNAKUMAR.S	P	P	P	P	P	P	P	P
7.	2201BM10242	UDHAYA.T	P	P	P	P	P	P	P	P
8.	2201BM10243	VINOTH.P	P	P	P	P	P	P	P	P
9.	2201BM10244	KARAN.L	P	P	P	P	P	P	P	P
10	2201BM10245	SIVASARAN.P	P	P	P	P	P	P	P	P
11	2201BM10246	BHUVANESHJ	P	P	P	P	P	P	P	P
12	2201BM10247	ANTONY.S	P	P	P	P	P	P	P	P
13	2201BM20101	SADHAK ABDHULLAH	P	A	P	P	P	P	P	P
14	2201BM20102	GOKUL VASANTH	P	P	P	P	P	P	P	P
15	2201BM20103	SANJAI.S	P	P	P	P	P	A	P	P
16	2201BM20104	HARISH KUMAR .S	P	P	P	P	P	P	P	P
17	2201BM20105	SANTHOSH KUMAR. V	P	P	P	P	P	P	P	P
18	2201BM20106	AKESH. T	P	P	P	P	P	P	P	P
19	2201BM20107	BALAJI.S	P	P	P	P	P	P	P	P
20	2201BM20108	BHARANIKUMAR J	P	P	P	P	P	P	P	P
21	2201BM20109	HARIHARAN. S	P	P	P	P	P	P	P	P
22	2201BM20110	RIYAZ AHAMED. A	P	P	P	P	P	P	P	P
23	2201BM20111	DINESH .S	P	P	P	P	P	P	P	P
24	2201BM20112	HARI GOPI KRISHNA. R	P	P	P	P	P	P	P	P
25	2201BM20113	ABRAHAM. A	P	P	P	P	P	P	P	P
26	2201BM20114	VISHVA.N	P	P	P	P	P	P	P	P
27	2201BM20115	BALAJI.S	P	P	P	P	P	P	P	P
28	2201BM20116	GOWTHAM .P	P	P	P	P	P	P	P	P
29	2201BM20117	VIKRAM. K	P	P	P	P	P	P	P	P
30	2201BM20118	MOHAMED ASHIK. M	P	P	P	P	P	P	P	P
31	2201BM20119	KISHORE .R	P	P	P	P	P	P	P	P
32	2201BM20120	ABIMANYU .R	P	P	P	P	P	P	P	P
33	2201BM20121	SINGARAVEL. D	P	P	P	P	P	P	P	P
34	2201BM20122	DHAMOTHARAN. S	P	P	P	P	P	P	P	P
35	2201BM20123	SIVARANJITH BHARATHI. R	P	P	P	P	P	P	P	P
36	2201BM20124	THRUMENIRAJAN .R	P	P	P	P	P	P	P	P



PONNAIYAH RAMAJAYAM INSTITUTE OF SCIENCE & TECHNOLOGY (PRIST)

DECLARED AS DEEMED TO BE UNIVERSITY
U/S 3 of UGC Act, 1956

37	2201BM20125	MANIKANDAN .S	P	P	P	P	P	P	P	P	P	P	P	P	P	P
38	2201BM20126	RAMACHANDRAN .V	P	P	P	P	P	P	P	P	P	P	P	P	P	P
39	2201BM20127	RAJ MOHAN .P	P	P	P	P	P	P	P	P	P	P	P	P	P	P
40	2201BM20128	MANOJKUMAR .K	P	P	P	P	P	P	P	P	P	P	P	P	P	P
41	2201BM20129	VIKRAM .R	P	P	P	P	P	P	P	P	P	P	P	P	P	P
42	2201BM20130	ADHISVARAN .S	P	P	P	P	P	P	P	P	P	P	P	P	P	P

[Handwritten signatures and initials across the table rows]

[Handwritten signature]
 Department of Business Management
 Ponnaiyah Ramajayam Institute of
 Science & Technology (PRIST)
 THANJAVUR - 613 403.

[Handwritten signature]
 DEAN
 School of Commerce and Management
 Ponnaiyah Ramajayam Institute of
 Science & Technology (PRIST)
 THANJAVUR - 613 403.



**PONNAIYAH RAMAJAYAM INSTITUTE OF
SCIENCE & TECHNOLOGY (PRIST)**

DECLARED AS DEEMED TO BE UNIVERSITY
U/S 3 of UGC Act, 1956

S.NO	REG.NO	NAME	02/08/2023	03/08/2023	04/08/2023	08/08/2023	09/08/2023	10/08/2023	14/08/2023	18/08/2023
1.	2201BM10236	RAMYA G	P	P	P	P	P	P	P	P
2.	2201BM10237	SHAKTHI.P	P	P	P	P	P	P	P	P
3.	2201BM10238	SRIVARSHAN V	P	P	P	P	P	P	P	P
4.	2201BM10239	KASTURI H	P	P	P	P	P	P	P	P
5.	2201BM10240	UDHAYAVAN R	P	P	P	P	P	P	P	P
6.	2201BM10241	KRISHNAKUMAR.S	P	P	P	P	P	P	P	P
7.	2201BM10242	UDHAYA.T	P	P	P	P	P	P	P	P
8.	2201BM10243	VINOTH.P	P	P	P	P	P	P	P	P
9.	2201BM10244	KARAN.L	P	P	P	P	P	P	P	P
10.	2201BM10245	SIVASARAN.P	P	P	P	P	P	P	P	P
11.	2201BM10246	BHUVANESHJ	P	P	P	P	P	P	P	P
12.	2201BM10247	ANTONY.S	P	P	P	P	P	P	P	P
13.	2201BM20101	SADHAK ABDHULLAH	P	A	P	P	P	P	P	P
14.	2201BM20102	GOKUL VASANTH	P	P	P	P	P	P	P	P
15.	2201BM20103	SANJAL. S	P	P	P	P	P	A	P	P
16.	2201BM20104	HARISH KUMAR. S	P	P	P	P	P	P	P	P
17.	2201BM20105	SANTHOSH KUMAR. V	P	P	P	P	P	P	P	P
18.	2201BM20106	AKESH. T	P	P	P	P	P	P	P	P
19.	2201BM20107	BALAJI. S	P	P	P	P	P	P	P	P
20.	2201BM20108	BHARANIKUMAR. J	P	P	P	P	P	P	P	P
21.	2201BM20109	HARHARAN. S	P	P	P	P	P	P	P	P
22.	2201BM20110	RIYAZ AHAMED. A	P	P	P	P	P	P	P	P
23.	2201BM20111	DINESH. S	P	P	P	P	P	P	P	P
24.	2201BM20112	HARI GOPI KRISHNA. R.	P	P	P	P	P	P	P	P
25.	2201BM20113	ABRAHAM. A	P	P	P	P	P	P	P	P
26.	2201BM20114	VISHVA. N	P	P	P	P	P	P	P	P
27.	2201BM20115	BALAJI. S	P	P	P	P	P	P	P	P
28.	2201BM20116	GOWTHAM. P	P	P	P	P	P	P	P	P
29.	2201BM20117	VIKRAM. K	P	P	P	P	P	P	P	P
30.	2201BM20118	MOHAMED ASHIK. M	P	P	P	P	P	P	P	P
31.	2201BM20119	KISHORE. R	P	P	P	P	P	P	P	P
32.	2201BM20120	ABIMANYU. R	P	P	P	P	P	P	P	P
33.	2201BM20121	SINGARAVEL. D	P	P	P	P	P	P	P	P
34.	2201BM20122	DHAMOTHARAN. S	P	P	P	P	P	P	P	P
35.	2201BM20123	SIVARANJITH BHARATHI. R	P	P	P	P	P	P	P	P
36.	2201BM20124	THIRUMENIRAJAN. R	P	P	P	P	P	P	P	P
37.	2201BM20125	MANIKANDAN. S	P	P	P	P	P	P	P	P



PONNAIYAH RAMAJAYAM INSTITUTE OF SCIENCE & TECHNOLOGY (PRIST)

Decreed as OFI MED. TO BE UNIVERSITY
 U.S. 3 of UGC Act, 1956

38	2201BM20126	RAMACHANDRAN.V	P	P	P	P	P	P	P	P	P	P	P	P	P	P	P
39	2201BM20127	RAJ MOHAN.P	P	P	P	P	P	P	P	P	P	P	P	P	P	P	P
40	2201BM20128	MANOIKUMAR.K	P	P	P	P	P	P	P	P	P	P	P	P	P	P	P
41	2201BM20129	VIKRAM.R	P	P	P	P	P	P	P	P	P	P	P	P	P	P	P
42	2201BM20130	ADHISVARAN.S	P	P	P	P	P	P	P	P	P	P	P	P	P	P	P

[Handwritten signatures and initials across the table rows]

[Signature]
 HOD
 Department of Business Management
 Ponnaiyah Ramajayam Institute of
 Science & Technology (PRIST)
 THANJAVUR-613 403.

[Signature]
 DEAN
 School of Commerce and Management
 Ponnaiyah Ramajayam Institute of
 Science & Technology (PRIST)
 THANJAVUR-613 403.



**PONNAIYAH RAMAJAYAM INSTITUTE OF
SCIENCE & TECHNOLOGY (PRIST)**

DECLARED AS DEEMED-TO-BE UNIVERSITY
U/S 3 OF UGC ACT, 1956

S.NO	REG.NO	NAME	21/08/2023	22/08/2023	04/09/2023	05/09/2023	06/09/2023	08/09/2023	12/09/2023	14/09/2023
1.	2201BM10236	RAMYA G	P	P	P	P	P	P	P	P
2.	2201BM10237	SHAKTHI.P	P	P	P	P	P	P	P	P
3.	2201BM10238	SRIVARSHAN.V	P	P	P	P	P	P	P	P
4.	2201BM10239	KASTURI.H	P	P	P	P	P	P	P	P
5.	2201BM10240	UDHAYAVAN.R	P	P	P	P	P	P	P	P
6.	2201BM10241	KRISHNAKUMAR.S	P	P	P	P	P	P	P	P
7.	2201BM10242	UDHAYA.T	P	P	P	P	P	P	P	P
8.	2201BM10243	VINOTH.P	P	P	P	P	P	P	P	P
9.	2201BM10244	KARAN.L	P	P	P	P	P	P	P	P
10.	2201BM10245	SIVASARAN.P	P	P	P	P	P	P	P	P
11.	2201BM10246	BHUVANESH.J	P	P	P	P	P	P	P	P
12.	2201BM10247	ANTONY.S	P	P	P	P	P	P	P	P
13.	2201BM20101	SADHAK ABDHULLAH	P	A	P	P	P	P	P	P
14.	2201BM20102	GOKUL VASANTH	P	P	P	P	P	P	P	P
15.	2201BM20103	SANJAI.S	P	P	P	P	P	A	P	P
16.	2201BM20104	HARISH KUMAR .S	P	P	P	P	P	P	P	P
17.	2201BM20105	SANTHOSH KUMAR. V	P	P	P	P	P	P	P	P
18.	2201BM20106	AKESH. T	P	P	P	P	P	P	P	P
19.	2201BM20107	BALAJI. S	P	P	P	P	P	P	P	P
20.	2201BM20108	BHARANIKUMAR. J	P	P	P	P	P	P	P	P
21.	2201BM20109	HARIHARAN. S	P	P	P	P	P	P	P	P
22.	2201BM20110	RIYAZ AHAMED. A	P	P	P	P	P	P	P	P
23.	2201BM20111	DINESH. S	P	P	P	P	P	P	P	P
24.	2201BM20112	HARI GOPI KRISHNA. R	P	P	P	P	P	P	P	P
25.	2201BM20113	ABRAHAM. A	P	P	P	P	P	P	P	P
26.	2201BM20114	VISHVA. N	P	P	P	P	P	P	P	P
27.	2201BM20115	BALAJI. S	P	P	P	P	P	P	P	P
28.	2201BM20116	GOWTHAM. P	P	P	P	P	P	P	P	P
29.	2201BM20117	VIKRAM. K	P	P	P	P	P	P	P	P
30.	2201BM20118	MOHAMED ASHIK. M	P	P	P	P	P	P	P	P
31.	2201BM20119	KISHORE. R	P	P	P	P	P	P	P	P
32.	2201BM20120	ABIMANYU. R	P	P	P	P	P	P	P	P
33.	2201BM20121	SINGARAVEL. D	P	P	P	P	P	P	P	P
34.	2201BM20122	DHAMOTHARAN. S	P	P	P	P	P	P	P	P
35.		SIVARANJITH	P	P	P	P	P	P	P	P
	2201BM20123	BHARATHI. R								
36.	2201BM20124	THIRUMENIRAJAN. R	P	P	P	P	P	P	P	P
37.	2201BM20125	MANIKANDAN. S	P	P	P	P	P	P	P	P



PONNAIYAH RAMAJAYAM INSTITUTE OF SCIENCE & TECHNOLOGY (PRIST)

Declared as DEEMED TO BE UNIVERSITY
 UIR 3 of UGC Act, 1956

38.	2201BM20126	RAMACHANDRAN .V	P	P	P	P	P	P	P	P	P	P	P	P	P	P	P
39.	2201BM20127	RAJ MOHAN .P	P	P	P	P	P	P	P	P	P	P	P	P	P	P	P
40.	2201BM20128	MANOJKUMAR. K	P	P	P	P	P	P	P	P	P	P	P	P	P	P	P
41.	2201BM20129	VIKRAM.R	P	P	P	P	P	P	P	P	P	P	P	P	P	P	P
42.	2201BM20130	ADHISVARAN .S	P	P	P	P	P	P	P	P	P	P	P	P	P	P	P

[Handwritten signatures and initials in the right margin of the table]

[Signature]
HOD-
 Department of Business Management,
 Ponnaiyah Ramajayam Institute of
 Science & Technology (PRIST)
 THANJAVUR - 610 403.

[Signature]
DEAN
 School of Commerce and Management,
 Ponnaiyah Ramajayam Institute of
 Science & Technology (PRIST)
 THANJAVUR - 610 403.



**PONNAIYAH RAMAJAYAM INSTITUTE OF
SCIENCE & TECHNOLOGY (PRIST)**

DECLINED AS DECMEED TO BE UNIVERSITY
UFG 3 OF UGC ACT, 1956

S.NO	REG.NO	NAME	18/09/2023	20/09/2023	21/09/2023	25/09/2023	27/09/2023	05/10/2023	10/10/2023	11/10/2023
1.	2201BM10236	RAMYA G	P	P	P	P	P	P	P	P
2.	2201BM10237	SHAKTHI .P	P	P	P	P	P	P	P	P
3.	2201BM10238	SRIVARSHAN V	P	P	P	P	P	P	P	P
4.	2201BM10239	KASTURI H	P	P	P	P	P	P	P	P
5.	2201BM10240	UDHAYAVAN R	P	P	P	P	P	P	P	P
6.	2201BM10241	KRISHNAKUMAR.S	P	P	P	P	P	P	P	P
7.	2201BM10242	UDHAYA.T	P	P	P	P	P	P	P	P
8.	2201BM10243	VINOOTH.P	P	P	P	P	P	P	P	P
9.	2201BM10244	KARAN.L	P	P	P	P	P	P	P	P
10.	2201BM10245	SIVASARAN.P	P	P	P	P	P	P	P	P
11.	2201BM10246	BHUVANESHJ	P	P	P	P	P	P	P	P
12.	2201BM10247	ANTONY.S	P	P	P	P	P	P	P	P
13.	2201BM20101	SADHAK ABDHULLAH	P	A	P	P	P	P	P	P
14.	2201BM20102	GOKUL VASANTH	P	P	P	P	P	P	P	P
15.	2201BM20103	SANJAL.S	P	P	P	P	P	A	P	P
16.	2201BM20104	HARISH KUMAR .S	P	P	P	P	P	P	P	P
17.	2201BM20105	SANTHOSH KUMAR. V	P	P	P	P	P	P	P	P
18.	2201BM20106	AKESH. T	P	P	P	P	P	P	P	P
19.	2201BM20107	BALAJI. S	P	P	P	P	P	P	P	P
20.	2201BM20108	BHARANIKUMAR.J	P	P	P	P	P	P	P	P
21.	2201BM20109	HARIHARAN. S	P	P	P	P	P	P	P	P
22.	2201BM20110	RIYAZ AHAMED. A	P	P	P	P	P	P	P	P
23.	2201BM20111	DINESH .S	P	P	P	P	P	P	P	P
24.	2201BM20112	HARI GOPI KRISHNA. R	P	P	P	P	P	P	P	P
25.	2201BM20113	ABRAHAM. A	P	P	P	P	P	P	P	P
26.	2201BM20114	VISHVA .N	P	P	P	P	P	P	P	P
27.	2201BM20115	BALAJI.S	P	P	P	P	P	P	P	P
28.	2201BM20116	GOWTHAM .P	P	P	P	P	P	P	P	P
29.	2201BM20117	VIKRAM. K	P	P	P	P	P	P	P	P
30.	2201BM20118	MOHAMED ASHIK. M	P	P	P	P	P	P	P	P
31.	2201BM20119	KISHORE .R	P	P	P	P	P	P	P	P
32.	2201BM20120	ABIMANYU .R	P	P	P	P	P	P	P	P
33.	2201BM20121	SINGARAVEL. D	P	P	P	P	P	P	P	P
34.	2201BM20122	DHAMOTHARAN. S	P	P	P	P	P	P	P	P



PONNAIYAH RAMAJAYAM INSTITUTE OF SCIENCE & TECHNOLOGY (PRIST)

Declared as DEEMED TO BE UNIVERSITY
 Uts 3 of UGC Act, 1956

35.	2201BM20123	SIVARANJITHI BHARATHI. R	P	P	P	P	P	P	P	P	P	P
36.	2201BM20124	THIRUMENIRAJAN .R	P	P	P	P	P	P	P	P	P	P
37.	2201BM20125	MANIKANDAN .S	P	P	P	P	P	P	P	P	P	P
38.	2201BM20126	RAMACHANDRAN .V	P	P	P	P	P	P	P	P	P	P
39.	2201BM20127	RAJ MOHAN .P	P	P	P	P	P	P	P	P	P	P
40.	2201BM20128	MANOJKUMAR. K	P	P	P	P	P	P	P	P	P	P
41.	2201BM20129	VIKRAM. R	P	P	P	P	P	P	P	P	P	P
42.	2201BM20130	ADHISVARAN .S	P	P	P	P	P	P	P	P	P	P

[Handwritten signatures and initials across the table rows]

[Handwritten signature]
 WOD
 Department of Business Management
 Ponnaiyah Ramajayam Institute of
 Science & Technology (PRIST)
 THANJAVUR-613 403.

[Handwritten signature]
 DEAN
 School of Commerce and Management
 Ponnaiyah Ramajayam Institute of
 Science & Technology (PRIST)
 THANJAVUR-613 403.



**PONNAIYAH RAMAJAYAM INSTITUTE OF
SCIENCE & TECHNOLOGY (PRIST)**

Declared as Deemed-to-Be University
U.S. 3 of UGC Act, 1956

S.NO	REG.NO	NAME	12/10/2023	16/10/2023	17/10/2023	18/10/2023	19/10/2023	20/10/2023	06/11/2023	07/11/2023
1.	2201BM10236	RAMYA G	P	P	P	P	P	P	P	P
2.	2201BM10237	SHAKITHI.P	P	P	P	P	P	P	P	P
3.	2201BM10238	SRIVARSHAN V	P	P	P	P	P	P	P	P
4.	2201BM10239	KASTURI H	P	P	P	P	P	P	P	P
5.	2201BM10240	UDHAYAVAN R	P	P	P	P	P	P	P	P
6.	2201BM10241	KRISHNAKUMAR.S	P	P	P	P	P	P	P	P
7.	2201BM10242	UDHAYA.T	P	P	P	P	P	P	P	P
8.	2201BM10243	VINOOTH.P	P	P	P	P	P	P	P	P
9.	2201BM10244	KARAN.L	P	P	P	P	P	P	P	P
10.	2201BM10245	SIVASARAN.P	P	P	P	P	P	P	P	P
11.	2201BM10246	BHUVANESHJ	P	P	P	P	P	P	P	P
12.	2201BM10247	ANTONY.S	P	P	P	P	P	P	P	P
13.		SADHAK	P	A	P	P	P	P	P	P
	2201BM20101	ABDHULLAH								
14.	2201BM20102	GOKUL VASANTH	P	P	P	P	P	P	P	P
15.	2201BM20103	SANJAI.S	P	P	P	P	P	A	P	P
16.	2201BM20104	HARISH KUMAR.S	P	P	P	P	P	P	P	P
17.		SANTHOSH KUMAR. V	P	P	P	P	P	P	P	P
18.	2201BM20106	AKESH. T	P	P	P	P	P	P	P	P
19.	2201BM20107	BALAJI.S	P	P	P	P	P	P	P	P
20.	2201BM20108	BHARANIKUMAR.J	P	P	P	P	P	P	P	P
21.	2201BM20109	HARIHARAN.S	P	P	P	P	P	P	P	P
22.	2201BM20110	RIYAZ AHAMED.A	P	P	P	P	P	P	P	P
23.	2201BM20111	DINESH.S	P	P	P	P	P	P	P	P
24.		HARI GOPI KRISHNA. R	P	P	P	P	P	P	P	P
25.	2201BM20113	ABRAHAM.A	P	P	P	P	P	P	P	P
26.	2201BM20114	VISHVA.N	P	P	P	P	P	P	P	P
27.	2201BM20115	BALAJI.S	P	P	P	P	P	P	P	P
28.	2201BM20116	GOWTHAM.P	P	P	P	P	P	P	P	P
29.	2201BM20117	VIKRAM.K	P	P	P	P	P	P	P	P
30.	2201BM20118	MOHAMED ASHIK.M	P	P	P	P	P	P	P	P
31.	2201BM20119	KISHORE.R	P	P	P	P	P	P	P	P
32.	2201BM20120	ABIMANYU.R	P	P	P	P	P	P	P	P
33.	2201BM20121	SINGARAVEL.D	P	P	P	P	P	P	P	P
34.	2201BM20122	DHAMOTHARAN.S	P	P	P	P	P	P	P	P
35.		SIVARANJITH	P	P	P	P	P	P	P	P
	2201BM20123	BHARATHI.R								
36.	2201BM20124	THIRUMENIRAJAN.R	P	P	P	P	P	P	P	P



PONNAIYAH RAMAJAYAM INSTITUTE OF SCIENCE & TECHNOLOGY (PRIST)

Declared as DEEMED-TO-BE-UNIVERSITY
U.S. 3 of HGG Act, 1956

37.	2201BM20125	MANIKANDAN .S	P	P	P	P	P	P	P	P	P	P	P	P	P
38.	2201BM20126	RAMACHANDRAN .V	P	P	P	P	P	P	P	P	P	P	P	P	P
39.	2201BM20127	RAJ MOHAN .P	P	P	P	P	P	P	P	P	P	P	P	P	P
40.	2201BM20128	MANOJKUMAR. K	P	P	P	P	P	P	P	P	P	P	P	P	P
41.	2201BM20129	VIKRAM. R	P	P	P	P	P	P	P	P	P	P	P	P	P
42.	2201BM20130	ADHISVARAN .S	P	P	P	P	P	P	P	P	P	P	P	P	P

Handwritten signatures and initials in the right margin of the table, including 'S. S.', 'S. S.', 'S. S.', 'S. S.', 'S. S.', and 'S. S.'.

HOD
Department of Business Management
Ponnaiyah Ramajayam Institute of
Science & Technology (PRIST)
THANJAVUR - 613 404

DEAN
School of Commerce and Management
Ponnaiyah Ramajayam
Science & Technology (PRIST)
THANJAVUR - 613 463.



**PONNAIYAH RAMAJAYAM INSTITUTE OF
SCIENCE & TECHNOLOGY (PRIST)**

Incorporated as DEEMED-TO-BE UNIVERSITY
U.S. 3 of UGC ACT, 1956

S.NO	REG.NO	NAME	12/12/2023	13/12/2023	14/12/2023	15/12/2023	18/12/2023
1.	2201BM10236	RAMYA.G	P	P	P	P	P
2.	2201BM10237	SHAKTHI.P	P	P	P	P	P
3.	2201BM10238	SRIVARSHAN.V	P	P	P	P	P
4.	2201BM10239	KASTURI.H	P	P	P	P	P
5.	2201BM10240	UDHAYAVAN.R	P	P	P	P	P
6.	2201BM10241	KRISHNAKUMAR.S	P	P	P	P	P
7.	2201BM10242	UDHAYA.T	P	P	P	P	P
8.	2201BM10243	VINOTH.P	P	P	P	P	P
9.	2201BM10244	KARAN.L	P	P	P	P	P
10.	2201BM10245	SIVASARAN.P	P	P	P	P	P
11.	2201BM10246	BHUVANESH.H	P	P	P	P	P
12.	2201BM10247	ANTONY.S	P	P	P	P	P
13.	2201BM20101	SADHAK ABDHULLAH	P	A	P	P	P
14.	2201BM20102	GOKUL.VASANTH	P	P	P	P	P
15.	2201BM20103	SANJAL.S	P	P	P	P	P
16.	2201BM20104	HARISH.KUMAR.S	P	P	P	P	P
17.	2201BM20105	SANTHOSH.KUMAR. V	P	P	P	P	P
18.	2201BM20106	AKESH.T	P	P	P	P	P
19.	2201BM20107	BALAJI.S	P	P	P	P	P
20.	2201BM20108	BHARANIKUMAR.J	P	P	P	P	P
21.	2201BM20109	HARIHARAN.S	P	P	P	P	P
22.	2201BM20110	RIYAZ.AHMED.A	P	P	P	P	P
23.	2201BM20111	DINESH.S	P	P	P	P	P
24.	2201BM20112	HARI GOPI KRISHNA. R	P	P	P	P	P
25.	2201BM20113	ABRAHAM.A	P	P	P	P	P
26.	2201BM20114	VISHVA.N	P	P	P	P	P
27.	2201BM20115	BALAJI.S	P	P	P	P	P
28.	2201BM20116	GOWTHAM.P	P	P	P	P	P
29.	2201BM20117	VIKRAM.K	P	P	P	P	P
30.	2201BM20118	MOHAMED ASHIK.M	P	P	P	P	P



PONNAIYAH RAMAJAYAM INSTITUTE OF SCIENCE & TECHNOLOGY (PRIST)

Deemed as DEEMED-TO-BE UNIVERSITY
U/S 3 of UGC Act, 1956

31.	2201BM20119	KISHORE .R	P	P	P	P	P	P
32.	2201BM20120	ABIMANYU .R	P	P	P	P	P	P
33.	2201BM20121	SINGARAVEL .D	P	P	P	P	P	P
34.	2201BM20122	DHAMOTHARAN .S	P	P	P	P	P	P
35.	2201BM20123	SIVARANJITH BHARATHI .R	P	P	P	P	P	P
36.	2201BM20124	THIRUMENIRAJAN .R	P	P	P	P	P	P
37.	2201BM20125	MANIKANDAN .S	P	P	P	P	P	P
38.	2201BM20126	RAMACHANDRAN .V	P	P	P	P	P	P
39.	2201BM20127	RAJ MOHAN .P	P	P	P	P	P	P
40.	2201BM20128	MANOIKUMAR .K	P	P	P	P	P	P
41.	2201BM20129	VIKRAM .R	P	P	P	P	P	P
42.	2201BM20130	ADHISVARAN .S	P	P	P	P	P	P

[Handwritten signatures and initials in the right margin of the table]

[Handwritten signature]

Department of Business Management
Ponnaiyah Ramajayam Institute of
Science & Technology (PRIST)
THANJAVUR - 613 403.

[Handwritten signature]
DEAN

School of Commerce and Management
Ponnaiyah Ramajayam Institute of
Science & Technology (PRIST)
THANJAVUR - 613 403.



**PONNAIYAH RAMAJAYAM INSTITUTE OF
SCIENCE & TECHNOLOGY (PRIST)**

Declassified as DECEMED TO BE UNIVERSITY
U.S. 3 of 1990 Act, 1956

ODD SEMESTER

CERTIFICATE COURSE IN SALES AND MARKETING

S.NO	REG.NO	NAME	17/07/2023	18/07/2023	19/07/2023	20/07/2023	21/07/2023	25/07/2023	26/07/2023	28/07/2023
1.	2201BM20131	SAKTHIVEL.V	P	P	P	P	P	P	P	P
2.	2201BM20132	RAJESH.R	P	P	P	P	P	P	P	P
3.	2201BM20133	MANIKANDAN.G	P	P	P	P	P	P	P	P
4.	2201BM20134	SRIRAM PRAKASH.S	P	P	P	P	P	P	P	P
5.	2201BM20135	SADAM HUSSAIN.S	P	P	P	P	P	P	P	P
6.	2201BM20136	RABIN BACKIYA.J	P	P	P	P	P	P	P	P
7.	2201BM20137	ESHWARAN.K	P	P	P	P	P	P	P	P
8.	2201BM20138	BHARANI.V	P	P	P	P	P	P	P	P
9.	2201BM20139	KEERTHI AAKASH.P	P	P	P	P	P	P	P	P
10.	2201BM20140	SRIRAM.M	P	P	P	P	P	P	P	P
11.	2201BM20141	SARAVANAN.K	P	P	P	P	P	P	P	P
12.	2201BM20142	KARTHICKRAJA.R	P	P	P	P	P	P	P	P
13.	2201BM20143	SIVAPRIYAN.E	P	A	P	P	P	P	P	P
14.	2201BM20144	RAVICHANDRAN.A	P	P	P	P	P	P	P	P
15.	2201BM20145	SIVAPRAKASAM.S	P	P	P	P	P	A	P	P
16.	2201BM20146	THARMADURAI.T	P	P	P	P	P	P	P	P
17.	2201BM20201	SWATHIKA.M	P	P	P	P	P	P	P	P
18.	2201BM20202	MALARVIZHI.R	P	P	P	P	P	P	P	P
19.	2201BM20203	ELAKKIYA.M	P	P	P	P	P	P	P	P
20.	2201BM20204	KEERTHIKA.S	P	P	P	P	P	P	P	P
21.	2201BM20205	NEEVI SRI.T	P	P	P	P	P	P	P	P
22.	2201BM20207	VAISHNAVI.S	P	P	P	P	P	P	P	P
23.	2201BM20208	PRIYADHARSHINI.S	P	P	P	P	P	P	P	P
24.	2201BM20209	RAMYA.R	P	P	P	P	P	P	P	P
25.	2201BM20210	PAVITHRA.M	P	P	P	P	P	P	P	P
26.	2201BM20211	SHAKTHI.P	P	P	P	P	P	P	P	P
27.	2201BM20212	ANITHA.S	P	P	P	P	P	P	P	P
28.	2201BM20213	ARTHI.R	P	P	P	P	P	P	P	P
29.	2201BM20214	JOTHIKA.S	P	P	P	P	P	P	P	P
30.	2201BM20215	ABINAYA.A	P	P	P	P	P	P	P	P
31.	2101BM10101	SRIRAMAN.S	P	P	P	P	P	P	P	P
32.	2101BM10102	PRAVEENRAJ.V	P	P	P	P	P	P	P	P
33.	2101BM10103	SUNDARRAJAN.T	P	P	P	P	P	P	P	P
34.	2101BM10103	GOKULAPRIYAN.R	P	P	P	P	P	P	P	P
35.	2101BM10104	RAJASURYA.B	P	P	P	P	P	P	P	P



PONNAIYAH RAMAJAYAM INSTITUTE OF SCIENCE & TECHNOLOGY (PRIST)

Declared as BEEMED TO BE UNIVERSITY
 (U.S. 3 of 1956 Act, 1956)

36.	2101BM10105	DHANDAYUTHABANI V	P	P	P	P	P	P	P	P	P	P	P
37.	2101BM10106	SANTHOSH. R	P	P	P	P	P	P	P	P	P	P	P
38.	2101BM10107	VAJRA S	P	P	P	P	P	P	P	P	P	P	P
39.	2101BM10107	MOHAMED FASHITH. B	P	P	P	P	P	P	P	P	P	P	P
40.	2101BM10108	SELVARAJ. U	P	P	P	P	P	P	P	P	P	P	P
41.	2101BM10109	ARULJAGAN. J	P	P	P	P	P	P	P	P	P	P	P
42.	2101BM10110	MATHAVAN. S	P	P	P	P	P	P	P	P	P	P	P

[Handwritten signatures and initials across the table rows]

[Handwritten signature]

Department of Business Management
 Ponnaiyah Ramajayam Institute of
 Science & Technology (PRIST)
 THANJAVUR - 613 403.

[Handwritten signature]
 DEAN

School of Commerce and Management
 Ponnaiyah Ramajayam Institute of
 Science & Technology (PRIST)
 THANJAVUR - 613 403.



**PONNAIYAH RAMAJAYAM INSTITUTE OF
SCIENCE & TECHNOLOGY (PRIST)**

Declared as DEEMED-TO-BE UNIVERSITY
U.P. No. 1000, A.C. 1956

S.NO	REG.NO	NAME	31/07/2023	01/08/2023	03/08/2023	04/08/2023	08/08/2023	09/08/2023	10/08/2023	14/08/2023
1.	2201BM20131	SAKTHIVEL.V	P	P	P	P	P	P	P	P
2.	2201BM20132	RAJESH.R	P	P	P	P	P	P	P	P
3.	2201BM20133	MANIKANDAN.G	P	P	P	P	P	P	P	P
4.	2201BM20134	SRIRAM PRAKASH.S	P	P	P	P	P	P	P	P
5.	2201BM20135	SADAM HUSSAIN.S	P	P	P	P	P	P	P	P
6.	2201BM20136	RABIN BACKIYA.J	P	P	P	P	P	P	P	P
7.	2201BM20137	ESHWARAN.K	P	P	P	P	P	P	P	P
8.	2201BM20138	BHARANI.V	P	P	P	P	P	P	P	P
9.	2201BM20139	KEERTHI AAKASH.P	P	P	P	P	P	P	P	P
10.	2201BM20140	SRIRAM.M	P	P	P	P	P	P	P	P
11.	2201BM20141	SARAVANAN.K	P	P	P	P	P	P	P	P
12.	2201BM20142	KARTHICKRAJA.R	P	P	P	P	P	P	P	P
13.	2201BM20143	SIVAPRIYAN.E	P	P	P	P	P	P	P	P
14.	2201BM20144	RAVICHANDRAN.A	P	P	P	P	P	P	P	P
15.	2201BM20145	SIVAPRAKASAM.S	P	P	P	P	P	P	P	P
16.	2201BM20146	THARMADURAI.T	P	P	P	P	P	P	P	P
17.	2201BM20201	SWATHIKA.M	P	P	P	P	P	P	P	P
18.	2201BM20202	MALARVIZHI.R	P	P	P	P	P	P	P	P
19.	2201BM20203	ELAKKIYA.M	P	P	P	P	P	P	P	P
20.	2201BM20204	KEERTHIKA.S	P	P	P	P	P	P	P	P
21.	2201BM20205	NEEVI SRI.T	P	P	P	P	P	P	P	P
22.	2201BM20207	VAISHNAVI.S	P	P	P	P	P	P	P	P
23.	2201BM20208	PRIYADHARSHINI.S	P	P	P	P	P	P	P	P
24.	2201BM20209	RAMYA.R	P	P	P	P	P	P	P	P
25.	2201BM20210	PAVITHRA.M	P	P	P	P	P	P	P	P
26.	2201BM20211	SHAKTHI.P	P	P	P	P	P	P	P	P
27.	2201BM20212	ANITHA.S	P	P	P	P	P	P	P	P
28.	2201BM20213	ARTHI.R	P	P	P	P	P	P	P	P
29.	2201BM20214	JOTHIKA.S	P	P	P	P	P	P	P	P
30.	2201BM20215	ABINAYA.A	P	P	P	P	P	P	P	P
31.	2101BM10101	SRIRAMAN.S	P	P	P	P	P	P	P	P
32.	2101BM10102	PRAVEENRAJ.V	P	P	P	P	P	P	P	P
33.	2101BM10103	SUNDARRAJAN.T	P	P	P	P	P	P	P	P
34.	2101BM10103	GOKULAPRIYAN.R	P	P	P	P	P	P	P	P
35.	2101BM10104	RAJASURYA.B	P	P	P	P	P	P	P	P
36.	2101BM10105	DHANDAYUTHABANI V	P	P	P	P	P	P	P	P
37.	2101BM10106	SANTHOSH.R	P	P	P	P	P	P	P	P



PONNAIYAH RAMAJAYAM INSTITUTE OF SCIENCE & TECHNOLOGY (PRIST)

Declared as DEEMED-TO BE UNIVERSITY
U.S. 3 of UGC Act, 1956

38.	2101BM10107	VAJRA S	P	P	P	P	P	P	P	P	P	P	P	P	P	P	P
39.	2101BM10107	MOHAMED FASHITH. B	P	P	P	P	P	P	P	P	P	P	P	P	P	P	P
40.	2101BM10108	SELVARAJ. U	P	P	P	P	P	P	P	P	P	P	P	P	P	P	P
41.	2101BM10109	ARUL JAGAN. J	P	P	P	P	P	P	P	P	P	P	P	P	P	P	P
42.	2101BM10110	MATHAVAN. S	P	P	P	P	P	P	P	P	P	P	P	P	P	P	P

[Handwritten signatures and initials across the table rows]

[Handwritten signature]
 HOD
 Department of Business Management
 Ponnaiyah Ramajayam Institute of
 Science & Technology (PRIST)
 THANJAVUR - 613 403.

[Handwritten signature]
 DEAN
 School of Commerce and Management
 Ponnaiyah Ramajayam Institute of
 Science & Technology (PRIST)
 THANJAVUR - 613 403.



**PONNAIYAH RAMAJAYAM INSTITUTE OF
SCIENCE & TECHNOLOGY (PRIST)**

Declared as Deemed-to BE University
Utr 3 of HCC Act, 1956

S.NO	REG.NO	NAME	16/08/2023	17/08/2023	18/08/2023	07/09/2023	08/09/2023	12/09/2023	13/09/2023
1.	2201BM20131	SAKTHIVEL.V	P	P	P	P	P	P	P
2.	2201BM20132	RAJESH.R	P	P	P	P	P	P	P
3.	2201BM20133	MANIKANDAN.G	P	P	P	P	P	P	P
4.	2201BM20134	SRIRAM PRAKASH.S	P	P	P	P	P	P	P
5.	2201BM20135	SADAM HUSSAIN.S	P	P	P	P	P	P	P
6.	2201BM20136	RABIN BACKIYA.J	P	P	P	P	P	P	P
7.	2201BM20137	ESHWARAN.K	P	P	P	P	P	P	P
8.	2201BM20138	BHARANI.V	P	P	P	P	P	P	P
9.	2201BM20139	KEERTHI AAKASH.P	P	P	P	P	P	P	P
10.	2201BM20140	SRIRAM.M	P	P	P	P	P	P	P
11.	2201BM20141	SARAVANAN.K	P	P	P	P	P	P	P
12.	2201BM20142	KARTHICKRAJA.R	P	P	P	P	P	P	P
13.	2201BM20143	SIVAPRIYAN.E	P	A	P	P	P	P	P
14.	2201BM20144	RAVICHANDRAN.A	P	P	P	P	P	P	P
15.	2201BM20145	SIVAPRAKASAM.S	P	P	P	P	P	A	P
16.	2201BM20146	THARMADURAI.T	P	P	P	P	P	P	P
17.	2201BM20201	SWATHIKA.M	P	P	P	P	P	P	P
18.	2201BM20202	MALARVIZHU.R	P	P	P	P	P	P	P
19.	2201BM20203	ELAKKIYA.M	P	P	P	P	P	P	P
20.	2201BM20204	KEERTHIKA.S	P	P	P	P	P	P	P
21.	2201BM20205	NEEVI SRI.T	P	P	P	P	P	P	P
22.	2201BM20207	VAISHNAVI.S	P	P	P	P	P	P	P
23.	2201BM20208	PRIYADHARSHINI.S	P	P	P	P	P	P	P
24.	2201BM20209	RAMYA.R	P	P	P	P	P	P	P
25.	2201BM20210	PAVITHRA.M	P	P	P	P	P	P	P
26.	2201BM20211	SHAKTHI.P	P	P	P	P	P	P	P
27.	2201BM20212	ANITHA.S	P	P	P	P	P	P	P
28.	2201BM20213	ARTHI.R	P	P	P	P	P	P	P
29.	2201BM20214	JOTHIKA.S	P	P	P	P	P	P	P
30.	2201BM20215	ABINAYA.A	P	P	P	P	P	P	P
31.	2101BM10101	SRIRAMAN.S	P	P	P	P	P	P	P
32.	2101BM10102	PRAVEENRAJ.V	P	P	P	P	P	P	P
33.	2101BM10103	SUNDARRAJAN.T	P	P	P	P	P	P	P
34.	2101BM10103	GOKULAPRIYAN.R	P	P	P	P	P	P	P
35.	2101BM10104	RAJASURYA.B	P	P	P	P	P	P	P
36.	2101BM10105	DHANDAYUTHABANI V	P	P	P	P	P	P	P
37.	2101BM10106	SANTHOSH.R	P	P	P	P	P	P	P



PONNAIYAH RAMAJAYAM INSTITUTE OF SCIENCE & TECHNOLOGY (PRIST)

DECLARED AS DEEMED TO BE UNIVERSITY
 U/S 3 of UGC Act, 1956

38.	2101BM10107	VAJRA S	P	P	P	P	P	P	P	P	P	P
39.	2101BM10107	MOHAMED FASHITH. B	P	P	P	P	P	P	P	P	P	P
40.	2101BM10108	SELVARAJ. U	P	P	P	P	P	P	P	P	P	P
41.	2101BM10109	ARUL JAGAN. J	P	P	P	P	P	P	P	P	P	P
42.	2101BM10110	MATHAVAN. S	P	P	P	P	P	P	P	P	P	P

Handwritten signatures and initials:
 P. S. S. (over 38, 39, 40)
 P. S. S. (over 41, 42)
 P. S. S. (over 42)
 P. S. S. (over 42)

Handwritten signature: P. S. S.
HOD
 Department of Business Management
 Ponnaiyah Ramajayam Institute of
 Science & Technology (PRIST)
 THANJAVUR - 613 403.

Handwritten signature: P. S. S.
 Lecturer
 School of Commerce and Management
 Ponnaiyah Ramajayam Institute of
 Science & Technology (PRIST)
 THANJAVUR - 613 403.



CERTIFICATE COURSE IN INVESTMENT MANAGEMENT

S.NO	REG.NO	NAME	17/07/2023	18/07/2023	19/07/2023	20/07/2023	21/07/2023	25/07/2023	26/07/2023	28/07/2023
1.	2101BM10111	DHINESHWARAN. R.	P	P	P	P	P	P	P	P
2.	2101BM10111	KABILAN. R.	P	P	P	P	P	P	P	P
3.	2101BM10112	PUNITHAN. P	P	P	P	P	P	P	P	P
4.	2101BM10113	SADHAM HUSSAIN. S	P	P	P	P	P	P	P	P
5.	2101BM10114	AROCKIAJAJ. A	P	P	P	P	P	P	P	P
6.	2101BM10114	SRIKANTH. S	P	P	P	P	P	P	P	P
7.	2101BM10115	KABILAN. K	P	P	P	P	P	P	P	P
8.	2101BM10116	ARASU. G	P	P	P	P	P	P	P	P
9.	2101BM10117	SAMEER RAHMAN. M	P	P	P	P	P	P	P	P
10.	2101BM10118	MADHAVARAJ. M	P	P	P	P	P	P	P	P
11.	2101BM10118	GUHAN. G	P	P	P	P	P	P	P	P
12.	2101BM10119	SANTHOSH KUMAR. S	P	P	P	P	P	P	P	P
13.	2101BM10120	SADHAM HUSSAIN. S	P	A	P	P	P	P	P	P
14.	2101BM10120	AJAY MENON	P	P	P	P	P	P	P	P
15.	2101BM10121	PREAMNITHAGAN	P	P	P	P	P	A	P	P
16.	2101BM10122	SARATHY. G. S	P	P	P	P	P	P	P	P
17.	2101BM10123	MAHENDRA DEV. M	P	P	P	P	P	P	P	P
18.	2101BM10124	MOHAMEED THASEEM RAHAMAN M	P	P	P	P	P	P	P	P
19.	2101BM10125	HARI GANESH. G	P	P	P	P	P	P	P	P
20.	2101BM10126	SENTHIL KUMAR. M	P	P	P	P	P	P	P	P
21.	2101BM10127	NAGORE KANI. J	P	P	P	P	P	P	P	P
22.	2101BM10128	MUTHAMILDHASAN. R	P	P	P	P	P	P	P	P
23.	2101BM10129	SANJAY KUMAR. R	P	P	P	P	P	P	P	P
24.	2101BM10130	PRAVIN. H	P	P	P	P	P	P	P	P
25.	2101BM10131	DINESH. V	P	P	P	P	P	P	P	P
26.	2101BM10132	ABIMANI. M	P	P	P	P	P	P	P	P
27.	2101BM10133	AJAYKUMAR P	P	P	P	P	P	P	P	P
28.	2101BM10134	GOKULA PRIYAN. R	P	P	P	P	P	P	P	P



**PONNAIYAH RAMAJAYAM INSTITUTE OF
SCIENCE & TECHNOLOGY (PRIST)**

DECLARED AS DEEMED TO BE UNIVERSITY
U.S. 2 OF 1956 Act, 1956

29.	2101BM10135	HABEEB RAHMAN H	P	P	P	P	P	P	P	P	P	P	P	P	P	P	P	P	P	P
30.	2101BM10135	VIJRA. S	P	P	P	P	P	P	P	P	P	P	P	P	P	P	P	P	P	P
31.	2101BM10136	VENKATESH. R	P	P	P	P	P	P	P	P	P	P	P	P	P	P	P	P	P	P
32.	2101BM10136	MOHAMED FASHITH. B	P	P	P	P	P	P	P	P	P	P	P	P	P	P	P	P	P	P
33.	2101BM10137	SARATH BABU. R	P	P	P	P	P	P	P	P	P	P	P	P	P	P	P	P	P	P
34.	2101BM10138	VISVANATHAN. R	P	P	P	P	P	P	P	P	P	P	P	P	P	P	P	P	P	P
35.	2101BM10139	MADHAVARAJ. M	P	P	P	P	P	P	P	P	P	P	P	P	P	P	P	P	P	P
36.	2101BM10140	KABILAN. V	P	P	P	P	P	P	P	P	P	P	P	P	P	P	P	P	P	P
37.	2101BM10141	JAMAL MOHAMED H	P	P	P	P	P	P	P	P	P	P	P	P	P	P	P	P	P	P
38.	2101BM10142	BHARANIDHARAN P	P	P	P	P	P	P	P	P	P	P	P	P	P	P	P	P	P	P
39.	2101BM10143	SANTHOSH K	P	P	P	P	P	P	P	P	P	P	P	P	P	P	P	P	P	P
40.	2101BM10144	HABEEB RAHMAN H	P	P	P	P	P	P	P	P	P	P	P	P	P	P	P	P	P	P
41.	2101BM10201	SWATHI .M	P	P	P	P	P	P	P	P	P	P	P	P	P	P	P	P	P	P
42.	2101BM10202	MEEGA .M	P	P	P	P	P	P	P	P	P	P	P	P	P	P	P	P	P	P

[Handwritten signatures and initials across the table rows]

[Handwritten signature]
 HOD
 Department of Business Management
 Ponnaiyah Ramajayam Institute of
 Science & Technology (PRIST)
 THANJAVUR - 613 403.

[Handwritten signature]
 DEAN
 School of Business and Management
 Ponnaiyah Ramajayam Institute of
 Science & Technology (PRIST)
 THANJAVUR - 613 403.



**PONNAIYAH RAMAJAYAM INSTITUTE OF
SCIENCE & TECHNOLOGY (PRIST)**

DECLARED AS DEEMED-TO-BE UNIVERSITY
U.S. 3 of 1956 Act, 1956

S.NO	REG.NO	NAME	31/07/2023	01/08/2023	03/08/2023	04/08/2023	08/08/2023	09/08/2023	10/08/2023	14/08/2023
1.	2101BM10111	DHINESHWARAN. R	P	P	P	P	P	P	P	P
2.	2101BM10111	KABILAN. R	P	P	P	P	P	P	P	P
3.	2101BM10112	PUNITHAN. P	P	P	P	P	P	P	P	P
4.	2101BM10113	SADHAM HUSSAIN. S	P	P	P	P	P	P	P	P
5.	2101BM10114	AROCKIARAJ. A	P	P	P	P	P	P	P	P
6.	2101BM10114	SRIKANTH. S	P	P	P	P	P	P	P	P
7.	2101BM10115	KABILAN. K	P	P	P	P	P	P	P	P
8.	2101BM10116	ARASU. G	P	P	P	P	P	P	P	P
9.	2101BM10117	SAMEER RAHMAN. M	P	P	P	P	P	P	P	P
10.	2101BM10118	MADHAVARAJ. M	P	P	P	P	P	P	P	P
11.	2101BM10118	GUHAN. G	P	P	P	P	P	P	P	P
12.	2101BM10119	SANTHOSH KUMAR. S	P	P	P	P	P	P	P	P
13.	2101BM10120	SADHAM HUSSAIN. S	P	A	P	P	P	P	P	P
14.	2101BM10120	AJAY MENON	P	P	P	P	P	P	P	P
15.	2101BM10121	PREAMNITHAGAN	P	P	P	P	P	A	P	P
16.	2101BM10122	SARATHY. G. S	P	P	P	P	P	P	P	P
17.	2101BM10123	MAHENDRA DEV. M	P	P	P	P	P	P	P	P
18.		MOHAMEED THASEEM RAHAMAN M	P	P	P	P	P	P	P	P
19.	2101BM10124	HARI GANESH. G	P	P	P	P	P	P	P	P
20.	2101BM10126	SENTHIL KUMAR. M	P	P	P	P	P	P	P	P
21.	2101BM10127	NAGORE KANI. J	P	P	P	P	P	P	P	P
22.	2101BM10128	MUTHAMILDHASAN. R	P	P	P	P	P	P	P	P
23.	2101BM10129	SANJAY KUMAR. R	P	P	P	P	P	P	P	P
24.	2101BM10130	PRAVIN. H	P	P	P	P	P	P	P	P
25.	2101BM10131	DINESH. V	P	P	P	P	P	P	P	P
26.	2101BM10132	ABIMANI. M	P	P	P	P	P	P	P	P
27.	2101BM10133	AJAYKUMAR P	P	P	P	P	P	P	P	P
28.	2101BM10134	GOKULA PRIYAN. R	P	P	P	P	P	P	P	P
29.	2101BM10135	HABEEB RAHMAN H	P	P	P	P	P	P	P	P
30.	2101BM10135	VIJRA. S	P	P	P	P	P	P	P	P
31.	2101BM10136	VENKATESH. R	P	P	P	P	P	P	P	P



PONNAIYAH RAMAJAYAM INSTITUTE OF SCIENCE & TECHNOLOGY (PRIST)

DECLARATION BY MEMBERS TO BE UNIVERSITY
 1978, 3 of 1978, Act, 1956

32.	2101BM10136	MOHAMED FASHITH. B	P	P	P	P	P	P	P	P	P	P	P	P	P	P	P	P	P
33.	2101BM10137	SARATH BABU. R	P	P	P	P	P	P	P	P	P	P	P	P	P	P	P	P	P
34.	2101BM10138	VISVANATHAN. R	P	P	P	P	P	P	P	P	P	P	P	P	P	P	P	P	P
35.	2101BM10139	MADHAVARAJ. M	P	P	P	P	P	P	P	P	P	P	P	P	P	P	P	P	P
36.	2101BM10140	KABILAN. V	P	P	P	P	P	P	P	P	P	P	P	P	P	P	P	P	P
37.	2101BM10141	JAMAL MOHAMED H	P	P	P	P	P	P	P	P	P	P	P	P	P	P	P	P	P
38.	2101BM10142	BHARANIDHARAN P	P	P	P	P	P	P	P	P	P	P	P	P	P	P	P	P	P
39.	2101BM10143	SANTHOSH K	P	P	P	P	P	P	P	P	P	P	P	P	P	P	P	P	P
40.	2101BM10144	HABEEB RAHMAN H	P	P	P	P	P	P	P	P	P	P	P	P	P	P	P	P	P
41.	2101BM10201	SWATHI .M	P	P	P	P	P	P	P	P	P	P	P	P	P	P	P	P	P
42.	2101BM10202	MEEGA .M	P	P	P	P	P	P	P	P	P	P	P	P	P	P	P	P	P

[Handwritten signatures and initials across the table rows]

[Handwritten signature]
 HOD
 Department of Business Management
 Ponnaiyah Ramajayam Institute of Science & Technology (PRIST)
 THANGAVUR-615 402.

[Handwritten signature]
 DEAN
 School of Commerce and Management
 Ponnaiyah Ramajayam Institute of Science & Technology (PRIST)
 THANGAVUR-615 402.



PONNAIYAH RAMAJAYAM INSTITUTE OF SCIENCE & TECHNOLOGY (PRIST)

DECEASED AS PER MEDICAL UNIVERSITY
 U.S. 31 of 1990 Act, 1956

S.NO	REG.NO	NAME	16/08/2023	17/08/2023	18/08/2023	07/09/2023	08/09/2023	12/09/2023	13/09/2023
1.	2101BM10111	DHINESHWARAN. R	P	P	P	P	P	P	P
2.	2101BM10111	KABILAN. R	P	P	P	P	P	P	P
3.	2101BM10112	PUNITHAN. P	P	P	P	P	P	P	P
4.	2101BM10113	SADHAM HUSSAIN. S	P	P	P	P	P	P	P
5.	2101BM10114	AROCKIARAJ. A	P	P	P	P	P	P	P
6.	2101BM10114	SRIKANTH. S	P	P	P	P	P	P	P
7.	2101BM10115	KABILAN. K	P	P	P	P	P	P	P
8.	2101BM10116	ARASU. G	P	P	P	P	P	P	P
9.	2101BM10117	SAMEER RAHMAN. M	P	P	P	P	P	P	P
10.	2101BM10118	MADHAVARAJ. M	P	P	P	P	P	P	P
11.	2101BM10118	GUHAN. G	P	P	P	P	P	P	P
12.	2101BM10119	SANTHOSH KUMAR. S	P	P	P	P	P	P	P
13.	2101BM10120	SADHAM HUSSAIN. S	P	A	P	P	P	P	P
14.	2101BM10120	AJAY MENON	P	P	P	P	P	P	P
15.	2101BM10121	PREAMNITHAGAN	P	P	P	P	P	A	P
16.	2101BM10122	SARATHY. G. S	P	P	P	P	P	P	P
17.	2101BM10123	MAHENDRA DEV. M	P	P	P	P	P	P	P
18.		MOHAMEED THASEEM RAHAMAN M	P	P	P	P	P	P	P
19.	2101BM10125	HARI GANESH. G	P	P	P	P	P	P	P
20.	2101BM10126	SENTHIL KUMAR. M	P	P	P	P	P	P	P
21.	2101BM10127	NAGORE KANI. J	P	P	P	P	P	P	P
22.	2101BM10128	MUTHAMILDHASAN. R	P	P	P	P	P	P	P
23.	2101BM10129	SANJAY KUMAR. R	P	P	P	P	P	P	P
24.	2101BM10130	PRAVIN. H	P	P	P	P	P	P	P
25.	2101BM10131	DINESH. V	P	P	P	P	P	P	P
26.	2101BM10132	ABIMANI. M	P	P	P	P	P	P	P
27.	2101BM10133	AJAY KUMAR P	P	P	P	P	P	P	P
28.	2101BM10134	GOKULA PRIYAN. R	P	P	P	P	P	P	P
29.	2101BM10135	HABEEB RAHMAN H	P	P	P	P	P	P	P
30.	2101BM10135	VIJRA. S	P	P	P	P	P	P	P
31.	2101BM10136	VENKATESH. R	P	P	P	P	P	P	P
32.	2101BM10136	MOHAMED FASHITH. B	P	P	P	P	P	P	P
33.	2101BM10137	SARATH BABU. R	P	P	P	P	P	P	P
34.	2101BM10138	VISVANATHAN. R	P	P	P	P	P	P	P



PONNAIYAH RAMAJAYAM INSTITUTE OF SCIENCE & TECHNOLOGY (PRIST)

DECLARED AS DEEMED TO BE UNIVERSITY
U.S. 91/1996 ACT, 1996

35.	2101BM10139	MADHAVARAJ. M	P	P	P	P	P	P	P	P
36.	2101BM10140	KABILAN. V	P	P	P	P	P	P	P	P
37.	2101BM10141	JAMAL MOHAMED H	P	P	P	P	P	P	P	P
38.	2101BM10142	BHARANIDHARAN P	P	P	P	P	P	P	P	P
39.	2101BM10143	SANTHOSH K	P	P	P	P	P	P	P	P
40.	2101BM10144	HABEEB RAHMAN H	P	P	P	P	P	P	P	P
41.	2101BM10201	SWATHI .M	P	P	P	P	P	P	P	P
42.	2101BM10202	MEEGA .M	P	P	P	P	P	P	P	P

[Handwritten signatures and initials in the right margin of the table]

[Handwritten signature]
HOD

Department of Business Management
Ponnaiyah Ramajayam Institute of
Science & Technology (PRIST)
THANJAVUR - 613 403.

[Handwritten signature]
DEAN
School of Commerce and Management
Ponnaiyah Ramajayam Institute of
Science & Technology (PRIST)
THANJAVUR - 613 403



CERTIFICATE COURSE BUSINESS WRITING





S.NO	REG.NO	NAME	17/07/2023	18/07/2023	19/07/2023	20/07/2023	21/07/2023	25/07/2023	26/07/2023	28/07/2023
1.	2101BM10203	VIJAYADHARSHINI. T	P	P	P	P	P	P	P	P
2.	2101BM10204	DUVETHA.A.M	P	P	P	P	P	P	P	P
3.	2101BM10205	PAVITHRA.R	P	P	P	P	P	P	P	P
4.	2101BM10206	ANUSIYA.R	P	P	P	P	P	P	P	P
5.	2101BM10207	ARTHI.C	P	P	P	P	P	P	P	P
6.	2101BM10208	VAISHNAVI	P	P	P	P	P	P	P	P
7.	2301BM20129	MOHAMED RIZWAN.R	P	P	P	P	P	P	P	P
8.	2301BM20201	HANNAH.J RESHMA	P	P	P	P	P	P	P	P
9.	2301BM20202	MATHALAEN VINOLIYA.J	P	P	P	P	P	P	P	P
10.	2301BM20203	RESHMA.S	P	P	P	P	P	P	P	P
11.	2301BM20204	MALAVIKAA.V.C	P	P	P	P	P	P	P	P
12.	2301BM20205	GAYATHRI.S	P	P	P	P	P	P	P	P
13.	2301BM20206	PREETHI.P	P	P	P	P	P	P	P	P
14.	2301BM20207	VADIVUKKARASI K	P	P	P	P	P	P	P	P
15.	2301BM20208	JAYABARATHY.S	P	P	P	P	P	P	P	P
16.	2301BM20209	DHANU.SREE.A	P	P	P	P	P	P	P	P
17.	2301BM20210	PAVITHRA.R	P	P	P	P	P	P	P	P
18.	2301BM20211	AMUTHA.P	P	P	P	P	P	P	P	P
19.	2301BM20212	LAKSHMI.PRIYA.J	P	P	P	P	P	P	P	P
20.	2301BM20213	KIRUTHIKA.P	P	P	P	P	P	P	P	P
21.	2301BM20215	SHREE SUBRAJHAA.M	P	P	P	P	P	P	P	P
22.	2301BM20216	PRIYADHARSHINI S	P	P	P	P	P	P	P	P
23.	2301BM20217	ATCHAYA.DEVI.M	P	P	P	P	P	P	P	P
24.	2301BM20218	DHANUSRI.K	P	P	P	P	P	P	P	P
25.	2301BM20219	PRIYADHARSHINI C	P	P	P	P	P	P	P	P
26.	2301BM20220	SUBEKA.S	P	P	P	P	P	P	P	P



**PONNAIYAH RAMAJAYAM INSTITUTE OF
SCIENCE & TECHNOLOGY (PRIST)**

Decolonised UEMED, TO-GE UNIVERSITY
D.S. No. 104 UGC Act, 1956

27.	2301BM20221	HASINA BEGAM S	P	P	P	P	P	P	P	P	P	P	P	P	P	P	P	P	P	P	P	P
28.	2301BM20222	DHANALAKSHMI V	P	P	P	P	P	P	P	P	P	P	P	P	P	P	P	P	P	P	P	P
29.	2301BM20223	AFRIN SAFRA G	P	P	P	P	P	P	P	P	P	P	P	P	P	P	P	P	P	P	P	P
30.	2301BM20224	KEERTHANA J	P	P	P	P	P	P	P	P	P	P	P	P	P	P	P	P	P	P	P	P
31.	2301BM20225	S. PARTHIBAN	P	P	P	P	P	P	P	P	P	P	P	P	P	P	P	P	P	P	P	P
32.	2301BM20226	V. AKASH	P	P	P	P	P	P	P	P	P	P	P	P	P	P	P	P	P	P	P	P
33.	2301BM20227	M. DHINESH KUMAR	P	P	P	P	P	P	P	P	P	P	P	P	P	P	P	P	P	P	P	P
34.	2301BM20228	M. SANJAY KUMAR	P	P	P	P	P	P	P	P	P	P	P	P	P	P	P	P	P	P	P	P
35.	2301BM20229	R. MARS PRAVEEN V.	P	P	P	P	P	P	P	P	P	P	P	P	P	P	P	P	P	P	P	P
36.	2301BM20230	RAMACHANDRAN	P	P	P	P	P	P	P	P	P	P	P	P	P	P	P	P	P	P	P	P
37.	2301BM20231	V. BHARANI	P	P	P	P	P	P	P	P	P	P	P	P	P	P	P	P	P	P	P	P
38.	2301BM20232	S. MANIKANDAN	P	P	P	P	P	P	P	P	P	P	P	P	P	P	P	P	P	P	P	P
39.	2301BM20233	P. GOKUL	P	P	P	P	P	P	P	P	P	P	P	P	P	P	P	P	P	P	P	P
40.	2301BM20234	D. ANAND	P	P	P	P	P	P	P	P	P	P	P	P	P	P	P	P	P	P	P	P
41.	2301BM20235	M. MUKESH	P	P	P	P	P	P	P	P	P	P	P	P	P	P	P	P	P	P	P	P
42.	2301BM20236	T. TAMILSELVAN	P	P	P	P	P	P	P	P	P	P	P	P	P	P	P	P	P	P	P	P





 DEAN
 School of Commerce and Management
 Ponnaiyah Ramajayam Institute of
 Science & Technology (PRIST)
 THANJAVUR-613 403.

 Department of Business Management
 Ponnaiyah Ramajayam Institute of
 Science & Technology (PRIST)
 THANJAVUR-613 403.



**PONNAIYAH RAMAJAYAM INSTITUTE OF
SCIENCE & TECHNOLOGY (PRIST)**

DECLARED AS DEEMED-TO-BE UNIVERSITY
BY THE UGC Act, 1956

S.NO	REG.NO	NAME	31/07/2023	01/08/2023	03/08/2023	04/08/2023	08/08/2023	09/08/2023	10/08/2023	14/08/2023
1.	2101BM10203	VIJAYADHARSHINI. T	P	P	P	P	P	P	P	P
2.	2101BM10204	DUVETHA.A.M	P	P	P	P	P	P	P	P
3.	2101BM10205	PAVITHRA.R	P	P	P	P	P	P	P	P
4.	2101BM10206	ANUSIYA.R	P	P	P	P	P	P	P	P
5.	2101BM10207	ARTHI.C	P	P	P	P	P	P	P	P
6.	2101BM10208	VAISHNAVI	P	P	P	P	P	P	P	P
7.	2301BM20129	MOHAMED RIZWAN.R	P	P	P	P	P	P	P	P
8.	2301BM20201	HANNAH.J RESHMA	P	P	P	P	P	P	P	P
9.	2301BM20202	MATHALAEEN VINOLIYA.J	P	P	P	P	P	P	P	P
10.	2301BM20203	RESHMAS	P	P	P	P	P	P	P	P
11.	2301BM20204	MALAVIKAA.V.C	P	P	P	P	P	P	P	P
12.	2301BM20205	GAYATHRI.S	P	P	P	P	P	P	P	P
13.	2301BM20206	PREETHI.P	P	A	P	P	P	P	P	P
14.	2301BM20207	VADIVUKKARASI K	P	P	P	P	P	P	P	P
15.	2301BM20208	JAYABARATHY.S	P	P	P	P	P	A	P	P
16.	2301BM20209	DHANU.SREE.A	P	P	P	P	P	P	P	P
17.	2301BM20210	PAVITHRAR	P	P	P	P	P	P	P	P
18.	2301BM20211	AMUTHA.P	P	P	P	P	P	P	P	P
19.	2301BM20212	LAKSHMI.PRIYA.J	P	P	P	P	P	P	P	P
20.	2301BM20213	KIRUTHIKA.P	P	P	P	P	P	P	P	P
21.	2301BM20215	SHREE SUBRAJHAA.M	P	P	P	P	P	P	P	P
22.	2301BM20216	PRİYADHARSHINI S	P	P	P	P	P	P	P	P
23.	2301BM20217	ATCHAYA.DEVI.M	P	P	P	P	P	P	P	P
24.	2301BM20218	DHANUSRI.K	P	P	P	P	P	P	P	P
25.	2301BM20219	PRİYADHARSHINI C	P	P	P	P	P	P	P	P
26.	2301BM20220	SUBEKAS	P	P	P	P	P	P	P	P
27.	2301BM20221	HASINA.BEGAM.S	P	P	P	P	P	P	P	P
28.	2301BM20222	DHANALAKSHMI.V	P	P	P	P	P	P	P	P
29.	2301BM20223	AFRIN.SAFRA.G	P	P	P	P	P	P	P	P
30.	2301BM20224	KEERTHANA.J	P	P	P	P	P	P	P	P
31.	2301BM20225	S.PARTHIBAN	P	P	P	P	P	P	P	P



PONNAIYAH RAMAJAYAM INSTITUTE OF SCIENCE & TECHNOLOGY (PRIST)

Declared as DEEMED TO BE UNIVERSITY
12th of UGC Act, 1956

32.	230IBM20226	V. AKASH	P	P	P	P	P	P	P	P	P	P	P	P	P	P	P
33.	230IBM20227	M. DHINESH KUMAR	P	P	P	P	P	P	P	P	P	P	P	P	P	P	P
34.	230IBM20228	M. SANJAY KUMAR	P	P	P	P	P	P	P	P	P	P	P	P	P	P	P
35.	230IBM20229	R. MARS PRAVEEN	P	P	P	P	P	P	P	P	P	P	P	P	P	P	P
36.	230IBM20230	V. RAMACHANDRAN	P	P	P	P	P	P	P	P	P	P	P	P	P	P	P
37.	230IBM20231	V. BHARANI	P	P	P	P	P	P	P	P	P	P	P	P	P	P	P
38.	230IBM20232	S. MANIKANDAN	P	P	P	P	P	P	P	P	P	P	P	P	P	P	P
39.	230IBM20233	P. GOKUL	P	P	P	P	P	P	P	P	P	P	P	P	P	P	P
40.	230IBM20234	D. ANAND	P	P	P	P	P	P	P	P	P	P	P	P	P	P	P
41.	230IBM20235	M. MUKESH	P	P	P	P	P	P	P	P	P	P	P	P	P	P	P
42.	230IBM20236	T. TAMILSELVAN	P	P	P	P	P	P	P	P	P	P	P	P	P	P	P

Handwritten signatures and initials across the table rows.

Handwritten signature
 Department of Business Management
 Ponnaiyah Ramajayam Institute of
 Science & Technology (PRIST)
 Thanjavur-613 403.

Handwritten signature
 DEAN
 School of Commerce and Management
 Ponnaiyah Ramajayam
 Institute of Science & Technology
 Thanjavur-613 403.



**PONNAIYAH RAMAJAYAM INSTITUTE OF
SCIENCE & TECHNOLOGY (PRIST)**

DECLARED AS DEEMED-TO-BE UNIVERSITY
U.S. 1 OF 1986 Act, 1956

S.NO	REG.NO	NAME	16/08/2023	17/08/2023	18/08/2023	07/09/2023	08/09/2023	12/09/2023	13/09/2023
1.	2101BM10203	VIJAYADHARSHINI T	P	P	P	P	P	P	P
2.	2101BM10204	DUVETHA A M	P	P	P	P	P	P	P
3.	2101BM10205	PAVITHRA R	P	P	P	P	P	P	P
4.	2101BM10206	ANUSIYA R	P	P	P	P	P	P	P
5.	2101BM10207	ARTHI C	P	P	P	P	P	P	P
6.	2101BM10208	VAISHNAVI	P	P	P	P	P	P	P
7.	2301BM20129	MOHAMED RIZWAN R	P	P	P	P	P	P	P
8.	2301BM20201	HANNAH J RESHMA	P	P	P	P	P	P	P
9.	2301BM20202	MATHALAEEN VINOLIYA J	P	P	P	P	P	P	P
10.	2301BM20203	RESHMA S	P	P	P	P	P	P	P
11.	2301BM20204	MALAVIKAA V C	P	P	P	P	P	P	P
12.	2301BM20205	GAYATHRI S	P	P	P	P	P	P	P
13.	2301BM20206	PREETHI P	P	A	P	P	P	P	P
14.	2301BM20207	VADIVUKKARASI K	P	P	P	P	P	P	P
15.	2301BM20208	JAYABARATHY S	P	P	P	P	P	A	P
16.	2301BM20209	DHANU SREE A	P	P	P	P	P	P	P
17.	2301BM20210	PAVITHRA R	P	P	P	P	P	P	P
18.	2301BM20211	AMUTHA P	P	P	P	P	P	P	P
19.	2301BM20212	LAKSHMI PRIYA J	P	P	P	P	P	P	P
20.	2301BM20213	KIRUTHIKA P	P	P	P	P	P	P	P
21.	2301BM20215	SHREE SUBRAJHAA M	P	P	P	P	P	P	P
22.	2301BM20216	PRIYADHARSHINI S	P	P	P	P	P	P	P
23.	2301BM20217	ATCHAYA DEVIM	P	P	P	P	P	P	P
24.	2301BM20218	DHANUSRI K	P	P	P	P	P	P	P
25.	2301BM20219	PRIYADHARSHINI C	P	P	P	P	P	P	P
26.	2301BM20220	SUBEKA S	P	P	P	P	P	P	P
27.	2301BM20221	HASINA BEGAM S	P	P	P	P	P	P	P
28.	2301BM20222	DHANALAKSHMI V	P	P	P	P	P	P	P
29.	2301BM20223	AFRIN SAFRA G	P	P	P	P	P	P	P
30.	2301BM20224	KEERTHANA J	P	P	P	P	P	P	P
31.	2301BM20225	S. PARTHIBAN	P	P	P	P	P	P	P
32.	2301BM20226	V. AKASH	P	P	P	P	P	P	P
33.	2301BM20227	M. DHINESH KUMAR	P	P	P	P	P	P	P
34.	2301BM20228	M. SANJAY KUMAR	P	P	P	P	P	P	P
35.	2301BM20229	R. MARS PRAVEEN	P	P	P	P	P	P	P
36.	2301BM20230	V. RAMACHANDRAN	P	P	P	P	P	P	P
37.	2301BM20231	V. BHARANI	P	P	P	P	P	P	P



PONNAIYAH RAMAJAYAM INSTITUTE OF SCIENCE & TECHNOLOGY (PRIST)

DECLARED AS DEEMED TO BE UNIVERSITY
 UTS 1 of UGC Act, 1956

38.	2301BM20232	S. MANIKANDAN	P	P	P	P	P	P	P	P
39.	2301BM20233	P. GOKUL	P	P	P	P	P	P	P	P
40.	2301BM20234	D. ANAND	P	P	P	P	P	P	P	P
41.	2301BM20235	M. MUKESH	P	P	P	P	P	P	P	P
42.	2301BM20236	T. TAMILSELVAN	P	P	P	P	P	P	P	P

Handwritten signatures and initials:
 PPT, PPT, PPT, PPT, PPT, PPT, PPT, PPT, PPT, PPT, PPT

Handwritten signature:
 P. GOKUL

Department of Business Management
 Ponnaiyah Ramajayam Institute of
 Science & Technology (PRIST)
 THANJAVUR - 613 403.

Handwritten signature:
 K. S. J.

DEAN
 School of Commerce and Management
 Ponnaiyah Ramajayam Institute of
 Science & Technology (PRIST)
 THANJAVUR - 613 403.



EVEN-SEM

Certificate Course In Transport and Logistics

S.NO	REG NO	NAME	23/01/2024	24/01/2024	25/01/2024	29/01/2024	30/01/2024	31/01/2024	01/02/2024	02/02/2024
1	2301BM10101	LOGESHB	P	P	P	P	P	P	P	P
2	2301BM10102	SAKTHINAVEENN	P	P	P	P	P	P	P	P
3	2301BM10103	GOWTHAMM	P	P	P	P	P	P	P	P
4	2301BM10104	VINITHK	P	P	P	P	P	P	P	P
5	2301BM10105	AJITHG	P	P	P	P	P	P	P	P
6	2301BM10106	SRINIVASANP	P	P	P	P	P	P	P	P
7	2301BM10107	LOURTHUSAMUVELM	P	P	P	P	P	P	P	P
8	2301BM10108	PUSIPARAJ	P	P	P	P	P	P	P	P
9	2301BM10109	HARISUDHANV	P	P	P	P	P	P	P	P
10	2301BM10110	THIRISARANV	P	P	P	P	P	P	P	P
11	2301BM10111	BHARANIDHARANR	P	P	P	P	P	P	P	P
12	2301BM10112	SATHISHKUMARM	P	P	P	P	P	P	P	P
13	2301BM10113	RAJAGOPALANS	P	A	P	P	P	P	P	P
14	2301BM10114	ADITHYANS K	P	P	P	P	P	P	P	P
15	2301BM10115	PRASANNAR	P	P	P	P	P	A	P	P
16	2301BM10116	SUBASHV	P	P	P	P	P	P	P	P
17	2301BM10117	VENKATESANE	P	P	P	P	P	P	P	P
18	2301BM10118	BALAR	P	P	P	P	P	P	P	P
19	2301BM10119	KISHORE S	P	P	P	P	P	P	P	P
20	2301BM10120	BHARANIDHARANS	P	P	P	P	P	P	P	P
21	2301BM10121	DHARUNKUMARR	P	P	P	P	P	P	P	P
22	2301BM10123	NETHAJIS	P	P	P	P	P	P	P	P
23	2301BM10124	RAMKUMARM	P	P	P	P	P	P	P	P
24	2301BM10126	PRAGATHEESHAS	P	P	P	P	P	P	P	P
25	2301BM10127	DHAMODHARANK	P	P	P	P	P	P	P	P
26	2301BM10128	V.KARTHIK	P	P	P	P	P	P	P	P
27	2301BM10129	P.MADHUBALAN	P	P	P	P	P	P	P	P
28	2301BM10130	P.MANIKANDAN	P	P	P	P	P	P	P	P
29	2301BM10131	A.MOHAMEDFARIS	P	P	P	P	P	P	P	P
30	2301BM10132	S. NIYAZUDEEN	P	P	P	P	P	P	P	P
31	2301BM10133	A.PATTERSON PRASANNA	P	P	P	P	P	P	P	P
32	2301BM10134	V.KAMESH	P	P	P	P	P	P	P	P
33	2301BM10135	RUGIRAJANBAPTISTE	P	P	P	P	P	P	P	P
34	2301BM10136	L. SANTHOSHKUMAR	P	P	P	P	P	P	P	P



**PONNAIYAH RAMAJAYAM INSTITUTE OF
SCIENCE & TECHNOLOGY (PRIST)**

Declared as DEEMED TO BE UNIVERSITY
By D of HGE Act, 1956

35	2301BMT0137	VSAJHISHKUMAR	P	P	P	P	P	P	P	P
36	2301BMT0138	PSIVASAKTHI	P	P	P	P	P	P	P	P
37	2301BMT0139	R. SRIVASHSAN	P	P	P	P	P	P	P	P
38	2301BMT0140	R. THILAKARASAN	P	P	P	P	P	P	P	P
39	2301BMT0141	M.VIGNESHWARAN	P	P	P	P	P	P	P	P
40	2301BMT0142	JESU ABAMUREBEE	P	P	P	P	P	P	P	P
41	2301BMT0143	Y.NANCYXCILIYA	P	P	P	P	P	P	P	P
42	2301BMT0144	CYUZUZOJEANUC	P	P	P	P	P	P	P	P

[Handwritten signatures and initials across the bottom of the table]

HOD

Department of Business Management
Ponnaiyah Ramajayam Institute of
Science & Technology (PRIST)
THANJAVUR-613 403.

DEAN

School of Commerce and Management
Ponnaiyah Ramajayam Institute of
Science & Technology (PRIST)
THANJAVUR-613 403.



**PONNAIYAH RAMAJAYAM INSTITUTE OF
SCIENCE & TECHNOLOGY (PRIST)**

Declared as DEEMED TO BE UNIVERSITY
U/s 3 of UGC Act, 1956

S.NO	REG.NO	NAME	05/02/2024	07/02/2024	09/02/2024	12/02/2024	13/02/2024	15/02/2024	16/02/2024	20/02/2024
1	2301BM10101	LOGESH B	P	P	P	P	P	P	P	P
2	2301BM10102	SAKTHINAVEENN	P	P	P	P	P	P	P	P
3	2301BM10103	GOWTHAMM	P	P	P	P	P	P	P	P
4	2301BM10104	VINITHK	P	P	P	P	P	P	P	P
5	2301BM10105	AJITHG	P	P	P	P	P	P	P	P
6	2301BM10106	SRINIVASANP	P	P	P	P	P	P	P	P
7	2301BM10107	LOURTHUSAMUVELM	P	P	P	P	P	P	P	P
8	2301BM10108	PUSHPARAJ S	P	P	P	P	P	P	P	P
9	2301BM10109	HARISUDHANV	P	P	P	P	P	P	P	P
10	2301BM10110	THIRISARANY	P	P	P	P	P	P	P	P
11	2301BM10111	BHARANIDHARANR	P	P	P	P	P	P	P	P
12	2301BM10112	SATHISHKUMARM	P	P	P	P	P	P	P	P
13	2301BM10113	RAJAGOPALANS	P	A	P	P	P	P	P	P
14	2301BM10114	ADITHYANSK	P	P	P	P	P	P	P	P
15	2301BM10115	PRASANNAR	P	P	P	P	P	A	P	P
16	2301BM10116	SUBASHV	P	P	P	P	P	P	P	P
17	2301BM10117	VENKATESANE	P	P	P	P	P	P	P	P
18	2301BM10118	BALAR	P	P	P	P	P	P	P	P
19	2301BM10119	KISHORE S	P	P	P	P	P	P	P	P
20	2301BM10120	BHARANIDHARANS	P	P	P	P	P	P	P	P
21	2301BM10121	DHARUNKUMARR	P	P	P	P	P	P	P	P
22	2301BM10123	NETHAJIS	P	P	P	P	P	P	P	P
23	2301BM10124	RAMKUMARM	P	P	P	P	P	P	P	P
24	2301BM10126	PRAGATHIESHAS	P	P	P	P	P	P	P	P
25	2301BM10127	DHAMODHARANK	P	P	P	P	P	P	P	P
26	2301BM10128	V.KARTHIK	P	P	P	P	P	P	P	P
27	2301BM10129	PMADHUBALAN	P	P	P	P	P	P	P	P
28	2301BM10130	P.MANIKANDAN	P	P	P	P	P	P	P	P
29	2301BM10131	A.MOHAMEDFARIS	P	P	P	P	P	P	P	P
30	2301BM10132	S. NIYAZUDEEN	P	P	P	P	P	P	P	P
31	2301BM10133	A.PATTERSON PRASANNA	P	P	P	P	P	P	P	P
32	2301BM10134	VRAMESH	P	P	P	P	P	P	P	P
33	2301BM10135	RUGHAJEANBAPTISTE	P	P	P	P	P	P	P	P
34	2301BM10136	I. SANTHOSHKUMAR	P	P	P	P	P	P	P	P
35	2301BM10137	V.SATHISHKUMAR	P	P	P	P	P	P	P	P
36	2301BM10138	PSIVASAKTHI	P	P	P	P	P	P	P	P
37	2301BM10139	R. SRIVASISAN	P	P	P	P	P	P	P	P



PONNAIYAH RAMAJAYAM INSTITUTE OF SCIENCE & TECHNOLOGY (PRIST)

GRANTED AS DEEMED TO BE UNIVERSITY
U.O. 1 OF 005, 2011

16	TC/BA/126	E. THIRUKARASAN	P	P	P	P	P	P	P	P
17	TC/BA/127	M. VIGNESWARAN	P	P	P	P	P	P	P	P
18	TC/BA/128	SR. ABHAMINI	P	P	P	P	P	P	P	P
19	TC/BA/129	T. NAMAYANILYA	P	P	P	P	P	P	P	P
20	TC/BA/130	V. SUDHANILK	P	P	P	P	P	P	P	P

Handwritten signatures and initials are present below the table.

Handwritten signature
 Dean
 School of Commerce and Management
 Ponnaiyah Ramajayam Institute of
 Science & Technology (PRIST)
 Thanjavur - 613 003

Handwritten signature
DEAN
 School of Commerce and Management
 Ponnaiyah Ramajayam Institute of
 Science & Technology (PRIST)
 THANJAVUR - 613 003



**PONNAIYAH RAMAJAYAM INSTITUTE OF
SCIENCE & TECHNOLOGY (PRIST)**

Declared as DEEMED TO BE UNIVERSITY
U/s 3 of UGC Act, 1956

S.NO	REG.NO	NAME	21/02/2024	04/03/2024	05/03/2024	07/03/2024	12/03/2024	13/03/2024	14/03/2024
1	2301BM10101	LOGESH B	P	P	P	P	P	P	P
2	2301BM10102	SAKTHINAVEENN	P	P	P	P	P	P	P
3	2301BM10103	GOWTHAMM	P	P	P	P	P	P	P
4	2301BM10104	VINITHK	P	P	P	P	P	P	P
5	2301BM10105	AJITHG	P	P	P	P	P	P	P
6	2301BM10106	SRINIVASANP	P	P	P	P	P	P	P
7	2301BM10107	LOURTHUSAMUVELM	P	P	P	P	P	P	P
8	2301BM10108	PUSHPARAJ S	P	P	P	P	P	P	P
9	2301BM10109	HARISUDHANV	P	P	P	P	P	P	P
10	2301BM10110	THIRISARANV	P	P	P	P	P	P	P
11	2301BM10111	BHARANIDHARANR	P	P	P	P	P	P	P
12	2301BM10112	SATHISHKUMARM	P	P	P	P	P	P	P
13	2301BM10113	RAJAGOPALANS	P	A	P	P	P	P	P
14	2301BM10114	ADITHIYANS K	P	P	P	P	P	P	P
15	2301BM10115	PRASANNA R	P	P	P	P	P	A	P
16	2301BM10116	SUBASHV	P	P	P	P	P	P	P
17	2301BM10117	VENKATESANE	P	P	P	P	P	P	P
18	2301BM10118	BALAR	P	P	P	P	P	P	P
19	2301BM10119	KISHORE S	P	P	P	P	P	P	P
20	2301BM10120	BHARANIDHARANS	P	P	P	P	P	P	P
21	2301BM10121	DHARUNKUMARR	P	P	P	P	P	P	P
22	2301BM10123	NETHAJIS	P	P	P	P	P	P	P
23	2301BM10124	RAMKUMARM	P	P	P	P	P	P	P
24	2301BM10126	PRAGATHEESHAS	P	P	P	P	P	P	P
25	2301BM10127	DHAMODHARANK	P	P	P	P	P	P	P
26	2301BM10128	VKARTHIK	P	P	P	P	P	P	P
27	2301BM10129	PMADHUBALAN	P	P	P	P	P	P	P
28	2301BM10130	P MANIKANDAN	P	P	P	P	P	P	P
29	2301BM10131	A.MOHAMEDFARIS	P	P	P	P	P	P	P
30	2301BM10132	S. NIYAZUDEEN	P	P	P	P	P	P	P
31	2301BM10133	A PATTERSONPRASANNA	P	P	P	P	P	P	P
32	2301BM10134	VRAMESH	P	P	P	P	P	P	P
33	2301BM10135	RUGRAJFANBAPISTE	P	P	P	P	P	P	P
34	2301BM10136	L. SANTHOSH KUMAR	P	P	P	P	P	P	P
35	2301BM10137	VSATHISHKUMAR	P	P	P	P	P	P	P
36	2301BM10138	PSIVASAKTHI	P	P	P	P	P	P	P
37	2301BM10139	R. SRIVASHAN	P	P	P	P	P	P	P



**PONNAIYAH RAMAJAYAM INSTITUTE OF
SCIENCE & TECHNOLOGY (PRIST)**

Declared as DEEMED TO BE UNIVERSITY
Via 3 of UGC Act, 1956

38	2301BM10140	R. THILAKARASAN	P	P	P	P	P	P	P
39	2301BM10141	M. VIGNESHWARAN	P	P	P	P	P	P	P
40	2301BM10142	JESABAMUREBEE	P	P	P	P	P	P	P
41	2301BM10143	Y. NANCY AXCILYA	P	P	P	P	P	P	P
42	2301BM10144	CYUZUZOJEANLUC	P	P	P	P	P	P	P

[Handwritten signatures and initials]

[Handwritten signature]
HOB

Department of Business Management
Ponnaiyah Ramajayam Institute of
Science & Technology (PRIST)
THANJAVUR - 613 403.

[Handwritten signature]
DEAN

School of Commerce and Management
Ponnaiyah Ramajayam Institute of
Science & Technology (PRIST)
THANJAVUR - 613 403.



**PONNAIYAH RAMAJAYAM INSTITUTE OF
SCIENCE & TECHNOLOGY (PRIST)**

Declared as DEEMED TO BE UNIVERSITY
U/s 3 of UGC Act, 1956

**EVEN-SEM
Certificate Course in Financial risk Management**

S.NO	REG.NO	NAME	23/01/2024	24/01/2024	25/01/2024	29/01/2024	30/01/2024	31/01/2024	01/02/2024	02/02/2024
1.	2301BM10145	TUYSHME CHOROTTUE CARINE	P	P	P	P	P	P	P	P
2	2301BM10146	MUKARWEGOCHRISTINE	P	P	P	P	P	P	P	P
3.	2301BM10147	VAJTHIKUMAR	P	P	P	P	P	P	P	P
4.	2301BM10148	K.SASIKUMAR	P	P	P	P	P	P	P	P
5.	2301BM10149	S.SIVAKUMAR	P	P	P	P	P	P	P	P
6.	2301BM10150	S.KANNAN	A	P	P	P	P	P	P	P
7.	2301BM10151	M.SAMPATHKUMAR	P	P	P	P	P	P	P	P
8.	2301BM10152	D. PRAVEEN	P	P	P	P	P	P	P	P
9.	2301BM10153	S. RAGUL	P	P	P	P	P	P	P	P
10	2301BM10154	A.MANIVANNAN	P	P	P	P	P	P	P	P
11	2301BM10155	H.MOHAMEDASHIK	P	P	P	P	P	P	P	P
12	2301BM10156	J.BHARANIDHARAN	P	P	P	P	P	P	P	P
13	2301BM10157	A.MASHUDEEN	P	A	P	P	P	P	P	P
14	2301BM10201	K. MALARVEZHI	P	P	P	P	P	P	P	P
15	2301BM10202	M. MONIKA	P	P	P	P	P	A	P	P
16	2301BM10203	MANASHAK	P	P	P	P	P	P	P	P
17	2301BM10204	PARKAVIA	P	P	P	P	P	P	P	P
18	2301BM10205	SUSMITHAG	P	P	P	P	P	P	P	P
19	2301BM20101	PRAVEENKUMAR	P	P	P	P	P	P	P	P
20	2301BM20103	KANAGARAJD	P	P	P	A	P	P	P	P
21	2301BM20104	RIZWANULASHRAFH	P	P	P	P	P	P	P	P
22	2301BM20105	PRAKASHRAJAV	P	P	P	P	P	P	P	P
23	2301BM20106	PAVUNRAJ	P	P	P	P	A	P	P	P
24	2301BM20107	MEGHASELVAMS	P	P	P	P	P	P	P	P
25	2301BM20108	PRAVEENKUMARP	P	P	P	P	P	P	P	P
26	2301BM20109	PONMATHAVANP	P	P	P	P	P	P	P	P
27	2301BM20110	NANDHAGOPALA	P	P	P	P	P	P	P	P
28	2301BM20111	SHAMUGAVELS	P	P	P	P	P	P	P	P
29	2301BM20112	KATHIRVELM	P	P	P	P	P	P	P	P
30	2301BM20114	BALAKRISHNAN A	P	P	P	P	P	P	P	P
31	2301BM20115	MANIKAVELS	P	P	P	P	P	P	P	P
32	2301BM20116	RIYAZSAHAMEDM	P	P	P	P	P	P	P	P
33	2301BM20117	AKASHP	P	P	P	P	P	P	P	P
34	2301BM20118	RAJARAMP	P	P	P	P	P	P	P	P
35	2301BM20119	SIVARAJUM	P	P	P	P	P	P	P	P



**PONNAIYAH RAMAJAYAM INSTITUTE OF
SCIENCE & TECHNOLOGY (PRIST)**

Declared as DEEMED TO BE UNIVERSITY
U/s 3 of UGC Act, 1956

36	2301BM20122	ANIRUDTHANR	P	P	P	P	P	P	P	P
37	2301BM20123	RAJADURAIR	P	P	P	P	P	P	P	P
38	2301BM20124	KOWSHIKBALAJI.D.M	P	P	P	P	P	P	P	P
39	2301BM20125	TENDULKARAP	P	P	P	P	P	P	P	P
40	2301BM20126	SIVASANKARV	P	P	P	P	P	P	P	P
41	2301BM20127	RAKESHR	P	P	P	P	P	P	P	P
42	2301BM20128	VIGNESHT	P	P	P	P	P	P	P	P

S. kuni M B. ch. S. kuni M S. kuni M B. ch.

HOD

Department of Business Management
Ponnaiyah Ramajayam Institute of
Science & Technology (PRIST)
THANJAVUR - 613 403.

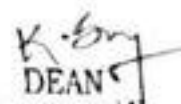
DEAN

School of Commerce and Management
Ponnaiyah Ramajayam Institute of
Science & Technology (PRIST)
THANJAVUR - 613 403.



**PONNAIYAH RAMAJAYAM INSTITUTE OF
SCIENCE & TECHNOLOGY (PRIST)**

Declared as DEEMED TO BE UNIVERSITY
Uir 3 of UGC Act, 1956

SNO	REG NO	NAME	05/02/2024	07/02/2024	09/02/2024	12/02/2024	13/02/2024	15/02/2024	16/02/2024	20/02/2024
1	2301BM10145	TUYSHME CHOROTTUE CARINE	P	P	P	P	P	P	P	P
2	2301BM10146	MUKARWEGO CHRISTINE	P	P	P	P	P	P	P	P
3	2301BM10147	V AJITHKUMAR	P	P	P	P	P	P	P	P
4	2301BM10148	K SASIKUMAR	P	P	P	P	P	P	P	P
5	2301BM10149	S SIVAKUMAR	P	P	P	P	P	P	P	P
6	2301BM10150	S KANNAN	P	P	P	P	P	P	P	P
7	2301BM10151	M SAMPATHKUMAR	P	P	P	P	P	P	P	P
8	2301BM10152	D. PRAVEEN	P	P	P	P	P	P	P	P
9	2301BM10153	S RAGUL	P	P	P	P	P	P	P	P
10	2301BM10154	A MANIVANNAN	P	P	P	P	P	P	P	P
11	2301BM10155	H MOHAMEDASHIK	P	P	P	P	P	P	P	P
12	2301BM10156	J BHARANIDHARAN	P	P	P	P	P	P	P	P
13	2301BM10157	A MASHUDEEN	P	A	P	P	P	P	P	P
14	2301BM10201	K. MALARVIZHI	P	P	P	P	P	P	P	P
15	2301BM10202	M MONIKA	P	P	P	P	P	A	P	P
16	2301BM10203	MANASHAK	P	P	P	P	P	P	P	P
17	2301BM10204	PARKAVIA	P	P	P	P	P	P	P	P
18	2301BM10205	SUSMITHAG	P	P	P	P	P	P	P	P
19	2301BM20101	PRAVEENKUMAR	P	P	P	P	P	P	P	P
20	2301BM20103	KANAGARAJD	P	P	P	P	P	P	P	P
21	2301BM20104	RIZWANULASHRAFI	P	P	P	P	P	P	P	P
22	2301BM20105	FRAKASHRAJAV	P	P	P	P	P	P	P	P
23	2301BM20106	PAVUNRAJP	P	P	P	P	P	P	P	P
24	2301BM20107	MEGHASELVAMS	P	P	P	P	P	P	P	P
25	2301BM20108	PRAVEENKUMARP	P	P	P	P	P	P	P	P
26	2301BM20109	PUNMATHAVANP	P	P	P	P	P	P	P	P
27	2301BM20110	NANDHAGOPALA	P	P	P	P	P	P	P	P
28	2301BM20111	SHAMUGAVELS	P	P	P	P	P	P	P	P
29	2301BM20112	KATHIRVELM	P	P	P	P	P	P	P	P
30	2301BM20114	BALAKRISHNANA	P	P	P	P	P	P	P	P
31	2301BM20115	MANIKAVELS	P	P	P	P	P	P	P	P
32	2301BM20116	KIYAZSAHAMEDM	P	P	P	P	P	P	P	P
33	2301BM20117	ARASHIP	P	P	P	P	P	P	P	P
34	2301BM20118	RAJARAMP	P	P	P	P	P	P	P	P
35	2301BM20119	SIVARAJUM	P	P	P	P	P	P	P	P
36	2301BM20122	ANIRUDTHANR	P	P	P	P	P	P	P	P
37	2301BM20123	RAJADURAIR	P	P	P	P	P	P	P	P



**PONNAIYAH RAMAJAYAM INSTITUTE OF
SCIENCE & TECHNOLOGY (PRIST)**

Declared as DEEMED TO BE UNIVERSITY
U/s 3 of UGC Act, 1956

38	2301BM20124	KOWSHIKBALAJI DM	P	P	P	P	P	P	P	P
39	2301BM20125	TENDULKARAP	P	P	P	P	P	P	P	P
40	2301BM20126	SIVASANKARV	P	P	P	P	P	P	P	P
41	2301BM20127	RAKESH R	P	P	P	P	P	P	P	P
42	2301BM20128	VRGNESHT	P	P	P	P	P	P	P	P

B. Subramanian *K. Ramesh* *S. Kumar* *(Pr)* *S. Kumar*

[Signature]
HOD

Department of Business Management
Ponnaiyah Ramajayam Institute of
Science & Technology (PRIST)
THANJAVUR - 613 403.

[Signature]
DEAN

School of Commerce and Management
Ponnaiyah Ramajayam Institute of
Science & Technology (PRIST)
THANJAVUR - 613 403.



**PONNAIYAH RAMAJAYAM INSTITUTE OF
SCIENCE & TECHNOLOGY (PRIST)**

Declared as DEEMED TO BE UNIVERSITY
U/s 3 of UGC Act, 1956

S.NO	REG.NO	NAME	21/02/2024	04/03/2024	05/03/2024	07/03/2024	12/03/2024	13/03/2024	14/03/2024
1.	2301BM10145	TUYSIME CHOROTTUE CARINE	P	P	P	P	P	P	P
2.	2301BM10146	MUKARWEGOCHRISTINE	P	P	P	P	P	P	P
3.	2301BM10147	VAJITHKUMAR	P	P	P	P	P	P	P
4.	2301BM10148	K.SASIKUMAR	P	P	P	P	P	P	P
5.	2301BM10149	S.SIVAKUMAR	P	P	P	P	P	P	P
6.	2301BM10150	S.KANNAN	P	P	P	P	P	P	P
7.	2301BM10151	M.SAMPATTIKUMAR	P	P	P	P	P	P	P
8.	2301BM10152	D. PRAVEEN	P	P	P	P	P	P	P
9.	2301BM10153	S. RAGUL	P	P	P	P	P	P	P
10.	2301BM10154	A.MANIVANNAN	P	P	P	P	P	P	P
11.	2301BM10155	H.MOHAMEDASHIK	P	P	P	P	P	P	P
12.	2301BM10156	J.BHARANIDHARAN	P	P	P	P	P	P	P
13.	2301BM10157	A.MASHUDEEN	P	A	P	P	P	P	P
14.	2301BM10201	K. MALARVIZHI	P	P	P	P	P	P	P
15.	2301BM10202	M. MONIKA	P	P	P	P	A	P	P
16.	2301BM10203	MANASHAK	P	P	P	P	P	P	P
17.	2301BM10204	PARKAVIA	P	P	P	P	P	P	P
18.	2301BM10205	SUSMITHAG	P	P	P	P	P	P	P
19.	2301BM20101	PRAVEENKUMAR	P	P	P	P	P	P	P
20.	2301BM20103	KANAGARAJD	P	P	P	P	P	P	P
21.	2301BM20104	RIZWANULASHRAFH	P	P	P	P	P	P	P
22.	2301BM20105	PRAKASHRAJAV	P	P	P	P	P	P	P
23.	2301BM20106	PAVUNRAJP	P	P	P	P	P	P	P
24.	2301BM20107	MEGHASELVAMS	P	P	P	P	P	P	P
25.	2301BM20108	PRAVEENKUMARP	P	P	P	P	P	P	P
26.	2301BM20109	PONMATHAVANP	P	P	P	P	P	P	P
27.	2301BM20110	NANDHAGOPALA	P	P	P	P	P	P	P
28.	2301BM20111	SHAMUGAVELS	P	P	P	P	P	P	P
29.	2301BM20112	KATHIRVELM	P	P	P	P	P	P	P
30.	2301BM20114	BALAKRISHNAN A	P	P	P	P	P	P	P
31.	2301BM20115	MANIKAVELS	P	P	P	P	P	P	P
32.	2301BM20116	RIYAZSAHAMEDM	P	P	P	P	P	P	P
33.	2301BM20117	AKASHIP	P	P	P	P	P	P	P
34.	2301BM20118	RAJARAMP	P	P	P	P	P	P	P
35.	2301BM20119	SIVARAJUM	P	P	P	P	P	P	P
36.	2301BM20122	ANIRUDTHANR	P	P	P	P	P	P	P
37.	2301BM20123	RAJADURAIR	P	P	P	P	P	P	P



PONNAIYAH RAMAJAYAM INSTITUTE OF SCIENCE & TECHNOLOGY (PRIST)

Declared as DEEMED-TO-BE UNIVERSITY
U/A 3 of UGC Act, 1956

38	2301BM20124	KOWSHIKBALAJI.D.M	P	P	P	P	P	P	P
39	2301BM20125	TENDULKARAP	P	P	P	P	P	P	P
40	2301BM20126	SIVASANKARV	P	P	P	P	P	P	P
41	2301BM20127	RAKESHR	P	P	P	P	P	P	P
42	2301BM20128	VIGNESHT	P	P	P	P	P	P	P

Handwritten signatures and notes:
K. S. S. K. for *K. Anis Khan* *K. S. S. K.* *P. S. S. K.*

[Signature]
HOD
 Department of Business Management
 Ponnaiyah Ramajayam Institute of
 Science & Technology (PRIST)
 THANJAVUR - 613 403.

[Signature]
DEAN
 School of Commerce and Management
 Ponnaiyah Ramajayam Institute of
 Science & Technology (PRIST)
 THANJAVUR - 613 403.



**PONNAIYAH RAMAJAYAM INSTITUTE OF
SCIENCE & TECHNOLOGY (PRIST)**

Declared as DEEMED-TO-BE UNIVERSITY
U/s 3 of UGC Act, 1956

**SCHOOL OF COMMERCE AND MANAGEMENT
VALUE ADDED COURSE
DEPARTMENT OF MANAGEMENT
CERTIFICATE OF APPRECIATION**

This is to certify that Ms/Mr VIJAYADHARSHINI. T Reg.No 2101BAM10203 has

Completed the value added course on BUSINESS MATHEMATICS
from 17.07.23 to 12.09.23 during the academic year of 2023 to 2024.

COURSE COORDINATOR

HOD

DEAN

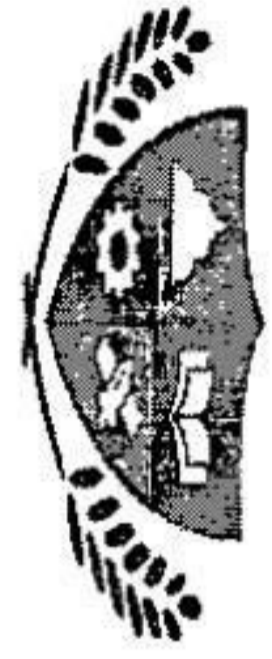

**PONNAIYAH RAMAJAYAM INSTITUTE OF
SCIENCE & TECHNOLOGY (PRIST)**

Declared as DEEMED-TO-BE-UNIVERSITY
U/s 3 of UGC Act, 1956

**SCHOOL OF COMMERCE AND MANAGEMENT
VALUE ADDED COURSE
DEPARTMENT OF MANAGEMENT
CERTIFICATE OF APPRECIATION**

This is to certify that Ms/Mr TIYUSHME CHODROTTE CARME Reg.No 2301BN10145 has

Completed the value added course on FINANCIAL RISK MANAGEMENT

from 23.01.2024 to 14.03.2024 during the academic year of 2023 to 2024.

COURSE COORDINATOR

HOD

DEAN

Department of Management
Ponnaiyah Ramajayam Institute of
Science & Technology (PRIST)
THANJAVUR-613 403.

Department of Management
Ponnaiyah Ramajayam Institute of
Science & Technology (PRIST)
THANJAVUR-613 403.



**PONNAIYAH RAMAJAYAM INSTITUTE OF
SCIENCE & TECHNOLOGY (PRIST)**

Declared as DEEMED-TO-BE UNIVERSITY
U/s 3 of UGC Act, 1956

**SCHOOL OF COMMERCE AND MANAGEMENT
VALUE ADDED COURSE
DEPARTMENT OF MANAGEMENT
CERTIFICATE OF APPRECIATION**

This is to certify that Ms/Mr RAJESH R Reg.No 2201B M20132 has

Completed the value added course on SALES AND MARKETING
from 17.07.2023 to 18.09.2023 during the academic year of 2023 to 2024.

COURSE COORDINATOR

HOD

DEAN



**PONNAIYAH RAMAJAYAM INSTITUTE OF
SCIENCE & TECHNOLOGY (PRIST)**

Declared as DEEMED-TO-BE UNIVERSITY
U/s 3 of UGC Act, 1956

**SCHOOL OF COMMERCE AND MANAGEMENT
VALUE ADDED COURSE
DEPARTMENT OF MANAGEMENT
CERTIFICATE OF APPRECIATION**

This is to certify that Ms/Mr BALUJI.S Reg.No 22012m20157 has

Completed the value added course on DIPLOMA IN TRY PROCEDURE & PRACTICES
from 20.02.2023 to 20.11.2023 during the academic year of 2023 to 2024.

COURSE COORDINATOR

HOD

DEAN



**PONNAIYAH RAMAJAYAM INSTITUTE OF
SCIENCE & TECHNOLOGY (PRIST)**

Declared as DEEMED-TO-BE UNIVERSITY
U/s 3 of UGC Act, 1956

**SCHOOL OF COMMERCE AND MANAGEMENT
VALUE ADDED COURSE
DEPARTMENT OF MANAGEMENT
CERTIFICATE OF APPRECIATION**

This is to certify that Ms/Mr E. VISHWANATHAN Reg.No 22B1BMB10101 has

Completed the value added course on DIPLOMA IN E-BANKING
from 20.07.2023 to 18.12.2023 during the academic year of 2023 to 2024.

COURSE COORDINATOR

HOD

DEAN



**PONNAIYAH RAMAJAYAM INSTITUTE OF
SCIENCE & TECHNOLOGY (PRIST)**

Declared as DEEMED TO BE UNIVERSITY
U/s 3 of UGC Act, 1956

**SCHOOL OF COMMERCE AND MANAGEMENT
VALUE ADDED COURSE
DEPARTMENT OF MANAGEMENT
CERTIFICATE OF APPRECIATION**

This is to certify that Ms/Mr SHINESHWARAN.R Reg.No 2101BM111 has

Completed the value added course on INVESTMENT MANAGEMENT

from 17.07.23 to 18.09.23 during the academic year of 2023 to 2024.

COURSE COORDINATOR

HOD

DEAN

School of Commerce and Management
Ponnaiyah Ramajayam Institute of Science & Technology (PRIST)
Trichy - 620 024

School of Commerce and Management
Ponnaiyah Ramajayam Institute of Science & Technology (PRIST)
Trichy - 620 024

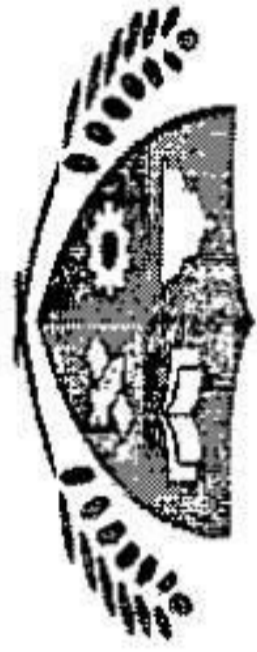

**PONNAIYAH RAMAJAYAM INSTITUTE OF
SCIENCE & TECHNOLOGY (PRIST)**

Declared as DEEMED-TO-BE-UNIVERSITY
U/s 3 of UGC Act, 1956

**SCHOOL OF COMMERCE AND MANAGEMENT
VALUE ADDED COURSE
DEPARTMENT OF MANAGEMENT
CERTIFICATE OF APPRECIATION**

This is to certify that Ms/Mr KABILDAN R Reg.No 2101BMD111 has

Completed the value added course on INVESTMENT MANAGEMENT
from 17.07.23 to 12.09.23 during the academic year of 2023 to 2024.

COURSE COORDINATOR

HOD

DEAN



**PONNAIYAH RAMAJAYAM INSTITUTE OF
SCIENCE & TECHNOLOGY (PRIST)**

Declared as DEEMED-TO-BE-UNIVERSITY
U/s 3 of UGC Act, 1956

**SCHOOL OF COMMERCE AND MANAGEMENT
VALUE ADDED COURSE
DEPARTMENT OF MANAGEMENT
CERTIFICATE OF APPRECIATION**

This is to certify that Ms/Mr PUNITHAN.P Reg.No 2101BMD112 has

Completed the value added course on INVESTMENT MANAGEMENT
from 17.07.23 to 13.09.23 during the academic year of 2023 to 2024.

COURSE COORDINATOR

HOD

DEAN



**PONNAIYAH RAMAJAYAM INSTITUTE OF
SCIENCE & TECHNOLOGY (PRIST)**

Declared as DEEMED-TO-BE UNIVERSITY
U/s 3 of UGC Act, 1956

**SCHOOL OF COMMERCE AND MANAGEMENT
VALUE ADDED COURSE
DEPARTMENT OF MANAGEMENT
CERTIFICATE OF APPRECIATION**

This is to certify that Ms/Mr SR DHARM HUSSAIN . S Reg.No 2101BML0112 has

Completed the value added course on INVESTMENT MANAGEMENT
from 11.07.23 to 13.09.23 during the academic year of 2023 to 2024.

COURSE COORDINATOR

HOD

DEAN



**PONNAIYAH RAMAJAYAM INSTITUTE OF
SCIENCE & TECHNOLOGY (PRIST)**

Declared as DEEMED-TO-BE UNIVERSITY
U/s 3 of UGC Act, 1956

**SCHOOL OF COMMERCE AND MANAGEMENT
VALUE ADDED COURSE
DEPARTMENT OF MANAGEMENT
CERTIFICATE OF APPRECIATION**

This is to certify that Ms/Mr AROCKIAARAJ . A Reg.No 21010M10114 has

Completed the value added course on INVESTMENT MANAGEMENT
from 17.07.23 to 12.09.23 during the academic year of 2023 to 2024.

COURSE COORDINATOR

HOD

DEAN



**PONNAIYAH RAMAJAYAM INSTITUTE OF
SCIENCE & TECHNOLOGY (PRIST)**

Declared as DEEMED-TO-BE UNIVERSITY
U/s 3 of UGC Act, 1956

**SCHOOL OF COMMERCE AND MANAGEMENT
VALUE ADDED COURSE
DEPARTMENT OF MANAGEMENT
CERTIFICATE OF APPRECIATION**

This is to certify that Ms/Mr KARILPN.K Reg.No 21018M10115 has

Completed the value added course on INVESTMENT MANAGEMENT
from 17.07.23 to 18.09.23 during the academic year of 2023 to 2024.

COURSE COORDINATOR

HOD

DEAN



**PONNAIYAH RAMAJAYAM INSTITUTE OF
SCIENCE & TECHNOLOGY (PRIST)**

Declared as DEEMED-TO-BE UNIVERSITY
U/s 3 of UGC Act, 1956

**SCHOOL OF COMMERCE AND MANAGEMENT
VALUE ADDED COURSE
DEPARTMENT OF MANAGEMENT
CERTIFICATE OF APPRECIATION**

This is to certify that Ms/Mr ARADU G Reg.No 2101BmlD11b has

Completed the value added course on INVESTMENT MANAGEMENT
from 17.07.23 to 18.09.23 during the academic year of 2023 to 2024.

COURSE COORDINATOR

HOD

DEAN



**PONNAIYAH RAMAJAYAM INSTITUTE OF
SCIENCE & TECHNOLOGY (PRIST)**

Declared as DEEMED-TO-BE-UNIVERSITY
U/s 3 of UGC Act, 1956

**SCHOOL OF COMMERCE AND MANAGEMENT
VALUE ADDED COURSE
DEPARTMENT OF MANAGEMENT
CERTIFICATE OF APPRECIATION**

This is to certify that Ms/Mr SAIMEER RAHMAN.M Reg.No 2101AM10117 has

Completed the value added course on INVESTMENT MANAGEMENT

from 17.01.23 to 18.09.23 during the academic year of 2023 to 2024.

COURSE COORDINATOR

HOD

DEAN



**PONNAIYAH RAMAJAYAM INSTITUTE OF
SCIENCE & TECHNOLOGY (PRIST)**

Declared as DEEMED-TO-BE UNIVERSITY
U/s 3 of UGC Act, 1956

**SCHOOL OF COMMERCE AND MANAGEMENT
VALUE ADDED COURSE
DEPARTMENT OF MANAGEMENT
CERTIFICATE OF APPRECIATION**

This is to certify that Ms/Mr M ADHARAJ. M Reg.No 21013M10118 has

Completed the value added course on INVESTMENT MANAGEMENT
from 11.07.23 to 13.09.23 during the academic year of 2023 to 2024.

COURSE COORDINATOR

HOD

DEAN



**PONNAIYAH RAMAJAYAM INSTITUTE OF
SCIENCE & TECHNOLOGY (PRIST)**

Declared as DEEMED-TO-BE UNIVERSITY
U/S 3 of UGC Act, 1956

**SCHOOL OF COMMERCE AND MANAGEMENT
VALUE ADDED COURSE
DEPARTMENT OF MANAGEMENT
CERTIFICATE OF APPRECIATION**

This is to certify that Ms/Mr _____

SHYAM . S

Reg.No 21013M1D118 has

Completed the value added course on _____

INVESTMENT MANAGEMENT

_____ from 17.07.23 to 18.09.23 during the academic year of 2023 to 2024.

COURSE COORDINATOR

HOD

DEAN



**PONNAIYAH RAMAJAYAM INSTITUTE OF
SCIENCE & TECHNOLOGY (PRIST)**

Declared as DEEMED-TO-BE UNIVERSITY
U/s 3 of UGC Act, 1956

**SCHOOL OF COMMERCE AND MANAGEMENT
VALUE ADDED COURSE
DEPARTMENT OF MANAGEMENT
CERTIFICATE OF APPRECIATION**

This is to certify that Ms/Mr SRINATHOSH KUMAR S Reg.No 2101230119 has

Completed the value added course on INVESTMENT MANAGEMENT
from 17.07.23 to 13.09.23 during the academic year of 2023 to 2024.

COURSE COORDINATOR

HOD

DEAN

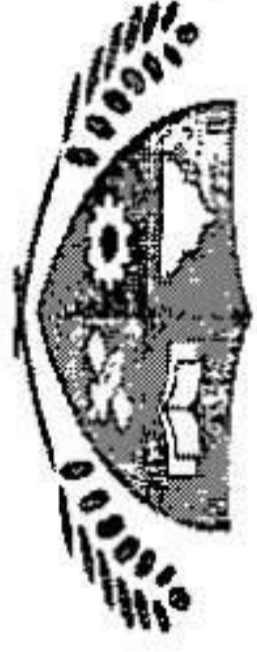

**PONNAIYAH RAMAJAYAM INSTITUTE OF
SCIENCE & TECHNOLOGY (PRIST)**

Declared as DEEMED-TO-BE-UNIVERSITY
U/s 3 of UGC Act, 1956

**SCHOOL OF COMMERCE AND MANAGEMENT
VALUE ADDED COURSE
DEPARTMENT OF MANAGEMENT
CERTIFICATE OF APPRECIATION**

This is to certify that Ms/Mr ABDHAM. MUGSAIN.S Reg.No 2101Bm0920 has

Completed the value added course on INVESTMENT MANAGEMENT
from 17.07.23 to 13.09.23 during the academic year of 2023 to 2024.

COURSE COORDINATOR

HOD

DEAN



**PONNAIYAH RAMAJAYAM INSTITUTE OF
SCIENCE & TECHNOLOGY (PRIST)**

Declared as DEEMED-TO-BE UNIVERSITY
U/s 3 of UGC Act, 1956

**SCHOOL OF COMMERCE AND MANAGEMENT
VALUE ADDED COURSE
DEPARTMENT OF MANAGEMENT
CERTIFICATE OF APPRECIATION**

This is to certify that Ms/Mr ARBY MENON Reg.No 210122M10120 has

Completed the value added course on INVESTMENT MANAGEMENT
from 11.01.23 to 18.09.23 during the academic year of 2023 to 2024.

[Signature]
COURSE COORDINATOR

[Signature]
HOD

[Signature]
DEAN



**PONNAIYAH RAMAJAYAM INSTITUTE OF
SCIENCE & TECHNOLOGY (PRIST)**

Declared as DEEMED-TO-BE UNIVERSITY
U/S 3 of UGC Act, 1956

**SCHOOL OF COMMERCE AND MANAGEMENT
VALUE ADDED COURSE
DEPARTMENT OF MANAGEMENT
CERTIFICATE OF APPRECIATION**

This is to certify that Ms/Mr PREEMNITHARAN Reg.No 21D13M/D121 has

Completed the value added course on INVESTMENT MANAGEMENT
from 17.01.23 to 18.09.23 during the academic year of 2023 to 2024.

[Signature]
COURSE COORDINATOR

[Signature]
HOD

[Signature]
DEAN



**PONNAIYAH RAMAJAYAM INSTITUTE OF
SCIENCE & TECHNOLOGY (PRIST)**

Declared as DEEMED-TO-BE UNIVERSITY
U/s 3 of UGC Act, 1956

**SCHOOL OF COMMERCE AND MANAGEMENT
VALUE ADDED COURSE
DEPARTMENT OF MANAGEMENT
CERTIFICATE OF APPRECIATION**

This is to certify that Ms/Mr SARATHY. G.S Reg.No 2101BAM10122 has

Completed the value added course on INVESTMENT MANAGEMENT
from 17.07.23 to 12.09.23 during the academic year of 2023 to 2024.

COURSE COORDINATOR

HOD

DEAN



**PONNAIYAH RAMAJAYAM INSTITUTE OF
SCIENCE & TECHNOLOGY (PRIST)**

Declared as DEEMED-TO-BE UNIVERSITY
U/s 3 of UGC Act, 1956

**SCHOOL OF COMMERCE AND MANAGEMENT
VALUE ADDED COURSE
DEPARTMENT OF MANAGEMENT
CERTIFICATE OF APPRECIATION**

This is to certify that Ms/Mr MAHENDRA DEV. M Reg.No 2101BMB123 has

Completed the value added course on INVESTMENT MANAGEMENT
from 17.07.23 to 19.09.23 during the academic year of 2023 to 2024.

COURSE COORDINATOR

HOD

DEAN



**PONNAIYAH RAMAJAYAM INSTITUTE OF
SCIENCE & TECHNOLOGY (PRIST)**

Declared as DEEMED-TO-BE UNIVERSITY
U/s 3 of UGC Act, 1956

**SCHOOL OF COMMERCE AND MANAGEMENT
VALUE ADDED COURSE
DEPARTMENT OF MANAGEMENT
CERTIFICATE OF APPRECIATION**

This is to certify that Ms/Mr MOHAMMED THASSEM RAHMAN M Reg.No 2101BMD1024 has

Completed the value added course on INVESTMENT MANAGEMENT
from 17.07.23 to 12.09.23 during the academic year of 2023 to 2024.

COURSE COORDINATOR

HOD

DEAN



**PONNAIYAH RAMAJAYAM INSTITUTE OF
SCIENCE & TECHNOLOGY (PRIST)**

Declared as DEEMED-TO-BE-UNIVERSITY
U/s 3 of UGC Act, 1956

**SCHOOL OF COMMERCE AND MANAGEMENT
VALUE ADDED COURSE
DEPARTMENT OF MANAGEMENT
CERTIFICATE OF APPRECIATION**

This is to certify that Ms/Mr ARRI GANESH.G Reg.No 21018M10125 has

Completed the value added course on INVESTMENT MANAGEMENT
from 17.07.23 to 19.09.23 during the academic year of 2023 to 2024.

COURSE COORDINATOR

HOD

DEAN

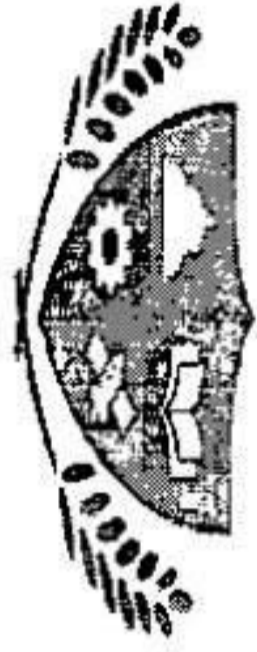

**PONNAIYAH RAMAJAYAM INSTITUTE OF
SCIENCE & TECHNOLOGY (PRIST)**

Declared as DEEMED-TO-BE UNIVERSITY
U/s 3 of UGC Act, 1956

**SCHOOL OF COMMERCE AND MANAGEMENT
VALUE ADDED COURSE
DEPARTMENT OF MANAGEMENT
CERTIFICATE OF APPRECIATION**

This is to certify that Ms/Mr SANDIL KUMAR.M Reg.No 21018M10125 has

Completed the value added course on INVESTMENT MANAGEMENT
from 17.07.23 to 12.09.23 during the academic year of 2023 to 2024.

COURSE COORDINATOR

HOD

DEAN



**PONNAIYAH RAMAJAYAM INSTITUTE OF
SCIENCE & TECHNOLOGY (PRIST)**

Declared as DEEMED-TO-BE-UNIVERSITY
U/s 3 of UGC Act, 1956

**SCHOOL OF COMMERCE AND MANAGEMENT
VALUE ADDED COURSE
DEPARTMENT OF MANAGEMENT
CERTIFICATE OF APPRECIATION**

This is to certify that Ms/Mr NRGORE KANI. J Reg.No 21018m10127 has

Completed the value added course on INVESTMENT MANAGEMENT
from 17.07.23 to 13.09.23 during the academic year of 2023 to 2024.

COURSE COORDINATOR

HOD

DEAN



**PONNAIYAH RAMAJAYAM INSTITUTE OF
SCIENCE & TECHNOLOGY (PRIST)**

Declared as DEEMED-TO-BE UNIVERSITY
U/s 3 of UGC Act, 1956

**SCHOOL OF COMMERCE AND MANAGEMENT
VALUE ADDED COURSE
DEPARTMENT OF MANAGEMENT
CERTIFICATE OF APPRECIATION**

This is to certify that Ms/Mr MUTHAMILLI DIASAN.R Reg.No 2101BMD128 has

Completed the value added course on INVESTMENT MANAGEMENT
from 17.07.23 to 13.09.22 during the academic year of 2023 to 2024.

COURSE COORDINATOR

HOD

DEAN



PONNAIYAH RAMAJAYAM INSTITUTE OF
SCIENCE & TECHNOLOGY (PRIST)

Declared as DEEMED-TO-BE UNIVERSITY
U/s 3 of UGC Act, 1956

SCHOOL OF COMMERCE AND MANAGEMENT
VALUE ADDED COURSE
DEPARTMENT OF COMMERCE
CERTIFICATE OF APPRECIATION

This is to certify that Ms/Mr R Mahadevan Reg.No 2201CM20101 has
Completed the value added course on Certificate Course in GST
from 11/07/23 to 13/09/23 during the academic year of 2023 to 2024.

COURSE COORDINATOR

HOD

DEAN

Department of Commerce
Ponnaiyah Ramajayam Institute of
Science & Technology (PRIST),
Deemed as DEEMED TO BE UNIVERSITY

School of Commerce and Management
Ponnaiyah Ramajayam Institute of
Science & Technology (PRIST)
Pondicherry - 605 003



**PONNAIYAH RAMAJAYAM INSTITUTE OF
SCIENCE & TECHNOLOGY (PRIST)**
Declared as DEEMED-TO-BE UNIVERSITY
U/s 3 of UGC Act, 1956

**SCHOOL OF COMMERCE AND MANAGEMENT
VALUE ADDED COURSE
DEPARTMENT OF MANAGEMENT
CERTIFICATE OF APPRECIATION**

This is to certify that Ms/Mr Sakethinaven N Reg.No 23013M110102 has
Completed the value added course on Certificate Course in Transport and
Logistics from 23/09/24 to 14/03/24 during the academic year of 2023 to 2024.

COURSE COORDINATOR

K. Senthil

K. Senthil
HOD

HOD

K. Senthil
DEAN

DEAN

Department of Business Management
Faculty of Management Studies
SRM Institute of Science and Technology
Thiruvananthapuram - 695 023

School of Commerce and Management
Ponnaiyah Ramajayam Institute of Science and Technology
Thiruvananthapuram - 695 023



PONNAIYAH RAMAJAYAM INSTITUTE OF
SCIENCE & TECHNOLOGY (PRIST)
Declared as DEEMED-TO BE UNIVERSITY
U/s 3 of UGC Act, 1956

SCHOOL OF COMMERCE AND MANAGEMENT
VALUE ADDED COURSE
DEPARTMENT OF MANAGEMENT
CERTIFICATE OF APPRECIATION

This is to certify that Ms/Mr Growtham, M Reg.No 23D13M10103 has
Completed the value added course on Certificate Course in Transport and
Logistic from 22/09/24 to 14/03/24 during the academic year of 2023 to 2024.

COURSE COORDINATOR

HOD

DEAN

Department of Business Management
Ponnaiyah Ramajayam Institute of
Science & Technology (PRIST)
THANJAVUR-613 403.

School of Commerce
Ponnaiyah Ramajayam Institute of
Science & Technology (PRIST)
THANJAVUR-613 403.



**PONNAIYAH RAMAJAYAM INSTITUTE OF
SCIENCE & TECHNOLOGY (PRIST)**
Declared as DEEMED-TO-BE UNIVERSITY
U/s 3 of UGC Act, 1956

**SCHOOL OF COMMERCE AND MANAGEMENT
VALUE ADDED COURSE
DEPARTMENT OF MANAGEMENT
CERTIFICATE OF APPRECIATION**

This is to certify that Ms/Mr Vinitha K Reg.No 2321B1912104 has
Completed the value added course on Certificate Course in Transport and
Logistic from 23/09/24 to 14/03/24 during the academic year of 2023 to 2024.

COURSE COORDINATOR

HOD

DEAN

Department of Business Management

Faculty of Management Studies

Science & Technology (PRIST)

THANJAVUR - 613 403

School of Commerce and Management

Department of Management Studies

Science & Technology (PRIST)

THANJAVUR - 613 403



**PONNAIYAH RAMAJAYAM INSTITUTE OF
SCIENCE & TECHNOLOGY (PRIST)**
Declared as DEEMED-TO-BE UNIVERSITY
U/s 3 of UGC Act, 1956

**SCHOOL OF COMMERCE AND MANAGEMENT
VALUE ADDED COURSE
DEPARTMENT OF MANAGEMENT
CERTIFICATE OF APPRECIATION**

This is to certify that Ms/Mr Dr. Ajith Reg.No 28013M910105 has

Completed the value added course on Certificate Course in Transport and
Logistics from 23/09/24 to 14/03/24 during the academic year of 2023 to 2024.

[Signature]
COURSE COORDINATOR

[Signature]
HOD

[Signature]
DEAN

HOD
Department of Business Management
Ponnaiyah Ramajayam Institute of
Science & Technology (PRIST)
Trichy, Tamil Nadu-613 403

DEAN
School of Commerce and Management
Ponnaiyah Ramajayam Institute of
Science & Technology (PRIST)
Trichy, Tamil Nadu-613 403



**PONNAIYAH RAMAJAYAM INSTITUTE OF
SCIENCE & TECHNOLOGY (PRIST)**
Declared as DEEMED-TO-BE UNIVERSITY
U/s 3 of UGC Act, 1956

**SCHOOL OF COMMERCE AND MANAGEMENT
VALUE ADDED COURSE
DEPARTMENT OF MANAGEMENT
CERTIFICATE OF APPRECIATION**

This is to certify that Ms/Mr Srinivasan P Reg.No 2301BT10106 has

Completed the value added course on Certificate Course in Transport and
Logistics from 28/09/24 to 14/05/24 during the academic year of 2023 to 2024.

[Signature]
COURSE COORDINATOR

[Signature]
HOD

Department of Business Management
Ponnaiyah Ramajayam Institute of
Science & Technology (PRIST)
THANJAVUR - 613 403.

[Signature]
DEAN

School of Commerce and Management
Ponnaiyah Ramajayam Institute of
Science & Technology (PRIST)
THANJAVUR - 613 403.



**PONNAIYAH RAMAJAYAM INSTITUTE OF
SCIENCE & TECHNOLOGY (PRIST)**
Declared as Deemed to be University
U/s 3 of UGC Act, 1956

**SCHOOL OF COMMERCE AND MANAGEMENT
VALUE ADDED COURSE
DEPARTMENT OF MANAGEMENT
CERTIFICATE OF APPRECIATION**

This is to certify that Ms/Mr Lakshmi Saravali M Reg.No 2301BRT10107 has
Completed the value added course on Certificate Course in Transport and
Logistics from 28/09/24 to 14/03/24 during the academic year of 2023 to 2024.

COURSE COORDINATOR

HOD

DEAN

HOD
Department of Business Management
Ponnaiah Ramajayam Institute of
Science & Technology (PRIST)
THANJAVUR-613 403

DEAN
Department of Management
Ponnaiah Ramajayam Institute of
Science & Technology (PRIST)
THANJAVUR-613 403



**PONNAIYAH RAMAJAYAM INSTITUTE OF
SCIENCE & TECHNOLOGY (PRIST)**
Declared as DEEMED-TO-BE UNIVERSITY
U/s 3 of UGC Act, 1956

**SCHOOL OF COMMERCE AND MANAGEMENT
VALUE ADDED COURSE
DEPARTMENT OF MANAGEMENT
CERTIFICATE OF APPRECIATION**

This is to certify that Ms/Mr Pukhpanjari S Reg.No 2301B710108 has
Completed the value added course on Certificate Course in Transport and
Logistics from 28/09/24 to 14/03/24 during the academic year of 2023 to 2024.

COURSE COORDINATOR

[Signature]

HOD

[Signature]

DEAN

[Signature]

Department of Distance Management
Ponnaiyah Ramajayam Institute of
Science & Technology (PRIST)
THANJAVUR - 613 403

School of Commerce and Management
Ponnaiyah Ramajayam Institute of
Science & Technology (PRIST)
THANJAVUR - 613 403



**PONNAIYAH RAMAJAYAM INSTITUTE OF
SCIENCE & TECHNOLOGY (PRIST)**
Declared as DEEMED-TO-BE UNIVERSITY
U/s 3 of UGC Act, 1956

**SCHOOL OF COMMERCE AND MANAGEMENT
VALUE ADDED COURSE
DEPARTMENT OF MANAGEMENT
CERTIFICATE OF APPRECIATION**

This is to certify that Ms/Mr Hanishadhan . V Reg.No 2301BMT0109 has
Completed the value added course on Certificate Course in Transport and
Logistics from 23/09/24 to 14/10/24 during the academic year of 2023 to 2024.

[Signature]
COURSE COORDINATOR

[Signature]
HOD

HOD

DEAN

[Signature]
DEAN

Department of Business Management
Ponnaiyah Ramajayam Institute of
Science & Technology (PRIST)
THANJAVUR - 613 403.

School of Commerce and Management
Ponnaiyah Ramajayam Institute of
Science & Technology (PRIST)
THANJAVUR - 613 403.



**PONNAIYAH RAMAJAYAM INSTITUTE OF
SCIENCE & TECHNOLOGY (PRIST)**
Declared as DEEMED-TO-BE UNIVERSITY
U/s 3 of UGC Act, 1956

**SCHOOL OF COMMERCE AND MANAGEMENT
VALUE ADDED COURSE
DEPARTMENT OF MANAGEMENT
CERTIFICATE OF APPRECIATION**

This is to certify that Ms/Mr Thirivanan, V Reg.No 23D1BNT11112 has
Completed the value added course on Certificate Course on Transport and
Logistics from 23/09/24 to 14/10/24 during the academic year of 2023 to 2024.

COURSE COORDINATOR

V. Senthil

HOD

HOD

Department of Business Management
Ponnaiyah Ramajayam Institute of
Science & Technology (PRIST)
THANJAVUR - 613 403

DEAN

V. Senthil
DEAN

School of Commerce and Management
Ponnaiyah Ramajayam Institute of
Science & Technology (PRIST)
THANJAVUR - 613 403



**PONNAIYAH RAMAJAYAM INSTITUTE OF
SCIENCE & TECHNOLOGY (PRIST)**
Declared as DEEMED-TO-BE UNIVERSITY
U/s 3 of UGC Act, 1956

**SCHOOL OF COMMERCE AND MANAGEMENT
VALUE ADDED COURSE
DEPARTMENT OF MANAGEMENT
CERTIFICATE OF APPRECIATION**

This is to certify that Ms/Mr Bhananidharan. P Reg.No 2301BRI0111 has
Completed the value added course on Certificate Course in Transport and
Logistics from 23/09/24 to 14/03/24 during the academic year of 2023 to 2024.

COURSE COORDINATOR

V. Senthil

HOD

[Signature]

HOD

DEAN

V. Senthil

Department of Business Management

Ponnaiyah Ramajayam Institute of

Science & Technology (PRIST)

THANJAVUR - 613 403.

School of Commerce and Management

Ponnaiyah Ramajayam Institute of

Science & Technology (PRIST)

THANJAVUR - 613 403.



PONNAIYAH RAMAJAYAM INSTITUTE OF
SCIENCE & TECHNOLOGY (PRIST)

Declared as DEEMED TO BE UNIVERSITY
U/s 3 of UGC Act, 1956

SCHOOL OF COMMERCE AND MANAGEMENT
VALUE ADDED COURSE
DEPARTMENT OF MANAGEMENT
CERTIFICATE OF APPRECIATION

This is to certify that Ms/Mr Sathish Kumar. N Reg.No 230131910112 has
Completed the value added course on Certificate Course in Transport and
Logistics from 23/09/24 to 14/03/24 during the academic year of 2023 to 2024.

COURSE COORDINATOR

HOD

DEAN

Department of Business Management
Ponnaiyah Ramajayam Institute of
Science & Technology (PRIST)
THANJAVUR - 613 403.

School of Commerce and Management
Ponnaiyah Ramajayam Institute of
Science & Technology (PRIST)
THANJAVUR - 613 403.



PONNAIYAH RAMAJAYAM INSTITUTE OF
SCIENCE & TECHNOLOGY (PRIST)

Declared as DEEMED-TO-BE UNIVERSITY
U/s 3 of UGC Act, 1956

SCHOOL OF COMMERCE AND MANAGEMENT
VALUE ADDED COURSE
DEPARTMENT OF MANAGEMENT
CERTIFICATE OF APPRECIATION

This is to certify that Ms/Mr Rajagopalan.S Reg.No 2301BMT10118 has
Completed the value added course on Certificate Course in Transport and
Logistics from 23/09/24 to 19/10/24 during the academic year of 2023 to 2024.

COURSE COORDINATOR

HOD

HOD

DEAN

DEAN

Department of Business Management
Ponnaiyah Ramajayam Institute of
Science & Technology (PRIST)
THANJAVUR-613 403.

School of Commerce
Ponnaiyah Ramajayam Institute of
Science & Technology (PRIST)
THANJAVUR-613 403.



**PONNAIYAH RAMAJAYAM INSTITUTE OF
SCIENCE & TECHNOLOGY (PRIST)**
Declared as DEEMED-TO-BE UNIVERSITY
U/s 3 of UGC Act, 1956

**SCHOOL OF COMMERCE AND MANAGEMENT
VALUE ADDED COURSE
DEPARTMENT OF MANAGEMENT
CERTIFICATE OF APPRECIATION**

This is to certify that Ms/Mr Adithyan. S R Reg.No 2301BM10114 has
Completed the value added course on Certificate Course in Transport and
Logistics from 23/09/24 to 14/03/24 during the academic year of 2023 to 2024.

COURSE COORDINATOR

V. Ganesh

HOD

[Signature]

DEAN

V. Ganesh

Department of Management
Ponnaiyah Ramajayam Institute of
Science & Technology (PRIST)
THANJAVUR - 613 403.

School of Commerce and Management
Ponnaiyah Ramajayam Institute of
Science & Technology (PRIST)
THANJAVUR - 613 403.



**PONNAIAH RAMAJAYAM INSTITUTE OF
SCIENCE & TECHNOLOGY (PRIST)**
Declared as DEEMED-TO-BE UNIVERSITY
U/s 3 of UGC Act, 1956

**SCHOOL OF COMMERCE AND MANAGEMENT
VALUE ADDED COURSE
DEPARTMENT OF MANAGEMENT
CERTIFICATE OF APPRECIATION**

This is to certify that Ms/Mr Prasanna . R Reg.No 2301BM10112 has
Completed the value added course on Artifical. Intelligence in Transport and
logistics from 23/09/24 to 14/03/24 during the academic year of 2023 to 2024.

COURSE COORDINATOR

HOD

DEAN

Department of Business Management
Ponnaiah Ramajayam Institute of
Science & Technology (PRIST)
THANJAVUR - 613 403.

School of Commerce and Management
Ponnaiah Ramajayam Institute of
Science & Technology (PRIST)
THANJAVUR - 613 403.



**PONNAIYAH RAMAJAYAM INSTITUTE OF
SCIENCE & TECHNOLOGY (PRIST)**
Declared as DEEMED TO BE UNIVERSITY
U/s 3 of UGC Act, 1956

**SCHOOL OF COMMERCE AND MANAGEMENT
VALUE ADDED COURSE
DEPARTMENT OF MANAGEMENT
CERTIFICATE OF APPRECIATION**

This is to certify that Ms./Mr. Subash . V Reg.No 2301BPT10116 has
Completed the value added course on Artifical Intelligence in Transport and
Logistics from 28/09/24 to 14/08/24 during the academic year of 2023 to 2024.

COURSE COORDINATOR

HOD

HOD

DEAN

Department of Business Management
Ponnaiyah Ramajayam Institute of
Science & Technology (PRIST)
THANJAVUR-613 403

THANJAVUR-613 403



PONNAIYAH RAMAJAYAM INSTITUTE OF
SCIENCE & TECHNOLOGY (PRIST)
Declared as DEEMED-TO-BE UNIVERSITY
U/s 3 of UGC Act, 1956

SCHOOL OF COMMERCE AND MANAGEMENT
VALUE ADDED COURSE
DEPARTMENT OF MANAGEMENT
CERTIFICATE OF APPRECIATION

This is to certify that Ms/Mr Venkatesan, F Reg.No 2301212110117 has
Completed the value added course on Certificate Course in Transport and
Logistics from 23/09/24 to 14/03/24 during the academic year of 2023 to 2024.

COURSE COORDINATOR

K. Sankar

HOD

K. Sankar

DEAN

K. Sankar

Department of Business Management
Ponnaiyah Ramajayam Institute of
Science & Technology (PRIST)
Thanjavur-613 403.

DEAN
Science & Technology (PRIST)
THANJAVUR-613 403.



**PONNAIYAH RAMAJAYAM INSTITUTE OF
SCIENCE & TECHNOLOGY (PRIST)**
Declared as DEEMED-TO-BE-UNIVERSITY
U/s 3 of UGC Act, 1956

**SCHOOL OF COMMERCE AND MANAGEMENT
VALUE ADDED COURSE
DEPARTMENT OF MANAGEMENT
CERTIFICATE OF APPRECIATION**

This is to certify that Ms/Mr Bala . R Reg.No 2301BM10118 has
Completed the value added course on Dertificate Course in Transport and
Logistics from 8/09/24 to 14/03/24 during the academic year of 2023 to 2024.

COURSE COORDINATOR

HOD

HOD

DEAN

Department of Business Management
Ponnaiyah Ramajayam Institute of
Science & Technology (PRIST)
THANJAVUR- 613 403

School of Commerce and Management
Ponnaiyah Ramajayam Institute of
Science & Technology (PRIST)
THANJAVUR- 613 403

THANJAVUR- 613 403

THANJAVUR- 613 403



PONNAIYAH RAMAJAYAM INSTITUTE OF
SCIENCE & TECHNOLOGY (PRIST)
Declared as DEEMED TO BE UNIVERSITY
U/s 3 of UGC Act, 1956

SCHOOL OF COMMERCE AND MANAGEMENT
VALUE ADDED COURSE
DEPARTMENT OF MANAGEMENT
CERTIFICATE OF APPRECIATION

This is to certify that Ms/Mr Vishnu . S Reg.No 2801B1910119 has
Completed the value added course on Certificate Course in Transport and
Logistics from 28/09/24 to 14/03/24 during the academic year of 2023 to 2024.

V. Sankar
COURSE COORDINATOR

V. Sankar
HOD

V. Sankar
DEAN

HOD

DEAN

Department of Business Management
Ponnaiyah Ramajayam Institute of
Science & Technology (PRIST)
THANJAVUR - 613 403.

Department of Business Management
Ponnaiyah Ramajayam Institute of
Science & Technology (PRIST)
THANJAVUR - 613 403.



**PONNAIYAH RAMAJAYAM INSTITUTE OF
SCIENCE & TECHNOLOGY (PRIST)**
Declared as DEEMED TO BE UNIVERSITY
U/s 3 of UGC Act, 1956

**SCHOOL OF COMMERCE AND MANAGEMENT
VALUE ADDED COURSE
DEPARTMENT OF MANAGEMENT
CERTIFICATE OF APPRECIATION**

This is to certify that Ms/Mr Phanna Kumar P Reg.No 2301B1910121 has
Completed the value added course on Certificate Course in Transport and
Logistics from 23/09/24 to 14/03/24 during the academic year of 2023 to 2024.

[Signature]
COURSE COORDINATOR

[Signature]
HOD

[Signature]
DEAN

Department of Business Management
Ponnaiyah Ramajayam Institute of
Science & Technology (PRIST)
THANJAVUR - 613 404

School of Commerce and Management
Ponnaiyah Ramajayam Institute of
Science & Technology (PRIST)
THANJAVUR - 613 404



**PONNAIYAH RAMAJAYAM INSTITUTE OF
SCIENCE & TECHNOLOGY (PRIST)**
Declared as DEEMED TO BE UNIVERSITY
U/s 3 of UGC Act, 1956

**SCHOOL OF COMMERCE AND MANAGEMENT
VALUE ADDED COURSE
DEPARTMENT OF MANAGEMENT
CERTIFICATE OF APPRECIATION**

This is to certify that Ms/Mr Nedhaji. S Reg.No 2821BM10123 has
Completed the value added course on Certificate Course in Transport and
Logistics from 29/09/24 to 14/10/24 during the academic year of 2023 to 2024.

[Signature]
COURSE COORDINATOR

[Signature]
HOD

[Signature]
DEAN

Department of Management Studies
Ponnaiyah Ramajayam Institute of Science & Technology
Principals Office
Pondicherry - 605 006
Phone: 0426-2511111
Fax: 0426-2511112
E-mail: prist@prist.ac.in
www.prist.ac.in



**PONNAIYAH RAMAJAYAM INSTITUTE OF
SCIENCE & TECHNOLOGY (PRIST)**
Declared as DEEMED TO BE UNIVERSITY
U/s 3 of UGC Act, 1956

**SCHOOL OF COMMERCE AND MANAGEMENT
VALUE ADDED COURSE
DEPARTMENT OF MANAGEMENT
CERTIFICATE OF APPRECIATION**

This is to certify that Ms/Mr Ramkumar. N Reg.No 2301131410124 has
Completed the value added course on Artifiticate Genie in Transport and
Logistics from 28/09/2020 14/03/24 during the academic year of 2023 to 2024.

[Signature]
COURSE COORDINATOR

[Signature]
HOD

[Signature]
DEAN

HOD
Department of Business Management
Ponnaiyah Ramajayam Institute of
Science & Technology (PRIST)
THANJAVUR-613 003

DEAN
School of Commerce and Management
Ponnaiyah Ramajayam Institute of
Science & Technology (PRIST)
THANJAVUR-613 003



**PONNAIYAH RAMAJAYAM INSTITUTE OF
SCIENCE & TECHNOLOGY (PRIST)**

Established as Deemed to be University
by U.O. of UGC, New Delhi, 1999

ACADEMIC YEAR

2023-2024

SCHOOL OF COMMERCE AND MANAGEMENT

DEPARTMENT OF COMMERCE

PRIST/C&M/23-24/3.2

This Is To Inform All Commerce Students That The Value Added Course Classes For The Academic Year 2023-2024 Odd Semester Will Be Commenced From 12.07.2023. Hence Requesting All Registered Students To Attend The Classes Without Fail.

COURSES OFFERED:

- Diploma in Event Management
- Certificate Course in Intellectual Property Rights
- Certificate Course in Mutual Fund Operations
- Certificate Course in E-Filing of Income Tax (IRT&TDS)
- Certificate course in GST
- Certificate Course in Business Process services in Insurance
- Certificate Course in Sales force Business Administration Specialist

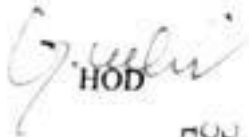
HOD

HOD,
Department of Commerce
Ponnaiyah Ramajayam Institute of
Science & Technology (PRIST)
PRIST is DEEMED TO BE UNIVERSITY

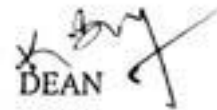
DEAN

DEAN
School of Commerce and Management
Ponnaiyah Ramajayam Institute of
Science & Technology (PRIST)
THANJAVUR - 613 403.

Copy To:

Hon'ble Vice Chancellor (For Your Kind Information)
Registrar
Registrar Office
Dean
Department File



PONNAYAH RAMAJAYAM INSTITUTE OF SCIENCE & TECHNOLOGY (PRIST)

Declared as DEEMED TO BE UNIVERSITY
U/s 3 of UGC Act, 1956

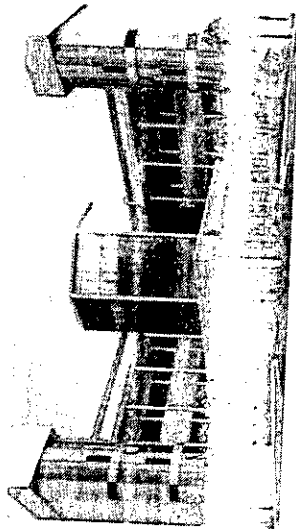

ABOUT UNIVERSITY:

PRIST University, Ponnaiyah Ramajayam Institutions, made a foray into the Academic Domain, with the establishment of Sri Ram Institute of Computer Science and Technology in 1985. Over time, various institutions of higher learning such as Arts and Science College, commerce and business management College of Ponnaiyah Ramajayam Institute of Science & Technology, Education, Research Institution, Polytechnic college are added feathers to the PRIST crown.

DEPARTMENT OF COMMERCE

The department of commerce and business management was established in the year 2008, with commerce Dept focused on research and education different courses like Undergraduate/Postgraduate/M.Phil and Ph.D programs offered. In this department there are 19 faculty members (Professor, Associate and Assistant Professor The faculty offers B.Com, BBA, M.Com, MBA and research programmes in Accountancy, Finance, Business administration, Banking & Business Economics, Human Resource Management, Marketing Management, Retail Management, Family Business & Entrepreneurship etc.

ADD -ON COURSES

B.COM-PROGRAMME

- DIPLOMA COURSE IN EVENT MANAGEMENT
- CERTIFICATE COURSE IN INTELLECTUAL PROPERTY RIGHTS
- CERTIFICATION COURSE IN MUTUAL FUND OPERATION
- CERTIFICATE COURSE IN E-FILLING OF INCOME TAX (IRT&TDS)

2023-2024

LOGISTICS EVENT MANAGEMENT
 BRAND MANAGEMENT
 FESTIVALS PROJECT TECHNICAL
 AUDIENCE
 MARKETING
 ORGANIZATION
 CONCEPT CREATION
 PLANNING

[Handwritten Signature]
HOD

Department of Commerce
Ponnaiyah Ramajayam Institute of Science & Technology (PRIST),
Declared as DEEMED TO BE UNIVERSITY

APPLICATION FORM:

1. FULL NAME _____
2. PROGRAMME _____
3. DISCIPLINE _____
4. INSTITUTION NAME _____
5. DATE-OF BIRTH _____
6. SEX (F/M) _____
7. E-MAIL _____
8. MOBILE NO _____
9. ADDRESS _____

Signature of the Applicant

SUBMISSION OF APPLICATION FORM

Submit your application form in person to the coordinators, school of commerce and Business and Management, PRIST University Thanjavur, vallam,-613403.

APPLICATION MAY BE SEND TO
COURSE CO-ORDINATOR:

K.SATHYA
Head of the department
PRIST University, Thanjavur, Thanjavur.

[Handwritten Signature]
DEAN
School of Commerce and Management
Ponnaiyah Ramajayam Institute of
Science & Technology (PRIST)
THANJAVUR - 613 403.

INTRODUCTION

Event Management is the process of analysing, planning, marketing, producing and evaluating an event. It is a different way of promoting a product, service or idea. If an event is managed efficiently and effectively, it can be used as a very powerful promotional tool to launch or market a product or service.

IMPORTANCE OF EVENT MANAGEMENT

Effective event management can be time-saving as well as money-saving. It saves time in such a manner that event planners already have connections with hotels and venues where an event will take place. They can also choose the best location, place or chooses other venues.

OBJECTIVES OF PROGRAM

The event management process are to: Detect all changes of state that have significance for the management of a CI or IT service. Determine the appropriate control action for events, and ensure these are communicated to the appropriate functions.

DURATION OF PROGRAM

90 Hours add on certificate course

PROGRAM OUTCOME

- PO 1 To learn the concepts related to various events.
- PO2- Awareness on the process of conducting events.
- PO3 -Planning and Budgeting of the events.
- PO 4- Develop critical thinking skills in students

ELIGIBILITY CRITERIA AND FEE

STRUCTURE

Any graduate shall be eligible for the admission to the course .

CERTIFICATION:

The candidates successfully qualifying the course shall be awarded a certificate in the appropriate form by school of commerce and Business Management, Department of Commerce, PRIST University, Thanjavur, Tamil Nadu.



HOD

Department of Commerce
Ponnaiyah Ramajayam Institute of
Science & Technology (PRIST)
Declared as DEEMED TO BE UNIVERSITIES



DEAN

School of Commerce and Management
Ponnaiyah Ramajayam Institute of
Science & Technology (PRIST)
THANJAVUR - 613 403.



PONNAYAH RAMAJAYAM INSTITUTE OF
SCIENCE & TECHNOLOGY (PRIST)

DEEMED TO BE UNIVERSITY
U.S. 1956 Act, 1956

Academic year: 2023-2024
Course: Diploma In Event Management
Subject Code: 2261EM

AIM: To emphasis Better performance in event management

OBJECTIVES:

- The objective is to provide students with a conceptual framework of Event Management, Event Services, Conducting Event and Managing Public Relations.
- To make the students aware about the different events.

OUTCOMES:

- To learn the concepts related to various events.
- Awareness on the process of conducting events.
- Planning and Budgeting of the events.

UNIT 1:

Introduction to event

Event- Meaning of event- Role for Event Management- Analysis of Event, Scope of Event, Decision Makers-Event Manager, Technical Staff- Establishing of Policies and Procedure- Developing Record Keeping Systems.

UNIT 2:

Event management process

Principles for holding an event, General Details, Permissions- Policies, Government and Local Authorities, - Phonographic Performance License, Utilities- Fire brigade, Ambulance, Catering, Electricity, Water, Taxes Applicable.

UNIT 3:

Conduct of an event

Preparing a Planning Schedule, Organizing Tables, Assigning Responsibilities, Communication and Budget of Event- Checklist of Computer aided Event Management- Roles & Responsibilities of Event Managers for Different Events.

UNIT 4:

Public relations

Introductions to Public Relations- Concept- Nature- Importance- Limitations- Media- Types of Media- Media Management, Public Relation Strategy & Planning. Brain Storming for idea generation- Writings for Public Relations

UNIT 5:

Corporate events

Planning of Corporate Events, Job Responsibility of Corporate Events Organizer, Arrangements, Budgeting, Safety of Guest and Participants, Creating Blue Print, Need for Entertainment in Corporate Events and Reporting..

BOOKS FOR REFERENCE:

1. Event Entertainment and Production - Author: Mark Sonderrm CSEP Publisher: Wiley& Sons, Inc.
2. Ghouse Basha – Advertising & Media Mgt, VBH.
3. Anne Stephen – Event Management, HPH.
4. K. Venkataramana. Event Management, SHBP

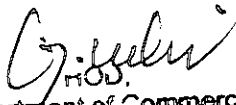

HOD,
Department of Commerce
Ponnaiyah Ramajayam Institute of
Science & Technology (PRIST),
Declared as DEEMED TO BE UNIVERSITY



DEAN
School of Commerce and Management
Ponnaiyah Ramajayam Institute of
Science & Technology (PRIST)
TRANJAYUR-613 403.

INTRODUCTION

Introduction of intellectual property rights is a basic guide to the legal rights of individuals or organizations that own intellectual property (IP). Intellectual property refers to intangible property that results from creative mental work, such as an invention, design, idea, method, name, or symbol.

IMPORTANCE OF INTELLECTUAL PROPERTY RIGHTS

Intellectual Property is often what sets your business apart from the competition and creates a competitive edge that can propel your business forward. Customer loyalty – Creating a brand and/or product that customers grow to love and trust will ensure that customers keep coming back for more.

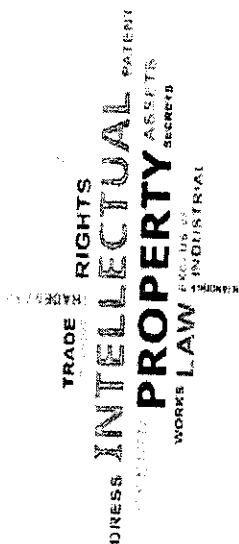

OBJECTIVES OF PROGRAM

IPR provide certain exclusive rights to the inventors or creators of that property, in order to enable them to reap commercial benefits from their creative efforts or reputation. There are several types of intellectual property protection like patent, copyright, trademark, etc

DURATION OF PROGRAM

45 Hours add on certificate course

PROGRAM OUTCOME

- PO-1 Learner should be able to demonstrate understanding of basic concepts of IPR.
- PO-2 Able to differentiate between Trademarks, Trade secrets and GI of goods.
- PO-3 Able to understand Copyrights, Patents and Industrial Designs..
- PO-4 Will gain Knowledge on Cyber law

ELIGIBILITY CRITERIA AND FEE

STRUCTURE

Any graduate shall be eligible for the admission to the course .

CERTIFICATION:

The candidates successfully qualifying the course shall be awarded a certificate to that effect in the appropriate form by school of commerce and Business Management, Department of Commerce, PRIST University ,Thanjavur, Vallam.

Department of Commerce
Ponnaiyah Ramajayam Institute of
Science & Technology (PRIST)
Declared as DEEMED TO BE UNIVERSITY

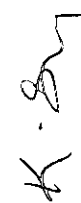
DEAN
School of Commerce and Management
Ponnaiyah Ramajayam Institute of
Science & Technology (PRIST)
THANJAVUR - 613 403.



PONNAYAH RAMAJAYAM INSTITUTE OF
SCIENCE & TECHNOLOGY (PRIST)

Declared as DEEMED TO BE UNIVERSITY
U/s 3 of UGC Act, 1956

Course- Intellectual Property Rights
Subject Code: 2261IPR
2023-2024

AIMS: To emphasis Better performance in Intellectual property rights.

OBJECTIVES:

To provide comprehensive knowledge to the students regarding the general principles of IPR, Concept and Theories, Criticisms of Intellectual Property Rights, International Regime Relating to IPR

OUTCOMES:

comprehensive knowledge to the students regarding the effect of IPR especially of patents on emerging issues like public health, climate, Domain Name Disputes and Cyber squatting, Bio piracy etc. and the ways to tackle this problem.

UNIT-I

Copyright and Neighbouring Rights Concept and Principles Historical background and Development of Copyright Law Leading International Instruments. Berne Convention, Universal Copyright Convention, International Copyright under Copyright Act

WIPO Phonograms and Performances treaty

UNIT-II

Terms of Copyright conditions for grant of copyright, extent of rights exception to copyright protection, fair use provision, assignment and licensing, Copyright in Literary, Dramatic and Musical Works, Sound Recording, Cinematograph Films, Copyright in Computer Programme, Author Special Rights, Right of Broadcasting and performers.

UNIT-III

Copyright Registrar and Copyright Board-Power and Procedure Copyright Societies, Ownership, Assignment, Licence, Translation of Copyright, Compulsory Licences, Infringement-Criteria of Infringement, Infringement of Copyright-Films, Literary and Dramatic works, Importation and Infringement

UNIT-IV

Historical development of the concept of trademark and trademark law-National and International Introduction to Trademarks Need for Protection .Kinds of trademarks

Concept of Well known trademark

UNIT-V

Implications on intellectual property Rights: International & National legal preparedness Application of copyright Act 1957, Scope of protection of computer program Applications of patents to computer technology

Text & References:

- W.R. Cornish, Intellectual Property, Sweet & Maxwell, London (2000)
- Avtar Singh, Competition Law, Eastern Book Company
- Dr. H. K. Saharay, Textbook on Competition Law, Universal Publications
- Brinkhof (Edited), Patent Cases, Wolters Kluwer
- Hilary Pearson and Clifford Miller, Commercial Exploitation of Intellectual Property

HOD,
Department of Commerce
Ponnaiyah Ramajayam Institute of
Science & Technology (PRIST),
Declared as DEEMED TO BE UNIVERSITY

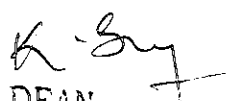

DEAN
School of Commerce and Management
Ponnaiyah Ramajayam Institute of
Science & Technology (PRIST)
THANJAVUR 613 403. Page 135 of 1367

INTRODUCTION

A mutual fund is a company that pools money from many investors and invests the money in securities such as stocks, bonds, and short-term debt. The combined holdings of the mutual fund are known as its portfolio.

IMPORTANCE OF MUTUAL FUND OPERATION

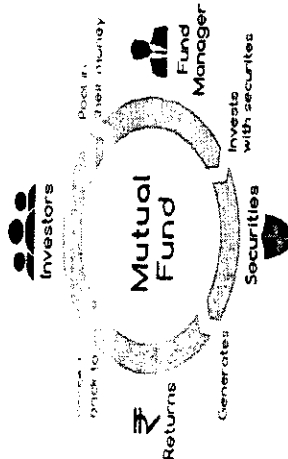
The principal goal of a mutual fund is to offer diversification. Because a mutual fund invests in many securities and companies, the investor automatically diversifies their portfolio by investing in one



OBJECTIVES OF PROGRAM

Mutual funds offer investors the benefits of diversification, which is achieved by investing across different sectors and asset classes. This helps in reducing the overall risk of the portfolio and ensuring a well-diversified investment that can provide better returns that are also often inflation adjusted.

DURATION OF PROGRAM

45 Hours add on certificate course

PROGRAM OUTCOME

PO-1 This course covers all essential topics that will enhance the knowledge of students in Mutual Fund industry.

PO-2 It covers topics related to the basics of Mutual Funds, their role and structure, different kinds of Mutual Fund Schemes and their features.

PO-3 This course discusses the various services offered to present and prospective investors

ELIGIBILITY CRITERIA AND FEESTRUCTURE

Any graduate shall be eligible for the admission to the course

CERTIFICATION:

The candidates successfully qualification the course shall be awarded a certificate to that effect in the appropriate form by school of commerce and Business Management Department of Commerce, PRIST University, Thanjavur, Vallam.

Department of Commerce
Ponnaiyah Ramajayam Institute of
Science & Technology (PRIST)
Declared as DEEMED TO BE UNIVERSITY

DEAN
School of Commerce and Management
Ponnaiyah Ramajayam Institute of
Science & Technology (PRIST)
THANJAVUR - 613 403.



Academic year: 2023-2024

Course- Mutual Fund Operation

Subject Code: 2261MF

AIMS: To emphasize Better performance in mutual fund operation

COURSE OBJECTIVES:

- To provide basic knowledge about the Growth and Role of Mutual funds
- To understand Investors Protection and Regulation of Mutual funds etc.
- Students will be able to understand calculation of net asset value for various mutual funds

OUTCOMES:

- Students will be able to develop an appropriate portfolio for a given investor and market conditions.
- Students will be able to use adjusted financial statements to produce a sound valuation of a company.

UNIT - I

Introduction: The origin, meaning and growth of Mutual funds – Fund Units Vs shares. Types of Mutual fund schemes. The role of Mutual Funds. Organization of the Fund- Operation of the Fund – Net Asset Value meaning and calculation.

UNIT- II

Investors Protection and Mutual Fund Regulation - Investors Rights - Facilities available to Investors - Selection of a Fund - Advantages of Mutual Funds - Deregulation

UNIT- III

Market Imperfection and Investment Risks - The need for Regulation - Regulation and Investors Protection in India

UNIT -IV

Mutual Funds in India -- UTI Schemes, SBI Mutual Fund, Other Mutual Funds - Selection of a Fund. Problems on mutual fund returns

UNIT- V

Mutual Funds Industry in India - Its size and Growth - Types and growth patterns of Mutual Funds – Reasons for slow Growth – Prospects of Mutual Fund Industry

BOOKS FOR REFERENCE:

1. K.G. Sahadevan and M. Chiripairaju: "Mutual funds, data interpretation and Analysis"
(Prentice Hall of India)
 2. V.K. Avadhani: Marketing of Financial Services (Himalaya)
- R.Gorden and Natarajan: Emerging scenario of Financial Services
(Himalaya)

HOD,
Department of Commerce
Ponnaiyah Ramajayam Institute of
Science & Technology (PRIST),
Declared as DEEMED TO BE UNIVERSITY

DEAN
School of Commerce and Management
Ponnaiyah Ramajayam Institute of
Science & Technology (PRIST)
THANJAVUR - 613 403

INTRODUCTION

Electronic filing is the process of submitting tax returns via the internet. It's available from professional tax preparers, through guided preparation software that has been preapproved by the Internal Revenue Service (IRS) or free fillable forms on the IRS site.

IMPORTANCE OF E-FILING OF INCOME TAX

Electronic filing is required to file returns. Compared to paper filing techniques, filing it electronically saves a lot of time. E-filing allows taxpayers to digitally enter and submit their information, eliminating the need for paper forms and manual processing.

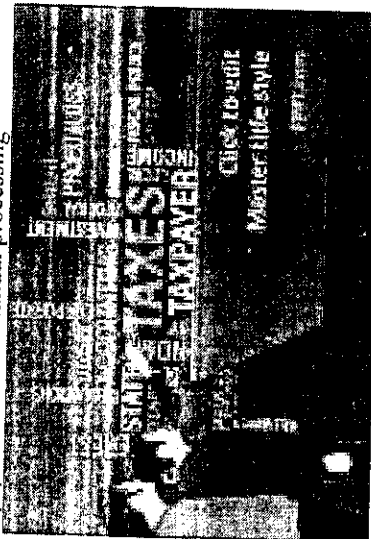

OBJECTIVES OF PROGRAM

The main objectives of the Income Tax Act are promoting price stability, full employment, economic development, reduction of BOP difficulties, controlling cyclical fluctuations and non-revenue objectives.

DURATION OF PROGRAM

45 Hours add on certificate course

PROGRAM OUTCOME

PO-1 This course covers all essential topics that will enhance the knowledge of students in Tax and e-filing .

PO-2 It covers topics related to the basics of tax and income, their role and structure, different kinds of tax procedure and Schemes and their features.

PO-3 This course discusses the various services offered to present and prospective e-filing .

ELIGIBILITY CRITERIA AND FEESTRUCTURE

Any graduate shall be eligible for the admission to the course.

CERTIFICATION:

The candidates successfully qualification the course shall be awarded a certificate to that effect in the appropriate form by school of commerce and Business Management Department of Commerce, PRIST University, Thanjavur, Vallam.

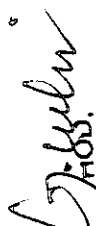
HOD,
Department of Commerce
Ponnamyathur Ramajayam Institute of
Science & Technology (PRIST),
Deemed to be UNIVERSITY

DEAN
School of Commerce and Management
Ponnamyathur Ramajayam Institute of
Science & Technology (PRIST)
THANJAVUR - 613 403.

Course- Certificate in E-filing of Income Tax (IRT&TDS)
Subject Code: 2261ET
2023-2024

AIMS: To emphasis Better performance in E-Filling of Income Tax.

OBJECTIVES

- To help the students to understand the relevance and significance of Tax.
- To facilitate the students in understanding the various Provisions I.T. Act.

OUTCOME:

The students will understand the procedure for computing taxable income from different heads, clubbing of income, Setoff and carry forward of losses and Deductions applicable to an individual.

UNIT I: Income from Capital Gain Capital Gain – Meaning – Short term and Long term Capital Gains – Certain Transactions not included as transfer – Cost of Acquisition – Cost of Improvement
– Indexation – Capital Gain under different circumstances – Exempted Capital Gains – Computation of Capital Gains. Computation of E-Filing methods.

UNIT II: Income from other sources Computation – Grossing up – Deductions in Computing Income under the head and other related provisions.

UNIT III: Clubbing of Incomes and Set off/ Carry forward and Set - Off of losses Clubbing of Incomes under various situations Deemed Incomes Simple Problems on clubbing of incomes – Setoff – Carry forward and set off of losses.

UNIT IV: Deductions from Gross Income Permissible Deductions from Gross Total Income Sec. 80C, 80CCC, 80CCCD, 80D, 80DD, 80DDB, 80E, 80G, 80GG, 80GGA, 80QQB, 80RRB, 80U. Assessment of Individual – Computation of Tax.

UNIT V: Income Tax Authorities and Procedure of Assessment Income Tax Authorities – Powers of the Central Board of Direct Taxes (CBDT), Commissioners of Income Tax and Income Tax officers. Assessment Procedures - Self Assessment and(IRT&TDS)

TEXT BOOKS:

1. Naveen Mittal – Principles of Income Tax Law & Practice – Cengage New Delhi
2. T. Srinivasan – Income Tax & Practice – Vijay Nicole Imprints Private Limited ,

HOD,
Department of Commerce
Ponnaiyah Ramajayam Institute of
Science & Technology (PRIST),
Declared as DEEMED TO BE UNIVERSITY

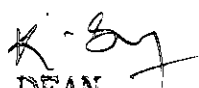
DEAN
School of Commerce and Management
Ponnaiyah Ramajayam Institute of
Science & Technology (PRIST)
P. O. ANJAYAPURAM, CHENNAI - 600 033



**PONNAYAH RAMAJAYAM INSTITUTE OF
SCIENCE & TECHNOLOGY (PRIST)**
Deemed as DEEMED TO BE UNIVERSITY
U/s 3 of UGC Act, 1956



ABOUT UNIVERSITY:

PRIST Deemed to be University, Ponnaiyah Ramajayam Institutions, made a foray into the Academic Domain, with the establishment of Sri Ram Institute of Computer Science and Technology in 1985. Over time, various institutions of higher learning such as Arts and Science College, commerce and business management College of Engineering and Technology, College of Education, Research Institution, Polytechnic college are added feathers to the PRIST crown.

DEPARTMENT OF COMMERCE

The department of commerce and business management was established in the year 2008, with commerce Dept focused on research and education different courses like Undergraduate/Postgraduate/M.Phil and Ph.D programs offered. In this department there are 19 faculty members (Professor, Associate and Assistant Professor The faculty offers B.Com, BBA, M.Com, MBA and research programmers in Accountancy, Finance, Business administration, Banking & Business Economics, Human Resource Management, Marketing Management, Retail Management, Family Business & Entrepreneurship etc.

ADD

ON

COURSES

CERTIFICATION

IN

GST

2023-2024

[Signature]
Department of Commerce
Ponnaiyah Ramajayam Institute of
Science & Technology (PRIST),
Deemed as DEEMED TO BE UNIVERSITY

APPLICATION FORM:

1. FULL NAME _____
2. PROGRAMME _____
3. DISCIPLINE _____
4. INSTITUTION NAME _____
5. DATE-OFBIRTH _____
6. SEX(F/M) _____
7. E-MAIL _____
8. MOBILE NO _____
9. ADDRESS _____

Signature of the Applicant

SUBMISSION OF APPLICATION FORM

Submit your application form in person to the coordinators, school of commerce and Business and Management. PRIST University Thanjavur, vallam,-613403.

**APPLICATION MAY BE SEND TO
COURSE CO-ORDINATOR:**

Dr.K.SATHYA
Head of the department
PRIST University, Thanjavur,
Thanjavur.

[Signature]
DEAN
School of Commerce and Management
Ponnaiyah Ramajayam Institute of
Science & Technology (PRIST)
THANJAVUR

INTRODUCTION

Goods and Services (GST) tax is a "value-added tax" that is exacted upon certain domestically sold goods and services and is typically set by the highest levels of government.

Customers paying a Goods and Services Tax will do so at the point of sale and will find it included within the total cost of the item itself. Sort of like an alternative form of a sales tax.

IMPORTANCE OF GST

Goods and services taxes are eliminated. A competitive market is improved across the markets, transaction costs were reduced. Due to easy tax compliance processes, conducting business improved. Due to the uniformity in tax rates and structures, corporations can make better business decisions and investments.

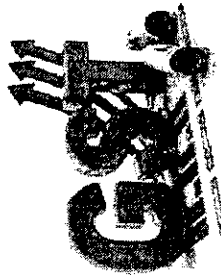

OBJECTIVES OF PROGRAM

This course is designed to enhance the economic literacy and understanding of basic economic concepts. Emphasis is on understanding of core economic principles and how they apply to a wide range of real-world issue. Upon

completion, students can apply economic analysis to evaluate everyday problem.

DURATION OF PROGRAM

45 Hours add on certificate course

PROGRAM OUTCOME

To help the students form a clear idea of Managerial Economics. To enable the students, understand determination of price under different market forms. To understand the situation of competition in a market. To describe the concept of Inflation and its consequences in an economy. To illustrate the calculation of national income.

ELIGIBILITY CRITERIA AND FEE

STRUCTURE

Any graduate shall be eligible for the admission to the course .

CERTIFICATION:

The candidates successfully qualification the course shall be awarded a certificate to that effect in the appropriate form by school of commerce and Business Management, Department of Commerce ,PRIST University ,Thanjavur, Vallam.

G. Sudha
PRIST
Department of Commerce
Ponnaiyah Ramajayam Institute of
Science & Technology (PRIST)
Declared as DEGREE COURSE

K. S. J.
DEAN
School of Commerce and Management
Ponnaiyah Ramajayam Institute of
Science & Technology (PRIST)
THANJAVUR - 613 403.

Course: CERTIFICATE IN GST
Subject Code: 20021GST

AIMS: To emphasis Better performance than the Overall GST

Objectives:

The Goods and Services Tax (GST) in India is to create a unified and simplified tax system, by replacing multiple indirect taxes levied by the central and state governments with a single, comprehensive tax.

OUTCOMES:

From all over study, I concluded that GST has certain positive impacts like; GST will also help to build a transparent and corruption free tax administration. GST also has an optional scheme of lower taxes for small businesses with turnover between INR 20 to 50 lakhs. It is called the composition scheme.

Unit – I

CGST/SGST - Important terms and definitions under Central Goods and Service Tax Act, 2017 and State Goods and Service Tax Act, 2017, Basic of GST, Meaning and scope of supply, Levy and collection of tax.

Unit – II

CGST/ SGST - Time and Value of Supply of goods and / or services, Input Tax Credit, Transitional Provisions, Registration under CGST/SGST Act, Filing of Returns and Assessment, Payment of Tax including Payment of tax on reverse charge basis, Refund under the Act.

Unit – III

CGST/SGST - Maintenance of accounts and Records, Composition scheme, Job work and its procedure, Various Exemption under GST. Demand and recovery under GST, Miscellaneous provisions under GST.

Unit – IV

IGST – Scope of IGST, Important terms and definitions under Integrated Goods and Service Tax Act, 2017, Levy and collection of IGST, Principles for determining the place of supply and Place of supply of goods and services for rated Supply.

Unit – V

Customs – Role of Customs in International Trade, Important Terms & definitions under the Customs Act, 1962; Assessment of Value, Baggage, Bill of entry, Dutiable Goods, Duty Exporter, Foreign going vessel, Air cargo, Goods, Import. Import Manifest; Importer, Prohibited Goods, Shipping Bill, Store, Bill of Lading, Import Manifest, Letter of Credit, Kind of Duties- Basic, auxiliary, additional or counter veiling duties of levy- advalorem specific duties, Prohibition of Export and Import of Goods and Provisions regarding notified & specified goods, Import of Goods- Free Import and Restricted import, types of Import – Import of Cargo, Import of Personal Baggage, Import of Stores.

Suggested readings:

Custom Act 1962 and Rules
Commercial's GST, Commercial law publisher (India) Pvt Ltd, New Delhi.

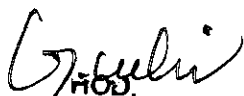
HOD

Department of Commerce
Ponnaiyah Ramajayam Institute of
Science & Technology (PRIST),
Declared as DEEMED TO BE UNIVERSITY

DEAN

School of Commerce and Management
Ponnaiyah Ramajayam Institute of
Science & Technology (PRIST)
THANJAVUR - 613 403.



**PONNAIYAH RAMAJAYAM INSTITUTE OF
SCIENCE & TECHNOLOGY (PRIST)**

Declared as DEEMED TO BE UNIVERSITY
U/o 3 of UGC Act, 1956



ADD-ONCOURSES

EVEN-SEM Certificate Course In Business Process services in Insurance

2023-2024

[Signature]
Department of Commerce
Ponnaiyah Ramajayam Institute of
Science & Technology (PRIST),
Declared as DEEMED TO BE UNIVERSITY

ABOUTUNIVERSITY:

PRIST Deemed to be University, Ponnaiyah Ramajayam Institutions, made a for any into the Academic Domain ,with the establishment of Sri Ram Institute of Computer Science and Technologyin 1985. Over time, various institutionsofhigher learningsuch as Arts and Science College, commerce and business management College of Engineering and Technology, College of Education, Research Institution, Polytechnic college are added feathers to the PRIST crown.

DEPARTMENTOFCOMMERCE

The department of commerce and Business management was established in the year 2008, with commerce Department focused on research and education different courses like Undergraduate/Postgraduate/M.Phil and Ph.D programs offered. In this department there are 19 faculty members (Professor, Associate and Assistant Professor The faculty offers B.Com, BBA, M.Com, MBA and research programmers in Accountancy, Finance, Business administration, Banking & Business Economics, Human Resource Management, Marketing Management, Retail Management, Family Business & Entrepreneurship etc.

APPLICATIONFORM:

1. FULL NAME_____
2. PROGRAMME_____
3. DISCIPLINE_____
4. INSTITUTIONNAME_____
5. DATE-OFBIRTH_____
6. SEX(F/M)_____
7. E-MAIL_____
8. MOBILENO_____
9. ADDRESS_____

Signature of the Applicant

SUBMISSIONOFAPPLICATIONFORM

Submit your application form in person to the coordinators, school of commerce and Business and Management. PRIST Deemed to be University, vallam, Thanjavur - 613403.

APPLICATIONMAYBESENDTO COURSE

CO- ORDINATOR:

Mrs. K.SATHYA,

Dean(i/c) of Commerce and Management

PRIST University, Thanjavur,

[Signature]
DEAN

School of Commerce and Management
Ponnaiyah Ramajayam Institute of
Science & Technology (PRIST)
THANJAVUR - 613 403.



PONNAIYAH RAMAJAYAM INSTITUTE OF SCIENCE & TECHNOLOGY (PRIST)

Declared as DEEMED TO BE UNIVERSITY
U/s 3 of DDC Act 1956

ADD-ONCOURSES

**EVEN-SEM
Certificate Course
In
Business Process services in
Insurance**

2023-2024



Department of Commerce
Ponnaiyah Ramajayam Institute of
Science & Technology (PRIST),
Declared as DEEMED TO BE UNIVERSITY

INTRODUCTION

Business process services in insurance help companies streamline operations and improve customer service by outsourcing non-core tasks to specialized providers.

IMPORTANCE OF BUSINESS PROCESS SERVICES IN INSURANCE:

Insurance BPO enables customized solutions to meet customer needs. BPO services offer high-class service, maintain customer loyalty, and acquire new clients. Moreover, they foster innovation, efficient claims handling, and risk forecasting.

OBJECTIVES OF PROGRAM

BPI allows an organization to run more smoothly by connecting people, processes, and data to reduce manual work and improve efficiency..

DURATION OF PROGRAM

45Hours add on certificate course

PROGRAM OUTCOME

PO1-Business outcomes are the goals of a business.
PO2- They are essentially the reason that a business exists. Business processes are the series of steps used to achieve those goals..

ELIGIBILITY CRITERIA AND FEES STRUCTURE:

Any graduate shall be eligible for the admission to the course.

CERTIFICATION:

The candidates success fully qualification
The course shall be awarded a certificate to that effect in the appropriate form by School of Commerce and Business Management, Department of Commerce, PRIST Deemed to be University, Thanjavur- Vallam.

K. Jay
DEAN

School of Commerce and Management
Ponnaiyah Ramajayam Institute of
Science & Technology (PRIST)
THANJAVUR - 613 403.



PONNAIYAH RAMAJAYAM INSTITUTE OF
SCIENCE & TECHNOLOGY (PRIST)

DECLARED AS DEEMED TO BE UNIVERSITY
BY THE GOVT OF INDIA IN 1988

Academic year: 2023-2024

Certificate Course in Business Process services in Insurance

Course code- 2361BPSI

Aim:

Its aim is to reduce financial uncertainty and make accidental loss manageable

Objectives:

- Develop an understanding of what risk is, how it can be measured and transferred.
- Understand the various Life and Non-Life insurance Concepts. Know about Retirement services provided by the Insurance Companies.

Outcomes:

- Recognize the basic knowledge of Risk and Insurance.
- Classify about the various Insurance
- Policies and underwriting process.
- Understand about the Non-life Insurance.

UNIT-1

Concept of Risk – Basic Concept –Types of Hazard – Characteristics of Insurable Risk –Types of Risks – Risk Management – Fundamental of Insurance – Characteristics of Valid Contract –Principles & practices of Insurance Contract – Key Insurance terminologies History of Insurance –Types of Insurance Companies.

UNIT-2

Concept of Annuity – Types of Annuity – Annuity contract provisions – Annuity: USA – Fixed, Fixed index, Variable – Annuitized pay out option – Annuity benefit payments – open market Individual annuities – principles of Group insurance – Group Life Insurance – Group retirement Plans.

UNIT-3

Concept of Healthcare Insurance – How Healthcare Insurance Works – Key challenges of Healthcare industry - Healthcare Ecosystem – Healthcare regulations & standards; HIPAA - Medicare – Medicaid - Individual health insurance policies – Group Health insurance policies –Different between Individual and Group Insurance - Managed care.

UNIT-4

Concept of Retirement services – Retirement plan – Asset Allocation & Asset Classes – Life Stages of an individual – Defined Benefit & Defined contribution – Individual Retirement Arrangement in USA.

UNIT-5

Concept of Superannuation – Superannuation in India – Superannuation in Australia - Why is Superannuation important – Eligibility for Superannuation - Insurance with superannuation – Beneficiary Nomination.

Department of Commerce
Ponnaiyah Ramajayam Institute of
Science & Technology (PRIST),
Declared as DEEMED TO BE UNIVERSITY

DEAN
School of Commerce and Management
Ponnaiyah Ramajayam Institute of
Science & Technology (PRIST)
THANJAVUR - 613 403.



**PONNAIYAH RAMAJAYAM INSTITUTE OF
SCIENCE & TECHNOLOGY (PRIST)**

Declared as DEEMED TO BE UNIVERSITY
U/s 3 of UGC Act, 1956



**ADD-ONCOURSES
EVEN-SEM
Certificate Course
in
Sales force Business
Administration Specialist**

2023-2024

G. Sathya
HOD.

Department of Commerce
Ponnaiyah Ramajayam Institute of
Science & Technology (PRIST),
Declared as DEEMED TO BE UNIVERSITY

ABOUTUNIVERSITY:

PRIST Deemed to be University, Ponnaiyah Ramajayam Institutions ,made a for any in to the Academic Domain, with the establishment of Sri Ram Institute of Computer Science and Technologyin 1985. Over time, various institution so higher learning such as Arts and Science College, commerce and business management College of Engineering and Technology, College of Education, Research Institution, Polytechnic college are added feathers to the PRIST crown.

DEPARTMENTOFCOMMERCE

The department of commerce and business management was established in the year 2008, with commerce Dept focused on research and educationdifferentcourseslike Undergraduate/Postgraduate/M.Phil and Ph.D programs offered. Inthis department thereare19 faculty members (Professor, Associate and Assistant Professor The faculty offersB.Com, B.Com CA BBA, M.Com, MBA and research programs in Accountancy, Finance, Business administration, Banking & Business Economics, Human ResourceManagement, Marketing Management, Retail Management, Family Business & Entrepreneurship etc.

APPLICATIONFORM:

1. FULL NAME _____
2. PROGRAMME _____
3. DISCIPLINE _____
4. INSTITUTIONNAME _____
5. DATE-OFBIRTH _____
6. SEX(F/M) _____
7. E-MAIL _____
8. MOBILENO _____
9. ADDRESS _____

Signature of the Applicant

SUBMISSIONOFAPPLICATIONFORM

Submit your application form in person to the coordinators, school of commerce and Business and Management. PRIST Deemed to be University Thanjavur, vallam, -613403.

APPLICATIONMAYBESENDTO COURSE

CO- ORDINATOR:
Mrs. K.SATHYA,
Dean(i/c) of Commerce and Management
PRIST University, Thanjavur,

K. Sathya
DEAN

School of Commerce and Management
Ponnaiyah Ramajayam Institute of
Science & Technology (PRIST)
THANJAVUR - 613 403.



PONNAIYAH RAMAJAYAM INSTITUTE OF
SCIENCE & TECHNOLOGY (PRIST)
Declared as DEEMED TO BE UNIVERSITY
U/s 3 of UGC Act 1956.

ADD -ON COURSES

EVEN-SEM

**Certificate Course
in
Sales force Business
Administration Specialist**

2023-2024



[Signature]
HOD.

Department of Commerce
Ponnaiyah Ramajayam Institute of
Science & Technology (PRIST,
Declared as DEEMED TO BE UNIVERSITY

INTRODUCTION

A Sales force Business Administration Specialist, or Sales force Administrator, is a professional who works with stakeholders to customize the Sales force platform to meet business needs.

IMPORTANCE OF SALES FORCE BUSINESS ADMINISTRATION SPECIALIST:

Sales force Administrators enable data-driven decision-making by designing and generating reports and dashboards. They create customized reports to analyze data, track key performance indicators, and provide insights into various aspects of the business.

OBJECTIVES OF PROGRAM

- A good sales force structure is adaptive, efficient, and effective.
- If the sales force structure is adaptive, the company can react quickly to product and market changes without a major structural overhaul.

DURATION OF PROGRAM

45 Hours add on certificate course

PROGRAM OUTCOME

- PO1-Sales force business administration outcomes can be important for a business
- PO2-because they can help improve sales and marketing, customer service, and operational efficiency

ELIGIBILITY CRITERIA AND STRUCTURE

Any graduate shall be eligible for the admission to the course.

CERTIFICATION:

The candidates successfully qualification The course shall be awarded a certificate to that effect in the appropriate form by School of Commerce and Business Management, Department of Commerce, PRIST Deemed to be University, Thanjavur-Vallam.

[Signature]
DEAN

School of Commerce and Management
Ponnaiyah Ramajayam Institute of
Science & Technology (PRIST)
THANJAVUR 613 403.



**PONNAIYAH RAMAJAYAM INSTITUTE OF
SCIENCE & TECHNOLOGY (PRIST)**

DECLARED AS DEEMED TO BE UNIVERSITY
U.A 2 of UGC Act 1956

Academic year: 2023-2024
Certificate Course in Sales force Business Administration Specialist
Course code- 2361SFBA

AIM:

Ensure that businesses and organizations are run effectively, efficiently and profitably.

OBJECTIVES:

- A business aim is the overall long-term target or goal of the business, whereas business
- Objectives are the short-term steps a business needs to take to meet its overall aims.

OUTCOMES:

- People in business administration maintain the flow of a company from the front desk to top Management.
- This includes all elements of business including advertising and marketing, production, Clerical work, finances, budget management, market research and so much more.

UNIT-1

Principles of Management and Organizational Behavior: Develops leadership and interpersonal skills by exploring organizational dynamics and management theories.

UNIT-2

Introduction to Business and Entrepreneurship: Inspires entrepreneurial thinking by guiding learners through the stages of starting and managing a business.

UNIT-3

Skills: Social Media for Entrepreneurs: Teaches effective use of social media platforms to promote businesses and connect with target audiences.

UNIT-4

Marketing and Communications Strategy: Provides tools to craft impactful marketing campaigns and manage brand communication effectively.

UNIT-5

Sales and CRM: Covers effective sales techniques and customer relationship management strategies for business growth.

HOD
Department of Commerce
Ponnaiyah Ramajayam Institute of
Science & Technology (PRIST),
Declared as DEEMED TO BE UNIVERSITY

DEAN
School of Commerce and Management
Ponnaiyah Ramajayam Institute of
Science & Technology (PRIST)
THANJAVUR - 613 403.



PONNAIYAH RAMAJAYAM INSTITUTE OF SCIENCE & TECHNOLOGY (PRIST)

Declared as DEEMED TO-BE UNIVERSITY
U/s 3 of UGC Act, 1956

2023-2024

**STUDNETS ATTENDANCE
DIPLOMA IN EVENT MANAGEMENT**

S.NO	REG.NO	NAME	20/07/2023	21/07/2023	24/07/2023	25/07/2023	26/07/2023	27/07/2023	28/07/2023	31/07/2023
1.	2101CM10101	MANORANJAN K	P	P	P	P	P	P	P	P
2.	2101CM10102	MOHAMED ARSHAD HUSSAIN S	P	P	P	P	P	P	P	P
3.	2101CM10103	MOHAMMED RIYAL M	P	P	P	P	P	P	P	P
4.	2101CM10104	VIJAY K	P	P	P	P	P	P	P	P
5.	2101CM10105	RIYAZ AHAMED J	P	P	P	P	P	P	P	P
6.	2101CM10106	ANANDHA RAMAN R	P	P	P	P	P	P	P	P
7.	2101CM10107	VARUN K	P	P	P	P	P	P	P	P
8.	2101CM10108	MOHAMED AASHIK ISMAIL	P	P	P	P	P	P	P	P
9.	2101CM10109	VIGNESH S	P	P	P	P	P	P	P	P
10	2101CM10110	S.NITHISH KUMAR	P	P	P	P	P	P	P	P
11	2101CM10111	N.NANDHA	P	P	P	P	P	P	P	P
12	2101CM10112	VSIVAHARI	P	P	P	P	P	P	P	P
13	2101CM10113	MUGESHWARAN J	P	A	P	P	P	P	P	P
14	2101CM10114	B.PAVITHRAN	P	P	P	P	P	P	P	P
15	2101CM10115	SARAN KUMAR P	P	P	P	P	P	A	P	P
16	2101CM10116	BOOBALAN K M	P	P	P	P	P	P	P	P
17	2101CM10117	YUVARAJ D	P	P	P	P	P	P	P	P
18	2101CM10118	SAKASH	P	P	P	P	P	P	P	P
19	2101CM10119	PVIGNESH	P	P	P	P	P	P	P	P
20	2101CM10120	PBALAJI	P	P	P	P	P	P	P	P
21	2101CM10122	S.BALA	P	P	P	P	P	P	P	P
22	2101CM10123	E.KOWSIGAN	P	P	P	P	P	P	P	P
23	2101CM10124	RATHISH K R	P	P	P	P	P	P	P	P
24	2101CM10125	HABEEB RAHMAN H	P	P	P	P	P	P	P	P
25	2101CM10126	T S BALAKRISHNA	P	P	P	P	P	P	P	P
26	2101CM10127	J.MAHAR DEEN	P	P	P	P	P	P	P	P
27	2101CM10128	N.VICTOR	P	P	P	P	P	P	P	P
28	2101CM10129	A.MATHANRAJ A	P	P	P	P	P	P	P	P
29	2101CM10130	M.I. MAHAMED IREAN	P	P	P	P	P	P	P	P
30	2101CM10131	K.SIVA	P	P	P	P	P	P	P	P
31	2101CM10132	MOHAMED FARHANS	P	P	P	P	P	P	P	P
32	2101CM10133	S.KARTHIKEYAN	P	P	P	P	P	P	P	P
33	2101CM10134	MEHAMOOD ABU KASIM	P	P	P	P	P	P	P	P
34	2101CM10135	M.DHANANJAYAN	P	P	P	P	P	P	P	P
35	2101CM10136	R.JINIYAVAN	P	P	P	P	P	P	P	P

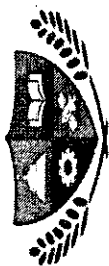

PONNAIYAH RAMAJAYAM INSTITUTE OF SCIENCE & TECHNOLOGY (PRIST)

Declared as DEEMED-TO BE UNIVERSITY
U/s 3 of UGC Act, 1956

36	2101CM10137	Mohamed Nabil j	P																P
37	2101CM10138	J.SRIRAM	P																P
38	2101CM10139	MOHAMED SUHAILA	P																P
39	2101CM10140	N. NABIL	P																P
40	2101CM10141	G.NITHISH KUMAR	P																P
41	2101CM10142	R.JOEMON RAVI	P																P
42	2101CM10143	PSRIKATH	P																P
43	2101CM10144	R.RAVICHANDRAN	P																P
44	2101CM10145	K.MITHRAN	P																P
45	2101CM10146	S.HARIKRISHNAN	P																P
46	2101CM10201	PMIRUDHULA	P																P
47	2101CM10202	S.MADHUBALA	P																P
48	2101CM10203	E.VANATHI	P																P
49	2101CM10204	S.SHALINI	P																P
50	2101CM10205	S.CHITHRA SRI	P																P
51	2101CM10206	K.KAVIYA	P																P
52	2101CM10207	T.HARINI	P																P
53	2101CM10208	INFANT VARSHA G	P																P
54	2101CM10209	R.MEENALOCHINI	P																P
55	2101CM10210	PSUVETHA	P																P
56	2101CM10211	PRIYADHARSHINI S	A																P
57	2101CM10212	PVINOETHINI	P																P
58	2101CM10213	M.YAZHINI	P																P
59	2101CM10214	M.GAYATHRI	P																P
60	2101CM10215	KABIRAMI	P																P

govt. family govt. family govt. family govt. govt.

K. Srinivasan

Department of Commerce
Ponnaiyah Ramajayam Institute of
Science & Technology (PRIST),
Declared as DEEMED TO BE UNIVERSITY

K. Srinivasan
DEAN
School of Commerce and Management
Ponnaiyah Ramajayam Institute of
Science & Technology (PRIST)
THANJAVUR - 613 403.



**PONNAIYAH RAMAJAYAM INSTITUTE OF
SCIENCE & TECHNOLOGY (PRIST)**

Declared as DEEMED-TO-BE UNIVERSITY
U/s 3 of UGC Act, 1956

S.NO	REG.NO	NAME	02/08/2023	03/08/2023	04/08/2023	08/08/2023	09/08/2023	10/08/2023	14/08/2023	18/08/2023
1.	2101CM10101	MANORANJAN K	P	P	P	P	P	P	P	P
2.	2101CM10102	MOHAMED ARSHAD HUSSAIN S	P	P	P	P	P	P	P	P
3.	2101CM10103	MOHAMMED RIYAL M	P	P	P	P	P	P	P	P
4.	2101CM10104	VIJAY K	P	P	P	P	P	P	P	P
5.	2101CM10105	RIYAZ AHAMED J	P	P	P	P	P	P	P	P
6.	2101CM10106	ANANDHA RAMAN R	P	P	P	P	P	P	P	P
7.	2101CM10107	VARUN K	P	P	P	P	P	P	P	P
8.	2101CM10108	MOHAMED AASHIK ISMAIL	P	P	P	P	P	P	P	P
9.	2101CM10109	VIGNESH S	P	P	P	P	P	P	P	P
10.	2101CM10110	S.NITHISH KUMAR	P	P	P	P	P	P	P	P
11.	2101CM10111	N.NANDHA	P	P	P	P	P	P	P	P
12.	2101CM10112	V.SIVAHARI	P	P	P	P	P	P	P	P
13.	2101CM10113	MUGESHWARAN J	P	A	P	P	P	P	P	P
14.	2101CM10114	B.PAVITHRAN	P	P	P	P	P	P	P	P
15.	2101CM10115	SARAN KUMAR P	P	P	P	P	P	P	P	P
16.	2101CM10116	BOOBALAN K M	P	P	P	P	P	P	P	P
17.	2101CM10117	YUVARAJ D	P	P	P	P	P	P	P	P
18.	2101CM10118	S.AKASH	P	P	P	P	P	P	P	P
19.	2101CM10119	P.VIGNESH	P	P	P	P	P	P	P	P
20.	2101CM10120	PBALAJI	P	P	P	P	P	P	P	P
21.	2101CM10122	S.BALA	P	P	P	P	P	P	P	P
22.	2101CM10123	E.KOWSIGAN	P	P	P	P	P	P	P	P
23.	2101CM10124	RATHISH KR	P	P	P	P	P	P	P	P
24.	2101CM10125	HABEEB RAHMAN H	P	P	P	P	P	P	P	P
25.	2101CM10126	T S BALAKRISHNA	P	P	P	P	P	P	P	P
26.	2101CM10127	J.MAHAR DEEN	P	P	P	P	P	P	P	P
27.	2101CM10128	N.VICTOR	P	P	P	P	P	P	P	P
28.	2101CM10129	A.MATHANRAJ A	P	P	P	P	P	P	P	P
29.	2101CM10130	M.I. MAHAMED IRFAN	P	P	P	P	P	P	P	P
30.	2101CM10131	KSIVA	P	P	P	P	P	P	P	P
31.	2101CM10132	MOHAMED FARTHANS	P	P	P	P	P	P	P	P
32.	2101CM10133	S.KARTHIKEYAN	P	P	P	P	P	P	P	P
33.	2101CM10134	MEHAMOOD ABU KASIM	P	P	P	P	P	P	P	P



**PONNAIYAH RAMAJAYAM INSTITUTE OF
SCIENCE & TECHNOLOGY (PRIST)**

Declared as DEEMED TO BE UNIVERSITY
U/s 3 of UGC Act, 1956

34.	2101CM10135	M.DHANANJAYAN	P	P	P	P	P	P	P	P	P	P	P	P	P
35.	2101CM10136	R.INIYAVAN	P	P	P	P	P	P	P	P	P	P	P	P	P
36.	2101CM10137	Mohamed Nabil j	P	P	P	P	P	P	P	P	P	P	P	P	P
37.	2101CM10138	JSRIRAM	P	P	P	P	P	P	P	P	P	P	P	P	P
38.	2101CM10139	MOHAMED SUHAILA	P	P	P	P	P	P	P	P	P	P	P	P	P
39.	2101CM10140	N. NABIL	P	P	P	P	P	P	P	P	P	P	P	P	P
40.	2101CM10141	G.NITHISH KUMAR	P	P	P	P	P	P	P	P	P	P	P	P	P
41.	2101CM10142	RJOEMON RAVI	P	P	P	P	P	P	P	P	P	P	P	P	P
42.	2101CM10143	PSRIKATH	P	P	P	P	P	P	P	P	P	P	P	P	P
43.	2101CM10144	R.RAVICHANDRAN	P	P	P	P	P	P	P	P	P	P	P	P	P
44.	2101CM10145	K.MITHRAN	P	P	P	P	P	P	P	P	P	P	P	P	P
45.	2101CM10146	S.SHARIKRISHNAN	P	P	P	P	P	P	P	P	P	P	P	P	P
46.	2101CM10201	PMIRUDHULA	P	P	P	P	P	P	P	P	P	P	P	P	P
47.	2101CM10202	S.MADHUBALA	P	P	P	P	P	P	P	P	P	P	P	P	P
48.	2101CM10203	E.VANATHI	P	P	P	P	P	P	P	P	P	P	P	P	P
49.	2101CM10204	S.SHALINI	P	P	P	P	P	P	P	P	P	P	P	P	P
50.	2101CM10205	S.CHITHRA SRI	P	P	P	P	P	P	P	P	P	P	P	P	P
51.	2101CM10206	K.KAVIYA	P	P	P	P	P	P	P	P	P	P	P	P	P
52.	2101CM10207	T.HARINI	P	P	P	P	P	P	P	P	P	P	P	P	P
53.	2101CM10208	INFANT VARSHA G	P	P	P	P	P	P	P	P	P	P	P	P	P
54.	2101CM10209	R.MEENALOCINI	P	P	P	P	P	P	P	P	P	P	P	P	P
55.	2101CM10210	P.SUVETHA	P	P	P	P	P	P	P	P	P	P	P	P	P
56.	2101CM10211	PRIYADHARSHINI S	A	P	P	P	P	P	P	P	P	P	P	P	P
57.	2101CM10212	P.VINOTHINI	P	P	P	P	P	P	P	P	A	P	P	P	P
58.	2101CM10213	M.YAZHINI	P	P	P	P	P	P	P	P	P	P	P	P	P
59.	2101CM10214	M.GAYATHRI	P	P	P	P	P	P	P	P	P	P	P	P	P
60.	2101CM10215	KABIRAMI	P	P	P	P	P	P	P	P	P	P	P	P	P

Smt. Senthilamma
Smt. Jeyanthi
Smt. Jayanthi
Smt. Jeyanthi
Smt. Jeyanthi
Smt. Jeyanthi
Smt. Jeyanthi
Smt. Jeyanthi
Smt. Jeyanthi
Smt. Jeyanthi
Smt. Jeyanthi
Smt. Jeyanthi
Smt. Jeyanthi
Smt. Jeyanthi
Smt. Jeyanthi
Smt. Jeyanthi

(Signature)

Department of Commerce
Ponnaiyah/Ramajayam Institute of
Science & Technology (PRIST)
Declared as DEEMED TO BE UNIVERSITY

(Signature)
DEAN
School of Commerce and Management
Ponnaiyah Ramajayam Institute of
Science & Technology (PRIST)
THANJAVUR - 613 403.



PONNAIYAH RAMAJAYAM INSTITUTE OF SCIENCE & TECHNOLOGY (PRIST)

Declared as DEEMED TO BE UNIVERSITY
U/s 3 of UGC Act, 1956

S.NO	REG.NO	NAME	21/08/2023	22/08/2023	04/09/2023	05/09/2023	06/09/2023	08/09/2023	12/09/2023	14/09/2023
1.	2101CM10101	MANORANJAN K	P	P	P	P	P	P	P	P
2.	2101CM10102	MOHAMED ARSHAD HUSSAIN S	P	P	P	P	P	P	P	P
3.	2101CM10103	MOHAMMED RIVAL M	P	P	P	P	P	P	P	P
4.	2101CM10104	VIJAY K	P	P	P	P	P	P	P	P
5.	2101CM10105	RIVAZ AHAMED J	P	P	P	P	P	P	P	P
6.	2101CM10106	ANANDHA RAMAN R	P	P	P	P	P	P	P	P
7.	2101CM10107	VARUN K	P	P	P	P	P	P	P	P
8.	2101CM10108	MOHAMED AASHIK ISMAIL	P	P	P	P	P	P	P	P
9.	2101CM10109	VIGNESH S	P	P	P	P	P	P	P	P
10.	2101CM10110	S.NITHISH KUMAR	P	P	P	P	P	P	P	P
11.	2101CM10111	N.NANDHA	P	P	P	P	P	P	P	P
12.	2101CM10112	V.SIVAHARI	P	P	P	P	P	P	P	P
13.	2101CM10113	MUGESHWARAN J	P	P	P	P	P	P	P	P
14.	2101CM10114	B.PAVITHRAN	P	P	P	P	P	P	P	P
15.	2101CM10115	SARAN KUMAR P	P	P	P	P	P	P	P	P
16.	2101CM10116	BOOBALAN K M	P	P	P	P	P	P	P	P
17.	2101CM10117	YUVARAJ D	P	P	P	P	P	P	P	P
18.	2101CM10118	SAKASH	P	P	P	P	P	P	P	P
19.	2101CM10119	PVIGNESH	P	P	P	P	P	P	P	P
20.	2101CM10120	PBALAJI	P	P	P	P	P	P	P	P
21.	2101CM10122	S.BALA	P	P	P	P	P	P	P	P
22.	2101CM10123	E.KOWSIGAN	P	P	P	P	P	P	P	P
23.	2101CM10124	RATHISH K R	P	P	P	P	P	P	P	P
24.	2101CM10125	HABEEB RAHMAN H	P	P	P	P	P	P	P	P
25.	2101CM10126	T S BALAKRISHNA	P	P	P	P	P	P	P	P
26.	2101CM10127	J.MAHAR DEEN	P	P	P	P	P	P	P	P
27.	2101CM10128	N.VICTOR	P	P	P	P	P	P	P	P
28.	2101CM10129	A.MATHANRAJ A	P	P	P	P	P	P	P	P
29.	2101CM10130	M.I. MAHAMED IRFAN	P	P	P	P	P	P	P	P
30.	2101CM10131	K.SIVA	P	P	P	P	P	P	P	P
31.	2101CM10132	MOHAMED FARHANS	P	P	P	P	P	P	P	P
32.	2101CM10133	S.KARTHIKEYAN	P	P	P	P	P	P	P	P
33.	2101CM10134	MEHAMOOD ABU KASIM	P	P	P	P	P	P	P	P
34.	2101CM10135	M.DHANANJAYAN	P	P	P	P	P	P	P	P
35.	2101CM10136	R.INIYAVAN	P	P	P	P	P	P	P	P
36.	2101CM10137	Mohamed Nabil j	P	P	P	P	P	P	P	P



**PONNAIYAH RAMAJAYAM INSTITUTE OF
SCIENCE & TECHNOLOGY (PRIST)**

Declared as DEEMED TO BE UNIVERSITY
U/s 3 of UGC Act, 1956

37.	2101CM10138	J.SRRAM	P	P	P	P	P	P	P	P	P	P	P
38.	2101CM10139	MOHAMED SUHAIL A	P	P	P	P	P	P	P	P	P	P	P
39.	2101CM10140	N. NABIL	P	P	P	P	P	P	P	P	P	P	P
40.	2101CM10141	G.NITHISH KUMAR	P	P	P	P	P	P	P	P	P	P	P
41.	2101CM10142	R.JOEMON RAVI	P	P	P	P	P	P	P	P	P	P	P
42.	2101CM10143	PSRIKATH	P	P	P	P	P	P	P	P	P	P	P
43.	2101CM10144	R.RAVICHANDRAN	P	P	P	P	P	P	P	P	P	P	P
44.	2101CM10145	K.MITHRAN	P	P	P	P	A	P	P	P	P	P	P
45.	2101CM10146	S.HARIKRISHNAN	P	P	P	P	P	P	P	P	P	P	P
46.	2101CM10201	P.MIRUDHULA	P	P	P	P	P	P	P	P	P	P	P
47.	2101CM10202	S.MADHUBALA	P	A	P	P	P	P	P	P	P	P	P
48.	2101CM10203	E.VANATHI	P	P	P	P	P	P	P	P	P	P	P
49.	2101CM10204	S.SHALINI	P	P	P	P	P	P	P	P	P	P	P
50.	2101CM10205	S.CHITHRA SRI	P	P	P	P	P	P	P	P	P	P	P
51.	2101CM10206	K.KAVIYA	P	P	P	P	P	P	P	P	P	P	A
52.	2101CM10207	T.HARINI	P	P	P	P	P	P	P	P	P	P	A
53.	2101CM10208	INFANT VARSHA G	P	P	P	P	P	P	P	P	P	P	P
54.	2101CM10209	R.MEENALOCHINI	P	P	P	P	P	P	P	P	P	P	P
55.	2101CM10210	PSUVETHA	P	P	P	P	P	P	P	P	P	P	P
56.	2101CM10211	PRIVADHARSHINI S	A	P	P	P	P	P	P	P	P	P	P
57.	2101CM10212	PVINOETHINI	P	P	P	P	P	A	P	P	P	P	P
58.	2101CM10213	M.VAZHINI	P	P	P	P	P	P	P	P	P	P	P
59.	2101CM10214	M.GAYATHRI	P	P	P	P	P	P	P	P	P	P	P
60.	2101CM10215	K.ABIRAMI	P	P	P	P	P	P	P	P	P	P	P

Prof. T. Arinibag of Prof. S. Sankar Ganesh. Tamilnadu Govt. University

S. Sankar Ganesh
MOO.

Department of Commerce
**Ponnaiyah Ramajayam Institute of
Science & Technology (PRIST)**
Declared as DEEMED TO BE UNIVERSITY

K. Sankar Ganesh
DEAN
School of Commerce and Management
Ponnaiyah Ramajayam Institute of
Science & Technology (PRIST)
THANJAVUR-613 403.



**PONNAIYAH RAMAJAYAM INSTITUTE OF
SCIENCE & TECHNOLOGY (PRIST)**

Declared as DEEMED TO BE UNIVERSITY
U/s 3 of UGC Act, 1956

S.NO	REG.NO	NAME	18/09/2023	20/09/2023	21/09/2023	25/09/2023	27/09/2023	05/10/2023	10/10/2023	11/10/2023
1.	2101CM10101	MANORANJAN K	P	P	P	P	P	P	P	P
2.	2101CM10102	MOHAMED ARSHAD HUSSAIN S	P	P	P	P	P	P	P	P
3.	2101CM10103	MOHAMMED RIYAL M	P	P	P	P	P	P	P	P
4.	2101CM10104	VIJAY K	P	P	P	P	P	P	P	P
5.	2101CM10105	RIYAZ AHAMED J	P	P	P	P	P	P	P	P
6.	2101CM10106	ANANDHA RAMAN R	P	P	P	P	P	P	P	P
7.	2101CM10107	VARUN K	P	P	P	P	P	P	P	P
8.	2101CM10108	MOHAMED AASHIK ISMAL	P	P	P	P	P	P	P	P
9.	2101CM10109	VIGNESH S	P	P	P	P	P	P	P	P
10.	2101CM10110	S.NITHISH KUMAR	P	P	P	P	P	P	P	P
11.	2101CM10111	N.NANDHA	P	P	P	P	P	P	P	P
12.	2101CM10112	VSIHARI	P	P	P	P	P	P	P	P
13.	2101CM10113	MUGESHWARAN J	P	P	P	P	P	P	P	P
14.	2101CM10114	B.PAVITHRAN	P	P	P	P	P	P	P	P
15.	2101CM10115	SARAN KUMAR P	P	P	P	P	P	P	P	P
16.	2101CM10116	BOOBALAN K M	P	P	P	P	P	P	P	P
17.	2101CM10117	YUVARAJ D	P	P	P	P	P	P	P	P
18.	2101CM10118	SAKASH	P	P	P	P	P	P	P	P
19.	2101CM10119	PVIGNESH	P	P	P	P	P	P	P	P
20.	2101CM10120	PBALAJI	P	P	P	P	P	P	P	P
21.	2101CM10122	S.BALA	P	P	P	P	P	P	P	P
22.	2101CM10123	E.KOWSIGAN	P	P	P	P	P	P	P	P
23.	2101CM10124	RATHISH KR	P	P	P	P	P	P	P	P
24.	2101CM10125	HABEEB RAHMAN H	P	P	P	P	P	P	P	P
25.	2101CM10126	T S BALAKRISHNA	P	P	P	P	P	P	P	P
26.	2101CM10127	J.MAHAR DEEN	P	P	P	P	P	P	P	P
27.	2101CM10128	N.VICTOR	P	P	P	P	P	P	P	P
28.	2101CM10129	A.MATHANRAJ A	P	P	P	P	P	P	P	P
29.	2101CM10130	M.I. MAHAMED IRFAN	P	P	P	P	P	P	P	P
30.	2101CM10131	K.SIVA	P	P	P	P	P	P	P	P
31.	2101CM10132	MOHAMED FARHANS	P	P	P	P	P	P	P	P
32.	2101CM10133	S.KARTHIKEYAN	P	P	P	P	P	P	P	P



**PONNAIYAH RAMAJAYAM INSTITUTE OF
SCIENCE & TECHNOLOGY (PRIST)**

Declared as DEEMED TO BE UNIVERSITY
U/s 3 of UGC Act, 1956

33.	2101CM10134	MEHAMOOD ABU KASIM	P	P	P	P	P	P	P	P	P	P	P	P	P	P	P
34.	2101CM10135	M.DHANANJAYAN	P	P	P	P	P	P	P	P	P	P	P	P	P	P	P
35.	2101CM10136	R.INIYAVAN	P	P	P	P	P	P	P	P	P	P	P	P	P	P	P
36.	2101CM10137	Mohamed Nabil j	P	P	P	P	P	P	P	P	P	P	P	P	P	P	P
37.	2101CM10138	J.SRIRAM	P	P	P	P	P	P	P	P	P	P	P	P	P	P	P
38.	2101CM10139	MOHAMED SUHAIL A	P	P	P	P	P	P	P	P	P	P	P	P	P	P	P
39.	2101CM10140	N. NABIL	P	P	P	P	P	P	P	P	P	P	P	P	P	P	P
40.	2101CM10141	G.NITHISH KUMAR	P	P	P	P	P	P	P	P	P	P	P	P	P	P	P
41.	2101CM10142	R.JOEMON RAVI	P	P	P	P	P	P	P	P	P	P	P	P	P	P	P
42.	2101CM10143	PSRIKATH	P	P	P	P	P	P	P	P	P	P	P	P	P	P	P
43.	2101CM10144	R.RAVICHANDRAN	P	P	P	P	P	P	P	P	P	P	P	P	P	P	P
44.	2101CM10145	K.MITHRAN	P	P	P	P	P	P	P	P	P	P	P	P	P	P	P
45.	2101CM10146	S.HARIKRISHNAN	P	P	P	P	P	P	P	P	P	P	P	P	P	P	P
46.	2101CM10201	PMIRUDHULA	P	P	P	P	P	P	P	P	P	P	P	P	P	P	P
47.	2101CM10202	S.MADHUBALA	P	P	P	P	P	P	P	P	P	P	P	P	P	P	P
48.	2101CM10203	E.VANATHI	P	P	P	P	P	P	P	P	P	P	P	P	P	P	P
49.	2101CM10204	S.SHALINI	P	P	P	P	P	P	P	P	P	P	P	P	P	P	P
50.	2101CM10205	S.CHITHRA SRI	P	P	P	P	P	P	P	P	P	P	P	P	P	P	P
51.	2101CM10206	K.KAVIYA	P	P	P	P	P	P	P	P	P	P	P	P	P	P	P
52.	2101CM10207	T.HARINI	P	P	P	P	P	P	P	P	P	P	P	P	P	P	P
53.	2101CM10208	INFANT VARSHA G	P	P	P	P	P	P	P	P	P	P	P	P	P	P	P
54.	2101CM10209	R.MEENALOCHINI	P	P	P	P	P	P	P	P	P	P	P	P	P	P	P
55.	2101CM10210	PSUVETHA	P	P	P	P	P	P	P	P	P	P	P	P	P	P	P
56.	2101CM10211	PRIYADHARSHINI S	A	P	P	P	P	P	P	P	P	P	P	P	P	P	P
57.	2101CM10212	PVINOETHINI	P	P	P	P	P	P	P	P	P	P	P	P	P	P	P
58.	2101CM10213	M.YAZHINI	P	P	P	P	P	P	P	P	P	P	P	P	P	P	P
59.	2101CM10214	M.GAYATHRI	P	P	P	P	P	P	P	P	P	P	P	P	P	P	P
60.	2101CM10215	K.ABIRAMI	P	P	P	P	P	P	P	P	P	P	P	P	P	P	P

Handwritten notes:
2101CM10134 - P
2101CM10135 - P
2101CM10136 - P
2101CM10137 - P
2101CM10138 - P
2101CM10139 - P
2101CM10140 - P
2101CM10141 - P
2101CM10142 - P
2101CM10143 - P
2101CM10144 - P
2101CM10145 - P
2101CM10146 - P
2101CM10201 - P
2101CM10202 - P
2101CM10203 - P
2101CM10204 - P
2101CM10205 - P
2101CM10206 - P
2101CM10207 - P
2101CM10208 - P
2101CM10209 - P
2101CM10210 - P
2101CM10211 - P
2101CM10212 - P
2101CM10213 - P
2101CM10214 - P
2101CM10215 - P

Handwritten signature:
K. S. S.

Department of Commerce
Ponnaiyah Ramajayam Institute of
Science & Technology (PRIST),
Declared as DEEMED TO BE UNIVERSITY

School of Commerce and Management
Ponnaiyah Ramajayam Institute of
Science & Technology (PRIST)
HANJAVUR - 613 403.



**PONNAIYAH RAMAJAYAM INSTITUTE OF
SCIENCE & TECHNOLOGY (PRIST)**

Declared as DEFEMED TO BE UNIVERSITY
U/s 3 of UGC Act, 1956

S.NO	REG.NO	NAME	12/10/2023	16/10/2023	17/10.2023	18/10/2023	19/10/2023	20/10/2023	06/11/2023	07/11/2023
1.	2101CM10101	MANORANJAN K	P	P	P	P	P	P	P	P
2.	2101CM10102	MOHAMED ARSHAD HUSSAIN S	P	P	P	P	P	P	P	P
3.	2101CM10103	MOHAMMED RIYAL M	P	P	P	P	P	P	P	P
4.	2101CM10104	VIJAY K	P	P	P	P	P	P	P	P
5.	2101CM10105	RIYAZ AHAMED J	P	P	P	P	P	P	P	P
6.	2101CM10106	ANANDHA RAMAN R	P	P	P	P	P	P	P	P
7.	2101CM10107	VARUN K	P	P	P	P	P	P	P	P
8.	2101CM10108	MOHAMED AASHIK ISMAIL	P	P	P	P	P	P	P	P
9.	2101CM10109	VIGNESH S	P	P	P	P	P	P	P	P
10.	2101CM10110	S.NITHISH KUMAR	P	P	P	P	P	P	P	P
11.	2101CM10111	N.NANDHA	P	P	P	P	P	P	P	P
12.	2101CM10112	V.SIVAHARI	P	P	P	P	P	P	P	P
13.	2101CM10113	MUGESHWARAN J	P	P	P	P	P	P	P	P
14.	2101CM10114	B.PAVITHRAN	P	P	P	P	P	P	P	P
15.	2101CM10115	SARAN KUMAR P	P	P	P	P	P	P	P	P
16.	2101CM10116	BOOBALAN K M	P	P	P	P	P	P	P	P
17.	2101CM10117	YUVARAJ D	P	P	P	P	P	P	P	P
18.	2101CM10118	SAKASH	P	P	P	P	P	P	P	P
19.	2101CM10119	PVIGNESH	P	P	P	P	P	P	P	P
20.	2101CM10120	PBALAJI	P	P	P	P	P	P	P	P
21.	2101CM10122	S.BALA	P	P	P	P	P	P	P	P
22.	2101CM10123	E.KOWSIGAN	P	P	P	P	P	P	P	P
23.	2101CM10124	RATHISH K R	P	P	P	P	P	P	P	P
24.	2101CM10125	HABEEB RAHMAN H	P	P	P	P	P	P	P	P
25.	2101CM10126	T S BALAKRISHNA	P	P	P	P	P	P	P	P
26.	2101CM10127	J.MAHAR DEEN	P	P	P	P	P	P	P	P
27.	2101CM10128	N.VICTOR	P	P	P	P	P	P	P	P
28.	2101CM10129	A.MATHANRAJ A	P	P	P	P	P	P	P	P
29.	2101CM10130	M.I. MAHAMED IRFAN	P	P	P	P	P	P	P	P
30.	2101CM10131	K.SIVA	P	P	P	P	P	P	P	P



PONNAIYAH RAMAJAYAM INSTITUTE OF SCIENCE & TECHNOLOGY (PRIST)

Declared as DEFEMED TO BE UNIVERSITY
U/s 3 of UGC Act, 1956

S.NO	REG.NO	NAME	12/12/2023	13/12/2023	14/12/2023	15/12/2023	18/12/2023
1.	2101CM10101	MANORANJAN K	P	P	P	P	P
2.	2101CM10102	MOHAMED ARSHAD HUSSAIN S	P	P	P	P	P
3.	2101CM10103	MOHAMMED RIYAL M	P	P	P	P	P
4.	2101CM10104	VIJAY K	P	P	P	P	P
5.	2101CM10105	RIYAZ AHAMED J	P	P	P	P	P
6.	2101CM10106	ANANDHA RAMAN R	P	P	P	P	P
7.	2101CM10107	VARUN K	P	P	P	P	P
8.	2101CM10108	MOHAMED AASHIK ISMAIL	P	P	P	P	P
9.	2101CM10109	VIGNESH S	P	P	P	P	P
10.	2101CM10110	S.NITHISH KUMAR	P	P	P	P	P
11.	2101CM10111	N.NANDHA	P	P	P	P	P
12.	2101CM10112	V.SIVAHARI	P	P	P	P	P
13.	2101CM10113	MUGESHWARAN J	P	P	P	P	P
14.	2101CM10114	B.PAVITHRAN	P	P	P	P	P
15.	2101CM10115	SARAN KUMAR P	P	P	P	P	P
16.	2101CM10116	BOOBALAN K M	P	P	P	P	P
17.	2101CM10117	YUVARAJ D	P	P	P	P	P
18.	2101CM10118	SAKASH	P	P	P	P	P
19.	2101CM10119	P.VIGNESH	P	P	P	P	P
20.	2101CM10120	PBALAJI	P	P	P	P	P
21.	2101CM10122	S.BALA	P	P	P	P	P
22.	2101CM10123	E.KOWSIGAN	P	P	P	P	P
23.	2101CM10124	RATHISH KR	P	P	P	P	P
24.	2101CM10125	HABEEB RAHMAN H	P	P	P	P	P
25.	2101CM10126	T S BALAKRISHNA	P	P	P	P	P
26.	2101CM10127	J.MAHAR DEEN	P	P	P	P	P
27.	2101CM10128	N.VICTOR	P	P	P	P	P
28.	2101CM10129	A.MATHANRAJ A	P	P	P	P	P
29.	2101CM10130	M.I. MAHAMED IRFAN	P	P	P	P	P
30.	2101CM10131	K.SIVA	P	P	P	P	P



PONNAIYAH RAMAJAYAM INSTITUTE OF SCIENCE & TECHNOLOGY (PRIST)

Declared as DEEMED TO BE UNIVERSITY
U/s 3 of UGC Act, 1956

31.	2101CM10132	MOHAMED FARHANS	P	P	P	P	P
32.	2101CM10133	S.KARTHIKEYAN	P	P	P	P	P
33.		MEHAMOOD ABU KASIM	P	P	P	P	P
34.	2101CM10134	M.DHANANJAYAN	P	P	P	P	P
35.	2101CM10135	R.INIYAVAN	P	P	P	P	P
36.	2101CM10136	Mohamed Nabil j	P	P	P	P	P
37.	2101CM10137	J.SRIRAM	P	P	P	P	P
38.			P	P	P	P	P
39.	2101CM10139	MOHAMED SUHAIL A	P	P	P	P	P
40.	2101CM10140	N. NABIL	P	P	P	P	P
			P	P	P	P	P
	2101CM10141	G.NITHISH KUMAR	P	P	P	P	P
41.	2101CM10142	R.JOEMON RAVI	P	P	P	P	P
42.	2101CM10143	P.SRIKATH	P	P	P	P	P
43.	2101CM10144	R.RAVICHANDRAN	P	P	P	P	P
44.	2101CM10145	K.MITHRAN	P	P	P	P	P
45.	2101CM10146	S.SHARIKRISHNAN	P	P	P	P	P
46.	2101CM10201	P.MIRUDHULA	P	P	P	P	P
47.	2101CM10202	S.MADHUBALA	P	P	P	P	P
48.	2101CM10203	E.VANATHI	P	P	P	P	P
49.	2101CM10204	S.SHALINI	P	P	P	P	P
50.	2101CM10205	S.CHITHRA SRI	P	P	P	P	P
51.	2101CM10206	K.KAVIYA	P	P	P	P	P
52.	2101CM10207	T.HARINI	P	P	P	P	P
53.	2101CM10208	INFANT VARSHA G	P	P	P	P	P
54.	2101CM10209	R.MEENALOCHINI	P	P	P	P	P
55.	2101CM10210	PSUVETHA	P	P	P	P	P
56.			P	P	P	P	P
	2101CM10211	PRİYADHARSHINIS	A	P	P	P	P
57.	2101CM10212	P.VINOTHINI	P	P	P	P	P
58.	2101CM10213	M.YAZHINI	P	P	P	P	A
59.	2101CM10214	M.GAYATHRI	P	P	P	P	P
60.	2101CM10215	K.ABIRAMI	P	P	P	P	P

J.A. Tamilraj Jant
K. Jant
DEAN

School of Commerce and Management
Ponnaiyah Ramajayam Institute of
Science & Technology (PRIST)
THANJAVUR - 613 403.

(Signature)
Department of Commerce
Ponnaiyah Ramajayam Institute of
Science & Technology (PRIST),
Declared as DEEMED TO BE UNIVERSITY



**PONNAIYAH RAMAJAYAM INSTITUTE OF
SCIENCE & TECHNOLOGY (PRIST)**

Declared as DEEMED TO BE UNIVERSITY
U/s 3 of UGC Act, 1956

**ODD SEMESTER
CERTIFICATE COURSE IN INTELLECTUAL PROPERTY RIGHTS**

S.NO	REG.NO	NAME	17/07/2023	18/07/2023	19/07/2023	20/07/2023	21/07/2023	25/07/2023	26/07/2023	28/07/2023
1.	2101AP10101	ASHOK V	P	P	P	P	P	P	P	P
2.	2101AP10102	S.GOPINATH	P	P	P	P	P	P	P	P
3.	2101AP10103	SUDHARASAN R	P	P	P	P	P	P	P	P
4.	2101AP10104	NITHISH KUMAR I	P	P	P	P	P	P	P	P
5.	2101AP10105	SHIVAPRASAD S	P	P	P	P	P	P	P	P
6.	2101AP10106	ARUN KUMAR M	P	P	P	P	P	P	P	P
7.	2101AP10107	KISHORE KUMAR K	P	P	P	P	P	P	P	P
8.	2101AP10108	PONNAR S	P	P	P	P	P	P	P	P
9.	2101AP10109	SANTHOSH S	P	P	P	P	P	P	P	P
10.	2101AP10110	SANTHOSH S	P	P	P	P	P	P	P	P
11.	2101AP10111	H.MOHAMED THOUFIK ANSAR	P	P	P	P	P	P	P	P
12.	2101AP10112	S.SETHUPATHI	P	P	P	P	P	P	P	P
13.	2101AP10113	R.DHINAGAR	P	A	P	P	P	P	P	P
14.	2101AP10114	KV.KISHORE	P	P	P	P	P	P	P	P
15.	2101AP10115	M.DHANUSH	P	P	P	P	P	A	P	P
16.	2101AP10116	KARAN KUMAR R	P	P	P	P	P	P	P	P
17.	2101AP10117	BARATHI MOHAN B	P	P	P	P	P	P	P	P
18.	2101AP10118	V M HASSIM HANEEF	P	P	P	P	P	P	P	P
19.	2101AP10119	SANJAY KUMAR G	P	P	P	P	P	P	P	P
20.	2101AP10120	R.KUDIYARASU	P	P	P	P	P	P	P	P
21.	2101AP10121	DHARANI DHARAN S	P	P	P	P	P	P	P	P
22.	2101AP10122	S.YOGA KARTHIK RAJ	P	P	P	P	P	P	P	P
23.	2101AP10124	K.RAJ GANESH	P	P	P	P	P	P	P	P
24.	2101AP10125	M.NAGATHARSHAN	P	P	P	P	P	P	P	P
25.	2101AP10126	L.GNANESH	P	P	P	P	P	P	P	P
26.	2101AP10127	MUJAVITH J	P	P	P	P	P	P	P	P
27.	2101AP10128	ANBU SURYA J	P	P	P	P	P	P	P	P
28.	2101AP10129	SATHYA NARAYANAN G	P	P	P	P	P	P	P	P
29.	2101AP10130	M.SUKUMAR	P	P	P	P	P	P	P	P
30.	2101AP10131	V.KEERTHIVASAN	P	P	P	P	P	P	P	P



PONNAIYAH RAMAJAYAM INSTITUTE OF SCIENCE & TECHNOLOGY (PRIST)

Declared as DEFINED-TO-BE UNIVERSITY
U/s 3 of UGC Act, 1956

S.NO	REG.NO	NAME	31/07/2023	01/08/2023	03/08/2023	04/08/2023	08/08/2023	09/08/2023	10/08/2023	14/08/2023
1.	2101AP10101	ASHOK V	P	P	P	P	P	P	P	P
2.	2101AP10102	S.GOPINATH	P	P	P	P	P	P	P	P
3.	2101AP10103	SUDHARASAN R	P	P	P	P	P	P	P	P
4.	2101AP10104	NITHISH KUMAR I	P	P	P	P	P	P	P	P
5.	2101AP10105	SHIVAPRASAD S	P	P	P	P	P	P	P	P
6.	2101AP10106	ARUN KUMAR M	P	P	P	P	P	P	P	P
7.	2101AP10107	KISHORE KUMAR K	P	P	P	P	P	P	P	P
8.	2101AP10108	PONNAR S	P	P	P	P	P	P	P	P
9.	2101AP10109	SANTHOSH S	P	P	P	P	P	P	P	P
10.	2101AP10110	SANTHOSH S	P	P	P	P	P	P	P	P
11.	2101AP10111	H.MOHAMED THOUFIK ANSAR	P	P	P	P	P	P	P	P
12.	2101AP10112	S.SETHUPATHI	P	P	P	P	P	P	P	P
13.	2101AP10113	R.DHINAGAR	P	A	P	P	P	P	P	P
14.	2101AP10114	KV.KISHORE	P	P	P	P	P	P	P	P
15.	2101AP10115	M.DHANUSH	P	P	P	P	P	P	P	P
16.	2101AP10116	KARAN KUMAR R	P	P	P	P	P	A	P	P
17.	2101AP10117	BARATHI MOHAN B	P	P	P	P	P	P	P	P
18.	2101AP10118	V.M HASSIM HANEEF	P	P	P	P	P	P	P	P
19.	2101AP10119	SANJAY KUMAR G	P	P	P	P	P	P	P	P
20.	2101AP10120	R.KUDIYARASU	P	P	P	P	P	P	P	P
21.	2101AP10121	DHARANI DHARAN S	P	P	P	P	P	P	P	P
22.	2101AP10122	S.YOGA KARTHIK RAJ	P	P	P	P	P	P	P	P
23.	2101AP10124	KRAJ GANESH	P	P	P	P	P	P	P	P
24.	2101AP10125	M.NAGATHARSHAN	P	P	P	P	P	P	P	P
25.	2101AP10126	L.GNANESH	P	P	P	P	P	P	P	P
26.	2101AP10127	MUJAVITH J	P	P	P	P	P	P	P	P
27.	2101AP10128	ANBU SURYA J	P	P	P	P	P	P	P	P
28.	2101AP10129	SATHYA NARAYANAN G	P	P	P	P	P	P	P	P
29.	2101AP10130	M.SUKUMAR	P	P	P	P	P	P	P	P
30.	2101AP10131	V.KEERTHIVASAN	P	P	P	P	P	P	P	P
31.	2101AP10132	M.KUMARAN	P	P	P	P	P	P	P	P
32.	2101AP10133	G.KARUN	P	P	P	P	P	P	P	P

Handwritten signatures and dates:
 31/07/2023: [Signature]
 01/08/2023: [Signature]
 03/08/2023: [Signature]
 04/08/2023: [Signature]
 08/08/2023: [Signature]
 09/08/2023: [Signature]
 10/08/2023: [Signature]
 14/08/2023: [Signature]



**PONNAIYAH RAMAJAYAM INSTITUTE OF
SCIENCE & TECHNOLOGY (PRIST)**

Declared as DEEMED-TO-BE-UNIVERSITY
U/s 3 of UGC Act, 1956

33.	2101AP10134	K.SUGABALAN	P	P	P	P	P	P	P	P	P	P	P	P	P	P	P	P	P	P	P
34.	2101AP10135	GERAGE BONI BOSE R	P	P	P	P	P	P	P	P	P	P	P	P	P	P	P	P	P	P	P
35.	2101AP10136	ANBUS	P	P	P	P	P	P	P	P	P	P	P	P	P	P	P	P	P	P	P
36.	2101AP10137	BALAMURUGAN.N	P	P	P	P	P	P	P	P	P	P	P	P	P	P	P	P	P	P	P
37.	2101AP10138	DANIEL PRABAKAR.P	P	P	P	P	P	P	P	P	P	P	P	P	P	P	P	P	P	P	P
38.	2101AP10139	GOKUL.M	P	P	P	P	P	P	P	P	P	P	P	P	P	P	P	P	P	P	P
39.	2101AP10201	JANANI.V	P	P	P	P	P	P	P	P	P	P	P	P	P	P	P	P	P	P	P
40.	2101AP10202	DHIVYASREE.G	P	P	P	P	P	P	P	P	P	P	P	P	P	P	P	P	P	P	P
41.	2101AP10203	LAVANYA.M	P	P	P	P	P	P	P	P	P	P	P	P	P	P	P	P	P	P	P
42.	2101AP10204	VARSHINI.S	P	P	P	P	P	P	P	P	P	P	P	P	P	P	P	P	P	P	P
43.	2101AP10205	SHANMUGAPRIYA.G	P	P	P	P	P	P	P	P	P	P	P	P	P	P	P	P	P	P	P
44.	2101AP10206	R.NIVETHA	P	P	P	P	P	P	P	P	P	P	P	P	P	P	P	P	P	P	P
45.	2101AP10207	JAYANANDHINI.M	P	P	P	P	P	P	P	P	P	P	P	P	P	P	P	P	P	P	P
46.	2101AP10208	SRI.RANJANI.D	P	P	P	P	P	P	P	P	P	P	P	P	P	P	P	P	P	P	P
47.	2101AP10209	RAKALYA	P	P	P	P	P	P	P	P	P	P	P	P	P	P	P	P	P	P	P
48.	2101AP10210	A.EMMIMAL	P	P	P	P	P	P	P	P	P	P	P	P	P	P	P	P	P	P	P
49.	2101AP10211	NAFILA.BEGUM.A	P	P	P	P	P	P	P	P	P	P	P	P	P	P	P	P	P	P	P
50.	2101AP10212	E.KUZHALI	P	P	P	P	P	P	P	P	P	P	P	P	P	P	P	P	P	P	P
51.	2101AP10213	M.BARANIKKA	P	P	P	P	P	P	P	P	P	P	P	P	P	P	P	P	P	P	P
52.	2101AP10214	M.R.ANIS.FATHIMA	P	P	P	P	P	P	P	P	P	P	P	P	P	P	P	P	P	P	P
53.	2101AP10215	M.DEVIPRIYA	P	P	P	P	P	P	P	P	P	P	P	P	P	P	P	P	P	P	P
54.	2101AP10216	S.DHARSHINI	P	P	P	P	P	P	P	P	P	P	P	P	P	P	P	P	P	P	P
55.	2101AP10217	NAISHWARYA	P	P	P	P	P	P	P	P	P	P	P	P	P	P	P	P	P	P	P
56.	2101AP10218	R.SHANALAKSHMI	A	P	P	P	P	P	P	P	P	P	P	P	P	P	P	P	P	P	P
57.	2101AP10219	V.DHIVYA	P	P	P	P	P	P	P	P	P	P	P	P	P	P	P	P	P	P	P
58.	2101AP10220	T.HEMALATHA	P	P	P	P	P	P	P	P	P	P	P	P	P	P	P	P	P	P	P
59.	2101AP10222	S.MOHANAPRIYA	P	P	P	P	P	P	P	P	P	P	P	P	P	P	P	P	P	P	P
60.	2101AP10221	J.MADHUMITHA	P	P	P	P	P	P	P	P	P	P	P	P	P	P	P	P	P	P	P

G. Nishu
Dean

Department of Commerce
Ponnaiyah Ramajayam Institute of
Science & Technology (PRIST),
Declared as DEEMED TO BE UNIVERSITY

G. Nishu
Dean

School of Commerce and Management
Ponnaiyah Ramajayam Institute of
Science & Technology (PRIST)
THANJAVUR - 613 403

Prabha
Prabha

G. Nishu
G. Nishu



PONNAIYAH RAMAJAYAM INSTITUTE OF SCIENCE & TECHNOLOGY (PRIST)

Declared as DEEMED-TO-BE UNIVERSITY
U/s 3 of UGC Act, 1956

S.NO	REG.NO	NAME	16/08/2023	17/08/2023	18/08/2023	07/09/2023	08/09/2023	12/09/2023	13/09/2023
1.	2101AP10101	ASHOK V	P	P	P	P	P	P	P
2.	2101AP10102	SGOPINATH	P	P	P	P	P	P	P
3.	2101AP10103	SUDHARASAN R	P	P	P	P	P	P	P
4.	2101AP10104	NITHISH KUMARI	P	P	P	P	P	P	P
5.	2101AP10105	SHIVAPRASAD S	P	P	P	P	P	P	P
6.	2101AP10106	ARUN KUMAR M	P	P	P	P	P	P	P
7.	2101AP10107	KISHORE KUMAR K	P	P	P	P	P	P	P
8.	2101AP10108	PONNAR S	P	P	P	P	P	P	P
9.	2101AP10109	SANTHOSH S	P	P	P	P	P	P	P
10.	2101AP10110	SANTHOSH S	P	P	P	P	P	P	P
11.	2101AP10111	H.MOHAMED THOUFIK ANSAR	P	P	P	P	P	P	P
12.	2101AP10112	S.SETHUPATHI	P	P	P	P	P	P	P
13.	2101AP10113	R.DHINAGAR	P	A	P	P	P	P	P
14.	2101AP10114	KV. KISHORE	P	P	P	P	P	P	P
15.	2101AP10115	M.DHANUSH	P	P	P	P	P	A	P
16.	2101AP10116	KARAN KUMAR R	P	P	P	P	P	P	P
17.	2101AP10117	BARATHI MOHAN B	P	P	P	P	P	P	P
18.	2101AP10118	V M HASSIM HANEEF	P	P	P	P	P	P	P
19.	2101AP10119	SANJAY KUMAR G	P	P	P	P	P	P	P
20.	2101AP10120	R.KUDIYARASU	P	P	P	P	P	P	P
21.	2101AP10121	DHARANI DHARAN S	P	P	P	P	P	P	P
22.	2101AP10122	S.YOGA KARTHIK RAJ	P	P	P	P	P	P	P
23.	2101AP10124	K.RAJ GANESH	P	P	P	P	P	P	P
24.	2101AP10125	M.NAGATHARSHAN	P	P	P	P	P	P	P
25.	2101AP10126	L.GNANESH	P	P	P	P	P	P	P
26.	2101AP10127	MUJAVITH J	P	P	P	P	P	P	P
27.	2101AP10128	ANBU SURYA J	P	P	P	P	P	P	P
28.	2101AP10129	SATHYA NARAYANAN G	P	P	P	P	P	P	P
29.	2101AP10130	M.SUKUMAR	P	P	P	P	P	P	P
30.	2101AP10131	VKEERTHIVASAN	P	P	P	P	P	P	P
31.	2101AP10132	M.KUMARAN	P	P	P	P	P	P	P
32.	2101AP10133	G.KARUN	P	P	P	P	P	P	P
33.	2101AP10134	K.SUGABALAN	P	P	P	P	P	P	P
34.	2101AP10135	GERAGE BONI BOSE R	P	P	P	P	P	P	P
35.	2101AP10136	ANBUS	P	P	P	P	P	P	P
36.	2101AP10137	BALAMURUGAN.N	P	P	P	P	P	P	P

Handwritten signatures and dates:
 16/08/2023: [Signature]
 17/08/2023: [Signature]
 18/08/2023: [Signature]
 07/09/2023: [Signature]
 08/09/2023: [Signature]
 12/09/2023: [Signature]
 13/09/2023: [Signature]



PONNAIYAH RAMAJAYAM INSTITUTE OF SCIENCE & TECHNOLOGY (PRIST)

Declared as DEEMED TO BE UNIVERSITY
U/s 3 of UGC Act. 1956

37.	2101AP10138	DANIEL PRABAKAR P	P					P		P		P	P
38.	2101AP10139	GOKUL M	P					P		P		P	P
39.	2101AP10201	JANANI V	P					P		P		P	P
40.	2101AP10202	DHIVYASREE G	P					P		P		P	P
41.	2101AP10203	LAVANYA M	P					P		P		P	P
42.	2101AP10204	VARSHINI S	P					P		P		P	P
43.	2101AP10205	SHANMUGAPRIYA G	P					P		P		P	P
44.	2101AP10206	R.NIVETHA	P					P		A		P	P
45.	2101AP10207	JAYANANDHINI M	P					P		P		P	P
46.	2101AP10208	SRI RANJANI D	P					P		P		P	P
47.	2101AP10209	R.KALIYA	P					A		P		P	P
48.	2101AP10210	A.EMMIMAL	P					P		P		P	P
49.	2101AP10211	NAFILA BEGUM A	P					P		P		P	P
50.	2101AP10212	E.KUZHALI	P					P		P		P	P
51.	2101AP10213	M.BARANAIKA	P					P		P		P	P
52.	2101AP10214	M R ANIS FATHIMA	P					P		P		P	P
53.	2101AP10215	M.DEVIPRIYA	P					P		P		P	P
54.	2101AP10216	S.DHARSHINI	P					P		P		P	P
55.	2101AP10217	NAISHWARYA	P					P		P		P	P
56.	2101AP10218	R.SHANALAKSHMI	A					P		P		P	P
57.	2101AP10219	VDHIVYA	P					P		P		A	P
58.	2101AP10220	THEMALATHA	P					P		P		P	P
59.	2101AP10222	S.MOHANAPRIYA	P					P		P		P	P
60.	2101AP10221	J.MADHUMITHA	P					P		P		P	P

Prof. G. Vaidyanathan
G. Vaidyanathan
Prof. G. Vaidyanathan

G. Vaidyanathan
Department of Commerce
Ponnaiyah Ramajayam Institute of
Science & Technology (PRIST)
Declared as DEEMED TO BE UNIVERSITY

K. S.
DEAN
School of Commerce and Management
Ponnaiyah Ramajayam Institute of
Science & Technology (PRIST)
TANJAVUR-613 403.



PONNAIYAH RAMAJAYAM INSTITUTE OF SCIENCE & TECHNOLOGY (PRIST)

Declared as DEEMED TO BE UNIVERSITY
U/s 3 of UGC Act, 1956

CERTIFICATE COURSE IN MUTUAL FUND OPERATIONS

S.NO	REG.NO	NAME	17/07/2023	18/07/2023	19/07/2023	20/07/2023	21/07/2023	25/07/2023	26/07/2023	28/07/2023
1.	2201CM10101	SANJAL.G	P	P	P	P	P	P	P	P
2.	2201CM10102	JAYASURYA.R	P	P	P	P	P	P	P	P
3.	2201CM10103	ARAVIND.V	P	P	P	P	P	P	P	P
4.	2201CM10104	MAGESHWARAN.M	P	P	P	P	P	P	P	P
5.	2201CM10105	AJAY.J	P	P	P	P	P	P	P	P
6.	2201CM10106	VIMAL.V	P	P	P	P	P	P	P	P
7.	2201CM10107	KAVIYA.S	P	P	P	P	P	P	P	P
8.	2201CM10108	SHANMUGA PRIYA.S	P	P	P	P	P	P	P	P
9.	2201CM10109	MURUGANANDAN.M	P	P	P	P	P	P	P	P
10.	2201CM10110	PRASANTH.M	P	P	P	P	P	P	P	P
11.	2201CM10111	RAJESHKUMAR.S	P	P	P	P	P	P	P	P
12.	2201CM10112	AJEETH.S	P	P	P	P	P	P	P	P
13.	2201CM10201	S.MALINI	P	A	P	P	P	P	P	P
14.	2201CM10202	ANANDHI.S	P	P	P	P	P	P	P	P
15.	2201CM10203	BUVANA.D	P	P	P	P	P	P	P	P
16.	2201CM10204	EZHILARASI.M	P	P	P	P	P	A	P	P
17.	2201CM10205	-SARA.N	P	P	P	P	P	P	P	P
18.	2201CM10206	SANTHIS	P	P	P	P	P	P	P	P
19.	2201CM10207	ADILAXMI.M	P	P	P	P	P	P	P	P
20.	2201CM10208	ARULSELVIA	P	P	P	P	P	P	P	P
21.	2201CM10209	ASHARANI.M	P	P	P	P	P	P	P	P
22.	2201CM10210	BEULAH JOYLE.X	P	P	P	P	P	P	P	P
23.		CHRISTINAL MARY.N	P	P	P	P	P	P	P	P
24.	2201CM10211	MARY.N								
25.	2201CM10212	DHIVYA.A	P	P	P	P	P	P	P	P
26.	2201CM10213	GLORIA.L	P	P	P	P	P	P	P	P
27.	2201CM10214	HEMAVATHI.M	P	P	P	P	P	P	P	P
28.	2201CM10215	JAYAKARTHIGAI	P	P	P	P	P	P	P	P
29.	2201CM10216	JOTHILASKHMI.R	P	P	P	P	P	P	P	P
30.	2201CM10217	KOTHAINAYAKI.S	P	P	P	P	P	P	P	P
31.	2201CM10218	MAHESWARI.A	P	P	P	P	P	P	P	P
32.	2201CM10219	MEENATCHI.P	P	P	P	P	P	P	P	P
33.	2201CM10220	NEELAMARY.V	P	P	P	P	P	P	P	P
34.	2201CM10221	NITHIYAN	P	P	P	P	P	P	P	P
35.	2201CM10222	PAVITHRA.A	P	P	P	P	P	P	P	P
	2201CM10223	POOJA.M	P	P	P	P	P	P	P	P



PONNAIYAH RAMAJAYAM INSTITUTE OF SCIENCE & TECHNOLOGY (PRIST)

Declared as DEEMED-TO-BE-UNIVERSITY
U/s 3 of UGC Act, 1956

S.NO	REG.NO	NAME	31/07/2023	01/08/2023	03/08/2023	04/08/2023	08/08/2023	09/08/2023	10/08/2023	14/08/2023
1.	2201CM10101	SANJALG	P	P	P	P	P	P	P	P
2.	2201CM10102	JAYASURYA.R	P	P	P	P	P	P	P	P
3.	2201CM10103	ARAVIND.V	P	P	P	P	P	P	P	P
4.	2201CM10104	MAGESHWARAN.M	P	P	P	P	P	P	P	P
5.	2201CM10105	AJAY.J	P	P	P	P	P	P	P	P
6.	2201CM10106	VIMAL.V	P	P	P	P	P	P	P	P
7.	2201CM10107	KAVIYA.S	P	P	P	P	P	P	P	P
8.	2201CM10108	SHANMUGA PRIYAS	P	P	P	P	P	P	P	P
9.	2201CM10109	MURUGANANDAN.M	P	P	P	P	P	P	P	P
10.	2201CM10110	PRASANTH.M	P	P	P	P	P	P	P	P
11.	2201CM10111	RAJESHKUMAR.S	P	P	P	P	P	P	P	P
12.	2201CM10112	AJEETH.S	P	P	P	P	P	P	P	P
13.	2201CM10201	S.MALINI	P	A	P	P	P	P	P	P
14.	2201CM10202	ANANDHI.S	P	P	P	P	P	P	P	P
15.	2201CM10203	BUVANA.D	P	P	P	P	P	P	P	P
16.	2201CM10204	EZHILARASI.M	P	P	P	P	P	A	P	P
17.	2201CM10205	SARA.N	P	P	P	P	P	P	P	P
18.	2201CM10206	SANTHIS	P	P	P	P	P	P	P	P
19.	2201CM10207	ADILAXMI.M	P	P	P	P	P	P	P	P
20.	2201CM10208	ARULSEIVIA	P	P	P	P	P	P	P	P
21.	2201CM10209	ASHARANI.M	P	P	P	P	P	P	P	P
22.	2201CM10210	BEULAH JOYLEX	P	P	P	P	P	P	P	P
23.		CHRISTINAL	P	P	P	P	P	P	P	P
	2201CM10211	MARY.N								
24.	2201CM10212	DHIVYA.A	P	P	P	P	P	P	P	P
25.	2201CM10213	GLORIAL	P	P	P	P	P	P	P	P
26.	2201CM10214	HEMAVATHI.M	P	P	P	P	P	P	P	P
27.	2201CM10215	JAYAKARTHIGAJ	P	P	P	P	P	P	P	P
28.	2201CM10216	JOTHILASKSHMI.R	P	P	P	P	P	P	P	P
29.	2201CM10217	KOTHAINAYAKI.S	P	P	P	P	P	P	P	P
30.	2201CM10218	MAHESWARLA	P	P	P	P	P	P	P	P
31.	2201CM10219	MEENATCHI.P	P	P	P	P	P	P	P	P
32.	2201CM10220	NEELAMARY.V	P	P	P	P	P	P	P	P
33.	2201CM10221	NITHIYA.N	P	P	P	P	P	P	P	P
34.	2201CM10222	PAVITHRA.A	P	P	P	P	P	P	P	P
35.	2201CM10223	POOJA.M	P	P	P	P	P	P	P	P
36.	2201CM10224	RAJALAKSHMI.R	P	P	P	P	P	P	P	P
37.	2201CM10225	RAJESWARI.D	P	P	P	P	P	P	P	P

Signature of G. V. Subramanian
Signature of G. V. Subramanian
Signature of G. V. Subramanian



PONNAIYAH RAMAJAYAM INSTITUTE OF SCIENCE & TECHNOLOGY (PRIST)

Declared as DEEMED-TO-BE-UNIVERSITY
U/s 3 of UGC Act, 1956

38.	2201CM10226	SASIKAL.A.C	P	P	P	P	P	P	P	P	P	P	P	P	P	P	P	P	P	P	P	P	P	P	P	P	P	
39.	2201CM10227	SHALINIK	P	P	P	P	P	P	P	P	P	P	P	P	P	P	P	P	P	P	P	P	P	P	P	P	P	P
40.	2201CM10228	SHARMILADEVI.H	P	P	P	P	P	P	P	P	P	P	P	P	P	P	P	P	P	P	P	P	P	P	P	P	P	P
41.	2201CM10229	SIVARANJINI.M	P	P	P	P	P	P	P	P	P	P	P	P	P	P	P	P	P	P	P	P	P	P	P	P	P	P
42.	2201CM10230	SUBASREE.G	P	P	P	P	P	P	P	P	P	P	P	P	P	P	P	P	P	P	P	P	P	P	P	P	P	P
43.	2201CM10231	SUMITHRAG	P	P	P	P	P	P	P	P	P	P	P	P	P	P	P	P	P	P	P	P	P	P	P	P	P	P
44.	2201CM10232	THAMIZHARASID	P	P	P	P	P	P	P	P	P	P	P	P	P	P	P	P	P	P	P	P	P	P	P	P	P	P
45.	2201CM10233	VIJAYALAKSHMI.P	P	P	P	P	P	P	P	P	P	P	P	P	P	P	P	P	P	P	P	P	P	P	P	P	P	P
46.	2201CM10234	AJAYA.J	P	P	P	P	P	P	P	P	P	P	P	P	P	P	P	P	P	P	P	P	P	P	P	P	P	P
47.	2201CM10235	VIMALAV	P	P	P	P	P	P	P	P	P	P	P	P	P	P	P	P	P	P	P	P	P	P	P	P	P	P
48.	2201CM10236	KAVIYA.S	P	P	P	P	P	P	P	P	P	P	P	P	P	P	P	P	P	P	P	P	P	P	P	P	P	P
49.	2201CM10237	SHANMUGA PRIYAS	P	P	P	P	P	P	P	P	P	P	P	P	P	P	P	P	P	P	P	P	P	P	P	P	P	P
50.	2201CM10238	DHIVYA.G	P	P	P	P	P	P	P	P	P	P	P	P	P	P	P	P	P	P	P	P	P	P	P	P	P	P
51.	2201CM10239	DEEPAK.A	P	P	P	P	P	P	P	P	P	P	P	P	P	P	P	P	P	P	P	P	P	P	P	P	P	P
52.	2201CM10240	ARUNA.A	P	P	P	P	P	P	P	P	P	P	P	P	P	P	P	P	P	P	P	P	P	P	P	P	P	P
53.	2201CM10241	AARTHIB	P	P	P	P	P	P	P	P	P	P	P	P	P	P	P	P	P	P	P	P	P	P	P	P	P	P
54.	2201CM10242	CHARUMATHIK	P	P	P	P	P	P	P	P	P	P	P	P	P	P	P	P	P	P	P	P	P	P	P	P	P	P
55.	2201CM10244	LALITHAS	P	P	P	P	P	P	P	P	P	P	P	P	P	P	P	P	P	P	P	P	P	P	P	P	P	P
56.	2201CM10245	KANNIGAJ	A	P	P	P	P	P	P	P	P	P	P	P	P	P	P	P	P	P	P	P	P	P	P	P	P	P
57.	2201CM10246	MAHALAKSHMIS	P	P	P	P	P	P	P	P	P	P	P	P	P	P	P	P	P	P	P	P	P	P	P	P	P	P
58.	2201CM10248	NIVETHA.K	P	P	P	P	P	P	P	P	P	P	P	P	P	P	P	P	P	P	P	P	P	P	P	P	P	P
59.	2201CM10249	JAYALAKSHMIG	P	P	P	P	P	P	P	P	P	P	P	P	P	P	P	P	P	P	P	P	P	P	P	P	P	P
60.	2201CM10250	VINOTHINIL	P	P	P	P	P	P	P	P	P	P	P	P	P	P	P	P	P	P	P	P	P	P	P	P	P	P

Dr. S. Srinivasan Dean, Department of Commerce, Ponnaiyiah Ramajayam Institute of Science & Technology (PRIST)

S. Srinivasan
Department of Commerce
Ponnaiyiah Ramajayam Institute of
Science & Technology (PRIST),
Declared as DEEMED TO BE UNIVERSITY

S. Srinivasan
DEAN
School of Commerce and Management
Ponnaiyiah Ramajayam Institute of
Science & Technology (PRIST)
THANJAVUR - 613 403.



PONNAIYAH RAMAJAYAM INSTITUTE OF SCIENCE & TECHNOLOGY (PRIST)

Declared as DEEMED-TO-BE-UNIVERSITY
U/s 3 of UGC Act, 1956

S.NO	REG.NO	NAME	16/08/2023	17/08/2023	18/08/2023	07/09/2023	08/09/2023	12/09/2023	13/09/2023
1.	2201CM10101	SANJAI.G	P	P	P	P	P	P	P
2.	2201CM10102	JAYASURYA.R	P	P	P	P	P	P	P
3.	2201CM10103	ARAVIND.V	P	P	P	P	P	P	P
4.	2201CM10104	MAGESHWARAN.M	P	P	P	P	P	P	P
5.	2201CM10105	AJAY.J	P	P	P	P	P	P	P
6.	2201CM10106	VIMAL.V	P	P	P	P	P	P	P
7.	2201CM10107	KAVIYA.S	P	P	P	P	P	P	P
8.	2201CM10108	SHANMUGA PRIYA.S	P	P	P	P	P	P	P
9.	2201CM10109	MURUGANANDAN.M	P	P	P	P	P	P	P
10.	2201CM10110	PRASANTH.M	P	P	P	P	P	P	P
11.	2201CM10111	RAJESHKUMAR.S	P	P	P	P	P	P	P
12.	2201CM10112	AJEETH.S	P	P	P	P	P	P	P
13.	2201CM10201	S.MALINI	P	P	P	P	P	P	P
14.	2201CM10202	ANANDHI.S	P	P	P	P	P	P	P
15.	2201CM10203	BUVANA.D	P	P	P	P	P	P	P
16.	2201CM10204	EZHILARASI.M	P	P	P	P	P	P	P
17.	2201CM10205	SARA.N	P	P	P	P	P	P	P
18.	2201CM10206	SANTHI.S	P	P	P	P	P	P	P
19.	2201CM10207	ADILAXMI.M	P	P	P	P	P	P	P
20.	2201CM10208	ARULSELVIA	P	P	P	P	P	P	P
21.	2201CM10209	ASHARANIM	P	P	P	P	P	P	P
22.	2201CM10210	BEULAH JOYLEX	P	P	P	P	P	P	P
23.	2201CM10211	CHRISTINAL MARY.N	P	P	P	P	P	P	P
24.	2201CM10212	DHIVYA.A	P	P	P	P	P	P	P
25.	2201CM10213	GLORIA.L	P	P	P	P	P	P	P
26.	2201CM10214	HEMAVATHI.M	P	P	P	P	P	P	P
27.	2201CM10215	JAYAKARTHIGAI	P	P	P	P	P	P	P
28.	2201CM10216	JOTHILAKSHMIR	P	P	P	P	P	P	P
29.	2201CM10217	KOTHAINAYAKIS	P	P	P	P	P	P	P
30.	2201CM10218	MAHESWARLA	P	P	P	P	P	P	P
31.	2201CM10219	MEENATCHI.P	P	P	P	P	P	P	P
32.	2201CM10220	NEELAMARY.V	P	P	P	P	P	P	P
33.	2201CM10221	NITHIYA.N	P	P	P	P	P	P	P
34.	2201CM10222	PAVITHRA.A	P	P	P	P	P	P	P
35.	2201CM10223	POOJA.M	P	P	P	P	P	P	P
36.	2201CM10224	RAJALAKSHMIR	P	P	P	P	P	P	P
37.	2201CM10225	RAJESWARI.D	P	P	P	P	P	P	P
38.	2201CM10226	SASIKALAC	P	P	P	P	P	P	P

Signature of J. Lakshmi
Signature of J. Lakshmi
Signature of J. Lakshmi
Signature of J. Lakshmi



PONNAIYAH RAMAJAYAM INSTITUTE OF SCIENCE & TECHNOLOGY (PRIST)

Declared as DEEMED TO BE UNIVERSITY
U/s 3 of UGC Act, 1956

39.	2201CM10227	SHALINI.K	P	P	P	P	P	P	P	P	P	P	P
40.	2201CM10228	SHARMILADEVI.H	P	P	P	P	P	P	P	P	P	P	P
41.	2201CM10229	SIVARANJINI.M	P	P	P	P	P	P	P	P	P	P	P
42.	2201CM10230	SUBASREE.G	P	P	P	P	P	P	P	P	P	P	P
43.	2201CM10231	SUMITHRA.G	P	P	P	P	P	P	P	P	P	P	P
44.	2201CM10232	THAMIZHARASI.D	P	P	P	P	P	A	P	P	P	P	P
45.	2201CM10233	VIJAYALAKSHMI.P	P	P	P	P	P	P	P	P	P	P	P
46.	2201CM10234	AJAYA.J	P	P	P	P	P	P	P	P	P	P	P
47.	2201CM10235	VIMALA.V	P	A	P	P	P	P	P	P	P	P	P
48.	2201CM10236	KAVIYA.S	P	P	P	P	P	P	P	P	P	P	P
49.	2201CM10237	SHANMUGA PRIYA.S	P	P	P	P	P	P	P	P	P	P	P
50.	2201CM10238	DHIVYA.G	P	P	P	P	P	P	P	P	P	P	P
51.	2201CM10239	DEEPAK.A	P	P	P	P	P	P	P	P	P	P	P
52.	2201CM10240	ARUNA.A	P	P	P	P	P	P	P	P	P	P	P
53.	2201CM10241	AARTHI.B	P	P	P	P	P	P	P	P	P	P	P
54.	2201CM10242	CHARUMATHI.K	P	P	P	P	P	P	P	P	P	P	P
55.	2201CM10244	LALITHA.S	P	P	P	P	P	P	P	P	P	P	P
56.	2201CM10245	KANNIGA.J	A	P	P	P	P	P	P	P	P	P	P
57.	2201CM10246	MAHALAKSHMI.S	P	P	P	P	P	P	A	P	P	P	P
58.	2201CM10248	NIVETHA.K	P	P	P	P	P	P	P	P	P	P	P
59.	2201CM10249	JAYALAKSHMI.G	P	P	P	P	P	P	P	P	P	P	P
60.	2201CM10250	VINOTHINI.L	P	P	P	P	P	P	P	P	P	P	P



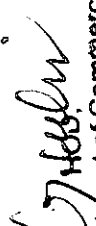

 Department of Commerce
 Ponnaiyah Ramajayam Institute of
 Science & Technology (PRIST)
 Declared as DEEMED TO BE UNIVERSITY

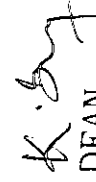
 DEAN
 School of Commerce and Management
 Ponnaiyah Ramajayam Institute of
 Science & Technology (PRIST)
 THANJAVUR - 613 403.



**PONNAIYAH RAMAJAYAM INSTITUTE OF
SCIENCE & TECHNOLOGY (PRIST)**

Declared as DEEMED TO-BE UNIVERSITY
U/s 3 of UGC Act, 1956

CERTIFICATE COURSE IN E-FILING OF INCOME TAX (IRT&TDS)

S.NO	REG.NO	NAME	17/07/2023	18/07/2023	19/07/2023	20/07/2023	21/07/2023	25/07/2023	26/07/2023	28/07/2023
1.	2201AP10101	SHAMSHAN.L	P	P	P	P	P	P	P	P
2.	2201AP10102	DEEPAK.A	P	P	P	P	P	P	P	P
3.	2201AP10103	ARUNA	P	P	P	P	P	P	P	P
4.	2201AP10104	DHANUSH.G	P	P	P	P	P	P	P	P
5.	2201AP10105	RAGULA	P	P	P	P	P	P	P	P
6.	2201AP10106	HADAR ALIH	P	P	P	P	P	P	P	P
7.	2201AP10107	IYAPPAN.A	P	P	P	P	P	P	P	P
8.	2201AP10108	GOKUL.SP	P	P	P	P	P	P	P	P
9.	2201AP10109	NARESH.V	P	P	P	P	P	P	P	P
10.		MOHAMED	P	P	P	P	P	P	P	P
	2201AP10110	ARSHATH ALL.M								
11.	2201AP10111	PRAGADEESH.R	P	P	P	P	P	P	P	P
12.	2201AP10112	HARI GANESH.R	P	P	P	P	P	P	P	P
13.	2201AP10113	KARTIKEYAN.M	P	A	P	P	P	P	P	P
14.	2201AP10114	RAJESH.R	P	P	P	P	P	P	P	P
15.	2201AP10115	AJAYR	P	P	P	P	P	A	P	P
16.	2201AP10116	RAMESHR	P	P	P	P	P	P	P	P
17.	2201AP10117	NAGENDRA	P	P	P	P	P	P	P	P
		KUMAR.R								
18.	2201AP10118	HARISH KANAK.K	P	P	P	P	P	P	P	P
19.		MOHAMED	P	P	P	P	P	P	P	P
	2201AP10119	RIVAS.S								
20.	2201AP10201	GIRIYON RAJ.R	P	P	P	P	P	P	P	P
21.	2201AP10202	GOKUL RAM.N	P	P	P	P	P	P	P	P
22.	2201AP10203	MEENATCHI.K	P	P	P	P	P	P	P	P
23.	2201AP10204	GAJAPRIYA.D	P	P	P	P	P	P	P	P
24.	2201AP10205	VIJAYALAKSHMIS	P	P	P	P	P	P	P	P
25.	2201AP10206	SRI SARVA.S	P	P	P	P	P	P	P	P
26.	2201AP10207	GUNA MARY.G	P	P	P	P	P	P	P	P
27.	2201AP10208	AARTHYR	P	P	P	P	P	P	P	P
28.	2201AP10209	MONIKA.A	P	P	P	P	P	P	P	P
29.	2201AP10210	SWATHI.S	P	P	P	P	P	P	P	P
30.	2201AP10211	PAVITHRA.A	P	P	P	P	P	P	P	P
31.	2201AP10212	POOJA.M	P	P	P	P	P	P	P	P
32.	2201AP10213	RAJALAKSHMIR	P	P	P	P	P	P	P	P
33.	2201AP10214	RAJESWARID	P	P	P	P	P	P	P	P



**PONNAIYAH RAMAJAYAM INSTITUTE OF
SCIENCE & TECHNOLOGY (PRIST)**

Declared as DEEMED-TO-BE-UNIVERSITY
U/s 3 of UGC Act, 1956

S.NO	REG.NO	NAME	31/07/2023	01/08/2023	03/08/2023	04/08/2023	08/08/2023	09/08/2023	10/08/2023	14/08/2023
1.	2201AP10101	SHAMSHAN.L	P	P	P	P	P	P	P	P
2.	2201AP10102	DEEPAK.A	P	P	P	P	P	P	P	P
3.	2201AP10103	ARUN.A	P	P	P	P	P	P	P	P
4.	2201AP10104	DHANUSH.G	P	P	P	P	P	P	P	P
5.	2201AP10105	RAGUL.A	P	P	P	P	P	P	P	P
6.	2201AP10106	HADARALI.H	P	P	P	P	P	P	P	P
7.	2201AP10107	IYYAPPAN.A	P	P	P	P	P	P	P	P
8.	2201AP10108	GOKUL.SP	P	P	P	P	P	P	P	P
9.	2201AP10109	NARESH.V	P	P	P	P	P	P	P	P
10.	2201AP10110	MOHAMED ARSHATH.ALI.M	P	P	P	P	P	P	P	P
11.	2201AP10111	PRAGADEESH.R	P	P	P	P	P	P	P	P
12.	2201AP10112	HARI GANESH.R	P	P	P	P	P	P	P	P
13.	2201AP10113	KARTIKEYAN.M	P	P	P	P	P	P	P	P
14.	2201AP10114	RAJESH.R	P	P	P	P	P	P	P	P
15.	2201AP10115	AJAY.R	P	P	P	P	P	P	P	P
16.	2201AP10116	RAMESH.R	P	P	P	P	P	P	P	P
17.	2201AP10117	NAGENDRA KUMAR.R	P	P	P	P	P	P	P	P
18.	2201AP10118	HARISH KANAK.K	P	P	P	P	P	P	P	P
19.	2201AP10119	MOHAMED RIYAS.S	P	P	P	P	P	P	P	P
20.	2201AP10201	GIRIYON RAJ.R	P	P	P	P	P	P	P	P
21.	2201AP10202	GOKUL RAM.N	P	P	P	P	P	P	P	P
22.	2201AP10203	MEENATCHIL.K	P	P	P	P	P	P	P	P
23.	2201AP10204	GAJAPRIYA.D	P	P	P	P	P	P	P	P
24.	2201AP10205	VIJAYALAKSHMI.S	P	P	P	P	P	P	P	P
25.	2201AP10206	SRI SARVA.S	P	P	P	P	P	P	P	P
26.	2201AP10207	GUNA MARY.G	P	P	P	P	P	P	P	P
27.	2201AP10208	AARTHY.R	P	P	P	P	P	P	P	P
28.	2201AP10209	MONIKA.A	P	P	P	P	P	P	P	P
29.	2201AP10210	SWATHI.S	P	P	P	P	P	P	P	P
30.	2201AP10211	PAVITHRA.A	P	P	P	P	P	P	P	P
31.	2201AP10212	POOJA.M	P	P	P	P	P	P	P	P
32.	2201AP10213	RAJALAKSHMI.R	P	P	P	P	P	P	P	P
33.	2201AP10214	RAJESWARID	P	P	P	P	P	P	P	P



**PONNAIYAH RAMAJAYAM INSTITUTE OF
SCIENCE & TECHNOLOGY (PRIST)**

Declared as DEEMED-TO-BE UNIVERSITY
U/s 3 of UGC Act, 1956

34.	2201AP10215	SASIKALA.C	P	P	P	P	P	P	P	P	P	P	P	P	P	P	P	P	P	P
35.	2201AP10216	SHALINI.K	P	P	P	P	P	P	P	P	P	P	P	P	P	P	P	P	P	P
36.	2201AP10217	SHARMILADEVLH	P	P	P	P	P	P	P	P	P	P	P	P	P	P	P	P	P	P
37.	2201AP10218	SIVARANJINI.M	P	P	P	P	P	P	P	P	P	P	P	P	P	P	P	P	P	P
38.	2201AP10219	SUBASREE.G	P	P	P	P	P	P	P	P	P	P	P	P	P	P	P	P	P	P
39.	2201AP10220	SUMITHRA.G	P	P	P	P	P	P	P	P	P	P	P	P	P	P	P	P	P	P
40.	2201AP10221	THAMIZHARASLD	P	P	P	P	P	P	P	P	P	P	P	P	P	P	P	P	P	P
41.	2201AP10222	VIJAYALAKSHMI.P	P	P	P	P	P	P	P	P	P	P	P	P	P	P	P	P	P	P
42.	2201AP10223	GAYATHRI.D	P	P	P	P	P	P	P	P	P	P	P	P	P	P	P	P	P	P
43.	2201AP10224	SNEGA.R	P	P	P	P	P	P	P	P	P	P	P	P	P	P	P	P	P	P
44.	2201AP10225	PAVITHRAM	P	P	P	P	P	P	P	P	P	P	P	P	P	P	P	P	P	P
45.	2201AP10226	R. VIRGINIYA	P	P	P	P	P	P	P	P	P	P	P	P	P	P	P	P	P	P
46.	2201AP10227	S. SUSHMITHA	P	P	P	P	P	P	P	P	P	P	P	P	P	P	P	P	P	P
47.	2201AP10228	N.NITHIYA	P	P	P	P	P	P	P	P	P	P	P	P	P	P	P	P	P	P
48.	2201AP10229	J.JOSE ACCILIYA	P	P	P	P	P	P	P	P	P	P	P	P	P	P	P	P	P	P
49.	2201AP10230	PRAGATHIR	P	P	P	P	P	P	P	P	P	P	P	P	P	P	P	P	P	P
50.	2201AP10231	P.MIRUDHULA	P	P	P	P	P	P	P	P	P	P	P	P	P	P	P	P	P	P
51.	2201AP10232	J.LAVANVA	P	P	P	P	P	P	P	P	P	P	P	P	P	P	P	P	P	P
52.	2201AP10233	M.ROSHINI	P	P	P	P	P	P	P	P	P	P	P	P	P	P	P	P	P	P
53.	2201AP10234	A.SHAMBEERA BEGUM	P	P	P	P	P	P	P	P	P	P	P	P	P	P	P	P	P	P
54.	2201AP10236	G.AKILA	P	P	P	P	P	P	P	P	P	P	P	P	P	P	P	P	P	P
55.	2201AP10238	K.KAVIYA	P	P	P	P	P	P	P	P	P	P	P	P	P	P	P	P	P	P
56.	2201AP10239	M.ANUSHA	P	P	P	P	P	P	P	P	P	P	P	P	P	P	P	P	P	P
57.	2201AP10240	P.VINOTHINI	P	P	P	P	P	P	P	P	P	P	P	P	P	P	P	P	P	P
58.	2201AP10241	J.THULASI	P	P	P	P	P	P	P	P	P	P	P	P	P	P	P	P	P	P
59.	2201AP10242	B.NIVETHA	P	P	P	P	P	P	P	P	P	P	P	P	P	P	P	P	P	P
60.	2201AP10243	S.GOWSIKA	P	P	P	P	P	P	P	P	P	P	P	P	P	P	P	P	P	P

(Handwritten signatures and initials across the table)

Department of Commerce
Ponnaiyah Ramajayam Institute of
Science & Technology (PRIST)
Declared as DEEMED TO BE UNIVERSITY

DEAN
School of Commerce and Management
Ponnaiyah Ramajayam Institute of
Science & Technology (PRIST)
THANJAVUR - 613 403.



**PONNAIYAH RAMAJAYAM INSTITUTE OF
SCIENCE & TECHNOLOGY (PRIST)**

Declared as DEEMED-TO-BE UNIVERSITY
U/s 3 of UGC Act, 1956

S.NO	REG.NO	NAME	16/08/2023	17/08/2023	18/08/2023	07/09/2023	08/09/2023	12/09/2023	13/09/2023
1.	2201AP10101	SHAMSHAN.L	P	P	P	P	P	P	P
2.	2201AP10102	DEEPAKA	P	P	P	P	P	P	P
3.	2201AP10103	ARUNA	P	P	P	P	P	P	P
4.	2201AP10104	DHANUSH.G	P	P	P	P	P	P	P
5.	2201AP10105	RAGULA	P	P	P	P	P	P	P
6.	2201AP10106	HADAR ALI.H	P	P	P	P	P	P	P
7.	2201AP10107	IYAPPANA	P	P	P	P	P	P	P
8.	2201AP10108	GOKUL.SP	P	P	P	P	P	P	P
9.	2201AP10109	NARESH.V	P	P	P	P	P	P	P
10.	2201AP10110	MOHAMED ARSHATH ALI.M	P	P	P	P	P	P	P
11.	2201AP10111	PRAGADEESH.R	P	P	P	P	P	P	P
12.	2201AP10112	HARI GANESH.R	P	P	P	P	P	P	P
13.	2201AP10113	KARTIKEYAN.M	P	A	P	P	P	P	P
14.	2201AP10114	RAJESH.R	P	P	P	P	P	P	P
15.	2201AP10115	AJAYR	P	P	P	P	P	A	P
16.	2201AP10116	RAMESH.R	P	P	P	P	P	P	P
17.	2201AP10117	NAGENDRA KUMAR.R	P	P	P	P	P	P	P
18.	2201AP10118	HARISH KANAK.K	P	P	P	P	P	P	P
19.	2201AP10119	MOHAMED RIYASS	P	P	P	P	P	P	P
20.	2201AP10201	GIRIYON RAJ.R	P	P	P	P	P	P	P
21.	2201AP10202	GOKUL RAM.N	P	P	P	P	P	P	P
22.	2201AP10203	MEENATCHI.K	P	P	P	P	P	P	P
23.	2201AP10204	GAJAPRIYA.D	P	P	P	P	P	P	P
24.	2201AP10205	VIJAYALAKSHMI.S	P	P	P	P	P	P	P
25.	2201AP10206	SRI SARVA.S	P	P	P	P	P	P	P
26.	2201AP10207	GUNA MARY.G	P	P	P	P	P	P	P
27.	2201AP10208	AARTHY.R	P	P	P	P	P	P	P
28.	2201AP10209	MONIKA.A	P	P	P	P	P	P	P
29.	2201AP10210	SWATHI.S	P	P	P	P	P	P	P
30.	2201AP10211	PAVITHRA.A	P	P	P	P	P	P	P
31.	2201AP10212	POOJA.M	P	P	P	P	P	P	P
32.	2201AP10213	RAJALAKSHMI.R	P	P	P	P	P	P	P
33.	2201AP10214	RAJESWARI.D	P	P	P	P	P	P	P
34.	2201AP10215	SASIKALAC	P	P	P	P	P	P	P
35.	2201AP10216	SHALINI.K	P	P	P	P	P	P	P
36.	2201AP10217	SHARMILADEVI.H	P	P	P	P	P	P	P
37.	2201AP10218	SIVARANJINI.M	P	P	P	P	P	P	P
38.	2201AP10219	SUBASREE.G	P	P	P	P	P	P	P





PONNAIYAH RAMAJAYAM INSTITUTE OF SCIENCE & TECHNOLOGY (PRIST)

Declared as DEEMED TO BE UNIVERSITY
U/s 3 of UGC Act, 1956

39.	2201AP10220	SUMITHRA.G	P	P	P	P	P	P	P	P	P
40.	2201AP10221	THAMIZHARASID	P	P	P	P	P	P	P	P	P
41.	2201AP10222	VIJAYALAKSHMI.P	P	P	P	P	P	P	P	P	P
42.	2201AP10223	GAYATHRI.D	P	P	P	P	P	P	P	P	P
43.	2201AP10224	SNEGA.R	P	P	P	P	P	P	P	P	P
44.	2201AP10225	PAVITHRAM	P	P	P	A	P	P	P	P	P
45.	2201AP10226	R.VIRGINIYA	P	P	P	P	P	P	P	P	P
46.	2201AP10227	S.SUSHMITHA	P	P	P	P	P	P	P	P	P
47.	2201AP10228	N.NITHIYA	P	A	P	P	P	P	P	P	P
48.	2201AP10229	J.JOSE ACCILIYA	P	P	P	P	P	P	P	P	P
49.	2201AP10230	PRAGATHI.R	P	P	P	P	P	P	P	P	P
50.	2201AP10231	P.MIRUDHULA	P	P	P	P	P	P	P	P	P
51.	2201AP10232	J.LAVANYA	P	P	P	P	P	P	P	P	P
52.	2201AP10233	M.ROSHINI	P	P	P	P	P	P	P	P	P
53.	2201AP10234	A.SHAMEERA BEGUM	P	P	P	P	P	P	P	P	P
54.	2201AP10236	G.AKILA	P	P	P	P	P	P	P	P	P
55.	2201AP10238	K.KAVIYA	P	P	P	P	P	P	P	P	P
56.	2201AP10239	MANUSHA	A	P	P	P	P	P	P	P	P
57.	2201AP10240	P.VINOTHINI	P	P	P	P	P	A	P	P	P
58.	2201AP10241	J.THULASI	P	P	P	P	P	P	P	P	P
59.	2201AP10242	B.NIVETHA	P	P	P	P	P	P	P	P	P
60.	2201AP10243	S.GOWSIKA	P	P	P	P	P	P	P	P	P

Ob *Stk-1* *(S).vedha* *Op vedha* *Sps* *SPS* *SPS*

DEAN
 School of Commerce and Management
 Ponnaiyah Ramajayam Institute of
 Science & Technology (PRIST)
 THANJAVUR - 613 403.

Department of Commerce
 Ponnaiyah Ramajayam Institute of
 Science & Technology (PRIST),
 Declared as DEEMED TO BE UNIVERSITY



**PONNAIYAH RAMAJAYAM INSTITUTE OF
SCIENCE & TECHNOLOGY (PRIST)**

Declared as DEEMED TO BE UNIVERSITY
U/s 3 of UGC Act, 1956

CERTIFICATE COURSE IN GST

S.NO	REG.NO	NAME	17/07/2023	18/07/2023	19/07/2023	20/07/2023	21/07/2023	25/07/2023	26/07/2023	28/07/2023
1.	2201CM20101	R.MAHARDEEN	P	P	P	P	P	P	P	P
2.	2201CM20102	R.RAJESH	P	P	P	P	P	P	P	P
3.	2201CM20103	M.PRAKASH	P	P	P	P	P	P	P	P
4.	2201CM20104	K.MADHANRAJ	P	P	P	P	P	P	P	P
5.	2201CM20105	AJAYRAJ.S	P	P	P	P	P	P	P	P
6.	2201CM20106	AJEETH.S	P	P	P	P	P	P	P	P
7.	2201CM20107	S.MALATHI	P	P	P	P	P	P	P	P
8.	2201CM20108	ANANDHI.S	P	P	P	P	P	P	P	P
9.	2201CM20109	BUVANA.D	P	P	P	P	P	P	P	P
10.	2201CM20110	EZHILARASI.M	P	P	P	P	P	P	P	P
11.	2201CM20111	C.PRAVEENA	P	P	P	P	P	P	P	P
12.	2201CM20112	S.VIDHYASREE	P	P	P	P	P	P	P	P
13.	2201CM20113	J.GEETHA	P	A	P	P	P	P	P	P
14.	2201CM20114	KARTHIKEYAN.J	P	P	P	P	P	P	P	P
15.	2201CM20115	RANJANIN	P	P	P	P	P	A	P	P
16.	2201CM20116	M.SWATHI	P	P	P	P	P	P	P	P
17.	2201CM20201	MEEGA.M	P	P	P	P	P	P	P	P
18.	2201CM20202	T.VIJAYADHARSHINI	P	P	P	P	P	P	P	P
19.	2201CM20203	A.M.DUVETHA	P	P	P	P	P	P	P	P
20.	2201CM20204	R.PAVITHRA	P	P	P	P	P	P	P	P
21.	2301CM20101	MATHAVAN.V	P	P	P	P	P	P	P	P
22.	2301CM20102	BHARATHI.RAJ.K	P	P	P	P	P	P	P	P
23.	2301CM20103	VIJAY.S	P	P	P	P	P	P	P	P
24.	2301CM20104	AJITH.KUMAR.R	P	P	P	P	P	P	P	P
25.	2301CM20105	KIRIYON.M	P	P	P	P	P	P	P	P
26.	2301CM20106	ESWARAN.K	P	P	P	P	P	P	P	P
27.	2301CM20107	SELVENDHIRAN.S	P	P	P	P	P	P	P	P
28.	2301CM20108	WASIM.AHMED.A	P	P	P	P	P	P	P	P
29.	2301CM20109	MARESHWARAN.P	P	P	P	P	P	P	P	P
30.	2301CM20110	MANOJKUMAR.A	P	P	P	P	P	P	P	P
31.	2301CM20111	KALAIYARASAN.R	P	P	P	P	P	P	P	P
32.	2301CM20112	MOOVENDHAR.M	P	P	P	P	P	P	P	P
33.	2301CM20113	SELLAPILLAI.S	P	P	P	P	P	P	P	P
34.	2301CM20114	CINNA.DURAI.R	P	P	P	P	P	P	P	P



PONNAIYAH RAMAJAYAM INSTITUTE OF SCIENCE & TECHNOLOGY (PRIST)

Declared as DEEMED TO BE UNIVERSITY
U/s 3 of UGC Act, 1956

35	2301CM20115	VENKATESH G	P	P	P	P	P	P	P	P	P	P
36	2301CM20116	MANIKANDAN R	P	P	P	P	P	P	P	P	P	P
37	2301CM20117	VIGNESH R	P	P	P	P	P	P	P	P	P	P
38	2301CM20118	NAVIN P	P	P	P	P	P	P	P	P	P	P
39	2301CM20119	SIVAMANI K	P	P	P	P	P	P	P	P	P	P
40	2301CM20120	KISHORE RAHUL M	P	P	P	P	P	P	P	P	P	P
41	2301CM20201	MEENA R	P	P	P	P	P	P	P	P	P	P
42	2301CM20202	AARTHIS	P	P	P	P	P	P	P	P	P	P

SKJ *SKJ* *SKJ* *SKJ* *SKJ* *SKJ* *SKJ* *SKJ* *SKJ* *SKJ* *SKJ* *SKJ* *SKJ*

[Signature]
Department of Commerce
Ponnaiyah Ramajayam Institute of
Science & Technology (PRIST)
Declared as DEEMED TO BE UNIVERSITY

[Signature]
DEAN
School of Commerce and Management
Ponnaiyah Ramajayam Institute of
Science & Technology (PRIST)
VALLUVAJAYAPURAM-613 403.



**PONNAIYAH RAMAJAYAM INSTITUTE OF
SCIENCE & TECHNOLOGY (PRIST)**

Declared as DEEMED TO BE UNIVERSITY
U/s 3 of UGC Act, 1956

S.NO	REG.NO	NAME	31/07/2023	01/08/2023	03/08/2023	04/08/2023	08/08/2023	09/08/2023	10/08/2023	14/08/2023
1.	2201CM20101	R.MAHARDEEN	P	P	P	P	P	P	P	P
2.	2201CM20102	R.RAJESH	P	P	P	P	P	P	P	P
3.	2201CM20103	M.PRAKASH	P	P	P	P	P	P	P	P
4.	2201CM20104	K.MADHANRAJ	P	P	P	P	P	P	P	P
5.	2201CM20105	AJYRAJ.S	P	P	P	P	P	P	P	P
6.	2201CM20106	AJEETH.S	P	P	P	P	P	P	P	P
7.	2201CM20107	S.MALATHI	P	P	P	P	P	P	P	P
8.	2201CM20108	ANANDHI.S	P	P	P	P	P	P	P	P
9.	2201CM20109	BUVANA.D	P	P	P	P	P	P	P	P
10.	2201CM20110	EZHILARASI.M	P	P	P	P	P	P	P	P
11.	2201CM20111	C.PRAVEENA	P	P	P	P	P	P	P	P
12.	2201CM20112	S.VIDHYASREE	P	P	P	P	P	P	P	P
13.	2201CM20113	J.GEETHA	P	A	P	P	P	P	P	P
14.	2201CM20114	KARTHIKEYANJ	P	P	P	P	P	P	P	P
15.	2201CM20115	RANJANIN	P	P	P	P	P	A	P	P
16.	2201CM20116	M.SWATHI	P	P	P	P	P	P	P	P
17.	2201CM20201	MEEGA M	P	P	P	P	P	P	P	P
18.	2201CM20202	T.VIJAYADHARSHINI	P	P	P	P	P	P	P	P
19.	2201CM20203	A.M.DUVETHA	P	P	P	P	P	P	P	P
20.	2201CM20204	R.PAVITHRA	P	P	P	P	P	P	P	P
21.	2301CM20101	MATHAVAN V	P	P	P	P	P	P	P	P
22.	2301CM20102	BHARATHI RAJ K	P	P	P	P	P	P	P	P
23.	2301CM20103	VIJAY S	P	P	P	P	P	P	P	P
24.	2301CM20104	AJITH KUMAR R	P	P	P	P	P	P	P	P
25.	2301CM20105	KIRIYON M	P	P	P	P	P	P	P	P
26.	2301CM20106	ESWARAN K	P	P	P	P	P	P	P	P
27.	2301CM20107	SELVENDHIRAN S	P	P	P	P	P	P	P	P
28.	2301CM20108	WASIM AHAMED A	P	P	P	P	P	P	P	P
29.	2301CM20109	MAREESHWARAN P	P	P	P	P	P	P	P	P
30.	2301CM20110	MANOJKUMAR A	P	P	P	P	P	P	P	P
31.	2301CM20111	KALAIYARASAN R	P	P	P	P	P	P	P	P
32.	2301CM20112	MOOVENDHAR M	P	P	P	P	P	P	P	P
33.	2301CM20113	SELLAPILLAI S	P	P	P	P	P	P	P	P
34.	2301CM20114	CINNA DURAI R	P	P	P	P	P	P	P	P
35.	2301CM20115	VENKATESH G	P	P	P	P	P	P	P	P
36.	2301CM20116	MANIKANDAN R	P	P	P	P	P	P	P	P
37.	2301CM20117	VIGNESH R	P	P	P	P	P	P	P	P
38.	2301CM20118	NAVIN P	P	P	P	P	P	P	P	P



PONNAIYAH RAMAJAYAM INSTITUTE OF SCIENCE & TECHNOLOGY (PRIST)

Declared as DEEMED TO BE UNIVERSITY U/s 3 of UGC Act, 1956

39	2301CM20119	P	P	P	P	P	P	P	P	P	P
40	2301CM20120	P	P	P	P	P	P	P	P	P	P
41	2301CM20201	P	P	P	P	P	P	P	P	P	P
42	2301CM20202	P	P	P	P	P	P	P	P	P	P

PRIST *PRIST* *PRIST* *PRIST* *PRIST* *PRIST* *PRIST*
Pr. Subbaraj *Pr. Subbaraj* *Pr. Subbaraj* *Pr. Subbaraj* *Pr. Subbaraj* *Pr. Subbaraj* *Pr. Subbaraj*

Pr. Subbaraj
 Department of Commerce
 Ponnaiyah Ramajayam Institute of
 Science & Technology (PRIST)
 Declared as DEEMED TO BE UNIVERSITY

K. S. Jayaraman
 DEAN
 School of Commerce and Management
 Ponnaiyah Ramajayam Institute of
 Science & Technology (PRIST)
 THANJAVUR - 613 403



**PONNAIYAIL RAMAJAYAM INSTITUTE OF
SCIENCE & TECHNOLOGY (PRIST)**

Declared as DEFMED TO BE UNIVERSITY
U/s 3 of UGC Act, 1956

S.NO	REG.NO	NAME	16/08/2023	17/08/2023	18/08/2023	07/09/2023	08/09/2023	12/09/2023	13/09/2023
1.	2201CM20101	R.MAHARDEEN	P	P	P	P	P	P	P
2.	2201CM20102	R.RAJESH	P	P	P	P	P	P	P
3.	2201CM20103	M.PRAKASH	P	P	P	P	P	P	P
4.	2201CM20104	K.MADHANRAJ	P	P	P	P	P	P	P
5.	2201CM20105	AJAYRAJ.S	P	P	P	P	P	P	P
6.	2201CM20106	AJEETH.S	P	P	P	P	P	P	P
7.	2201CM20107	S.MALATHI	P	P	P	P	P	P	P
8.	2201CM20108	ANANDHI.S	P	P	P	P	P	P	P
9.	2201CM20109	BUVANA.D	P	P	P	P	P	P	P
10.	2201CM20110	EZHILARASI.M	P	P	P	P	P	P	P
11.	2201CM20111	C.PRAVEENA	P	P	P	P	P	P	P
12.	2201CM20112	S.VIDHYASREE	P	P	P	P	P	P	P
13.	2201CM20113	J.GEETHA	P	A	P	P	P	P	P
14.	2201CM20114	KARTHIKEYAN.J	P	P	P	P	P	P	P
15.	2201CM20115	RANJANI.N	P	P	P	P	P	P	P
16.	2201CM20116	M.SWATHI	P	P	P	P	P	A	P
17.	2201CM20201	MEEGA M	P	P	P	P	P	P	P
18.	2201CM20202	T.VIJAYADHARSHINI	P	P	P	P	P	P	P
19.	2201CM20203	A.M.DUVETHA	P	P	P	P	P	P	P
20.	2201CM20204	R.PAVITHRA	P	P	P	P	P	P	P
21.	2301CM20101	MATHAVAN V	P	P	P	P	P	P	P
22.	2301CM20102	BHARATHIRAJ K	P	P	P	P	P	P	P
23.	2301CM20103	VIJAY S	P	P	P	P	P	P	P
24.	2301CM20104	AJITH KUMAR R	P	P	P	P	P	P	P
25.	2301CM20105	KIRIYON M	P	P	P	P	P	P	P
26.	2301CM20106	ESWARAN K	P	P	P	P	P	P	P
27.	2301CM20107	SELVENDHIRAN S	P	P	P	P	P	P	P
28.	2301CM20108	WASIM AHAMED A	P	P	P	P	P	P	P
29.	2301CM20109	MAREESHWARAN P	P	P	P	P	P	P	P
30.	2301CM20110	MANOJKUMAR A	P	P	P	P	P	P	P
31.	2301CM20111	KALAIYARASAN R	P	P	P	P	P	P	P
32.	2301CM20112	MOOVENDHAR M	P	P	P	P	P	P	P
33.	2301CM20113	SELLAPILLAI S	P	P	P	P	P	P	P
34.	2301CM20114	CINNA DURAIR	P	P	P	P	P	P	P
35.	2301CM20115	VENKATESH G	P	P	P	P	P	P	P
36.	2301CM20116	MANIKANDAN R	P	P	P	P	P	P	P
37.	2301CM20117	VIGNESH R	P	P	P	P	P	P	P
38.	2301CM20118	NAVIN P	P	P	P	P	P	P	P
39.	2301CM20119	SIVAMANI K	P	P	P	P	P	P	P



PONNAIYAH RAMAJAYAM INSTITUTE OF SCIENCE & TECHNOLOGY (PRIST)

Declared as DEEMED-TO-BE-UNIVERSITY
U/s 3 of UGC Act, 1956

40.	2301CM20120	KISHORE RAHUL M	P	P	P	P	P	P	P	P
41.	2301CM20201	MEENA R	P	P	P	P	P	P	P	P
42.	2301CM20202	AARTHIS	P	P	P	P	P	P	P	P





K. Srinivas
HOD

Department of Commerce
Ponnaiyah Ramajayam Institute of
Science & Technology (PRIST),
Declared as DEEMED TO BE UNIVERSITY

K. Srinivas
DEAN

School of Commerce and Management
Ponnaiyah Ramajayam Institute of
Science & Technology (PRIST)
THANJAVUR - 613 403.



EVEN-SEM

Certificate Course In Business Process services in Insurance

S.NO	REG NO	NAME	23/01/2024	24/01/2024	25/01/2024	29/01/2024	30/01/2024	31/01/2024	01/02/2024	02/02/2024
1.	2301CM10101	MOHAMED NIRFAN N	P	P	P	P	P	P	P	P
2.	2301CM10104	SETHUPATHI S	P	P	P	P	P	P	P	P
3.	2301CM10105	HAMITH RASMI A	P	P	P	P	P	P	P	P
4.	2301CM10106	PRAGADBESH K	P	P	P	P	P	P	P	P
5.	2301CM10107	PRASANNA S	P	P	P	P	P	P	P	P
6.	2301CM10108	GOKUL M	P	P	P	P	P	P	P	P
7.	2301CM10109	SIJJAS AHAMED S	P	P	P	P	P	P	P	P
8.	2301CM10113	JESTINPUSHPARAJA A	P	P	P	P	P	P	P	P
9.	2301CM10114	KAVIYARASAN K	P	P	P	P	P	P	P	P
10.	2301CM10115	SABARIKIRISAN D	P	P	P	P	P	P	P	P
11.	2301CM10116	KATHIRVELAN D	P	P	P	P	P	P	P	P
12.	2301CM10117	SUDHARSAN P	P	P	P	P	P	P	P	P
13.	2301CM10120	MUHILAN K	P	A	P	P	P	P	P	P
14.	2301CM10121	PRASANNA S	P	P	P	P	P	P	P	P
15.	2301CM10122	VINESHKUMAR R	P	P	P	P	P	A	P	P
16.	2301CM10123	MOHAMED SHAHITH S	P	P	P	P	P	P	P	P
17.	2301CM10124	ANROSE A	P	P	P	P	P	P	P	P
18.	2301CM10125	JAYASURIYA P	P	P	P	P	P	P	P	P
19.	2301CM10126	SANKAR A	P	P	P	P	P	P	P	P
20.	2301CM10127	NAVIN K	P	P	P	P	P	P	P	P
21.	2301CM10128	RAGUL A	P	P	P	P	P	P	P	P
22.	2301CM10129	MOHAMED RASMIN A	P	P	P	P	P	P	P	P
23.	2301CM10130	BALAMURUGAN N	P	P	P	P	P	P	P	P
24.	2301CM10131	KATHIRAVAN P	P	P	P	P	P	P	P	P
25.	2301CM10132	TAMILSELVAN V	P	P	P	P	P	P	P	P
26.	2301CM10134	NAVEEN KUMAR C	P	P	P	P	P	P	P	P
27.	2301CM10135	MANOJ KUMAR K	P	P	P	P	P	P	P	P
28.	2301CM10137	JEGAN SANTHOSH G	P	P	P	P	P	P	P	P
29.	2301CM10138	DHARUN KUMAR R	P	P	P	P	P	P	P	P
30.	2301CM10202	BETHUSIVAJOTHI M	P	P	P	P	P	P	P	P
31.	2301CM10203	NIVETHA V	P	P	P	P	P	P	P	P
32.	2301CM10204	SRI RANJANA R	P	P	P	P	P	P	P	P
33.	2301CM10205	PRIYADHARSHINI S	P	P	P	P	P	P	P	P
34.	2301CM10206	ANU M	P	P	P	P	P	P	P	P
35.	2301CM10207	GEETHA M	P	P	P	P	P	P	P	P



**PONNAIYAH RAMAJAYAM INSTITUTE OF
SCIENCE & TECHNOLOGY (PRIST)**

Declared as DEEMED TO BE UNIVERSITY
U/s 3 of UGC Act. 1956

36	2301CM10208	VISHALI L	P	P	P	P	P	P	P	P
37	2301CM10209	BANU I	P	P	P	P	P	P	P	P
38	2301CM10210	HARINI P	P	P	P	P	P	P	P	P
39	2301CM10211	VISHNU PRIYA M	P	P	P	P	P	P	P	P
40	2301CM10212	OVIYA S	P	P	P	P	P	P	P	P
41	2301CM10213	LAVANYA H	P	P	P	P	P	P	P	P
42	2301CM10214	JEYA S	P	P	P	P	P	P	P	P
43	2301CM10215	DIVYA T	P	P	P	P	P	P	P	P
44	2301CM10216	LOHITHA MARY T	P	P	P	A	P	P	P	P
45	2301CM10217	VINOTHINI F	P	P	P	P	P	P	P	P
46	2301CM10218	SANGAVI Y	P	P	P	P	P	P	P	P
47	2301CM10219	JESIKA I	P	A	P	P	P	P	P	P
48	2301CM10220	KOBIKA M	P	P	P	P	P	P	P	P
49	2301CM10221	YAZHINI L	P	P	P	P	P	P	P	P
50	2301CM10222	LAVANYAG	P	P	P	P	P	P	P	P
51	2301CM10223	SANGARI P	P	P	P	P	P	P	P	A
52	2301CM10224	DHIVYA DHARSHINI L	P	P	P	P	P	P	P	P
53	2301CM10225	MARY T	P	P	P	P	P	P	P	P
54	2301CM10226	KANAMANI S	P	P	P	P	P	P	P	P
55	2301CM10227	KAVERY G	P	P	P	P	P	P	P	P
56	2301CM10228	KOBIKA G	A	P	P	P	P	P	P	P
57	2301CM10229	LATHA N	P	P	P	P	A	P	P	P
58	2301CM10230	ANU DHARSHINI K	P	P	P	P	P	P	P	P
59	2301CM10231	VASIKA L	P	P	P	P	P	P	P	P
60	2301CM10232	QUEENCY MARY	P	P	P	P	P	P	P	P

[Handwritten signatures and initials]

[Signature]
HOD,
Department of Commerce
Ponnaiyah Ramajayam Institute of
Science & Technology (PRIST),
Declared as DEEMED TO BE UNIVERSITY

[Signature]
DEAN
School of Commerce and Management
Ponnaiyah Ramajayam Institute of
Science & Technology (PRIST)
THANJAVUR - 613 403.



**PONNAIYAH RAMAJAYAM INSTITUTE OF
SCIENCE & TECHNOLOGY (PRIST)**

Declared as DEEMED TO BE UNIVERSITY
U/s 3 of UGC Act, 1956

S.NO	REG.NO	NAME	05/02/2024	07/02/2024	09/02/2024	12/02/2024	13/02/2024	15/02/2024	16/02/2024	20/02/2024
1.	2301CM10101	MOHAMED NIRFAN N	P	P	P	P	P	P	P	P
2.	2301CM10104	SETHUPATHI S	P	P	P	P	P	P	P	P
3.	2301CM10105	HAMITH RASMI A	P	P	P	P	P	P	P	P
4.	2301CM10106	FRAGADEESH K	P	P	P	P	P	P	P	P
5.	2301CM10107	FRASANNA S	P	P	P	P	P	P	P	P
6.	2301CM10108	GOKUL M	P	P	P	P	P	P	P	P
7.	2301CM10109	SIJJAS AHAMED S	P	P	P	P	P	P	P	P
8.	2301CM10113	JESTINPUSHPARAJA A	P	P	P	P	P	P	P	P
9.	2301CM10114	KAVIYARASAN K	P	P	P	P	P	P	P	P
10.	2301CM10115	SABARIKIRISAN D	P	P	P	P	P	P	P	P
11.	2301CM10116	KATHIRVELAN D	P	P	P	P	P	P	P	P
12.	2301CM10117	SUDHARSAN P	P	P	P	P	P	P	P	P
13.	2301CM10120	MUHLAN K	P	A	P	P	P	P	P	P
14.	2301CM10121	PRASANNA S	P	P	P	P	P	P	P	P
15.	2301CM10122	VINESHKUMAR R	P	P	P	P	P	A	P	P
16.	2301CM10123	MOHAMED SHAHITH S	P	P	P	P	P	P	P	P
17.	2301CM10124	ANROSE A	P	P	P	P	P	P	P	P
18.	2301CM10125	JAYASURIYA P	P	P	P	P	P	P	P	P
19.	2301CM10126	SANKAR A	P	P	P	P	P	P	P	P
20.	2301CM10127	NAVIN K	P	P	P	P	P	P	P	P
21.	2301CM10128	RAGUL A	P	P	P	P	P	P	P	P
22.	2301CM10129	MOHAMED RASMIN A	P	P	P	P	P	P	P	P
23.	2301CM10130	BALAMURUGAN N	P	P	P	P	P	P	P	P
24.	2301CM10131	KATHIRAVAN P	P	P	P	P	P	P	P	P
25.	2301CM10132	TAMILSELVAN V	P	P	P	P	P	P	P	P
26.	2301CM10134	NAVEEN KUMAR C	P	P	P	P	P	P	P	P
27.	2301CM10135	MANOJ KUMAR K	P	P	P	P	P	P	P	P
28.	2301CM10137	JEGAN SANTHOSH G	P	P	P	P	P	P	P	P
29.	2301CM10138	DHARUN KUMAR R	P	P	P	P	P	P	P	P
30.	2301CM10202	BETHUSIVAJOTHI M	P	P	P	P	P	P	P	P
31.	2301CM10203	NIVETHA V	P	P	P	P	P	P	P	P
32.	2301CM10204	SRI RANJANA R	P	P	P	P	P	P	P	P
33.	2301CM10205	PRIYADHARSHINI S	P	P	P	P	P	P	P	P
34.	2301CM10206	ANU M	P	P	P	P	P	P	P	P
35.	2301CM10207	GEETHA M	P	P	P	P	P	P	P	P
36.	2301CM10208	VISHALI L	P	P	P	P	P	P	P	P
37.	2301CM10209	BANU I	P	P	P	P	P	P	P	P



**PONNAIYAH RAMAJAYAM INSTITUTE OF
SCIENCE & TECHNOLOGY (PRIST)**

Declared as DEEMED-TO-BE UNIVERSITY
U/s 3 of UGC Act, 1956

38	2301CM10210	HARINI P	P	P	P	P	P	P	P	P
39	2301CM10211	VISHNU PRIYA M	P	P	P	P	P	P	P	P
40	2301CM10212	OVIYA S	P	P	P	P	P	P	P	P
41	2301CM10213	LAVANYA H	P	P	P	P	P	P	P	P
42	2301CM10214	JEYA S	P	P	P	P	P	P	P	P
43	2301CM10215	DIVYA T	P	P	P	P	P	P	P	P
44	2301CM10216	LOHITHA MARY T	P	P	P	A	P	P	P	P
45	2301CM10217	VINOTHINI F	P	P	P	P	P	P	P	P
46	2301CM10218	SANGAVI Y	P	P	P	P	P	P	P	P
47	2301CM10219	JESIKA I	P	A	P	P	P	P	P	P
48	2301CM10220	KOBIKA M	P	P	P	P	P	P	P	P
49	2301CM10221	YAZHINI L	P	P	P	P	P	P	P	P
50	2301CM10222	LAVANYAG	P	P	P	P	P	P	P	P
51	2301CM10223	SANGARI P	P	P	P	P	P	P	P	A
52	2301CM10224	DHIVYA DHARSHINI L	P	P	P	P	P	P	P	P
53	2301CM10225	MARY T	P	P	P	P	P	P	P	P
54	2301CM10226	KANAMANI S	P	P	P	P	P	P	P	P
55	2301CM10227	KAVERY G	P	P	P	P	P	P	P	P
56	2301CM10228	KOBIKA G	A	P	P	P	P	P	P	P
57	2301CM10229	LATHA N	P	P	P	P	A	P	P	P
58	2301CM10230	ANU DHARSHINI K	P	P	P	P	P	P	P	P
59	2301CM10231	VASIKA L	P	P	P	P	P	B	P	P
60	2301CM10232	QUEENCY MARY	P	P	P	P	P	P	P	P

Ch *Ch* *Ch* *Ch* *Ch* *Ch* *Ch* *Ch* *Ch* *Ch*

G. Sudha
HOD,
Department of Commerce
Ponnaiyah Ramajayam Institute of
Science & Technology (PRIST),
Declared as DEEMED TO BE UNIVERSITY

K. S. Jayaram
DEAN
School of Commerce and Management
Ponnaiyah Ramajayam Institute of
Science & Technology (PRIST)
THANJAVUR - 613 403.



**PONNAIYAH RAMAJAYAM INSTITUTE OF
SCIENCE & TECHNOLOGY (PRIST)**

Declared as DEEMED-TO-BE-UNIVERSITY
U/s 3 of UGC Act, 1956

S.NO	REG.NO	NAME	21/02/2024	04/03/2024	05/03/2024	07/03/2024	12/03/2024	13/03/2024	14/03/2024
1.	2301CM10101	MOHAMED NIRFAN N	P	P	P	P	P	P	P
2.	2301CM10104	SETHUPATHI S	P	P	P	P	P	P	P
3.	2301CM10105	HAMITH RASMI A	P	P	P	P	P	P	P
4.	2301CM10106	PRAGADEESH K	P	P	P	P	P	P	P
5.	2301CM10107	PRASANNA S	P	P	P	P	P	P	P
6.	2301CM10108	GOKUL M	P	P	P	P	P	P	P
7.	2301CM10109	SIJJAS AHAMED S	P	P	P	P	P	P	P
8.	2301CM10113	JESTINPUSHPARAJA A	P	P	P	P	P	P	P
9.	2301CM10114	KAVIYARASAN K	P	P	P	P	P	P	P
10.	2301CM10115	SABARIKIRISAN D	P	P	P	P	P	P	P
11.	2301CM10116	KATHIRVELAN D	P	P	P	P	P	P	P
12.	2301CM10117	SUDHARSAN P	P	P	P	P	P	P	P
13.	2301CM10120	MUHILAN K	P	A	P	P	P	P	P
14.	2301CM10121	PRASANNA S	P	P	P	P	P	P	P
15.	2301CM10122	VINESHKUMAR R	P	P	P	P	P	A	P
16.	2301CM10123	MOHAMED SHAHITH S	P	P	P	P	P	P	P
17.	2301CM10124	ANROSE A	P	P	P	P	P	P	P
18.	2301CM10125	JAYASURIYA P	P	P	P	P	P	P	P
19.	2301CM10126	SANKAR A	P	P	P	P	P	P	P
20.	2301CM10127	NAVIN K	P	P	P	P	P	P	P
21.	2301CM10128	RAGUL A	P	P	P	P	P	P	P
22.	2301CM10129	MOHAMED RASMIN A	P	P	P	P	P	P	P
23.	2301CM10130	BALAMURUGAN N	P	P	P	P	P	P	P
24.	2301CM10131	KATHIRAVAN P	P	P	P	P	P	P	P
25.	2301CM10132	TAMILSELVAN V	P	P	P	P	P	P	P
26.	2301CM10134	NAVEEN KUMAR C	P	P	P	P	P	P	P
27.	2301CM10135	MANOJ KUMAR K	P	P	P	P	P	P	P
28.	2301CM10137	JEGAN SANTHOSH G	P	P	P	P	P	P	P
29.	2301CM10138	DHARUN KUMAR R	P	P	P	P	P	P	P
30.	2301CM10202	BETHUSIVANOTHI M	P	P	P	P	P	P	P
31.	2301CM10203	NIVETHA V	P	P	P	P	P	P	P
32.	2301CM10204	SRI RANIANA R	P	P	P	P	P	P	P
33.	2301CM10205	PRIYADHARSHINI S	P	P	P	P	P	P	P
34.	2301CM10206	ANU M	P	P	P	P	P	P	P
35.	2301CM10207	GEETHA M	P	P	P	P	P	P	P
36.	2301CM10208	VISHALI L	P	P	P	P	P	P	P
37.	2301CM10209	BANU I	P	P	P	P	P	P	P
38.	2301CM10210	HARINI P	P	P	P	P	P	P	P



PONNAIYAH RAMAJAYAM INSTITUTE OF SCIENCE & TECHNOLOGY (PRIST)

Declared as DEEMED TO BE UNIVERSITY
U/s 3 of UGC Act, 1956

39	2301CM10211	VISHNU PRIYA M	P	P	P	P	P	P	P
40	2301CM10212	OVIYA S	P	P	P	P	P	P	P
41	2301CM10213	LAVANYA H	P	P	P	P	P	P	P
42	2301CM10214	JEYA S	P	P	P	P	P	P	P
43	2301CM10215	DIVYA T	P	P	P	P	P	P	P
44	2301CM10216	LOHITHA MARY T	P	P	P	P	P	P	P
45	2301CM10217	VINOTHINI F	P	P	P	A	P	P	P
46	2301CM10218	SANGAVI Y	P	P	P	P	P	P	P
47	2301CM10219	JESIKA I	P	P	P	P	P	P	P
48	2301CM10220	KOBIKA M	P	A	P	P	P	P	P
49	2301CM10221	YAZHINI L	P	P	P	P	P	P	P
50	2301CM10222	LAVANYAG	P	P	P	P	P	P	P
51	2301CM10223	SANGARI P	P	P	P	P	P	P	P
52	2301CM10224	DHIVYA DHARSHINI L	P	P	P	P	P	P	P
53	2301CM10225	MARY T	P	P	P	P	P	P	P
54	2301CM10226	KANAMANI S	P	P	P	P	P	P	P
55	2301CM10227	KAVERY G	P	P	P	P	P	P	P
56	2301CM10228	KOBIKA G	A	P	P	P	P	P	P
57	2301CM10229	LATHA N	P	P	P	P	A	P	P
58	2301CM10230	ANU DHARSHINI K	P	P	P	P	P	P	P
59	2301CM10231	VASIKA L	P	P	P	P	P	P	P
60	2301CM10232	QUEENCY MARY	P	P	P	P	P	P	P

(Handwritten signatures and initials)

(Handwritten signature)
HOD
Department of Commerce
Ponnaiyah Ramajayam Institute of
Science & Technology (PRIST),
Declared as DEEMED TO BE UNIVERSITY

(Handwritten signature)
DEAN
School of Commerce and Management
Ponnaiyah Ramajayam Institute of
Science & Technology (PRIST)
THANJAVUR - 613 403.



EVEN -SEM

Certificate Course in Sales force Business Administration Specialist

S.NO	REG NO	NAME	23/01/2024	24/01/2024	25/01/2024	29/01/2024	30/01/2024	31/01/2024	01/02/2024	02/02/2024
1	2301AP10101	DEEPAK R	P	P	P	P	P	P	P	P
2	2301AP10102	ABISHEK ROHAN G	P	P	P	P	P	P	P	P
3	2301AP10103	LOGESHWARAN G	P	P	P	P	P	P	P	P
4	2301AP10105	SAKTHIVEL G	P	P	P	P	P	P	P	P
5	2301AP10107	SRIRAM S	P	P	P	P	P	P	P	P
6	2301AP10108	CHANDRU S	P	P	P	P	P	P	P	P
7	2301AP10109	AADITYA M	P	P	P	P	P	P	P	P
8	2301AP10110	KEERTHIVASAN P	P	P	P	P	P	P	P	P
9	2301AP10111	MANI H	P	P	P	P	P	P	P	P
10	2301AP10112	GUNA SEKARAN B	P	P	P	P	P	P	P	P
11	2301AP10113	VINOTH G	P	P	P	P	P	P	P	P
12	2301AP10114	KAVIYARASU P	P	P	P	P	P	P	P	P
13	2301AP10115	AMUTHAN K	P	A	P	P	P	P	P	P
14	2301AP10116	MANOJ KUMAR T	P	P	P	P	P	P	P	P
15	2301AP10117	JAMEEL MOHAMMED H	P	P	P	P	P	A	P	P
16	2301AP10118	HADAR ALI P	P	P	P	P	P	P	P	P
17	2301AP10119	BALU H	P	P	P	P	P	P	P	P
18	2301AP10120	FARHAN T	P	P	P	P	P	P	P	P
19	2301AP10121	NARESH KUMAR T	P	P	P	P	P	P	P	P
20	2301AP10122	BALA SUBRAMANIYAN S	P	P	P	P	P	P	P	P
21	2301AP10123	NAVANEETHAN L	P	P	P	P	P	P	P	P
22	2301AP10124	KUMARA VEL P	P	P	P	P	P	P	P	P
23	2301AP10125	NAVEEN RAJ G	P	P	P	P	P	P	P	P
24	2301AP10126	CHUDESH U	P	P	P	P	P	P	P	P
25	2301AP10127	VEL RAJ K	P	P	P	P	P	P	P	P
26	2301AP10201	NIVETHA K	P	P	P	P	P	P	P	P
27	2301AP10202	DEVATHULASI R	P	P	P	P	P	P	P	P
28	2301AP10203	DURGA DEVI L	P	P	P	P	P	P	P	P
29	2301AP10204	SATHYA PRIYA S	P	P	P	P	P	P	P	P
30	2301AP10205	KAVERY G	P	P	P	P	P	P	P	P
31	2301AP10206	MALAR VIZHI T	P	P	P	P	P	P	P	P
32	2301AP10207	NANDHINI P	P	P	P	P	P	P	P	P
33	2301AP10208	MANGAI NILA R	P	P	P	P	P	P	P	P
34	2301AP10209	BALADHARSHINI G	P	P	P	P	P	P	P	P
35	2301AP10210	BARGAVI K	P	P	P	P	P	P	P	P
36	2301AP10211	FAREENA S	P	P	P	P	P	P	P	P



**PONNAIYAH RAMAJAYAM INSTITUTE OF
SCIENCE & TECHNOLOGY (PRIST)**

Declared as DEEMED-TO-BE UNIVERSITY
U/s 3 of UGC Act, 1956

37	2301AP10212	VENI G	P	P	P	P	P	P	P	P
38	2301AP10213	MALINI F	P	P	P	P	P	P	P	P
39	2301AP10214	NARUMUGI V	P	P	P	P	P	P	P	P
40	2301AP10215	KANNIGA H	P	P	P	P	P	P	P	P
41	2301AP10216	PRIYA DHARSHINI H	P	P	P	P	P	P	P	P
42	2301AP10217	UDHYA DEVI Y	P	P	P	P	P	P	P	P
43	2301AP10218	HASEENA K	P	P	P	P	P	P	P	P
44	2301AP10219	KUMARAVARSHINI K	P	P	P	A	P	P	P	P
45	2301AP10220	LAVANYA K	P	P	P	P	P	P	P	P
46	2301AP10221	SAROJA DEVI T	P	P	P	P	P	P	P	P
47	2301AP10222	PATHMINI D	P	A	P	P	P	P	P	P
48	2301AP10223	GUNAVATHY D	P	P	P	P	P	P	P	P
49	2301AP10224	MARDONA L	P	P	P	P	P	P	P	P
50	2301AP10225	MERLINA MARY G	P	P	P	P	P	P	P	P
51	2301AP10226	ANITHA U	P	P	P	P	P	P	P	A
52	2301AP10227	ANUSHIYA S	P	P	P	P	P	P	P	P
53	2301AP10228	DEVIKA A	P	P	P	P	P	P	P	P
54	2301AP10229	JANANI H	P	P	P	P	P	P	P	P
55	2301AP10230	MAHA D	P	P	P	P	P	P	P	P
56	2301AP10231	BAVANA C	A	P	P	P	P	P	P	P
57	2301AP10232	KAVIYA J	P	P	P	P	A	P	P	P
58	2301AP10233	LAKSHANA J	P	P	P	P	P	P	P	P
59	2301AP10234	JANAKI DEVI P	P	P	P	P	P	P	P	P
60	2301AP10235	MANGAIYARKARASI R	P	P	P	P	P	P	P	P

[Handwritten signatures and initials]

G. Sudha
HOD

Department of Commerce
Ponnaiyah Ramajayam Institute of
Science & Technology (PRIST),
Declared as DEEMED TO BE UNIVERSITY

K. Srinivas
DEAN

School of Commerce and Management
Ponnaiyah Ramajayam Institute of
Science & Technology (PRIST)
THANJAVUR - 613 403.



**PONNAIYAH RAMAJAYAM INSTITUTE OF
SCIENCE & TECHNOLOGY (PRIST)**

Declared as DEEMED TO BE UNIVERSITY
U/a 3 of UGC Act, 1956

S NO	REG.NO	NAME	05/02/2024	07/02/2024	09/02/2024	12/02/2024	13/02/2024	15/02/2024	16/02/2024	20/02/2024
1.	2301AP10101	DEEPAK R	P	P	P	P	P	P	P	P
2.	2301AP10102	ABISHEK ROHAN G	P	P	P	P	P	P	P	P
3.	2301AP10103	LOGESHWARAN G	P	P	P	P	P	P	P	P
4.	2301AP10105	SAKTHIVEL G	P	P	P	P	P	P	P	P
5.	2301AP10107	SRIRAM S	P	P	P	P	P	P	P	P
6.	2301AP10108	CHANDRU S	P	P	P	P	P	P	P	P
7.	2301AP10109	AADITYA M	P	P	P	P	P	P	P	P
8.	2301AP10110	KEERTHIVASAN P	P	P	P	P	P	P	P	P
9.	2301AP10111	MANI H	P	P	P	P	P	P	P	P
10.	2301AP10112	GUNA SEKARAN B	P	P	P	P	P	P	P	P
11.	2301AP10113	VINOTH G	P	P	P	P	P	P	P	P
12.	2301AP10114	KAVIYARASU P	P	P	P	P	P	P	P	P
13.	2301AP10115	AMUTHAN K	P	A	P	P	P	P	P	P
14.	2301AP10116	MANOJ KUMAR T	P	P	P	P	P	P	P	P
15.	2301AP10117	JAMEEL MOHAMMED H	P	P	P	P	P	A	P	P
16.	2301AP10118	HADAR ALI P	P	P	P	P	P	P	P	P
17.	2301AP10119	BALU H	P	P	P	P	P	P	P	P
18.	2301AP10120	FARHAN T	P	P	P	P	P	P	P	P
19.	2301AP10121	NARESH KUMAR T	P	P	P	P	P	P	P	P
20.	2301AP10122	BALA SUBRAMANIYAN S	P	P	P	P	P	P	P	P
21.	2301AP10123	NAVANEETHAN L	P	P	P	P	P	P	P	P
22.	2301AP10124	KUMARA VEL P	P	P	P	P	P	P	P	P
23.	2301AP10125	NAVEEN RAJ G	P	P	P	P	P	P	P	P
24.	2301AP10126	CHUDESH U	P	P	P	P	P	P	P	P
25.	2301AP10127	VEL RAJ K	P	P	P	P	P	P	P	P
26.	2301AP10201	NIVETHA K	P	P	P	P	P	P	P	P
27.	2301AP10202	DEVATHULASI R	P	P	P	P	P	P	P	P
28.	2301AP10203	DURGA DEVIL	P	P	P	P	P	P	P	P
29.	2301AP10204	SATHYA PRIYA S	P	P	P	P	P	P	P	P
30.	2301AP10205	KAVERY G	P	P	P	P	P	P	P	P
31.	2301AP10206	MALAR VIZHI T	P	P	P	P	P	P	P	P
32.	2301AP10207	NANDHINI P	P	P	P	P	P	P	P	P
33.	2301AP10208	MANGAI NILA R	P	P	P	P	P	P	P	P
34.	2301AP10209	BALADHARSHINI G	P	P	P	P	P	P	P	P
35.	2301AP10210	BARGAVI K	P	P	P	P	P	P	P	P
36.	2301AP10211	FAREENA S	P	P	P	P	P	P	P	P
37.	2301AP10212	VENI G	P	P	P	P	P	P	P	P
38.	2301AP10213	MALINI F	P	P	P	P	P	P	P	P



**PONNAIYAH RAMAJAYAM INSTITUTE OF
SCIENCE & TECHNOLOGY (PRIST)**

Declared as DEEMED TO BE UNIVERSITY
Via 3 of UGC Act, 1956

39	2301AP10214	NARUMUGI V	P	P	P	P	P	P	P	P
40	2301AP10215	KANNIGA H	P	P	P	P	P	P	P	P
41	2301AP10216	PRIYA DHARSHINI H	P	P	P	P	P	P	P	P
42	2301AP10217	UDHYA DEVI Y	P	P	P	P	P	P	P	P
43	2301AP10218	HASEENA K	P	P	P	P	P	P	P	P
44	2301AP10219	KUMARAVARSHINI K	P	P	P	A	P	P	P	P
45	2301AP10220	LAVANYA K	P	P	P	P	P	P	P	P
46	2301AP10221	SAROJA DEVI T	P	P	P	P	P	P	P	P
47	2301AP10222	PATHMINI D	P	A	P	P	P	P	P	P
48	2301AP10223	GUNAVATHY D	P	P	P	P	P	P	P	P
49	2301AP10224	MARDONA L	P	P	P	P	P	P	P	P
50	2301AP10225	MERLINA MARY G	P	P	P	P	P	P	P	P
51	2301AP10226	ANITHA U	P	P	P	P	P	P	P	A
52	2301AP10227	ANUSHIYA S	P	P	P	P	P	P	P	P
53	2301AP10228	DEVIKA A	P	P	P	P	P	P	P	P
54	2301AP10229	JANANI H	P	P	P	P	P	P	P	P
55	2301AP10230	MAHA D	P	P	P	P	P	P	P	P
56	2301AP10231	BAVANA G	A	P	P	P	P	P	P	P
57	2301AP10232	KAVIYA J	P	P	P	P	A	P	P	P
58	2301AP10233	LAKSHANA J	P	P	P	P	P	P	P	P
59	2301AP10234	JANAKI DEVI P	P	P	P	P	P	P	P	P
60	2301AP10235	MANGAIYARKARASI R	P	P	P	P	P	P	P	P

[Handwritten signatures and marks below the table]

[Handwritten signature]
HOD

Department of Commerce
Ponnaiyah Ramajayam Institute of
Science & Technology (PRIST),
Declared as DEEMED TO BE UNIVERSITY

[Handwritten signature]
DEAN

School of Commerce and Management
Ponnaiyah Ramajayam Institute of
Science & Technology (PRIST)
THANJAVUR - 613 403



**PONNAIYAH RAMAJAYAM INSTITUTE OF
SCIENCE & TECHNOLOGY (PRIST)**

Declared as DEEMED-TO-BE UNIVERSITY
U/n 3 of UGC Act, 1956

S.NO	REG.NO	NAME	21/02/2024	04/03/2024	05/03/2024	07/03/2024	12/03/2024	13/03/2024	14/03/2024
1.	2301AP10101	DEEPAK R	P	P	P	P	P	P	P
2.	2301AP10102	ABISHEK ROHAN G	P	P	P	P	P	P	P
3.	2301AP10103	LOGESHWARAN G	P	P	P	P	P	P	P
4.	2301AP10105	SAKTHIVEL G	P	P	P	P	P	P	P
5.	2301AP10107	SRIRAM S	P	P	P	P	P	P	P
6.	2301AP10108	CHANDRU S	P	P	P	P	P	P	P
7.	2301AP10109	AADITYA M	P	P	P	P	P	P	P
8.	2301AP10110	KEERTHIVASAN P	P	P	P	P	P	P	P
9.	2301AP10111	MANI H	P	P	P	P	P	P	P
10.	2301AP10112	GUNA SEKARAN B	P	P	P	P	P	P	P
11.	2301AP10113	VINOTH G	P	P	P	P	P	P	P
12.	2301AP10114	KAVIYARASU P	P	P	P	P	P	P	P
13.	2301AP10115	AMUTHAN K	P	A	P	P	P	P	P
14.	2301AP10116	MANOJ KUMAR T	P	P	P	P	P	P	P
15.	2301AP10117	JAMEEL MOHAMMED H	P	P	P	P	P	A	P
16.	2301AP10118	HADAR ALI P	P	P	P	P	P	P	P
17.	2301AP10119	BALU H	P	P	P	P	P	P	P
18.	2301AP10120	FARHAN T	P	P	P	P	P	P	P
19.	2301AP10121	NARESH KUMAR T	P	P	P	P	P	P	P
20.	2301AP10122	BALA SUBRAMANIYAN S	P	P	P	P	P	P	P
21.	2301AP10123	NAVANEETHAN L	P	P	P	P	P	P	P
22.	2301AP10124	KUMARA VEL P	P	P	P	P	P	P	P
23.	2301AP10125	NAVEEN RAJ G	P	P	P	P	P	P	P
24.	2301AP10126	CHUDESU U	P	P	P	P	P	P	P
25.	2301AP10127	VEL RAJ K	P	P	P	P	P	P	P
26.	2301AP10201	NIVETHA K	P	P	P	P	P	P	P
27.	2301AP10202	DEVATHULASI R	P	P	P	P	P	P	P
28.	2301AP10203	DURGA DEVI L	P	P	P	P	P	P	P
29.	2301AP10204	SATHYA PRIYA S	P	P	P	P	P	P	P
30.	2301AP10205	KAVERY G	P	P	P	P	P	P	P
31.	2301AP10206	MALAR VIJHI T	P	P	P	P	P	P	P
32.	2301AP10207	NANDHINI P	P	P	P	P	P	P	P
33.	2301AP10208	MANGAI NILA R	P	P	P	P	P	P	P
34.	2301AP10209	BALADHARSHINI G	P	P	P	P	P	P	P
35.	2301AP10210	BARGAVI K	P	P	P	P	P	P	P
36.	2301AP10211	FAREENA S	P	P	P	P	P	P	P
37.	2301AP10212	VENI G	P	P	P	P	P	P	P
38.	2301AP10213	MALINI F	P	P	P	P	P	P	P
39.	2301AP10214	NARUMUGI V	P	P	P	P	P	P	P



**PONNAIYAH RAMAJAYAM INSTITUTE OF
SCIENCE & TECHNOLOGY (PRIST)**

Declared as DEEMED TO BE UNIVERSITY
U/s 3 of UGC Act, 1956

40	2301AP10215	KANNIGA H	P	P	P	P	P	P	P
41	2301AP10216	PRIYA DHARSHINI H	P	P	P	P	P	P	P
42	2301AP10217	UDHYA DEVI Y	P	P	P	P	P	P	P
43	2301AP10218	HASEENA K	P	P	P	P	P	P	P
44	2301AP10219	KUMARAVARSHINI K	P	P	P	A	P	P	P
45	2301AP10220	LAVANYA K	P	P	P	P	P	P	P
46	2301AP10221	SAROJA DEVI T	P	P	P	P	P	P	P
47	2301AP10222	PATHMINI D	P	A	P	P	P	P	P
48	2301AP10223	GUNAVATHY D	P	P	P	P	P	P	P
49	2301AP10224	MARDONA L	P	P	P	P	P	P	P
50	2301AP10225	MERLINA MARY G	P	P	P	P	P	P	P
51	2301AP10226	ANITHA U	P	P	P	P	P	P	P
52	2301AP10227	ANUSHIYA S	P	P	P	P	P	P	P
53	2301AP10228	DEVIKA A	P	P	P	P	P	P	P
54	2301AP10229	JANANI H	P	P	P	P	P	P	P
55	2301AP10230	MAHA D	P	P	P	P	P	P	P
56	2301AP10231	BAVANA G	A	P	P	P	P	P	P
57	2301AP10232	KAVIYA J	P	P	P	P	A	P	P
58	2301AP10233	LAKSHANA J	P	P	P	P	P	P	P
59	2301AP10234	JANAKI DEVI P	P	P	P	P	P	P	P
60	2301AP10235	MANGAIYARKARASI R	P	P	P	P	P	P	P

[Handwritten signatures and initials below the table]

[Handwritten Signature]
Department of Commerce
Ponnaiyah Ramajayam Institute of
Science & Technology (PRIST),
Declared as DEEMED TO BE UNIVERSITY

[Handwritten Signature]
School of Commerce and Management
Ponnaiyah Ramajayam Institute of
Science & Technology (PRIST)
THANJAVUR - 613 403.



**PONNAIYAH RAMAJAYAM INSTITUTE OF
SCIENCE & TECHNOLOGY (PRIST)**

Declared as DEEMED-TO-BE-UNIVERSITY
U/s 3 of UGC Act, 1956

**SCHOOL OF COMMERCE AND MANAGEMENT
VALUE ADDED COURSE
DEPARTMENT OF COMMERCE
CERTIFICATE OF APPRECIATION**

This is to certify that Ms/Mr Sankar A Reg.No 2301CMT0126 has

Completed the value added course on Business Process Service in Insurance
from 28/01/24 to 14/03/24 during the academic year of 2023 to 2024.

COURSE COORDINATOR

HOD

DEAN

Department of Commerce
Ponnaiyah Ramajayam Institute of
Science & Technology (PRIST),
Declared as DEEMED TO BE UNIVERSITY

School of Commerce and Management
Ponnaiyah Ramajayam Institute of
Science & Technology (PRIST)
THANJAVUR - 613 403.



**PONNAIYAH RAMAJAYAM INSTITUTE OF
SCIENCE & TECHNOLOGY (PRIST)**
Declared as DEEMED-TO-BE UNIVERSITY
U/s 3 of UGC Act, 1956

**SCHOOL OF COMMERCE AND MANAGEMENT
VALUE ADDED COURSE
DEPARTMENT OF COMMERCE
CERTIFICATE OF APPRECIATION**

This is to certify that Ms/Mr N. MOHAMMED NUREEN Reg.No 2301CML101 has
Completed the value added course on CERTIFICATE COURSE IN BUSINESS PROCESS SERVICES
in Insurance from 23.01.24 to 14.03.24 during the academic year of 2023 to 2024.

K. S. Srinivasan
COURSE COORDINATOR

K. S. Srinivasan
HOD

K. S. Srinivasan
DEAN

Department of Commerce
Ponnaiyah Ramajayam Institute of
Science & Technology (PRIST),
Declared as DEEMED TO BE UNIVERSITY

School of Commerce and Management
Ponnaiyah Ramajayam Institute of
Science & Technology (PRIST)
THANJAVUR - 613 403.



**PONNAIYAH RAMAJAYAM INSTITUTE OF
SCIENCE & TECHNOLOGY (PRIST)**
Declared as DEEMED-TO-BE-UNIVERSITY
U/s 3 of UGC Act, 1956

**SCHOOL OF COMMERCE AND MANAGEMENT
VALUE ADDED COURSE
DEPARTMENT OF COMMERCE
CERTIFICATE OF APPRECIATION**

This is to certify that Ms/Mr S. SETHUPATHI Reg.No 2301CM10104 has

Completed the value added course on CERTIFICATE COURSE IN BUSINESS PROCESS SERVICES

W/IN SURFACE from 23.01.24 to 14.03.24 during the academic year of 2023 to 2024.

COURSE COORDINATOR

HOD

HOD

DEAN

DEAN

Department of Commerce
Ponnaiyah Ramajayam Institute of
Science & Technology (PRIST),
Declared as DEEMED TO BE UNIVERSITY

School of Commerce and Management
Ponnaiyah Ramajayam Institute of
Science & Technology (PRIST)
THANJAVUR - 613 403.



**PONNAIYAH RAMAJAYAM INSTITUTE OF
SCIENCE & TECHNOLOGY (PRIST)**
Declared as DEEMED-TO-BE UNIVERSITY
U/s 3 of UGC Act, 1956

**SCHOOL OF COMMERCE AND MANAGEMENT
VALUE ADDED COURSE
DEPARTMENT OF COMMERCE
CERTIFICATE OF APPRECIATION**

This is to certify that Ms/Mr A. HANITHA RASHI Reg.No 22AELCM10105 has
Completed the value added course on CERTIFICATE COURSE IN BUSINESS PROCESS SERVICES IN
INSURANCE from 28.01.24 to 14.03.24 during the academic year of 2023 to 2024.

[Signature]
COURSE COORDINATOR

[Signature]
HOD

MOD

[Signature]
DEAN

Department of Commerce
Ponnaiyah Ramajayam Institute of
Science & Technology (PRIST),
Declared as DEEMED TO BE UNIVERSITY

School of Commerce and Management
Ponnaiyah Ramajayam Institute of
Science & Technology (PRIST)
THANJAVUR - 613 403.



**PONNAIYAH RAMAJAYAM INSTITUTE OF
SCIENCE & TECHNOLOGY (PRIST)**
Declared as DEEMED-TO-BE-UNIVERSITY
U/s 3 of UGC Act, 1956

**SCHOOL OF COMMERCE AND MANAGEMENT
VALUE ADDED COURSE
DEPARTMENT OF COMMERCE
CERTIFICATE OF APPRECIATION**

This is to certify that Ms/Mr K. PrasadESH Reg.No 2301CH10106 has

Completed the value added course on CERTIFICATE COURSE IN BUSINESS PROCESS SERVICES IN
INSURANCE from 23.01.24 to 14.03.24 during the academic year of 2023 to 2024.

K. PrasadESH
COURSE COORDINATOR

K. PrasadESH
HOD

K. PrasadESH
DEAN

Department of Commerce
Ponnaiyah Ramajayam Institute of
Science & Technology (PRIST),
Declared as DEEMED TO BE UNIVERSITY

School of Commerce and Management
Ponnaiyah Ramajayam Institute of
Science & Technology (PRIST),
THANJAVUR - 613 403.



**PONNAIYAH RAMAJAYAM INSTITUTE OF
SCIENCE & TECHNOLOGY (PRIST)**
Declared as DEEMED-TO-BE-UNIVERSITY
U/s 3 of UGC Act, 1956

**SCHOOL OF COMMERCE AND MANAGEMENT
VALUE ADDED COURSE
DEPARTMENT OF COMMERCE
CERTIFICATE OF APPRECIATION**

This is to certify that Ms/Mr S. PRASANA Reg.No 2301CH10104 has
Completed the value added course on CERTIFICATE COURSE IN BUSINESS PROCESSES IN
INSURANCE from 28.01.24 to 14.03.24 during the academic year of 2023 to 2024.

[Signature]
COURSE COORDINATOR

HOD

[Signature]
DEAN

Department of Commerce
Ponnaiyah Ramajayam Institute of
Science & Technology (PRIST),
Declared as DEEMED TO BE UNIVERSITY

School of Commerce and Management
Ponnaiyah Ramajayam Institute of
Science & Technology (PRIST)
THANJAVUR - 613 403.



**PONNAIYAH RAMAJAYAM INSTITUTE OF
SCIENCE & TECHNOLOGY (PRIST)**

Declared as DEEMED-TO-BE UNIVERSITY
U/s 3 of UGC Act, 1956

**SCHOOL OF COMMERCE AND MANAGEMENT
VALUE ADDED COURSE
DEPARTMENT OF COMMERCE
CERTIFICATE OF APPRECIATION**

This is to certify that Ms/Mr M. GURU Reg.No 23D1CH10108 has

Completed the value added course on CERTIFICATE COURSE IN BUSINESS SERVICES IN
INSURANCE from 23.01.24 to 14.03.24 during the academic year of 2023 to 2024.

COURSE COORDINATOR

HOD

DEAN

DEAN

Department of Commerce
Ponnaiyah Ramajayam Institute of
Science & Technology (PRIST),
Declared as DEEMED TO BE UNIVERSITY

School of Commerce and Management
Ponnaiyah Ramajayam Institute of
Science & Technology (PRIST)
THANJAVUR - 613 403.



**PONNAIYAH RAMAJAYAM INSTITUTE OF
SCIENCE & TECHNOLOGY (PRIST)**

Declared as DEEMED-TO-BE-UNIVERSITY
U/s 3 of UGC Act, 1956

**SCHOOL OF COMMERCE AND MANAGEMENT
VALUE ADDED COURSE
DEPARTMENT OF COMMERCE
CERTIFICATE OF APPRECIATION**

This is to certify that Ms/Mr S. SITHAS AHAMED Reg.No 23012010109 has

Completed the value added course on CERTIFICATE COURSE IN BUSINESS PROCESS SERVICES IN
INSURANCE from 23.01.24 to 14.03.24 during the academic year of 2023 to 2024.

COURSE COORDINATOR

HOD

HOD

DEAN

DEAN

Department of Commerce
Ponnaiyah Ramajayam Institute of
Science & Technology (PRIST),
Declared as DEEMED TO BE UNIVERSITY

School of Commerce and Management
Ponnaiyah Ramajayam Institute of
Science & Technology (PRIST)
THANJAVUR - 613 403.



**PONNAIYAH RAMAJAYAM INSTITUTE OF
SCIENCE & TECHNOLOGY (PRIST)**

Declared as DEEMED-TO-BE-UNIVERSITY
U/s 3 of UGC Act, 1956

**SCHOOL OF COMMERCE AND MANAGEMENT
VALUE ADDED COURSE
DEPARTMENT OF COMMERCE
CERTIFICATE OF APPRECIATION**

This is to certify that Ms/Mr A. JESTINPUSHPERATH Reg.No 2301CH12113 has

Completed the value added course on CERTIFICATE COURSE IN BUSINESS SERVICES IN
INSURANCE from 23.01.24 to 14.03.24 during the academic year of 2023 to 2024.

COURSE COORDINATOR

HOD

DEAN

Department of Commerce
Ponnaiyah Ramajayam Institute of
Science & Technology (PRIST),
Declared as DEEMED TO BE UNIVERSITY

School of Commerce and Management
Ponnaiyah Ramajayam Institute of
Science & Technology (PRIST)
THANJAVUR - 613 403.



**PONNAIYAH RAMAJAYAM INSTITUTE OF
SCIENCE & TECHNOLOGY (PRIST)**
Declared as DEEMED TO BE UNIVERSITY
U/s 3 of UGC Act, 1956

**SCHOOL OF COMMERCE AND MANAGEMENT
VALUE ADDED COURSE
DEPARTMENT OF COMMERCE
CERTIFICATE OF APPRECIATION**

This is to certify that Ms/Mr K. JAYAPRASAN Reg.No 23a1cml011 has
Completed the value added course on CERTIFICATE COURSE IN ROUTINE PROCESS SERVICES IN
INSURANCE from 23.01.24 to 14.03.24 during the academic year of 2023 to 2024.

COURSE COORDINATOR

HOD

DEAN

Department of Commerce
Ponnaiyah Ramajayam Institute of
Science & Technology (PRIST),
Declared as DEEMED TO BE UNIVERSITY

School of Commerce and Management
Ponnaiyah Ramajayam Institute of
Science & Technology (PRIST)
THANJAVUR - 613 403.



**PONNAIYAH RAMAJAYAM INSTITUTE OF
SCIENCE & TECHNOLOGY (PRIST)**

Declared as DEEMED TO BE UNIVERSITY
U/s 3 of UGC Act, 1956

**SCHOOL OF COMMERCE AND MANAGEMENT
VALUE ADDED COURSE
DEPARTMENT OF COMMERCE
CERTIFICATE OF APPRECIATION**

This is to certify that Ms/Mr D. SARAVARISAN Reg.No 2301CM10115 has

Completed the value added course on CERTIFICATE COURSE IN BUYER'S SERVICES
IN SUPPLY from 23.01.24 to 14.03.24 during the academic year of 2023 to 2024.

COURSE COORDINATOR

HOD

HOD

DEAN

DEAN

Department of Commerce
Ponnaiyah Ramajayam Institute of
Science & Technology (PRIST),
Declared as DEEMED TO BE UNIVERSITY

School of Commerce and Management
Ponnaiyah Ramajayam Institute of
Science & Technology (PRIST)
THANJAVUR - 613 403.



**PONNAIYAH RAMAJAYAM INSTITUTE OF
SCIENCE & TECHNOLOGY (PRIST)**

Declared as DEEMED TO BE UNIVERSITY
U/s 3 of UGC Act, 1956

**SCHOOL OF COMMERCE AND MANAGEMENT
VALUE ADDED COURSE
DEPARTMENT OF COMMERCE
CERTIFICATE OF APPRECIATION**

This is to certify that Ms/Mr S. KATHIRVELAN Reg.No 23SC11016 has

Completed the value added course on CERTIFICATE COURSE IN BUSINESS PROCESS SERVICES
IN INDUSTRANCE from 23.01.24 to 14.03.24 during the academic year of 2023 to 2024.

COURSE COORDINATOR

HOD

HOD

DEAN

DEAN

Department of Commerce
Ponnaiyah Ramajayam Institute of
Science & Technology (PRIST),
Declared as DEEMED TO BE UNIVERSITY

School of Commerce and Management
Ponnaiyah Ramajayam Institute of
Science & Technology (PRIST)
THANJAVUR - 613 403.



**PONNAIYAH RAMAJAYAM INSTITUTE OF
SCIENCE & TECHNOLOGY (PRIST)**

Declared as DEEMED-TO-BE-UNIVERSITY
U/s 3 of UGC Act, 1956

**SCHOOL OF COMMERCE AND MANAGEMENT
VALUE ADDED COURSE
DEPARTMENT OF COMMERCE
CERTIFICATE OF APPRECIATION**

This is to certify that Ms/Mr P. SUDHARSHAN

Reg.No 23AICM15117 has

Completed the value added course on CERTIFICATE COURSE IN BUSINESS PROCESS SERVICES IN

ASSURANCE from 28.01.24 to 14.03.24 during the academic year of 2023 to 2024.

COURSE COORDINATOR

HOD

DEAN

DEAN

Department of Commerce
Ponnaiyah Ramajayam Institute of
Science & Technology (PRIST),
Declared as DEEMED TO BE UNIVERSITY

School of Commerce and Management
Ponnaiyah Ramajayam Institute of
Science & Technology (PRIST)
THANJAVUR - 613 403.



**PONNAIYAH RAMAJAYAM INSTITUTE OF
SCIENCE & TECHNOLOGY (PRIST)**
Declared as DEEMED-TO-BE-UNIVERSITY
U/s 3 of UGC Act, 1956

**SCHOOL OF COMMERCE AND MANAGEMENT
VALUE ADDED COURSE
DEPARTMENT OF COMMERCE
CERTIFICATE OF APPRECIATION**

This is to certify that Ms/Mr K. MULLAN Reg.No 23BCE10120 has

Completed the value added course on CERTIFICATE COURSE IN BUSINESS PROCESS SERVICES IN
INSURANCE from 23.01.24 to 14.03.24 during the academic year of 2023 to 2024.

K. Govindaraj
COURSE COORDINATOR

HOD

K. Govindaraj
DEAN

HOD

DEAN

Department of Commerce
Ponnaiyah Ramajayam Institute of
Science & Technology (PRIST),
Declared as DEEMED TO BE UNIVERSITY

School of Commerce and Management
Ponnaiyah Ramajayam Institute of
Science & Technology (PRIST)
THANJAVUR - 613 403.

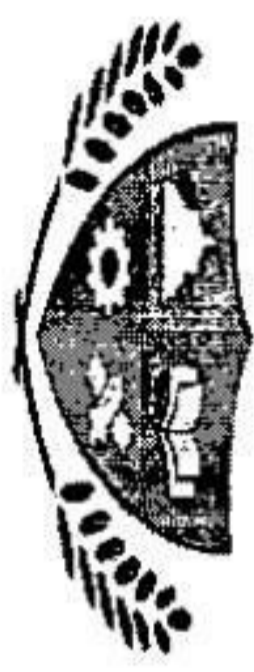

**PONNAIYAH RAMAJAYAM INSTITUTE OF
SCIENCE & TECHNOLOGY (PRIST)**
Declared as DEEMED-TO-BE-UNIVERSITY
U/s 3 of UGC Act, 1956

**SCHOOL OF COMMERCE AND MANAGEMENT
VALUE ADDED COURSE
DEPARTMENT OF COMMERCE
CERTIFICATE OF APPRECIATION**

This is to certify that Ms/Mr S. PRASANNA Reg.No 2301CH10121 has

Completed the value added course on CERTIFICATE COURSE IN BUSINESS PROCESS SERVICES IN
INSURANCE from 23.01.24 to 14.03.24 during the academic year of 2023 to 2024.

COURSE COORDINATOR

HOD

DEAN

Department of Commerce
Ponnaiyah Ramajayam Institute of
Science & Technology (PRIST),
Declared as DEEMED TO BE UNIVERSITY

School of Commerce and Management
Ponnaiyah Ramajayam Institute of
Science & Technology (PRIST)
THANJAVUR - 613 403.



**PONNAIYAH RAMAJAYAM INSTITUTE OF
SCIENCE & TECHNOLOGY (PRIST)**
Declared as DEEMED-TO-BE-UNIVERSITY
U/s 3 of UGC Act, 1956

**SCHOOL OF COMMERCE AND MANAGEMENT
VALUE ADDED COURSE
DEPARTMENT OF COMMERCE
CERTIFICATE OF APPRECIATION**

This is to certify that Ms/Mr R. NINESHYOMER Reg.No 2301CH12122 has

Completed the value added course on CERTIFICATE COURSE IN BUSINESS PROCESS ANALYSIS IN
MANAGEMENT from 23.01.24 to 14.03.24 during the academic year of 2023 to 2024.

K. Govindaraj
COURSE COORDINATOR

HOD

K. Govindaraj
DEAN

Department of Commerce
Ponnaiyah Ramajayam Institute of
Science & Technology (PRIST),
Declared as DEEMED TO BE UNIVERSITY

School of Commerce and Management
Ponnaiyah Ramajayam Institute of
Science & Technology (PRIST)
THANJAVUR - 613 403.



**PONNAIYAH RAMAJAYAM INSTITUTE OF
SCIENCE & TECHNOLOGY (PRIST)**
Declared as DEEMED-TO-BE-UNIVERSITY
U/s 3 of UGC Act, 1956

**SCHOOL OF COMMERCE AND MANAGEMENT
VALUE ADDED COURSE
DEPARTMENT OF COMMERCE
CERTIFICATE OF APPRECIATION**

This is to certify that Ms/Mr Mohamed Shahidh. S Reg.No 2301CM10123 has
Completed the value added course on Business Process Services in Insurance
from 28/01/24 to 14/03/24 during the academic year of 2023 to 2024.

COURSE COORDINATOR

HOD

HOD

DEAN

DEAN

Department of Commerce
Ponnaiyah Ramajayam Institute of
Science & Technology (PRIST),
Declared as DEEMED TO BE UNIVERSITY

School of Commerce and Management
Ponnaiyah Ramajayam Institute of
Science & Technology (PRIST)
THANJAVUR - 613 403.

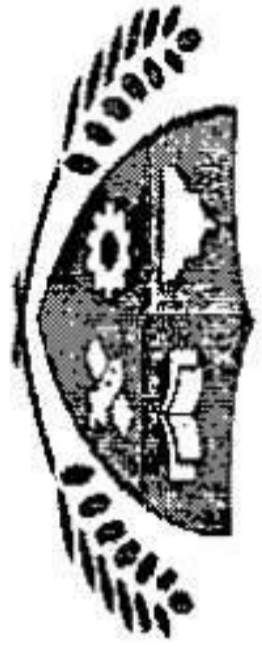

**PONNAIYAH RAMAJAYAM INSTITUTE OF
SCIENCE & TECHNOLOGY (PRIST)**
Declared as DEEMED-TO-BE-UNIVERSITY
U/s 3 of UGC Act, 1956

**SCHOOL OF COMMERCE AND MANAGEMENT
VALUE ADDED COURSE
DEPARTMENT OF COMMERCE
CERTIFICATE OF APPRECIATION**

This is to certify that Ms/Mr Annaya A Reg.No 2801CM10124 has

Completed the value added course on Business Process Services in Insurance
from 28/01/24 to 14/03/24 during the academic year of 2023 to 2024.

COURSE COORDINATOR

HOD

DEAN

Department of Commerce
Ponnaiyah Ramajayam Institute of
Science & Technology (PRIST),
Declared as DEEMED TO BE UNIVERSITY

School of Commerce and Management
Ponnaiyah Ramajayam Institute of
Science & Technology (PRIST)
THANJAVUR - 613 403.



**PONNAIYAH RAMAJAYAM INSTITUTE OF
SCIENCE & TECHNOLOGY (PRIST)**
Declared as DEEMED-TO-BE-UNIVERSITY
U/s 3 of UGC Act, 1956

**SCHOOL OF COMMERCE AND MANAGEMENT
VALUE ADDED COURSE
DEPARTMENT OF COMMERCE
CERTIFICATE OF APPRECIATION**

This is to certify that Ms/Mr Jayasriya . P Reg.No 2301CM10125 has
Completed the value added course on Business Process Services in Insurance
from 28/01/24 to 14/03/24 during the academic year of 2023 to 2024.

COURSE COORDINATOR

HOD

DEAN

Department of Commerce
Ponnaiyah Ramajayam Institute of
Science & Technology (PRIST),
Declared as DEEMED TO BE UNIVERSITY

School of Commerce and Management
Ponnaiyah Ramajayam Institute of
Science & Technology (PRIST)
THANJAVUR - 613 403.



**PONNAIYAH RAMAJAYAM INSTITUTE OF
SCIENCE & TECHNOLOGY (PRIST)**
Declared as DEEMED-TO-BE UNIVERSITY
U/s 3 of UGC Act, 1956

**SCHOOL OF COMMERCE AND MANAGEMENT
VALUE ADDED COURSE
DEPARTMENT OF COMMERCE
CERTIFICATE OF APPRECIATION**

This is to certify that Ms/Mr Navon Kumar .k Reg.No 2301CM10134 has
Completed the value added course on Business Process Services In Insurance
from 23/01/24 to 14/03/24 during the academic year of 2023 to 2024.

COURSE COORDINATOR

HOD

HOD

DEAN

DEAN

Department of Commerce
Ponnaiyah Ramajayam Institute of
Science & Technology (PRIST),
Declared as DEEMED TO BE UNIVERSITY

School of Commerce and Management
Ponnaiyah Ramajayam Institute of
Science & Technology (PRIST)
THANJAVUR - 613 403.



**PONNAIYAH RAMAJAYAM INSTITUTE OF
SCIENCE & TECHNOLOGY (PRIST)**
Declared as DEEMED-TO-BE UNIVERSITY
U/s 3 of UGC Act, 1956

**SCHOOL OF COMMERCE AND MANAGEMENT
VALUE ADDED COURSE
DEPARTMENT OF COMMERCE
CERTIFICATE OF APPRECIATION**

This is to certify that Ms/Mr Tamil Selvan V Reg.No 2301C0410132 has
Completed the value added course on Business Process Service in Tourism
from 23/01/24 to 14/03/24 during the academic year of 2023 to 2024.

COURSE COORDINATOR

HOD

DEAN

Department of Commerce
Ponnaiyah Ramajayam Institute of
Science & Technology (PRIST),
Declared as DEEMED TO BE UNIVERSITY

School of Commerce and Management
Ponnaiyah Ramajayam Institute of
Science & Technology (PRIST)
THANJAVUR - 613 403.



**PONNAIYAH RAMAJAYAM INSTITUTE OF
SCIENCE & TECHNOLOGY (PRIST)**

Declared as DEEMED-TO-BE-UNIVERSITY
U/s 3 of UGC Act, 1956

**SCHOOL OF COMMERCE AND MANAGEMENT
VALUE ADDED COURSE
DEPARTMENT OF COMMERCE
CERTIFICATE OF APPRECIATION**

This is to certify that Ms/Mr Mohamed Rasmin. B Reg.No 2301CM10129 has

Completed the value added course on Business Process Service in Insurance
from 23/08/24 to 14/10/24 during the academic year of 2023 to 2024.

COURSE COORDINATOR

HOD

DEAN

Department of Commerce
Ponnaiyah Ramajayam Institute of
Science & Technology (PRIST),
Declared as DEEMED TO BE UNIVERSITY

School of Commerce and Management
Ponnaiyah Ramajayam Institute of
Science & Technology (PRIST)
THANJAVUR - 613 403.



**PONNAIYAH RAMAJAYAM INSTITUTE OF
SCIENCE & TECHNOLOGY (PRIST)**

Declared as DEEMED-TO-BE UNIVERSITY
U/s 3 of UGC Act, 1956

**SCHOOL OF COMMERCE AND MANAGEMENT
VALUE ADDED COURSE
DEPARTMENT OF COMMERCE
CERTIFICATE OF APPRECIATION**

This is to certify that Ms/Mr Ragul. A Reg.No 2301CM10128 has

Completed the value added course on Business Process Service in Insurance
from 23/01/24 to 14/08/24 during the academic year of 2023 to 2024.

COURSE COORDINATOR

HOD

HOD

DEAN

DEAN

Department of Commerce
Ponnaiyah Ramajayam Institute of
Science & Technology (PRIST),
Declared as DEEMED TO BE UNIVERSITY

School of Commerce and Management
Ponnaiyah Ramajayam Institute of
Science & Technology (PRIST)
THANJAVUR - 613 403.



**PONNAIYAH RAMAJAYAM INSTITUTE OF
SCIENCE & TECHNOLOGY (PRIST)**
Declared as DEEMED-TO-BE UNIVERSITY
U/s 3 of UGC Act, 1956

**SCHOOL OF COMMERCE AND MANAGEMENT
VALUE ADDED COURSE
DEPARTMENT OF COMMERCE
CERTIFICATE OF APPRECIATION**

This is to certify that Ms/Mr Navin K Reg.No 2301CN10127 has
Completed the value added course on Business Process Service in Insurance
from 23/01/24 to 14/03/24 during the academic year of 2023 to 2024.

COURSE COORDINATOR

HOD

DEAN

Department of Commerce
Ponnaiyah Ramajayam Institute of
Science & Technology (PRIST),
Declared as DEEMED TO BE UNIVERSITY

School of Commerce and Management
Ponnaiyah Ramajayam Institute of
Science & Technology (PRIST)
THANJAVUR - 613 403.



**PONNAIYAH RAMAJAYAM INSTITUTE OF
SCIENCE & TECHNOLOGY (PRIST)**
Declared as DEEMED-TO-BE-UNIVERSITY
U/s 3 of UGC Act, 1956

**SCHOOL OF COMMERCE AND MANAGEMENT
VALUE ADDED COURSE
DEPARTMENT OF COMMERCE
CERTIFICATE OF APPRECIATION**

This is to certify that Ms/Mr Manoj Kumar K Reg.No 2301CMT16135 has
Completed the value added course on Business Process Service in Insurance
from 28/01/24 to 14/03/24 during the academic year of 2023 to 2024.

COURSE COORDINATOR

HOD

DEAN

Department of Commerce
Ponnaiyah Ramajayam Institute of
Science & Technology (PRIST),
Declared as DEEMED TO BE UNIVERSITY

School of Commerce and Management
Ponnaiyah Ramajayam Institute of
Science & Technology (PRIST)
THANJAVUR - 613 403.



**PONNAIYAH RAMAJAYAM INSTITUTE OF
SCIENCE & TECHNOLOGY (PRIST)**

Declared as DEEMED-TO-BE-UNIVERSITY
U/s 3 of UGC Act, 1956

**SCHOOL OF COMMERCE AND MANAGEMENT
VALUE ADDED COURSE
DEPARTMENT OF COMMERCE
CERTIFICATE OF APPRECIATION**

This is to certify that Ms/Mr Vinathini . I Reg.No 22BICM10250 has

Completed the value added course on Mutual Fund operations
from 17/07/23 to 13/09/23 during the academic year of 2023 to 2024.

[Signature]
COURSE COORDINATOR

[Signature]
HOD

[Signature]
DEAN

Department of Commerce
Ponnaiyah Ramajayam Institute of
Science & Technology (PRIST),
Declared as DEEMED TO BE UNIVERSITY

School of Commerce and Management
Ponnaiyah Ramajayam Institute of
Science & Technology (PRIST)
THANJAVUR - 613 403.



**PONNAIYAH RAMAJAYAM INSTITUTE OF
SCIENCE & TECHNOLOGY (PRIST)**
Declared as DEEMED TO BE UNIVERSITY
U/s 3 of UGC Act, 1956

**SCHOOL OF COMMERCE AND MANAGEMENT
VALUE ADDED COURSE
DEPARTMENT OF COMMERCE
CERTIFICATE OF APPRECIATION**

This is to certify that Ms/Mr V. Keerthivasan Reg.No 2101APP10131 has
Completed the value added course on Intellectual Property Rights
from 17/07/23 to 13/09/23 during the academic year of 2023 to 2024.

COURSE COORDINATOR

HOD

DEAN

Department of Commerce
Ponnaiyah Ramajayam Institute of
Science & Technology (PRIST),
Declared as DEEMED TO BE UNIVERSITY

School of Commerce and Management
Ponnaiyah Ramajayam Institute of
Science & Technology (PRIST)
THANJAVUR - 613 403.



**PONNAIYAH RAMAJAYAM INSTITUTE OF
SCIENCE & TECHNOLOGY (PRIST)**

Declared as DEEMED-TO-BE UNIVERSITY
U/s 3 of UGC Act, 1956

**SCHOOL OF COMMERCE AND MANAGEMENT
VALUE ADDED COURSE
DEPARTMENT OF COMMERCE
CERTIFICATE OF APPRECIATION**

This is to certify that Ms/Mr R. DEEPAK

Reg.No 2301AP10101 has

Completed the value added course on CERTIFICATE COURSE IN SALES FORCE BUSINESS ADMINISTRATION

SPECIALTY from 23.01.24 to 14.03.24 during the academic year of 2023 to 2024.

COURSE COORDINATOR

HOD

DEAN

DEAN

Department of Commerce
Ponnaiyah Ramajayam Institute of
Science & Technology (PRIST),
Declared as DEEMED TO BE UNIVERSITY

School of Commerce and Management
Ponnaiyah Ramajayam Institute of
Science & Technology (PRIST)
THANJAVUR - 613 403.



**PONNAIYAH RAMAJAYAM INSTITUTE OF
SCIENCE & TECHNOLOGY (PRIST)**

Declared as DEEMED TO BE UNIVERSITY
U/s 3 of UGC Act, 1956

**SCHOOL OF COMMERCE AND MANAGEMENT
VALUE ADDED COURSE
DEPARTMENT OF COMMERCE
CERTIFICATE OF APPRECIATION**

This is to certify that Ms/Mr R Mahabalan Reg.No 2201CM20101 has

Completed the value added course on Certificate Course in GST
from 11/07/23 to 13/09/23 during the academic year of 2023 to 2024.

COURSE COORDINATOR

HOD

DEAN

DEAN

Department of Commerce
Ponnaiyah Ramajayam Institute of
Science & Technology (PRIST),
Declared as DEEMED TO BE UNIVERSITY

School of Commerce and Management
Ponnaiyah Ramajayam Institute of
Science & Technology (PRIST)
THANJAVUR - 613 403.



**PONNAIYAH RAMAJAYAM INSTITUTE OF
SCIENCE & TECHNOLOGY (PRIST)**
Declared as DEEMED-TO-BE UNIVERSITY
U/s 3 of UGC Act, 1956

**SCHOOL OF COMMERCE AND MANAGEMENT
VALUE ADDED COURSE
DEPARTMENT OF COMMERCE
CERTIFICATE OF APPRECIATION**

This is to certify that Ms/Mr P. Rajesh Reg.No 2201CMT20102 has

Completed the value added course on Certificate Course in GST
from 17/07/23 to 13/09/23 during the academic year of 2023 to 2024.

COURSE COORDINATOR

HOD

DEAN

DEAN

Department of Commerce
Ponnaiyah Ramajayam Institute of
Science & Technology (PRIST),
Declared as DEEMED TO BE UNIVERSITY

School of Commerce and Management
Ponnaiyah Ramajayam Institute of
Science & Technology (PRIST)
THANJAVUR - 613 403.

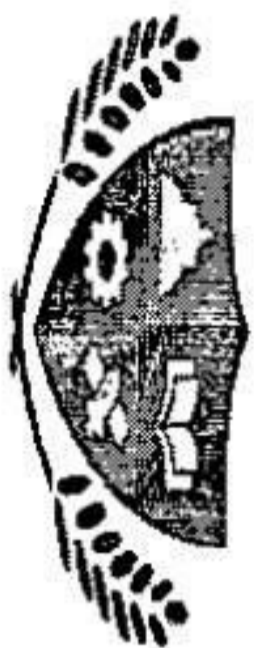

**PONNAIYAH RAMAJAYAM INSTITUTE OF
SCIENCE & TECHNOLOGY (PRIST)**
Declared as DEEMED TO-BE-UNIVERSITY
U/s 3 of UGC Act, 1956

**SCHOOL OF COMMERCE AND MANAGEMENT
VALUE ADDED COURSE
DEPARTMENT OF COMMERCE
CERTIFICATE OF APPRECIATION**

This is to certify that Ms/Mr M. Prakash Reg.No 2201CN20103 has

Completed the value added course on Certificate Course in GST
from 17/07/23 to 13/09/23 during the academic year of 2023 to 2024.

COURSE COORDINATOR

HOD

DEAN

DEAN

Department of Commerce
Ponnaiyah Ramajayam Institute of
Science & Technology (PRIST),
Declared as DEEMED TO BE UNIVERSITY

School of Commerce and Management
Ponnaiyah Ramajayam Institute of
Science & Technology (PRIST)
THANJAVUR - 613 403.



**PONNAIYAH RAMAJAYAM INSTITUTE OF
SCIENCE & TECHNOLOGY (PRIST)**
Declared as DEEMED-TO-BE UNIVERSITY
U/s 3 of UGC Act, 1956

**SCHOOL OF COMMERCE AND MANAGEMENT
VALUE ADDED COURSE
DEPARTMENT OF COMMERCE
CERTIFICATE OF APPRECIATION**

This is to certify that Ms/Mr K. Madhanay Reg.No 2201C M 20104 has

Completed the value added course on Certificate Course in GST
from 17/07/23 to 13/09/23 during the academic year of 2023 to 2024.

COURSE COORDINATOR

HOD

DEAN

DEAN

Department of Commerce
Ponnaiyah Ramajayam Institute of
Science & Technology (PRIST),
Declared as DEEMED TO BE UNIVERSITY

School of Commerce and Management
Ponnaiyah Ramajayam Institute of
Science & Technology (PRIST)
THANJAVUR - 613 403.



**PONNAIYAH RAMAJAYAM INSTITUTE OF
SCIENCE & TECHNOLOGY (PRIST)**
Declared as DEEMED-TO-BE-UNIVERSITY
U/s 3 of UGC Act, 1956

**SCHOOL OF COMMERCE AND MANAGEMENT
VALUE ADDED COURSE
DEPARTMENT OF COMMERCE
CERTIFICATE OF APPRECIATION**

This is to certify that Ms/Mr Ajayraj S Reg.No 2201CM20105 has
Completed the value added course on Certificate Course in GST
from 17/07/23 to 13/09/23 during the academic year of 2023 to 2024.

COURSE COORDINATOR

HOD

DEAN

Department of Commerce
Ponnaiyah Ramajayam Institute of
Science & Technology (PRIST),
Declared as DEEMED TO BE UNIVERSITY

School of Commerce and Management
Ponnaiyah Ramajayam Institute of
Science & Technology (PRIST)
THANJAVUR - 613 403.



**PONNAIYAH RAMAJAYAM INSTITUTE OF
SCIENCE & TECHNOLOGY (PRIST)**

Declared as DEEMED-TO-BE-UNIVERSITY
U/s 3 of UGC Act, 1956

**SCHOOL OF COMMERCE AND MANAGEMENT
VALUE ADDED COURSE
DEPARTMENT OF COMMERCE
CERTIFICATE OF APPRECIATION**

This is to certify that Ms/Mr Ajeetha S Reg.No 2201CNG20106has

Completed the value added course on Certificate Course in GST
from 17/07/23 to 13/09/23 during the academic year of 2023 to 2024.

COURSE COORDINATOR

HOD

DEAN

Department of Commerce
Ponnaiyah Ramajayam Institute of
Science & Technology (PRIST),
Declared as DEEMED TO BE UNIVERSITY

School of Commerce and Management
Ponnaiyah Ramajayam Institute of
Science & Technology (PRIST)
THANJAVUR - 613 403.



**PONNAIYAH RAMAJAYAM INSTITUTE OF
SCIENCE & TECHNOLOGY (PRIST)**
Declared as DEEMED-TO-BE-UNIVERSITY
U/S 3 of UGC Act, 1956

**SCHOOL OF COMMERCE AND MANAGEMENT
VALUE ADDED COURSE
DEPARTMENT OF COMMERCE
CERTIFICATE OF APPRECIATION**

This is to certify that Ms/Mr S. Malathi Reg.No 2201CN20107 has

Completed the value added course on Certificate Course in OST
from 17/07/23 to 13/09/23 during the academic year of 2023 to 2024.

COURSE COORDINATOR

HOD

DEAN

Department of Commerce
Ponnaiyah Ramajayam Institute of
Science & Technology (PRIST),
Declared as DEEMED TO BE UNIVERSITY

School of Commerce and Management
Ponnaiyah Ramajayam Institute of
Science & Technology (PRIST)
THANJAVUR - 613 403.

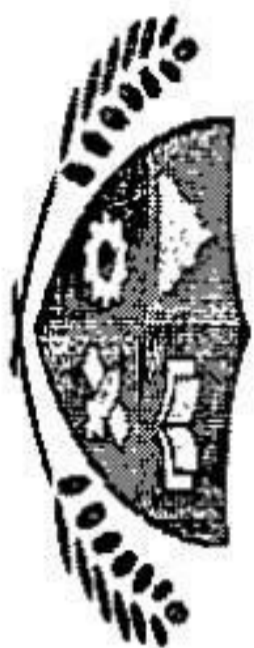

**PONNAIYAH RAMAJAYAM INSTITUTE OF
SCIENCE & TECHNOLOGY (PRIST)**
Declared as DEEMED-TO-BE UNIVERSITY
U/s 3 of UGC Act, 1956

**SCHOOL OF COMMERCE AND MANAGEMENT
VALUE ADDED COURSE
DEPARTMENT OF COMMERCE
CERTIFICATE OF APPRECIATION**

This is to certify that Ms/Mr Anandhi S Reg.No 2201CN220108 has

Completed the value added course on Certificate Course in GST
from 17/07/23 to 18/09/23 during the academic year of 2023 to 2024.

COURSE COORDINATOR

HOD

DEAN

Department of Commerce
Ponnaiyah Ramajayam Institute of
Science & Technology (PRIST),
Declared as DEEMED TO BE UNIVERSITY

School of Commerce and Management
Ponnaiyah Ramajayam Institute of
Science & Technology (PRIST),
THANJAVUR - 613 403.



**PONNAIYAH RAMAJAYAM INSTITUTE OF
SCIENCE & TECHNOLOGY (PRIST)**
Declared as DEEMED TO BE UNIVERSITY
U/S 3 of UGC Act, 1956

**SCHOOL OF COMMERCE AND MANAGEMENT
VALUE ADDED COURSE
DEPARTMENT OF COMMERCE
CERTIFICATE OF APPRECIATION**

This is to certify that Ms/Mr Buwana D Reg.No 2201CN120102 has

Completed the value added course on Anti-Financial Fraud in GST
from 17/07/23 to 13/09/23 during the academic year of 2023 to 2024.

COURSE COORDINATOR

HOD

DEAN

Department of Commerce
Ponnaiyah Ramajayam Institute of
Science & Technology (PRIST),
Declared as DEEMED TO BE UNIVERSITY

School of Commerce and Management
Ponnaiyah Ramajayam Institute of
Science & Technology (PRIST)
THANJAVUR - 613 403.



**PONNAIYAH RAMAJAYAM INSTITUTE OF
SCIENCE & TECHNOLOGY (PRIST)**
Declared as DEEMED-TO-BE UNIVERSITY
U/s 3 of UGC Act, 1956

**SCHOOL OF COMMERCE AND MANAGEMENT
VALUE ADDED COURSE
DEPARTMENT OF COMMERCE
CERTIFICATE OF APPRECIATION**

This is to certify that Ms/Mr Ezhilarasi, N Reg.No 2201C1920110 has
Completed the value added course on Certificate Course in GST
from 17/07/23 to 13/09/23 during the academic year of 2023 to 2024.

COURSE COORDINATOR

HOD

DEAN

Department of Commerce
Ponnaiyah Ramajayam Institute of
Science & Technology (PRIST),
Declared as DEEMED TO BE UNIVERSITY

School of Commerce and Management
Ponnaiyah Ramajayam Institute of
Science & Technology (PRIST)
THANJAVUR - 613 403.



**PONNAIYAH RAMAJAYAM INSTITUTE OF
SCIENCE & TECHNOLOGY (PRIST)**
Declared as DEEMED-TO-BE-UNIVERSITY
U/s 3 of UGC Act, 1956

**SCHOOL OF COMMERCE AND MANAGEMENT
VALUE ADDED COURSE
DEPARTMENT OF COMMERCE
CERTIFICATE OF APPRECIATION**

This is to certify that Ms/Mr C. Pavanya Reg.No 22D1CN220111 has
Completed the value added course on Certificate Course in GST
from 17/07/23 to 13/09/23 during the academic year of 2023 to 2024.

[Signature]
COURSE COORDINATOR

[Signature]
HOD

[Signature]
DEAN

Department of Commerce
Ponnaiyah Ramajayam Institute of
Science & Technology (PRIST),
Declared as DEEMED TO BE UNIVERSITY

School of Commerce and Management
Ponnaiyah Ramajayam Institute of
Science & Technology (PRIST)
THANJAVUR - 613 403.



**PONNAIYAH RAMAJAYAM INSTITUTE OF
SCIENCE & TECHNOLOGY (PRIST)**
Declared as DEEMED-TO-BE-UNIVERSITY
U/s 3 of UGC Act, 1956

**SCHOOL OF COMMERCE AND MANAGEMENT
VALUE ADDED COURSE
DEPARTMENT OF COMMERCE
CERTIFICATE OF APPRECIATION**

This is to certify that Ms/Mr S. Vidhyasree Reg.No 22D1CM20112 has

Completed the value added course on Certificate Course in GST
from 17/07/23 to 13/09/23 during the academic year of 2023 to 2024.

COURSE COORDINATOR

HOD

DEAN

Department of Commerce
Ponnaiyah Ramajayam Institute of
Science & Technology (PRIST),
Declared as DEEMED TO BE UNIVERSITY

School of Commerce and Management
Ponnaiyah Ramajayam Institute of
Science & Technology (PRIST)
THANJAVUR - 613 403.



**PONNAIYAH RAMAJAYAM INSTITUTE OF
SCIENCE & TECHNOLOGY (PRIST)**
Declared as DEEMED TO BE UNIVERSITY
U/s 3 of UGC Act, 1956

**SCHOOL OF COMMERCE AND MANAGEMENT
VALUE ADDED COURSE
DEPARTMENT OF COMMERCE
CERTIFICATE OF APPRECIATION**

This is to certify that Ms/Mr Geetha J Reg.No 2201CN920113 has

Completed the value added course on Certificate Course in GST
from 17/07/23 to 13/09/23 during the academic year of 2023 to 2024.

[Signature]
COURSE COORDINATOR

[Signature]
HOD

[Signature]
DEAN

Department of Commerce
Ponnaiyah Ramajayam Institute of
Science & Technology (PRIST),
Declared as DEEMED TO BE UNIVERSITY

School of Commerce and Management
Ponnaiyah Ramajayam Institute of
Science & Technology (PRIST)
THANJAVUR - 613 403.



**PONNAIYAH RAMAJAYAM INSTITUTE OF
SCIENCE & TECHNOLOGY (PRIST)**
Declared as DEEMED-TO-BE UNIVERSITY
U/s 3 of UGC Act, 1956

**SCHOOL OF COMMERCE AND MANAGEMENT
VALUE ADDED COURSE
DEPARTMENT OF COMMERCE
CERTIFICATE OF APPRECIATION**

This is to certify that Ms/Mr J. Karthikeyan Reg.No 2201C M 20114 has
Completed the value added course on Certificate Course in GST
from 11/07/23 to 13/09/23 during the academic year of 2023 to 2024.

[Signature]
COURSE COORDINATOR

HOD

[Signature]
DEAN

Department of Commerce
Ponnaiyah Ramajayam Institute of
Science & Technology (PRIST),
Declared as DEEMED TO BE UNIVERSITY

School of Commerce and Management
Ponnaiyah Ramajayam Institute of
Science & Technology (PRIST)
THANJAVUR - 613 403.



**PONNAIYAH RAMAJAYAM INSTITUTE OF
SCIENCE & TECHNOLOGY (PRIST)**
Declared as DEEMED TO BE UNIVERSITY
U/s 3 of UGC Act, 1956

**SCHOOL OF COMMERCE AND MANAGEMENT
VALUE ADDED COURSE
DEPARTMENT OF COMMERCE
CERTIFICATE OF APPRECIATION**

This is to certify that Ms/Mr Ranjani N Reg.No 2201CN220115 has

Completed the value added course on Certificate Course in GST
from 17/07/23 to 13/09/23 during the academic year of 2023 to 2024.

COURSE COORDINATOR

HOD

DEAN

Department of Commerce
Ponnaiyah Ramajayam Institute of
Science & Technology (PRIST),
Declared as DEEMED TO BE UNIVERSITY

School of Commerce and Management
Ponnaiyah Ramajayam Institute of
Science & Technology (PRIST)
THANJAVUR - 613 403.



**PONNAIYAH RAMAJAYAM INSTITUTE OF
SCIENCE & TECHNOLOGY (PRIST)**
Declared as DEEMED-TO-BE-UNIVERSITY
U/s 3 of UGC Act, 1956

**SCHOOL OF COMMERCE AND MANAGEMENT
VALUE ADDED COURSE
DEPARTMENT OF COMMERCE
CERTIFICATE OF APPRECIATION**

This is to certify that Ms/Mr M. Senthil Reg.No 2201CM190116 has

Completed the value added course on Certificate Course in GST
from 17/07/23 to 13/09/23 during the academic year of 2023 to 2024.

COURSE COORDINATOR

HOD

DEAN

Department of Commerce
Ponnaiyah Ramajayam Institute of
Science & Technology (PRIST)
Declared as DEEMED TO BE UNIVERSITY

School of Commerce and Management
Ponnaiyah Ramajayam Institute of
Science & Technology (PRIST)
THANJAVUR - 613 403.



**PONNAIYAH RAMAJAYAM INSTITUTE OF
SCIENCE & TECHNOLOGY (PRIST)**
Declared as DEEMED TO BE UNIVERSITY
U/s 3 of UGC Act, 1956

**SCHOOL OF COMMERCE AND MANAGEMENT
VALUE ADDED COURSE
DEPARTMENT OF COMMERCE
CERTIFICATE OF APPRECIATION**

This is to certify that Ms/Mr Ms Meega Reg.No 22 DICM9 D201 has

Completed the value added course on Certificate Course in GST
from 17/07/23 to 13/09/23 during the academic year of 2023 to 2024.

COURSE COORDINATOR

HOD

[Signature]

[Signature]

DEAN

[Signature]

Department of Commerce
Ponnaiyah Ramajayam Institute of
Science & Technology (PRIST),
Declared as DEEMED TO BE UNIVERSITY

School of Commerce and Management
Ponnaiyah Ramajayam Institute of
Science & Technology (PRIST),
THANJAVUR - 613 403.



**PONNAIYAH RAMAJAYAM INSTITUTE OF
SCIENCE & TECHNOLOGY (PRIST)**
Declared as DEEMED-TO-BE-UNIVERSITY
U/s 3 of UGC Act, 1956

**SCHOOL OF COMMERCE AND MANAGEMENT
VALUE ADDED COURSE
DEPARTMENT OF COMMERCE
CERTIFICATE OF APPRECIATION**

This is to certify that Ms/Mr J. Vijaya dhanashini Reg.No 2201C1920202 has

Completed the value added course on Certificate Course in GST
from 17/07/23 to 13/09/23 during the academic year of 2023 to 2024.

COURSE COORDINATOR

HOD

DEAN

Department of Commerce
Ponnaiyah Ramajayam Institute of
Science & Technology (PRIST),
Declared as DEEMED TO BE UNIVERSITY

School of Commerce and Management
Ponnaiyah Ramajayam Institute of
Science & Technology (PRIST)
THANJAVUR - 613 403.



**PONNAIYAH RAMAJAYAM INSTITUTE OF
SCIENCE & TECHNOLOGY (PRIST)**
Declared as DEEMED-TO-BE-UNIVERSITY
U/s 3 of UGC Act, 1956

**SCHOOL OF COMMERCE AND MANAGEMENT
VALUE ADDED COURSE
DEPARTMENT OF COMMERCE
CERTIFICATE OF APPRECIATION**

This is to certify that Ms/Mr A. N. Duveetha Reg.No 2201C1920023 has
Completed the value added course on Certificate Course in GST
from 17/07/23 to 13/09/23 during the academic year of 2023 to 2024.

[Signature]
COURSE COORDINATOR

[Signature]
HOD

[Signature]
DEAN

Department of Commerce
Ponnaiyah Ramajayam Institute of
Science & Technology (PRIST),
Declared as DEEMED TO BE UNIVERSITY

School of Commerce and Management
Ponnaiyah Ramajayam Institute of
Science & Technology (PRIST)
THANJAVUR - 613 403.



**PONNAIYAH RAMAJAYAM INSTITUTE OF
SCIENCE & TECHNOLOGY (PRIST)**
Declared as DEEMED TO BE UNIVERSITY
U/s 3 of UGC Act, 1956

**SCHOOL OF COMMERCE AND MANAGEMENT
VALUE ADDED COURSE
DEPARTMENT OF COMMERCE
CERTIFICATE OF APPRECIATION**

This is to certify that Ms/Mr R. Pavithra Reg.No 2201C1920204 has

Completed the value added course on Certificate Course in GST
from 17/07/23 to 13/09/23 during the academic year of 2023 to 2024.

COURSE COORDINATOR

HOD

HOD

DEAN

Department of Commerce
Ponnaiyah Ramajayam Institute of
Science & Technology (PRIST),
Declared as DEEMED TO BE UNIVERSITY

School of Commerce and Management
Ponnaiyah Ramajayam Institute of
Science & Technology (PRIST)
THANJAVUR - 613 403.



**PONNAIYAH RAMAJAYAM INSTITUTE OF
SCIENCE & TECHNOLOGY (PRIST)**

Declared as DEEMED-TO-BE-UNIVERSITY
U/s 3 of UGC Act, 1956

**SCHOOL OF COMMERCE AND MANAGEMENT
VALUE ADDED COURSE
DEPARTMENT OF COMMERCE
CERTIFICATE OF APPRECIATION**

This is to certify that Ms/Mr Mathavan, V Reg.No 2801CNG 20191 has

Completed the value added course on Certificate Course in O&ST
from 17/07/23 to 13/09/23 during the academic year of 2023 to 2024.

COURSE COORDINATOR

HOD

HOD

DEAN

DEAN

Department of Commerce
Ponnaiyah Ramajayam Institute of
Science & Technology (PRIST),
Declared as DEEMED TO BE UNIVERSITY

School of Commerce and Management
Ponnaiyah Ramajayam Institute of
Science & Technology (PRIST)
THANJAVUR - 613 403.



**PONNAIYAH RAMAJAYAM INSTITUTE OF
SCIENCE & TECHNOLOGY (PRIST)**
Declared as DEEMED-TO-BE UNIVERSITY
U/s 3 of UGC Act, 1956

**SCHOOL OF COMMERCE AND MANAGEMENT
VALUE ADDED COURSE
DEPARTMENT OF COMMERCE
CERTIFICATE OF APPRECIATION**

This is to certify that Ms/Mr Bharathiraj. K Reg.No 2301CMT20102 has

Completed the value added course on Certificate Course in GST
from 17/07/23 to 13/09/23 during the academic year of 2023 to 2024.

COURSE COORDINATOR

HOD

HOD

DEAN

DEAN

Department of Commerce
Ponnaiyah Ramajayam Institute of
Science & Technology (PRIST),
Declared as DEEMED TO BE UNIVERSITY

School of Commerce and Management
Ponnaiyah Ramajayam Institute of
Science & Technology (PRIST)
THANJAVUR - 613 403.



**PONNAIYAH RAMAJAYAM INSTITUTE OF
SCIENCE & TECHNOLOGY (PRIST)**

Declared as DEEMED TO BE UNIVERSITY
U/s 3 of UGC Act, 1956

**SCHOOL OF COMMERCE AND MANAGEMENT
VALUE ADDED COURSE
DEPARTMENT OF COMMERCE
CERTIFICATE OF APPRECIATION**

This is to certify that Ms/Mr S. Vijay Reg.No 2801C1920103 has

Completed the value added course on Certificate Course in GST
from 17/07/23 to 13/09/23 during the academic year of 2023 to 2024.

COURSE COORDINATOR

HOD

DEAN

Department of Commerce
Ponnaiyah Ramajayam Institute of
Science & Technology (PRIST),
Declared as DEEMED TO BE UNIVERSITY

School of Commerce and Management
Ponnaiyah Ramajayam Institute of
Science & Technology (PRIST)
THANJAVUR - 613 403.



**PONNAIYAH RAMAJAYAM INSTITUTE OF
SCIENCE & TECHNOLOGY (PRIST)**
Declared as DEEMED TO BE UNIVERSITY
U/s 3 of UGC Act, 1956

**SCHOOL OF COMMERCE AND MANAGEMENT
VALUE ADDED COURSE
DEPARTMENT OF COMMERCE
CERTIFICATE OF APPRECIATION**

This is to certify that Ms/Mr R. Aritha Kumar Reg.No 2301CM20104 has

Completed the value added course on Certificate Course in GST
from 17/07/23 to 13/09/23 during the academic year of 2023 to 2024.

[Signature]
COURSE COORDINATOR

[Signature]
HOD

[Signature]
DEAN

Department of Commerce
Ponnaiyah Ramajayam Institute of
Science & Technology (PRIST),
Declared as DEEMED TO BE UNIVERSITY

School of Commerce and Management
Ponnaiyah Ramajayam Institute of
Science & Technology (PRIST)
THANJAVUR - 613 403.



**PONNAIYAH RAMAJAYAM INSTITUTE OF
SCIENCE & TECHNOLOGY (PRIST)**

Declared as DEEMED-TO-BE-UNIVERSITY
U/s 3 of UGC Act, 1956

**SCHOOL OF COMMERCE AND MANAGEMENT
VALUE ADDED COURSE
DEPARTMENT OF COMMERCE
CERTIFICATE OF APPRECIATION**

This is to certify that Ms/Mr Ragul A Reg.No 2201BP10105 has

Completed the value added course on E-Filing of Income Tax (ET&TDS)
from 17/07/23 to 13/09/23 during the academic year of 2023 to 2024.

R. Govindarajan
COURSE COORDINATOR

R. Govindarajan
HOD

R. Govindarajan
DEAN

Department of Commerce
Ponnaiyah Ramajayam Institute of
Science & Technology (PRIST),
Declared as DEEMED TO BE UNIVERSITY

School of Commerce and Management
Ponnaiyah Ramajayam Institute of
Science & Technology (PRIST)
THANJAVUR - 613 403.



**PONNAIYAH RAMAJAYAM INSTITUTE OF
SCIENCE & TECHNOLOGY (PRIST)**

Declared as DEEMED-TO-BE-UNIVERSITY
U/s 3 of UGC Act, 1956

**SCHOOL OF COMMERCE AND MANAGEMENT
VALUE ADDED COURSE
DEPARTMENT OF COMMERCE
CERTIFICATE OF APPRECIATION**

This is to certify that Ms/Mr Dhanush. G Reg.No 2201BPI10104 has

Completed the value added course on E-filing of Income Tax (TDS)
from 17/07/23 to 13/09/23 during the academic year of 2023 to 2024.

COURSE COORDINATOR

HOD

DEAN

DEAN

Department of Commerce
Ponnaiyah Ramajayam Institute of
Science & Technology (PRIST),
Declared as DEEMED TO BE UNIVERSITY

School of Commerce and Management
Ponnaiyah Ramajayam Institute of
Science & Technology (PRIST)
THANJAVUR. 613 403.



**PONNAIYAH RAMAJAYAM INSTITUTE OF
SCIENCE & TECHNOLOGY (PRIST)**
Declared as DEEMED-TO-BE UNIVERSITY
U/s 3 of UGC Act, 1956

**SCHOOL OF COMMERCE AND MANAGEMENT
VALUE ADDED COURSE
DEPARTMENT OF COMMERCE
CERTIFICATE OF APPRECIATION**

This is to certify that Ms/Mr Arun. A Reg.No 222019P10103 has
Completed the value added course on F-Filling of Income Tax (TDS)
from 17/07/23 to 13/09/23 during the academic year of 2023 to 2024.

COURSE COORDINATOR

HOD

DEAN

Department of Commerce
Ponnaiyah Ramajayam Institute of
Science & Technology (PRIST),
Declared as DEEMED TO BE UNIVERSITY

School of Commerce and Management
Ponnaiyah Ramajayam Institute of
Science & Technology (PRIST)
THANJAVUR - 613 403.



**PONNAIYAH RAMAJAYAM INSTITUTE OF
SCIENCE & TECHNOLOGY (PRIST)**
Declared as DEEMED-TO-BE-UNIVERSITY
U/s 3 of UGC Act, 1956

**SCHOOL OF COMMERCE AND MANAGEMENT
VALUE ADDED COURSE
DEPARTMENT OF COMMERCE
CERTIFICATE OF APPRECIATION**

This is to certify that Ms/Mr Deepale. A Reg.No 2201AP10102 has

Completed the value added course on F-Filling of Income Tax (TPT & TDS)
from 17/07/23 to 13/09/23 during the academic year of 2023 to 2024.

COURSE COORDINATOR

HOD

[Signature]

[Signature]

DEAN

DEAN

[Signature]

Department of Commerce
Ponnaiyah Ramajayam Institute of
Science & Technology (PRIST),
Declared as DEEMED TO BE UNIVERSITY

School of Commerce and Management
Ponnaiyah Ramajayam Institute of
Science & Technology (PRIST)
THANJAVUR - 613 403.



**PONNAIYAH RAMAJAYAM INSTITUTE OF
SCIENCE & TECHNOLOGY (PRIST)**

Declared as DEEMED-TO-BE-UNIVERSITY
U/s 3 of UGC Act, 1956

**SCHOOL OF COMMERCE AND MANAGEMENT
VALUE ADDED COURSE
DEPARTMENT OF COMMERCE
CERTIFICATE OF APPRECIATION**

This is to certify that Ms/Mr Shamshara J Reg.No 2201AP10101 has

Completed the value added course on E-Filing of Income Tax (PRT & TDS)
from 17/07/23 to 13/09/23 during the academic year of 2023 to 2024.

COURSE COORDINATOR

HOD

DEAN

Department of Commerce
Ponnaiyah Ramajayam Institute of
Science & Technology (PRIST),
Declared as DEEMED TO BE UNIVERSITY

School of Commerce and Management
Ponnaiyah Ramajayam Institute of
Science & Technology (PRIST)
THANJAVUR - 613 403.



**PONNAIYAH RAMAJAYAM INSTITUTE OF
SCIENCE & TECHNOLOGY (PRIST)**

Declared as DEEMED-TO-BE-UNIVERSITY
U/s 3 of UGC Act, 1956

**SCHOOL OF COMMERCE AND MANAGEMENT
VALUE ADDED COURSE
DEPARTMENT OF COMMERCE
CERTIFICATE OF APPRECIATION**

This is to certify that Ms/Mr Hadan Ali. H Reg.No 2201AP10106 has

Completed the value added course on E - Filling of Income Tax (TITATS)
from 17/07/23 to 13/09/23 during the academic year of 2023 to 2024.

COURSE COORDINATOR

HOD

DEAN

Department of Commerce
Ponnaiyah Ramajayam Institute of
Science & Technology (PRIST),
Declared as DEEMED TO BE UNIVERSITY

School of Commerce and Management
Ponnaiyah Ramajayam Institute of
Science & Technology (PRIST)
THANJAVUR - 613 403.



**PONNAIYAH RAMAJAYAM INSTITUTE OF
SCIENCE & TECHNOLOGY (PRIST)**
Declared as DEEMED-TO-BE-UNIVERSITY
U/s 3 of UGC Act, 1956

**SCHOOL OF COMMERCE AND MANAGEMENT
VALUE ADDED COURSE
DEPARTMENT OF COMMERCE
CERTIFICATE OF APPRECIATION**

This is to certify that Ms/Mr GOKUL.S.P Reg.No 2201A110108 has

Completed the value added course on E-Filing of Income Tax [ITR 2 & TDS]
from 17/04/2023 to 13/09/2023 during the academic year of 2023 to 2024.

COURSE COORDINATOR

HOD

DEAN

DEAN

Department of Commerce
Ponnaiyah Ramajayam Institute of
Science & Technology (PRIST),
Declared as DEEMED TO BE UNIVERSITY

School of Commerce and Management
Ponnaiyah Ramajayam Institute of
Science & Technology (PRIST)
THANJAVUR-613 403.

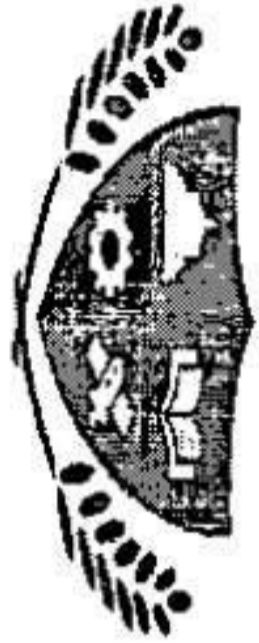

**PONNAIYAH RAMAJAYAM INSTITUTE OF
SCIENCE & TECHNOLOGY (PRIST)**

Declared as DEEMED-TO-BE-UNIVERSITY
U/s 3 of UGC Act, 1956

**SCHOOL OF COMMERCE AND MANAGEMENT
VALUE ADDED COURSE
DEPARTMENT OF COMMERCE
CERTIFICATE OF APPRECIATION**

This is to certify that Ms/Mr LYAPPAN.A Reg.No 221AP10107 has

Completed the value added course on E-filing of Income Tax [IT&TPT]
from 17/07/23 to 13/09/23 during the academic year of 2023 to 2024.

COURSE COORDINATOR

HOD

HOD

DEAN

DEAN

Department of Commerce
Ponnaiyah Ramajayam Institute of
Science & Technology (PRIST),
Declared as DEEMED TO BE UNIVERSITY

School of Commerce and Management
Ponnaiyah Ramajayam Institute of
Science & Technology (PRIST)
THANJAVUR - 613 403.



**PONNAIYAH RAMAJAYAM INSTITUTE OF
SCIENCE & TECHNOLOGY (PRIST)**
Declared as DEEMED-TO-BE UNIVERSITY
U/s 3 of UGC Act, 1956

**SCHOOL OF COMMERCE AND MANAGEMENT
VALUE ADDED COURSE
DEPARTMENT OF COMMERCE
CERTIFICATE OF APPRECIATION**

This is to certify that Ms/Mr NARESH.V Reg.No 2001AP10109 has
Completed the value added course on E Filing of Income Tax Returns
from 17/07/23 to 13/09/23 during the academic year of 2023 to 2024.

COURSE COORDINATOR

HOD

DEAN

Department of Commerce
Ponnaiyah Ramajayam Institute of
Science & Technology (PRIST),
Declared as DEEMED TO BE UNIVERSITY

School of Commerce and Management
Ponnaiyah Ramajayam Institute of
Science & Technology (PRIST),
THANJAVUR - 613 403.



**PONNAIYAH RAMAJAYAM INSTITUTE OF
SCIENCE & TECHNOLOGY (PRIST)**
Declared as DEEMED-TO-BE-UNIVERSITY
U/s 3 of UGC Act, 1956

**SCHOOL OF COMMERCE AND MANAGEMENT
VALUE ADDED COURSE
DEPARTMENT OF COMMERCE
CERTIFICATE OF APPRECIATION**

This is to certify that Ms/Mr NOTHAMED ARSHITH AJM Reg.No 2201PAP10110 has
Completed the value added course on E-Filing of Income Tax [ITR 1/2]
from 17/07/23 to 13/09/23 during the academic year of 2023 to 2024.

COURSE COORDINATOR

HOD

DEAN

Department of Commerce
Ponnaiyah Ramajayam Institute of
Science & Technology (PRIST),
Declared as DEEMED TO BE UNIVERSITY

School of Commerce and Management
Ponnaiyah Ramajayam Institute of
Science & Technology (PRIST)
THANJAVUR - 613 403.



**PONNAIYAH RAMAJAYAM INSTITUTE OF
SCIENCE & TECHNOLOGY (PRIST)**
Declared as DEEMED-TO-BE-UNIVERSITY
U/s 3 of UGC Act, 1956

**SCHOOL OF COMMERCE AND MANAGEMENT
VALUE ADDED COURSE
DEPARTMENT OF COMMERCE
CERTIFICATE OF APPRECIATION**

This is to certify that Ms/Mr PRAGADEESH H. R Reg.No 2201MPT0111 has
Completed the value added course on E-Filling of Invoice for IRT & TRST
from 17/07/23 to 13/09/23 during the academic year of 2023 to 2024.

COURSE COORDINATOR

HOD

DEAN

Department of Commerce
Ponnaiyah Ramajayam Institute of
Science & Technology (PRIST),
Declared as DEEMED TO BE UNIVERSITY

School of Commerce and Management
Ponnaiyah Ramajayam Institute of
Science & Technology (PRIST)
THANJAVUR - 613 403.

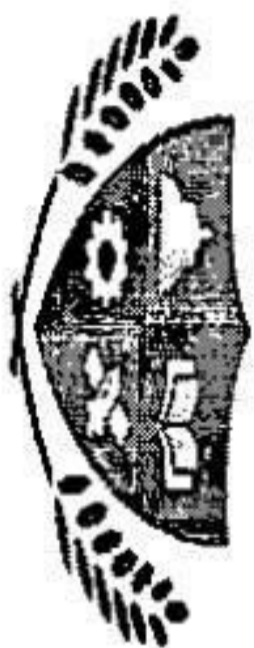

**PONNAIYAH RAMAJAYAM INSTITUTE OF
SCIENCE & TECHNOLOGY (PRIST)**
Declared as DEEMED-TO-BE-UNIVERSITY
U/s 3 of UGC Act, 1956

**SCHOOL OF COMMERCE AND MANAGEMENT
VALUE ADDED COURSE
DEPARTMENT OF COMMERCE
CERTIFICATE OF APPRECIATION**

This is to certify that Ms/Mr HARI GRANESH R Reg.No 22JA110112 has
Completed the value added course on E-Fallacy of Trade for IIT & TDS
from 11/07/23 to 13/09/23 during the academic year of 2023 to 2024.

COURSE COORDINATOR

HOD

DEAN

DEAN

Department of Commerce
Ponnaiyah Ramajayam Institute of
Science & Technology (PRIST),
Declared as DEEMED TO BE UNIVERSITY

School of Commerce and Management
Ponnaiyah Ramajayam Institute of
Science & Technology (PRIST)
THANJAVUR - 613 403.



**PONNAIYAH RAMAJAYAM INSTITUTE OF
SCIENCE & TECHNOLOGY (PRIST)**
Declared as DEEMED-TO-BE UNIVERSITY
U/s 3 of UGC Act, 1956

**SCHOOL OF COMMERCE AND MANAGEMENT
VALUE ADDED COURSE
DEPARTMENT OF COMMERCE
CERTIFICATE OF APPRECIATION**

This is to certify that Ms/Mr KARTHIKEYAN, M Reg.No 2201AP10113 has
Completed the value added course on E-filing of Income Tax [PART 1]
from 17/07/23 to 13/09/23 during the academic year of 2023 to 2024.

COURSE COORDINATOR

HOD

DEAN

Department of Commerce
Ponnaiyah Ramajayam Institute of
Science & Technology (PRIST),
Declared as DEEMED TO BE UNIVERSITY

School of Commerce and Management
Ponnaiyah Ramajayam Institute of
Science & Technology (PRIST)
THANJAVUR - 613 403.



**PONNAIYAH RAMAJAYAM INSTITUTE OF
SCIENCE & TECHNOLOGY (PRIST)**
Declared as DEEMED-TO-BE-UNIVERSITY
U/s 3 of UGC Act, 1956

**SCHOOL OF COMMERCE AND MANAGEMENT
VALUE ADDED COURSE
DEPARTMENT OF COMMERCE
CERTIFICATE OF APPRECIATION**

This is to certify that Ms/Mr RAJESH R Reg.No 2201AP10114 has
Completed the value added course on E-Filing of Income Tax [Practicals]
from 17/07/23 to 13/09/23 during the academic year of 2023 to 2024.

[Signature]
COURSE COORDINATOR

[Signature]
HOD

[Signature]
DEAN

Department of Commerce
Ponnaiyah Ramajayam Institute of
Science & Technology (PRIST),
Declared as DEEMED TO BE UNIVERSITY

School of Commerce and Management
Ponnaiyah Ramajayam Institute of
Science & Technology (PRIST),
THANJAVUR - 613 403.



**PONNAIYAH RAMAJAYAM INSTITUTE OF
SCIENCE & TECHNOLOGY (PRIST)**
Declared as DEEMED-TO-BE-UNIVERSITY
U/s 3 of UGC Act, 1956

**SCHOOL OF COMMERCE AND MANAGEMENT
VALUE ADDED COURSE
DEPARTMENT OF COMMERCE
CERTIFICATE OF APPRECIATION**

This is to certify that Ms/Mr ATHY. R Reg.No 2201AP0115 has

Completed the value added course on E-Filing of Income Tax [ET&TPT]
from 17/07/23 to 13/09/23 during the academic year of 2023 to 2024.

COURSE COORDINATOR

HOD

DEAN

DEAN

Department of Commerce
Ponnaiyah Ramajayam Institute of
Science & Technology (PRIST),
Declared as DEEMED TO BE UNIVERSITY

School of Commerce and Management
Ponnaiyah Ramajayam Institute of
Science & Technology (PRIST)
THANJAVUR - 613 403.



**PONNAIYAH RAMAJAYAM INSTITUTE OF
SCIENCE & TECHNOLOGY (PRIST)**
Declared as DEEMED TO BE UNIVERSITY
U/S 3 of UGC Act, 1956

**SCHOOL OF COMMERCE AND MANAGEMENT
VALUE ADDED COURSE
DEPARTMENT OF COMMERCE
CERTIFICATE OF APPRECIATION**

This is to certify that Ms/Mr RAMESH.P Reg.No 2201AP10116 has

Completed the value added course on E-Filing of Income Tax PRIST
from 17/07/23 to 15/09/23 during the academic year of 2023 to 2024.

COURSE COORDINATOR

HOD

DEAN

Department of Commerce
Ponnaiyah Ramajayam Institute of
Science & Technology (PRIST),
Declared as DEEMED TO BE UNIVERSITY

School of Commerce and Management
Ponnaiyah Ramajayam Institute of
Science & Technology (PRIST)
THANJAVUR - 613 403.



**PONNAIYAH RAMAJAYAM INSTITUTE OF
SCIENCE & TECHNOLOGY (PRIST)**
Declared as DEEMED-TO-BE UNIVERSITY
U/s 3 of UGC Act, 1956

**SCHOOL OF COMMERCE AND MANAGEMENT
VALUE ADDED COURSE
DEPARTMENT OF COMMERCE
CERTIFICATE OF APPRECIATION**

This is to certify that Ms/Mr NAGENDRA KUMAR.P Reg.No 2201A110117 has
Completed the value added course on E-Filing of Income Tax [107 & 103]
from _____ to _____ during the academic year of 2023 to 2024.

COURSE COORDINATOR

HOD

DEAN

Department of Commerce
Ponnaiyah Ramajayam Institute of
Science & Technology (PRIST),
Declared as DEEMED TO BE UNIVERSITY

School of Commerce and Management
Ponnaiyah Ramajayam Institute of
Science & Technology (PRIST)
THANJAVUR - 613 403.



**PONNAIYAH RAMAJAYAM INSTITUTE OF
SCIENCE & TECHNOLOGY (PRIST)**

Declared as DEEMED-TO-BE-UNIVERSITY
U/s 3 of UGC Act, 1956

**SCHOOL OF COMMERCE AND MANAGEMENT
VALUE ADDED COURSE
DEPARTMENT OF COMMERCE
CERTIFICATE OF APPRECIATION**

This is to certify that Ms/Mr APARISH KARKK Reg.No 2201MPL0118 has
Completed the value added course on E-filing of Income Tax [RT & TDS]
from 17/07/23 to 13/09/23 during the academic year of 2023 to 2024.

K. Srinivas
COURSE COORDINATOR
K. Srinivas
HOD
DEAN

Department of Commerce
Ponnaiyah Ramajayam Institute of
Science & Technology (PRIST),
Declared as DEEMED TO BE UNIVERSITY

School of Commerce and Management
Ponnaiyah Ramajayam Institute of
Science & Technology (PRIST)
THANJAVUR - 613 403.



**PONNAIYAH RAMAJAYAM INSTITUTE OF
SCIENCE & TECHNOLOGY (PRIST)**

Declared as DEEMED-TO-BE-UNIVERSITY
U/s 3 of UGC Act, 1956

**SCHOOL OF COMMERCE AND MANAGEMENT
VALUE ADDED COURSE
DEPARTMENT OF COMMERCE
CERTIFICATE OF APPRECIATION**

This is to certify that Ms/Mr MOHAMMED RYAZ Reg.No 2201AP10119 has

Completed the value added course on E-Filing of Income Tax [IT&TST]
from 11/10/23 to 13/03/24 during the academic year of 2023 to 2024.

COURSE COORDINATOR

HOD

DEAN

DEAN

Department of Commerce
Ponnaiyah Ramajayam Institute of
Science & Technology (PRIST),
Declared as DEEMED TO BE UNIVERSITY

School of Commerce and Management
Ponnaiyah Ramajayam Institute of
Science & Technology (PRIST)
THANJAVUR - 613 403.



**PONNAIYAH RAMAJAYAM INSTITUTE OF
SCIENCE & TECHNOLOGY (PRIST)**
Declared as DEEMED TO BE UNIVERSITY
U/s 3 of UGC Act, 1956

**SCHOOL OF COMMERCE AND MANAGEMENT
VALUE ADDED COURSE
DEPARTMENT OF COMMERCE
CERTIFICATE OF APPRECIATION**

This is to certify that Ms/Mr GIRIYON R. R. Reg.No 2201AP10201 has
Completed the value added course on E-Filing of Income Tax [STARTER]
from 17/07/23 to 13/09/23 during the academic year of 2023 to 2024.

COURSE COORDINATOR

HOD

[Signature]

[Signature]

DEAN

DEAN

[Signature]

Department of Commerce
Ponnaiyah Ramajayam Institute of
Science & Technology (PRIST),
Declared as DEEMED TO BE UNIVERSITY

School of Commerce and Management
Ponnaiyah Ramajayam Institute of
Science & Technology (PRIST)
THANJAVUR - 613 403.



PONNAIYAH RAMAJAYAM INSTITUTE OF SCIENCE & TECHNOLOGY (PRIST)

Declared as DEEMED-TO-BE UNIVERSITY
U/s 3 of UGC Act, 1956

**SCHOOL OF COMMERCE AND MANAGEMENT
VALUE ADDED COURSE
DEPARTMENT OF COMMERCE
CERTIFICATE OF APPRECIATION**

This is to certify that Ms/Mr GOKUL RAM.N Reg.No 2201AP10202 has

Completed the value added course on E-Filing of Income Tax [ITR:ITPS]
from 11/01/23 to 13/09/23 during the academic year of 2023 to 2024.

COURSE COORDINATOR

HOD

DEAN

DEAN

Department of Commerce
Ponnaiyah Ramajayam Institute of
Science & Technology (PRIST),
Declared as DEEMED TO BE UNIVERSITY

School of Commerce and Management
Ponnaiyah Ramajayam Institute of
Science & Technology (PRIST)
THANJAVUR - 513 403.



**PONNAIYAH RAMAJAYAM INSTITUTE OF
SCIENCE & TECHNOLOGY (PRIST)**
Declared as DEEMED TO BE UNIVERSITY
U/s 3 of UGC Act, 1956

**SCHOOL OF COMMERCE AND MANAGEMENT
VALUE ADDED COURSE
DEPARTMENT OF COMMERCE
CERTIFICATE OF APPRECIATION**

This is to certify that Ms/Mr MEENA. K Reg.No 2201AP10203 has
Completed the value added course on E-Filing of Income Tax [ITR2023]
from 17/07/23 to 19/09/23 during the academic year of 2023 to 2024.

COURSE COORDINATOR

HOD

DEAN

Department of Commerce
Ponnaiyah Ramajayam Institute of
Science & Technology (PRIST),
Declared as DEEMED TO BE UNIVERSITY

School of Commerce and Management
Ponnaiyah Ramajayam Institute of
Science & Technology (PRIST)
THANJAVUR - 613 403.



**PONNAIYAH RAMAJAYAM INSTITUTE OF
SCIENCE & TECHNOLOGY (PRIST)**

Declared as DEEMED-TO-BE-UNIVERSITY
U/s 3 of UGC Act, 1956

**SCHOOL OF COMMERCE AND MANAGEMENT
VALUE ADDED COURSE
DEPARTMENT OF COMMERCE
CERTIFICATE OF APPRECIATION**

This is to certify that Ms/Mr GRABHA PRIYA.D Reg.No 2201AP10204 has

Completed the value added course on E-Filling of Income tax [Taxes]
from 11/01/23 to 13/09/23 during the academic year of 2023 to 2024.

COURSE COORDINATOR

HOD

DEAN

DEAN

Department of Commerce
Ponnaiyah Ramajayam Institute of
Science & Technology (PRIST),
Declared as DEEMED TO BE UNIVERSITY

School of Commerce and Management
Ponnaiyah Ramajayam Institute of
Science & Technology (PRIST)
THANJAVUR - 613 403.



**PONNAIYAH RAMAJAYAM INSTITUTE OF
SCIENCE & TECHNOLOGY (PRIST)**

Declared as DEEMED-TO-BE-UNIVERSITY
U/s 3 of UGC Act, 1956

**SCHOOL OF COMMERCE AND MANAGEMENT
VALUE ADDED COURSE
DEPARTMENT OF COMMERCE
CERTIFICATE OF APPRECIATION**

This is to certify that Ms/Mr VIGNAYALAKSHMI.S Reg.No 2201AP10205 has
Completed the value added course on E-Filing of Income Tax Returns
from 17/07/23 to 13/09/23 during the academic year of 2023 to 2024.

COURSE COORDINATOR

HOD

DEAN

Department of Commerce
Ponnaiyah Ramajayam Institute of
Science & Technology (PRIST),
Declared as DEEMED TO BE UNIVERSITY

School of Commerce and Management
Ponnaiyah Ramajayam Institute of
Science & Technology (PRIST)
THANJAVUR - 613 403.



PONNAIYAH RAMAJAYAM INSTITUTE OF SCIENCE & TECHNOLOGY (PRIST)

Declared as DEEMED-TO-BE UNIVERSITY
U/s 3 of UGC Act, 1956

**SCHOOL OF COMMERCE AND MANAGEMENT
VALUE ADDED COURSE
DEPARTMENT OF COMMERCE
CERTIFICATE OF APPRECIATION**

This is to certify that Ms/Mr SRI SREVA'S Reg.No 2201AP10206 has
Completed the value added course on E-filing of Income Tax [TDS & TDS]
from 17/07/23 to 13/09/23 during the academic year of 2023 to 2024.

COURSE COORDINATOR

HOD

DEAN

DEAN

Department of Commerce
Ponnaiyah Ramajayam Institute of
Science & Technology (PRIST),
Declared as DEEMED TO BE UNIVERSITY

School of Commerce and Management
Ponnaiyah Ramajayam Institute of
Science & Technology (PRIST)
THANJAVUR - 613 403.

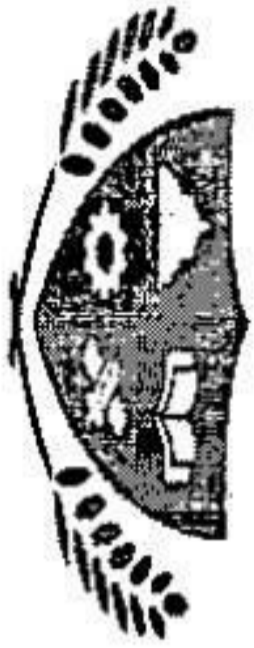

**PONNAIYAH RAMAJAYAM INSTITUTE OF
SCIENCE & TECHNOLOGY (PRIST)**
Declared as DEEMED-TO-BE-UNIVERSITY
U/s 3 of UGC Act, 1956

**SCHOOL OF COMMERCE AND MANAGEMENT
VALUE ADDED COURSE
DEPARTMENT OF COMMERCE
CERTIFICATE OF APPRECIATION**

This is to certify that Ms/Mr GWNA MARY-G Reg.No 2201AP10204 has
Completed the value added course on E-Filing of Income Tax [ITR2]
from 17/07/23 to 13/09/23 during the academic year of 2023 to 2024.

COURSE COORDINATOR

HOD

DEAN

DEAN

Department of Commerce
Ponnaiyah Ramajayam Institute of
Science & Technology (PRIST),
Declared as DEEMED TO BE UNIVERSITY

School of Commerce and Management
Ponnaiyah Ramajayam Institute of
Science & Technology (PRIST)
THANJAVUR - 613 403.



**PONNAIYAH RAMAJAYAM INSTITUTE OF
SCIENCE & TECHNOLOGY (PRIST)**

Declared as DEEMED-TO-BE-UNIVERSITY
U/s 3 of UGC Act, 1956

**SCHOOL OF COMMERCE AND MANAGEMENT
VALUE ADDED COURSE
DEPARTMENT OF COMMERCE
CERTIFICATE OF APPRECIATION**

This is to certify that Ms/Mr Sankar A Reg.No 2301CMT0126 has

Completed the value added course on Business Process Service in Insurance
from 28/01/24 to 14/03/24 during the academic year of 2023 to 2024.

COURSE COORDINATOR

HOD

DEAN

Department of Commerce
Ponnaiyah Ramajayam Institute of
Science & Technology (PRIST),
Declared as DEEMED TO BE UNIVERSITY

School of Commerce and Management
Ponnaiyah Ramajayam Institute of
Science & Technology (PRIST)
THANJAVUR - 613 403.

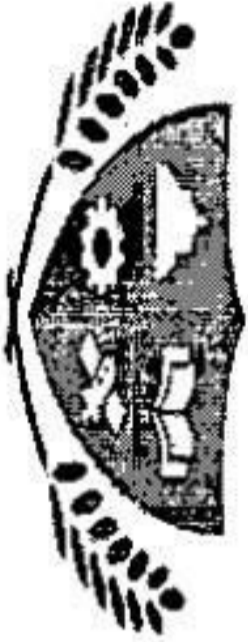

**PONNAIYAH RAMAJAYAM INSTITUTE OF
SCIENCE & TECHNOLOGY (PRIST)**

Declared as DEEMED-TO-BE-UNIVERSITY
U/s 3 of UGC Act, 1956

**SCHOOL OF COMMERCE AND MANAGEMENT
VALUE ADDED COURSE
DEPARTMENT OF COMMERCE
CERTIFICATE OF APPRECIATION**

This is to certify that Ms/Mr N. MOHAMED NIREBN Reg.No 2301CML101 has

Completed the value added course on CERTIFICATE COURSE IN BUSINESS PROCESS SERVICES

in duration from 23.01.24 to 14.03.24 during the academic year of 2023 to 2024.

K. S. S.
COURSE COORDINATOR

K. S. S.
HOD

K. S. S.
DEAN

Department of Commerce
Ponnaiyah Ramajayam Institute of
Science & Technology (PRIST),
Declared as DEEMED TO BE UNIVERSITY

School of Commerce and Management
Ponnaiyah Ramajayam Institute of
Science & Technology (PRIST)
THANJAVUR - 613 403.



**PONNAIYAH RAMAJAYAM INSTITUTE OF
SCIENCE & TECHNOLOGY (PRIST)**
Declared as DEEMED-TO-BE-UNIVERSITY
U/s 3 of UGC Act, 1956

**SCHOOL OF COMMERCE AND MANAGEMENT
VALUE ADDED COURSE
DEPARTMENT OF COMMERCE
CERTIFICATE OF APPRECIATION**

This is to certify that Ms/Mr S. SETHUPATHI Reg.No 2301CH10104 has

Completed the value added course on CERTIFICATE COURSE IN BUSINESS PROCESS SERVICES

WASURFACE from 23.01.24 to 14.03.24 during the academic year of 2023 to 2024.

COURSE COORDINATOR

HOD

HOD

DEAN

Department of Commerce
Ponnaiyah Ramajayam Institute of
Science & Technology (PRIST),
Declared as DEEMED TO BE UNIVERSITY

School of Commerce and Management
Ponnaiyah Ramajayam Institute of
Science & Technology (PRIST)
THANJAVUR - 613 403.



**PONNAIYAH RAMAJAYAM INSTITUTE OF
SCIENCE & TECHNOLOGY (PRIST)**
Declared as DEEMED-TO-BE UNIVERSITY
U/s 3 of UGC Act, 1956

**SCHOOL OF COMMERCE AND MANAGEMENT
VALUE ADDED COURSE
DEPARTMENT OF COMMERCE
CERTIFICATE OF APPRECIATION**

This is to certify that Ms/Mr A. HANITHA RAJMI Reg.No 22AELCM10105 has
Completed the value added course on CERTIFICATE COURSE IN BUSINESS PROCESS SERVICES IN
INSURANCE from 28.01.24 to 14.03.24 during the academic year of 2023 to 2024.

COURSE COORDINATOR

HOD

DEAN

Department of Commerce
Ponnaiyah Ramajayam Institute of
Science & Technology (PRIST),
Declared as DEEMED TO BE UNIVERSITY

School of Commerce and Management
Ponnaiyah Ramajayam Institute of
Science & Technology (PRIST)
THANJAVUR - 613 403.



**PONNAIYAH RAMAJAYAM INSTITUTE OF
SCIENCE & TECHNOLOGY (PRIST)**
Declared as DEEMED-TO-BE-UNIVERSITY
U/s 3 of UGC Act, 1956

**SCHOOL OF COMMERCE AND MANAGEMENT
VALUE ADDED COURSE
DEPARTMENT OF COMMERCE
CERTIFICATE OF APPRECIATION**

This is to certify that Ms/Mr K. PrasadESH Reg.No 2301CH10106 has

Completed the value added course on CERTIFICATE COURSE IN BUSINESS PROCESS SERVICES IN

INSURANCE from 23.01.24 to 14.03.24 during the academic year of 2023 to 2024.

K. Govindaraj
COURSE COORDINATOR

K. Govindaraj
HOD

K. Govindaraj
DEAN

Department of Commerce
Ponnaiyah Ramajayam Institute of
Science & Technology (PRIST),
Declared as DEEMED TO BE UNIVERSITY

School of Commerce and Management
Ponnaiyah Ramajayam Institute of
Science & Technology (PRIST),
THANJAVUR - 613 403.



**PONNAIYAH RAMAJAYAM INSTITUTE OF
SCIENCE & TECHNOLOGY (PRIST)**
Declared as DEEMED-TO-BE-UNIVERSITY
U/s 3 of UGC Act, 1956

**SCHOOL OF COMMERCE AND MANAGEMENT
VALUE ADDED COURSE
DEPARTMENT OF COMMERCE
CERTIFICATE OF APPRECIATION**

This is to certify that Ms/Mr S. PRASANA Reg.No 2301CH10104 has
Completed the value added course on CERTIFICATE COURSE IN BUSINESS SERVICES IN
INSURANCE from 28.01.24 to 14.03.24 during the academic year of 2023 to 2024.

[Signature]
COURSE COORDINATOR

HOD

[Signature]
DEAN

HOD

DEAN

Department of Commerce
Ponnaiyah Ramajayam Institute of
Science & Technology (PRIST),
Declared as DEEMED TO BE UNIVERSITY

School of Commerce and Management
Ponnaiyah Ramajayam Institute of
Science & Technology (PRIST)
THANJAVUR - 613 403.



**PONNAIYAH RAMAJAYAM INSTITUTE OF
SCIENCE & TECHNOLOGY (PRIST)**
Declared as DEEMED-TO-BE UNIVERSITY
U/s 3 of UGC Act, 1956

**SCHOOL OF COMMERCE AND MANAGEMENT
VALUE ADDED COURSE
DEPARTMENT OF COMMERCE
CERTIFICATE OF APPRECIATION**

This is to certify that Ms/Mr M. GURU Reg.No 23D1CH10108 has

Completed the value added course on CERTIFICATE COURSE IN BUSINESS SERVICES IN
INSURANCE from 23.01.24 to 14.03.24 during the academic year of 2023 to 2024.

COURSE COORDINATOR

HOD

DEAN

DEAN

Department of Commerce
Ponnaiyah Ramajayam Institute of
Science & Technology (PRIST),
Declared as DEEMED TO BE UNIVERSITY

School of Commerce and Management
Ponnaiyah Ramajayam Institute of
Science & Technology (PRIST)
THANJAVUR - 613 403.



**PONNAIYAH RAMAJAYAM INSTITUTE OF
SCIENCE & TECHNOLOGY (PRIST)**

Declared as DEEMED-TO-BE UNIVERSITY
U/s 3 of UGC Act, 1956

**SCHOOL OF COMMERCE AND MANAGEMENT
VALUE ADDED COURSE
DEPARTMENT OF COMMERCE
CERTIFICATE OF APPRECIATION**

This is to certify that Ms/Mr S. SITHAS AHAMED Reg.No 23012010109 has

Completed the value added course on CERTIFICATE COURSE IN BUSINESS PROCESS SERVICES IN
INSURANCE from 23.01.24 to 14.03.24 during the academic year of 2023 to 2024.

COURSE COORDINATOR

HOD

HOD

DEAN

DEAN

Department of Commerce
Ponnaiyah Ramajayam Institute of
Science & Technology (PRIST),
Declared as DEEMED TO BE UNIVERSITY

School of Commerce and Management
Ponnaiyah Ramajayam Institute of
Science & Technology (PRIST)
THANJAVUR - 613 403.



**PONNAIYAH RAMAJAYAM INSTITUTE OF
SCIENCE & TECHNOLOGY (PRIST)**

Declared as DEEMED-TO-BE-UNIVERSITY
U/s 3 of UGC Act, 1956

**SCHOOL OF COMMERCE AND MANAGEMENT
VALUE ADDED COURSE
DEPARTMENT OF COMMERCE
CERTIFICATE OF APPRECIATION**

This is to certify that Ms/Mr A. JESTINPUSHPERATH Reg.No 2301CH12113 has

Completed the value added course on CERTIFICATE COURSE IN BUSINESS SERVICES IN
INSURANCE from 23.01.24 to 14.03.24 during the academic year of 2023 to 2024.

COURSE COORDINATOR

HOD

DEAN

Department of Commerce
Ponnaiyah Ramajayam Institute of
Science & Technology (PRIST),
Declared as DEEMED TO BE UNIVERSITY

School of Commerce and Management
Ponnaiyah Ramajayam Institute of
Science & Technology (PRIST)
THANJAVUR - 613 403.



**PONNAIYAH RAMAJAYAM INSTITUTE OF
SCIENCE & TECHNOLOGY (PRIST)**
Declared as DEEMED TO BE UNIVERSITY
U/s 3 of UGC Act, 1956

**SCHOOL OF COMMERCE AND MANAGEMENT
VALUE ADDED COURSE
DEPARTMENT OF COMMERCE
CERTIFICATE OF APPRECIATION**

This is to certify that Ms/Mr K. JAYAPRASAN Reg.No 23a1cml011011 has
Completed the value added course on CERTIFICATE COURSE IN ROUTINELY PROCESS SERVICES IN
INSURANCE from 23.01.24 to 14.03.24 during the academic year of 2023 to 2024.

COURSE COORDINATOR

HOD

DEAN

Department of Commerce
Ponnaiyah Ramajayam Institute of
Science & Technology (PRIST),
Declared as DEEMED TO BE UNIVERSITY

School of Commerce and Management
Ponnaiyah Ramajayam Institute of
Science & Technology (PRIST)
THANJAVUR - 613 403.



**PONNAIYAH RAMAJAYAM INSTITUTE OF
SCIENCE & TECHNOLOGY (PRIST)**

Declared as DEEMED TO BE UNIVERSITY
U/s 3 of UGC Act, 1956

**SCHOOL OF COMMERCE AND MANAGEMENT
VALUE ADDED COURSE
DEPARTMENT OF COMMERCE
CERTIFICATE OF APPRECIATION**

This is to certify that Ms/Mr D. SARAVARISAN Reg.No 2301CM10115 has

Completed the value added course on CERTIFICATE COURSE IN BUYER'S SERVICES
IN SEPANE from 23.01.24 to 14.03.24 during the academic year of 2023 to 2024.

COURSE COORDINATOR

HOD

HOD

DEAN

DEAN

Department of Commerce
Ponnaiyah Ramajayam Institute of
Science & Technology (PRIST),
Declared as DEEMED TO BE UNIVERSITY

School of Commerce and Management
Ponnaiyah Ramajayam Institute of
Science & Technology (PRIST)
THANJAVUR - 613 403.



**PONNAIYAH RAMAJAYAM INSTITUTE OF
SCIENCE & TECHNOLOGY (PRIST)**

Declared as DEEMED TO BE UNIVERSITY
U/s 3 of UGC Act, 1956

**SCHOOL OF COMMERCE AND MANAGEMENT
VALUE ADDED COURSE
DEPARTMENT OF COMMERCE
CERTIFICATE OF APPRECIATION**

This is to certify that Ms/Mr S. KATHIRVELAN Reg.No 23SC11016 has

Completed the value added course on CERTIFICATE COURSE IN BUSINESS PROCESS SERVICES
IN INDUSTRANCE from 23.01.24 to 14.03.24 during the academic year of 2023 to 2024.

COURSE COORDINATOR

HOD

HOD

DEAN

DEAN

Department of Commerce
Ponnaiyah Ramajayam Institute of
Science & Technology (PRIST),
Declared as DEEMED TO BE UNIVERSITY

School of Commerce and Management
Ponnaiyah Ramajayam Institute of
Science & Technology (PRIST)
THANJAVUR - 613 403.



**PONNAIYAH RAMAJAYAM INSTITUTE OF
SCIENCE & TECHNOLOGY (PRIST)**

Declared as DEEMED-TO-BE-UNIVERSITY
U/s 3 of UGC Act, 1956

**SCHOOL OF COMMERCE AND MANAGEMENT
VALUE ADDED COURSE
DEPARTMENT OF COMMERCE
CERTIFICATE OF APPRECIATION**

This is to certify that Ms/Mr P. SUDHARSHAN Reg.No 23AICM15117 has

Completed the value added course on CERTIFICATE COURSE IN BUSINESS PROCESS SERVICES IN
INDUSTRY from 23.01.14 to 14.03.24 during the academic year of 2023 to 2024.

COURSE COORDINATOR

HOD

DEAN

Department of Commerce
Ponnaiyah Ramajayam Institute of
Science & Technology (PRIST),
Declared as DEEMED TO BE UNIVERSITY

School of Commerce and Management
Ponnaiyah Ramajayam Institute of
Science & Technology (PRIST)
THANJAVUR - 613 403.



**PONNAIYAH RAMAJAYAM INSTITUTE OF
SCIENCE & TECHNOLOGY (PRIST)**
Declared as DEEMED-TO-BE-UNIVERSITY
U/s 3 of UGC Act, 1956

**SCHOOL OF COMMERCE AND MANAGEMENT
VALUE ADDED COURSE
DEPARTMENT OF COMMERCE
CERTIFICATE OF APPRECIATION**

This is to certify that Ms/Mr K. MULLAN Reg.No 23BCE10120 has

Completed the value added course on CERTIFICATE COURSE IN BUSINESS PROCESS SERVICES IN
INSURANCE from 23.01.24 to 14.03.24 during the academic year of 2023 to 2024.

K. Govindaraj
COURSE COORDINATOR

HOD

K. Govindaraj
DEAN

HOD

DEAN

Department of Commerce
Ponnaiyah Ramajayam Institute of
Science & Technology (PRIST),
Declared as DEEMED TO BE UNIVERSITY

School of Commerce and Management
Ponnaiyah Ramajayam Institute of
Science & Technology (PRIST)
THANJAVUR - 613 403.

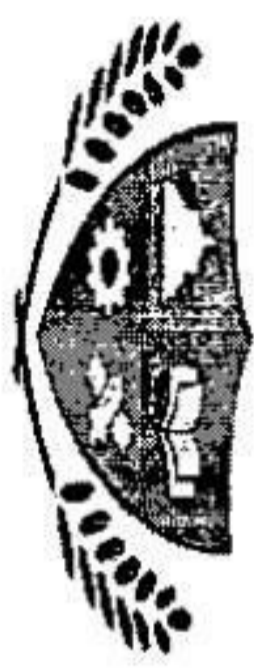

**PONNAIYAH RAMAJAYAM INSTITUTE OF
SCIENCE & TECHNOLOGY (PRIST)**
Declared as DEEMED-TO-BE-UNIVERSITY
U/s 3 of UGC Act, 1956

**SCHOOL OF COMMERCE AND MANAGEMENT
VALUE ADDED COURSE
DEPARTMENT OF COMMERCE
CERTIFICATE OF APPRECIATION**

This is to certify that Ms/Mr S. PRASANNA Reg.No 2301CH10121 has

Completed the value added course on CERTIFICATE COURSE IN BUSINESS PROCESS SERVICES IN
INSURANCE from 23.01.24 to 14.03.24 during the academic year of 2023 to 2024.

COURSE COORDINATOR

HOD

DEAN

Department of Commerce
Ponnaiyah Ramajayam Institute of
Science & Technology (PRIST),
Declared as DEEMED TO BE UNIVERSITY

School of Commerce and Management
Ponnaiyah Ramajayam Institute of
Science & Technology (PRIST)
THANJAVUR - 613 403.



**PONNAIYAH RAMAJAYAM INSTITUTE OF
SCIENCE & TECHNOLOGY (PRIST)**
Declared as DEEMED-TO-BE-UNIVERSITY
U/s 3 of UGC Act, 1956

**SCHOOL OF COMMERCE AND MANAGEMENT
VALUE ADDED COURSE
DEPARTMENT OF COMMERCE
CERTIFICATE OF APPRECIATION**

This is to certify that Ms/Mr R. NINESHYOMER Reg.No 2301CH12122 has

Completed the value added course on CERTIFICATE COURSE IN BUSINESS PROCESS ANALYSIS IN
MANAGEMENT from 23.01.24 to 14.03.24 during the academic year of 2023 to 2024.

K. Govindaraj
COURSE COORDINATOR

HOD

HOD

K. Govindaraj
DEAN

DEAN

Department of Commerce
Ponnaiyah Ramajayam Institute of
Science & Technology (PRIST),
Declared as DEEMED TO BE UNIVERSITY

School of Commerce and Management
Ponnaiyah Ramajayam Institute of
Science & Technology (PRIST)
THANJAVUR - 613 403.



**PONNAIYAH RAMAJAYAM INSTITUTE OF
SCIENCE & TECHNOLOGY (PRIST)**
Declared as DEEMED-TO-BE-UNIVERSITY
U/s 3 of UGC Act, 1956

**SCHOOL OF COMMERCE AND MANAGEMENT
VALUE ADDED COURSE
DEPARTMENT OF COMMERCE
CERTIFICATE OF APPRECIATION**

This is to certify that Ms/Mr Mohamed Shahidh. S Reg.No 2301CM10123 has
Completed the value added course on Business Process Services in Insurance
from 28/01/24 to 14/03/24 during the academic year of 2023 to 2024.

COURSE COORDINATOR

HOD

HOD

DEAN

DEAN

Department of Commerce
Ponnaiyah Ramajayam Institute of
Science & Technology (PRIST),
Declared as DEEMED TO BE UNIVERSITY

School of Commerce and Management
Ponnaiyah Ramajayam Institute of
Science & Technology (PRIST)
THANJAVUR - 613 403.

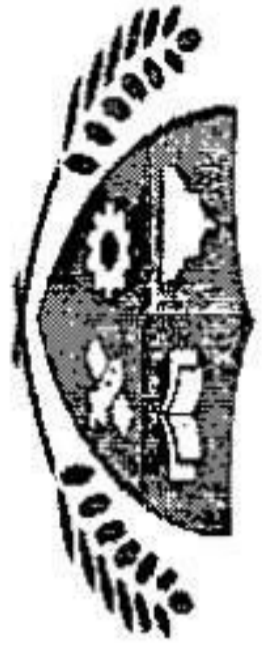

**PONNAIYAH RAMAJAYAM INSTITUTE OF
SCIENCE & TECHNOLOGY (PRIST)**
Declared as DEEMED-TO-BE-UNIVERSITY
U/s 3 of UGC Act, 1956

**SCHOOL OF COMMERCE AND MANAGEMENT
VALUE ADDED COURSE
DEPARTMENT OF COMMERCE
CERTIFICATE OF APPRECIATION**

This is to certify that Ms/Mr Annaya A Reg.No 2801CM10124 has

Completed the value added course on Business Process Services in Insurance
from 28/01/24 to 14/03/24 during the academic year of 2023 to 2024.

COURSE COORDINATOR

HOD

DEAN

Department of Commerce
Ponnaiyah Ramajayam Institute of
Science & Technology (PRIST),
Declared as DEEMED TO BE UNIVERSITY

School of Commerce and Management
Ponnaiyah Ramajayam Institute of
Science & Technology (PRIST)
THANJAVUR - 613 403.



**PONNAIYAH RAMAJAYAM INSTITUTE OF
SCIENCE & TECHNOLOGY (PRIST)**
Declared as DEEMED-TO-BE-UNIVERSITY
U/s 3 of UGC Act, 1956

**SCHOOL OF COMMERCE AND MANAGEMENT
VALUE ADDED COURSE
DEPARTMENT OF COMMERCE
CERTIFICATE OF APPRECIATION**

This is to certify that Ms/Mr Jayasriya . P Reg.No 2301CM10125 has
Completed the value added course on Business Process Services in Insurance
from 28/01/24 to 14/03/24 during the academic year of 2023 to 2024.

COURSE COORDINATOR

HOD

DEAN

Department of Commerce
Ponnaiyah Ramajayam Institute of
Science & Technology (PRIST),
Declared as DEEMED TO BE UNIVERSITY

School of Commerce and Management
Ponnaiyah Ramajayam Institute of
Science & Technology (PRIST)
THANJAVUR - 613 403.



**PONNAIYAH RAMAJAYAM INSTITUTE OF
SCIENCE & TECHNOLOGY (PRIST)**
Declared as DEEMED TO BE UNIVERSITY
U/s 3 of UGC Act, 1956

**SCHOOL OF COMMERCE AND MANAGEMENT
VALUE ADDED COURSE
DEPARTMENT OF COMMERCE
CERTIFICATE OF APPRECIATION**

This is to certify that Ms/Mr Navon Kumar . k Reg.No 2301CM10134 has
Completed the value added course on Business Process Services In Insurance
from 23/01/24 to 14/03/24 during the academic year of 2023 to 2024.

COURSE COORDINATOR

HOD

DEAN

Department of Commerce
Ponnaiyah Ramajayam Institute of
Science & Technology (PRIST),
Declared as DEEMED TO BE UNIVERSITY

School of Commerce and Management
Ponnaiyah Ramajayam Institute of
Science & Technology (PRIST)
THANJAVUR - 613 403.



**PONNAIYAH RAMAJAYAM INSTITUTE OF
SCIENCE & TECHNOLOGY (PRIST)**
Declared as DEEMED-TO-BE UNIVERSITY
U/s 3 of UGC Act, 1956

**SCHOOL OF COMMERCE AND MANAGEMENT
VALUE ADDED COURSE
DEPARTMENT OF COMMERCE
CERTIFICATE OF APPRECIATION**

This is to certify that Ms/Mr Tamil Selvan V Reg.No 2301C0410132 has
Completed the value added course on Business Process Service in Tourism
from 23/01/24 to 14/03/24 during the academic year of 2023 to 2024.

COURSE COORDINATOR

HOD

DEAN

Department of Commerce
Ponnaiyah Ramajayam Institute of
Science & Technology (PRIST),
Declared as DEEMED TO BE UNIVERSITY

School of Commerce and Management
Ponnaiyah Ramajayam Institute of
Science & Technology (PRIST)
THANJAVUR - 613 403.



**PONNAIYAH RAMAJAYAM INSTITUTE OF
SCIENCE & TECHNOLOGY (PRIST)**

Declared as DEEMED-TO-BE-UNIVERSITY
U/s 3 of UGC Act, 1956

**SCHOOL OF COMMERCE AND MANAGEMENT
VALUE ADDED COURSE
DEPARTMENT OF COMMERCE
CERTIFICATE OF APPRECIATION**

This is to certify that Ms/Mr Mohamed Rasmin. B Reg.No 2301CM10129 has

Completed the value added course on Business Process Service in Insurance
from 23/08/24 to 14/08/24 during the academic year of 2023 to 2024.

COURSE COORDINATOR

HOD

HOD

DEAN

DEAN

Department of Commerce
Ponnaiyah Ramajayam Institute of
Science & Technology (PRIST),
Declared as DEEMED TO BE UNIVERSITY

School of Commerce and Management
Ponnaiyah Ramajayam Institute of
Science & Technology (PRIST)
THANJAVUR - 613 403.

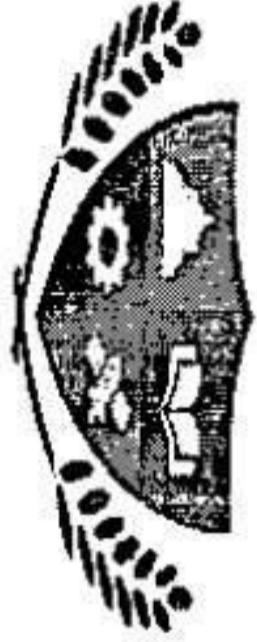

**PONNAIYAH RAMAJAYAM INSTITUTE OF
SCIENCE & TECHNOLOGY (PRIST)**

Declared as DEEMED-TO-BE UNIVERSITY
U/s 3 of UGC Act, 1956

**SCHOOL OF COMMERCE AND MANAGEMENT
VALUE ADDED COURSE
DEPARTMENT OF COMMERCE
CERTIFICATE OF APPRECIATION**

This is to certify that Ms/Mr Ragul. A Reg.No 2301CM10128 has

Completed the value added course on Business Process Service in Insurance
from 23/01/24 to 14/08/24 during the academic year of 2023 to 2024.

COURSE COORDINATOR

HOD

HOD

DEAN

DEAN

Department of Commerce
Ponnaiyah Ramajayam Institute of
Science & Technology (PRIST),
Declared as DEEMED TO BE UNIVERSITY

School of Commerce and Management
Ponnaiyah Ramajayam Institute of
Science & Technology (PRIST)
THANJAVUR - 613 403.



**PONNAIYAH RAMAJAYAM INSTITUTE OF
SCIENCE & TECHNOLOGY (PRIST)**
Declared as DEEMED-TO-BE UNIVERSITY
U/s 3 of UGC Act, 1956

**SCHOOL OF COMMERCE AND MANAGEMENT
VALUE ADDED COURSE
DEPARTMENT OF COMMERCE
CERTIFICATE OF APPRECIATION**

This is to certify that Ms/Mr Navin K Reg.No 2301CN10127 has
Completed the value added course on Business Process Service in Insurance
from 23/01/24 to 14/03/24 during the academic year of 2023 to 2024.

COURSE COORDINATOR

HOD

DEAN

Department of Commerce
Ponnaiyah Ramajayam Institute of
Science & Technology (PRIST),
Declared as DEEMED TO BE UNIVERSITY

School of Commerce and Management
Ponnaiyah Ramajayam Institute of
Science & Technology (PRIST)
THANJAVUR - 613 403.



**PONNAIYAH RAMAJAYAM INSTITUTE OF
SCIENCE & TECHNOLOGY (PRIST)**
Declared as DEEMED-TO-BE-UNIVERSITY
U/s 3 of UGC Act, 1956

**SCHOOL OF COMMERCE AND MANAGEMENT
VALUE ADDED COURSE
DEPARTMENT OF COMMERCE
CERTIFICATE OF APPRECIATION**

This is to certify that Ms/Mr Manoj Kumar K Reg.No 2301CMT16135 has
Completed the value added course on Business Process Service in Insurance
from 28/01/24 to 14/03/24 during the academic year of 2023 to 2024.

COURSE COORDINATOR

HOD

DEAN

Department of Commerce
Ponnaiyah Ramajayam Institute of
Science & Technology (PRIST),
Declared as DEEMED TO BE UNIVERSITY

School of Commerce and Management
Ponnaiyah Ramajayam Institute of
Science & Technology (PRIST)
THANJAVUR - 613 403.



**PONNAIYAH RAMAJAYAM INSTITUTE OF
SCIENCE & TECHNOLOGY (PRIST)**

Declared as DEEMED-TO-BE-UNIVERSITY
U/s 3 of UGC Act, 1956

**SCHOOL OF COMMERCE AND MANAGEMENT
VALUE ADDED COURSE
DEPARTMENT OF COMMERCE
CERTIFICATE OF APPRECIATION**

This is to certify that Ms/Mr Vinathini . I Reg.No 22BICM10250 has

Completed the value added course on Mutual Fund operations
from 17/07/23 to 13/09/23 during the academic year of 2023 to 2024.

[Signature]
COURSE COORDINATOR

[Signature]
HOD

[Signature]
DEAN

Department of Commerce
Ponnaiyah Ramajayam Institute of
Science & Technology (PRIST),
Declared as DEEMED TO BE UNIVERSITY

School of Commerce and Management
Ponnaiyah Ramajayam Institute of
Science & Technology (PRIST)
THANJAVUR - 613 403.



**PONNAIYAH RAMAJAYAM INSTITUTE OF
SCIENCE & TECHNOLOGY (PRIST)**
Declared as DEEMED TO BE UNIVERSITY
U/s 3 of UGC Act, 1956

**SCHOOL OF COMMERCE AND MANAGEMENT
VALUE ADDED COURSE
DEPARTMENT OF COMMERCE
CERTIFICATE OF APPRECIATION**

This is to certify that Ms/Mr V. Keerthivasan Reg.No 2101APP10131 has
Completed the value added course on Intellectual Property Rights
from 17/07/23 to 13/09/23 during the academic year of 2023 to 2024.

COURSE COORDINATOR

HOD

DEAN

Department of Commerce
Ponnaiyah Ramajayam Institute of
Science & Technology (PRIST),
Declared as DEEMED TO BE UNIVERSITY

School of Commerce and Management
Ponnaiyah Ramajayam Institute of
Science & Technology (PRIST)
THANJAVUR - 613 403.



**PONNAIYAH RAMAJAYAM INSTITUTE OF
SCIENCE & TECHNOLOGY (PRIST)**

Declared as DEEMED-TO-BE UNIVERSITY
U/s 3 of UGC Act, 1956

**SCHOOL OF COMMERCE AND MANAGEMENT
VALUE ADDED COURSE
DEPARTMENT OF COMMERCE
CERTIFICATE OF APPRECIATION**

This is to certify that Ms/Mr R. DEEPAK

Reg.No 2301AP10101 has

Completed the value added course on CERTIFICATE COURSE IN SALES FORCE BUSINESS ADMINISTRATION
SPECIALITY from 23.01.24 to 14.03.24 during the academic year of 2023 to 2024.

COURSE COORDINATOR

HOD

DEAN

DEAN

Department of Commerce
Ponnaiyah Ramajayam Institute of
Science & Technology (PRIST),
Declared as DEEMED TO BE UNIVERSITY

School of Commerce and Management
Ponnaiyah Ramajayam Institute of
Science & Technology (PRIST)
THANJAVUR - 613 403.



**PONNAIYAH RAMAJAYAM INSTITUTE OF
SCIENCE & TECHNOLOGY (PRIST)**

Declared as DEEMED TO BE UNIVERSITY
U/s 3 of UGC Act, 1956

**SCHOOL OF COMMERCE AND MANAGEMENT
VALUE ADDED COURSE
DEPARTMENT OF COMMERCE
CERTIFICATE OF APPRECIATION**

This is to certify that Ms/Mr R Mahabalan Reg.No 2201CM20101 has

Completed the value added course on Certificate Course in GST
from 11/07/23 to 13/09/23 during the academic year of 2023 to 2024.

COURSE COORDINATOR

HOD

DEAN

Department of Commerce
Ponnaiyah Ramajayam Institute of
Science & Technology (PRIST),
Declared as DEEMED TO BE UNIVERSITY

School of Commerce and Management
Ponnaiyah Ramajayam Institute of
Science & Technology (PRIST)
THANJAVUR - 613 403.



**PONNAIYAH RAMAJAYAM INSTITUTE OF
SCIENCE & TECHNOLOGY (PRIST)**
Declared as DEEMED-TO-BE UNIVERSITY
U/s 3 of UGC Act, 1956

**SCHOOL OF COMMERCE AND MANAGEMENT
VALUE ADDED COURSE
DEPARTMENT OF COMMERCE
CERTIFICATE OF APPRECIATION**

This is to certify that Ms/Mr P. Rajesh Reg.No 2201CMT20102 has

Completed the value added course on Certificate Course in GST
from 17/07/23 to 13/09/23 during the academic year of 2023 to 2024.

COURSE COORDINATOR

HOD

DEAN

DEAN

Department of Commerce
Ponnaiyah Ramajayam Institute of
Science & Technology (PRIST),
Declared as DEEMED TO BE UNIVERSITY

School of Commerce and Management
Ponnaiyah Ramajayam Institute of
Science & Technology (PRIST)
THANJAVUR - 613 403.



**PONNAIYAH RAMAJAYAM INSTITUTE OF
SCIENCE & TECHNOLOGY (PRIST)**
Declared as DEEMED TO-BE-UNIVERSITY
U/s 3 of UGC Act, 1956

**SCHOOL OF COMMERCE AND MANAGEMENT
VALUE ADDED COURSE
DEPARTMENT OF COMMERCE
CERTIFICATE OF APPRECIATION**

This is to certify that Ms/Mr M. Prakash Reg.No 2201CN20103 has

Completed the value added course on Certificate Course in GST
from 17/07/23 to 13/09/23 during the academic year of 2023 to 2024.

COURSE COORDINATOR

HOD

DEAN

DEAN

Department of Commerce
Ponnaiyah Ramajayam Institute of
Science & Technology (PRIST),
Declared as DEEMED TO BE UNIVERSITY

School of Commerce and Management
Ponnaiyah Ramajayam Institute of
Science & Technology (PRIST)
THANJAVUR - 613 403.



**PONNAIYAH RAMAJAYAM INSTITUTE OF
SCIENCE & TECHNOLOGY (PRIST)**
Declared as DEEMED-TO-BE UNIVERSITY
U/s 3 of UGC Act, 1956

**SCHOOL OF COMMERCE AND MANAGEMENT
VALUE ADDED COURSE
DEPARTMENT OF COMMERCE
CERTIFICATE OF APPRECIATION**

This is to certify that Ms/Mr K. Madhanay Reg.No 2201C M 20104 has

Completed the value added course on Certificate Course in GST
from 17/07/23 to 13/09/23 during the academic year of 2023 to 2024.

COURSE COORDINATOR

HOD

DEAN

DEAN

Department of Commerce
Ponnaiyah Ramajayam Institute of
Science & Technology (PRIST),
Declared as DEEMED TO BE UNIVERSITY

School of Commerce and Management
Ponnaiyah Ramajayam Institute of
Science & Technology (PRIST)
THANJAVUR - 613 403.

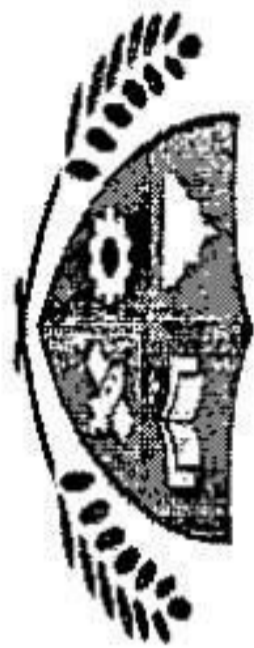

**PONNAIYAH RAMAJAYAM INSTITUTE OF
SCIENCE & TECHNOLOGY (PRIST)**
Declared as DEEMED-TO-BE-UNIVERSITY
U/s 3 of UGC Act, 1956

**SCHOOL OF COMMERCE AND MANAGEMENT
VALUE ADDED COURSE
DEPARTMENT OF COMMERCE
CERTIFICATE OF APPRECIATION**

This is to certify that Ms/Mr Ajayraj S Reg.No 2201CM20105 has
Completed the value added course on Certificate Course in GST
from 17/07/23 to 13/09/23 during the academic year of 2023 to 2024.

COURSE COORDINATOR

HOD

DEAN

Department of Commerce
Ponnaiyah Ramajayam Institute of
Science & Technology (PRIST),
Declared as DEEMED TO BE UNIVERSITY

School of Commerce and Management
Ponnaiyah Ramajayam Institute of
Science & Technology (PRIST)
THANJAVUR - 613 403.



**PONNAIYAH RAMAJAYAM INSTITUTE OF
SCIENCE & TECHNOLOGY (PRIST)**

Declared as DEEMED-TO-BE-UNIVERSITY
U/s 3 of UGC Act, 1956

**SCHOOL OF COMMERCE AND MANAGEMENT
VALUE ADDED COURSE
DEPARTMENT OF COMMERCE
CERTIFICATE OF APPRECIATION**

This is to certify that Ms/Mr Ajeetha S Reg.No 2201CNG20106has

Completed the value added course on Certificate Course in GST
from 17/07/23 to 13/09/23 during the academic year of 2023 to 2024.

COURSE COORDINATOR

HOD

DEAN

Department of Commerce
Ponnaiyah Ramajayam Institute of
Science & Technology (PRIST),
Declared as DEEMED TO BE UNIVERSITY

School of Commerce and Management
Ponnaiyah Ramajayam Institute of
Science & Technology (PRIST)
THANJAVUR - 613 403.



**PONNAIYAH RAMAJAYAM INSTITUTE OF
SCIENCE & TECHNOLOGY (PRIST)**

Declared as DEEMED-TO-BE-UNIVERSITY
U/s 3 of UGC Act, 1956

**SCHOOL OF COMMERCE AND MANAGEMENT
VALUE ADDED COURSE
DEPARTMENT OF COMMERCE
CERTIFICATE OF APPRECIATION**

This is to certify that Ms/Mr S. Malathi Reg.No 2201CN20107 has

Completed the value added course on Certificate Course in O&T
from 17/07/23 to 13/09/23 during the academic year of 2023 to 2024.

COURSE COORDINATOR

HOD

DEAN

Department of Commerce
Ponnaiyah Ramajayam Institute of
Science & Technology (PRIST),
Declared as DEEMED TO BE UNIVERSITY

School of Commerce and Management
Ponnaiyah Ramajayam Institute of
Science & Technology (PRIST)
THANJAVUR - 613 403.

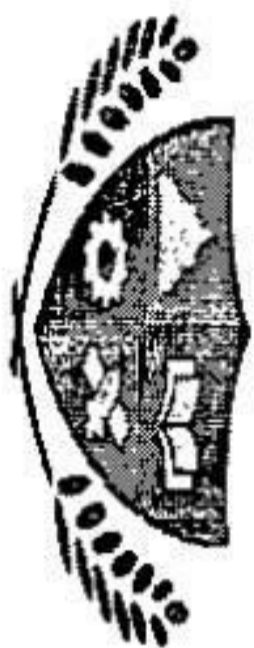

**PONNAIYAH RAMAJAYAM INSTITUTE OF
SCIENCE & TECHNOLOGY (PRIST)**
Declared as DEEMED-TO-BE UNIVERSITY
U/s 3 of UGC Act, 1956

**SCHOOL OF COMMERCE AND MANAGEMENT
VALUE ADDED COURSE
DEPARTMENT OF COMMERCE
CERTIFICATE OF APPRECIATION**

This is to certify that Ms/Mr Anandhi S Reg.No 2201CN220108 has

Completed the value added course on Certificate Course in GST
from 17/07/23 to 18/09/23 during the academic year of 2023 to 2024.

COURSE COORDINATOR

HOD

DEAN

Department of Commerce
Ponnaiyah Ramajayam Institute of
Science & Technology (PRIST),
Declared as DEEMED TO BE UNIVERSITY

School of Commerce and Management
Ponnaiyah Ramajayam Institute of
Science & Technology (PRIST),
THANJAVUR - 613 403.



**PONNAIYAH RAMAJAYAM INSTITUTE OF
SCIENCE & TECHNOLOGY (PRIST)**
Declared as DEEMED TO BE UNIVERSITY
U/S 3 of UGC Act, 1956

**SCHOOL OF COMMERCE AND MANAGEMENT
VALUE ADDED COURSE
DEPARTMENT OF COMMERCE
CERTIFICATE OF APPRECIATION**

This is to certify that Ms/Mr Buwana D Reg.No 2201CN120102 has

Completed the value added course on Anti-Financial Fraud in GST
from 17/07/23 to 13/09/23 during the academic year of 2023 to 2024.

[Signature]
COURSE COORDINATOR

[Signature]
HOD

[Signature]
DEAN

Department of Commerce
Ponnaiyah Ramajayam Institute of
Science & Technology (PRIST),
Declared as DEEMED TO BE UNIVERSITY

School of Commerce and Management
Ponnaiyah Ramajayam Institute of
Science & Technology (PRIST)
THANJAVUR - 613 403.



**PONNAIYAH RAMAJAYAM INSTITUTE OF
SCIENCE & TECHNOLOGY (PRIST)**
Declared as DEEMED-TO-BE UNIVERSITY
U/s 3 of UGC Act, 1956

**SCHOOL OF COMMERCE AND MANAGEMENT
VALUE ADDED COURSE
DEPARTMENT OF COMMERCE
CERTIFICATE OF APPRECIATION**

This is to certify that Ms/Mr Ezhilarasi, N Reg.No 2201C1920110 has
Completed the value added course on Certificate Course in BSI
from 17/07/23 to 13/09/23 during the academic year of 2023 to 2024.

[Signature]
COURSE COORDINATOR

HOD

[Signature]
DEAN

HOD

DEAN

Department of Commerce
Ponnaiyah Ramajayam Institute of
Science & Technology (PRIST),
Declared as DEEMED TO BE UNIVERSITY

School of Commerce and Management
Ponnaiyah Ramajayam Institute of
Science & Technology (PRIST)
THANJAVUR - 613 403.



**PONNAIYAH RAMAJAYAM INSTITUTE OF
SCIENCE & TECHNOLOGY (PRIST)**
Declared as DEEMED-TO-BE-UNIVERSITY
U/s 3 of UGC Act, 1956

**SCHOOL OF COMMERCE AND MANAGEMENT
VALUE ADDED COURSE
DEPARTMENT OF COMMERCE
CERTIFICATE OF APPRECIATION**

This is to certify that Ms/Mr C. Pavanya Reg.No 22D1CN220111 has
Completed the value added course on Certificate Course in GST
from 17/07/23 to 13/09/23 during the academic year of 2023 to 2024.

COURSE COORDINATOR

HOD

DEAN

Department of Commerce
Ponnaiyah Ramajayam Institute of
Science & Technology (PRIST),
Declared as DEEMED TO BE UNIVERSITY

School of Commerce and Management
Ponnaiyah Ramajayam Institute of
Science & Technology (PRIST)
THANJAVUR - 613 403.



**PONNAIYAH RAMAJAYAM INSTITUTE OF
SCIENCE & TECHNOLOGY (PRIST)**
Declared as DEEMED-TO-BE-UNIVERSITY
U/s 3 of UGC Act, 1956

**SCHOOL OF COMMERCE AND MANAGEMENT
VALUE ADDED COURSE
DEPARTMENT OF COMMERCE
CERTIFICATE OF APPRECIATION**

This is to certify that Ms/Mr S. Vidhyasree Reg.No 22D1CM20112 has

Completed the value added course on Certificate Course in GST
from 17/07/23 to 13/09/23 during the academic year of 2023 to 2024.

COURSE COORDINATOR

HOD

DEAN

Department of Commerce
Ponnaiyah Ramajayam Institute of
Science & Technology (PRIST),
Declared as DEEMED TO BE UNIVERSITY

School of Commerce and Management
Ponnaiyah Ramajayam Institute of
Science & Technology (PRIST)
THANJAVUR - 613 403.



**PONNAIYAH RAMAJAYAM INSTITUTE OF
SCIENCE & TECHNOLOGY (PRIST)**
Declared as DEEMED TO BE UNIVERSITY
U/s 3 of UGC Act, 1956

**SCHOOL OF COMMERCE AND MANAGEMENT
VALUE ADDED COURSE
DEPARTMENT OF COMMERCE
CERTIFICATE OF APPRECIATION**

This is to certify that Ms/Mr Geetha J Reg.No 2201CN920113 has

Completed the value added course on Certificate Course in GST
from 17/07/23 to 13/09/23 during the academic year of 2023 to 2024.

COURSE COORDINATOR

HOD

DEAN

Department of Commerce
Ponnaiyah Ramajayam Institute of
Science & Technology (PRIST),
Declared as DEEMED TO BE UNIVERSITY

School of Commerce and Management
Ponnaiyah Ramajayam Institute of
Science & Technology (PRIST)
THANJAVUR - 613 403.



**PONNAIYAH RAMAJAYAM INSTITUTE OF
SCIENCE & TECHNOLOGY (PRIST)**
Declared as DEEMED-TO-BE UNIVERSITY
U/s 3 of UGC Act, 1956

**SCHOOL OF COMMERCE AND MANAGEMENT
VALUE ADDED COURSE
DEPARTMENT OF COMMERCE
CERTIFICATE OF APPRECIATION**

This is to certify that Ms/Mr J. Karthikeyan Reg.No 2201C1920114 has
Completed the value added course on Certificate Course in GST
from 11/07/23 to 13/09/23 during the academic year of 2023 to 2024.

COURSE COORDINATOR

HOD

DEAN

Department of Commerce
Ponnaiyah Ramajayam Institute of
Science & Technology (PRIST),
Declared as DEEMED TO BE UNIVERSITY

School of Commerce and Management
Ponnaiyah Ramajayam Institute of
Science & Technology (PRIST)
THANJAVUR - 613 403.



**PONNAIYAH RAMAJAYAM INSTITUTE OF
SCIENCE & TECHNOLOGY (PRIST)**
Declared as DEEMED TO BE UNIVERSITY
U/s 3 of UGC Act, 1956

**SCHOOL OF COMMERCE AND MANAGEMENT
VALUE ADDED COURSE
DEPARTMENT OF COMMERCE
CERTIFICATE OF APPRECIATION**

This is to certify that Ms/Mr Ranjani N Reg.No 2201CN220115 has

Completed the value added course on Certificate Course in GST
from 17/07/23 to 13/09/23 during the academic year of 2023 to 2024.

COURSE COORDINATOR

HOD

DEAN

Department of Commerce
Ponnaiyah Ramajayam Institute of
Science & Technology (PRIST),
Declared as DEEMED TO BE UNIVERSITY

School of Commerce and Management
Ponnaiyah Ramajayam Institute of
Science & Technology (PRIST)
THANJAVUR - 613 403.



**PONNAIYAH RAMAJAYAM INSTITUTE OF
SCIENCE & TECHNOLOGY (PRIST)**
Declared as DEEMED-TO-BE-UNIVERSITY
U/s 3 of UGC Act, 1956

**SCHOOL OF COMMERCE AND MANAGEMENT
VALUE ADDED COURSE
DEPARTMENT OF COMMERCE
CERTIFICATE OF APPRECIATION**

This is to certify that Ms/Mr M. Senthil Reg.No 2201CM190116 has

Completed the value added course on Certificate Course in GST
from 17/07/23 to 13/09/23 during the academic year of 2023 to 2024.

K. Senthil
COURSE COORDINATOR
K. Senthil
HOD
DEAN

Department of Commerce
Ponnaiyah Ramajayam Institute of
Science & Technology (PRIST),
Declared as DEEMED TO BE UNIVERSITY

School of Commerce and Management
Ponnaiyah Ramajayam Institute of
Science & Technology (PRIST)
THANJAVUR - 613 403.



**PONNAIYAH RAMAJAYAM INSTITUTE OF
SCIENCE & TECHNOLOGY (PRIST)**
Declared as DEEMED TO BE UNIVERSITY
U/s 3 of UGC Act, 1956

**SCHOOL OF COMMERCE AND MANAGEMENT
VALUE ADDED COURSE
DEPARTMENT OF COMMERCE
CERTIFICATE OF APPRECIATION**

This is to certify that Ms/Mr Ms Meega Reg.No 22 DICM9 D201 has

Completed the value added course on Certificate Course in GST
from 17/07/23 to 13/09/23 during the academic year of 2023 to 2024.

COURSE COORDINATOR

HOD

[Signature]

[Signature]

DEAN

Department of Commerce
Ponnaiyah Ramajayam Institute of
Science & Technology (PRIST),
Declared as DEEMED TO BE UNIVERSITY

School of Commerce and Management
Ponnaiyah Ramajayam Institute of
Science & Technology (PRIST),
THANJAVUR - 613 403.



**PONNAIYAH RAMAJAYAM INSTITUTE OF
SCIENCE & TECHNOLOGY (PRIST)**
Declared as DEEMED-TO-BE-UNIVERSITY
U/s 3 of UGC Act, 1956

**SCHOOL OF COMMERCE AND MANAGEMENT
VALUE ADDED COURSE
DEPARTMENT OF COMMERCE
CERTIFICATE OF APPRECIATION**

This is to certify that Ms/Mr J. Vijaya dhanashini Reg.No 2201C1920202 has

Completed the value added course on Certificate Course in GST
from 17/07/23 to 13/09/23 during the academic year of 2023 to 2024.

[Signature]
COURSE COORDINATOR

[Signature]
HOD

[Signature]
DEAN

Department of Commerce
Ponnaiyah Ramajayam Institute of
Science & Technology (PRIST),
Declared as DEEMED TO BE UNIVERSITY

School of Commerce and Management
Ponnaiyah Ramajayam Institute of
Science & Technology (PRIST)
THANJAVUR - 613 403.



**PONNAIYAH RAMAJAYAM INSTITUTE OF
SCIENCE & TECHNOLOGY (PRIST)**
Declared as DEEMED-TO-BE UNIVERSITY
U/s 3 of UGC Act, 1956

**SCHOOL OF COMMERCE AND MANAGEMENT
VALUE ADDED COURSE
DEPARTMENT OF COMMERCE
CERTIFICATE OF APPRECIATION**

This is to certify that Ms/Mr A. N. Duwetha Reg.No 2201C1920023 has
Completed the value added course on Certificate Course in GST
from 17/07/23 to 13/09/23 during the academic year of 2023 to 2024.

[Signature]
COURSE COORDINATOR

[Signature]
HOD

[Signature]
DEAN

Department of Commerce
Ponnaiyah Ramajayam Institute of
Science & Technology (PRIST),
Declared as DEEMED TO BE UNIVERSITY

School of Commerce and Management
Ponnaiyah Ramajayam Institute of
Science & Technology (PRIST)
THANJAVUR - 613 403.



**PONNAIYAH RAMAJAYAM INSTITUTE OF
SCIENCE & TECHNOLOGY (PRIST)**
Declared as DEEMED TO BE UNIVERSITY
U/s 3 of UGC Act, 1956

**SCHOOL OF COMMERCE AND MANAGEMENT
VALUE ADDED COURSE
DEPARTMENT OF COMMERCE
CERTIFICATE OF APPRECIATION**

This is to certify that Ms/Mr R. Pavithra Reg.No 2201C1920204 has

Completed the value added course on Certificate Course in GST
from 17/07/23 to 13/09/23 during the academic year of 2023 to 2024.

COURSE COORDINATOR

HOD

DEAN

Department of Commerce
Ponnaiyah Ramajayam Institute of
Science & Technology (PRIST),
Declared as DEEMED TO BE UNIVERSITY

School of Commerce and Management
Ponnaiyah Ramajayam Institute of
Science & Technology (PRIST)
THANJAVUR - 613 403.



**PONNAIYAH RAMAJAYAM INSTITUTE OF
SCIENCE & TECHNOLOGY (PRIST)**

Declared as DEEMED-TO-BE-UNIVERSITY
U/s 3 of UGC Act, 1956

**SCHOOL OF COMMERCE AND MANAGEMENT
VALUE ADDED COURSE
DEPARTMENT OF COMMERCE
CERTIFICATE OF APPRECIATION**

This is to certify that Ms/Mr Mathavan, V Reg.No 2801CNG 20191 has

Completed the value added course on Certificate Course in O&ST
from 17/07/23 to 13/09/23 during the academic year of 2023 to 2024.

COURSE COORDINATOR

HOD

HOD

DEAN

DEAN

Department of Commerce
Ponnaiyah Ramajayam Institute of
Science & Technology (PRIST),
Declared as DEEMED TO BE UNIVERSITY

School of Commerce and Management
Ponnaiyah Ramajayam Institute of
Science & Technology (PRIST)
THANJAVUR - 613 403.



**PONNAIYAH RAMAJAYAM INSTITUTE OF
SCIENCE & TECHNOLOGY (PRIST)**
Declared as DEEMED-TO-BE UNIVERSITY
U/s 3 of UGC Act, 1956

**SCHOOL OF COMMERCE AND MANAGEMENT
VALUE ADDED COURSE
DEPARTMENT OF COMMERCE
CERTIFICATE OF APPRECIATION**

This is to certify that Ms/Mr Bharathiraj. K Reg.No 2301CMT20102 has

Completed the value added course on Certificate Course in GST
from 17/07/23 to 13/09/23 during the academic year of 2023 to 2024.

COURSE COORDINATOR

HOD

DEAN

Department of Commerce
Ponnaiyah Ramajayam Institute of
Science & Technology (PRIST),
Declared as DEEMED TO BE UNIVERSITY

School of Commerce and Management
Ponnaiyah Ramajayam Institute of
Science & Technology (PRIST)
THANJAVUR - 613 403.



**PONNAIYAH RAMAJAYAM INSTITUTE OF
SCIENCE & TECHNOLOGY (PRIST)**

Declared as DEEMED TO BE UNIVERSITY
U/s 3 of UGC Act, 1956

**SCHOOL OF COMMERCE AND MANAGEMENT
VALUE ADDED COURSE
DEPARTMENT OF COMMERCE
CERTIFICATE OF APPRECIATION**

This is to certify that Ms/Mr S. Vijay Reg.No 2801C1920103 has

Completed the value added course on Certificate Course in GST
from 17/07/23 to 13/09/23 during the academic year of 2023 to 2024.

COURSE COORDINATOR

HOD

HOD

DEAN

DEAN

Department of Commerce
Ponnaiyah Ramajayam Institute of
Science & Technology (PRIST),
Declared as DEEMED TO BE UNIVERSITY

School of Commerce and Management
Ponnaiyah Ramajayam Institute of
Science & Technology (PRIST)
THANJAVUR - 613 403.



**PONNAIYAH RAMAJAYAM INSTITUTE OF
SCIENCE & TECHNOLOGY (PRIST)**
Declared as DEEMED TO BE UNIVERSITY
U/s 3 of UGC Act, 1956

**SCHOOL OF COMMERCE AND MANAGEMENT
VALUE ADDED COURSE
DEPARTMENT OF COMMERCE
CERTIFICATE OF APPRECIATION**

This is to certify that Ms/Mr R. Aritha Kumar Reg.No 2301CM20104 has

Completed the value added course on Certificate Course in GST
from 17/07/23 to 13/09/23 during the academic year of 2023 to 2024.

COURSE COORDINATOR

HOD

HOD

DEAN

[Handwritten Signature]

[Handwritten Signature]

[Handwritten Signature]

Department of Commerce
Ponnaiyah Ramajayam Institute of
Science & Technology (PRIST),
Declared as DEEMED TO BE UNIVERSITY

School of Commerce and Management
Ponnaiyah Ramajayam Institute of
Science & Technology (PRIST)
THANJAVUR - 613 403.



**PONNAIYAH RAMAJAYAM INSTITUTE OF
SCIENCE & TECHNOLOGY (PRIST)**

Declared as DEEMED-TO-BE-UNIVERSITY
U/s 3 of UGC Act, 1956

**SCHOOL OF COMMERCE AND MANAGEMENT
VALUE ADDED COURSE
DEPARTMENT OF COMMERCE
CERTIFICATE OF APPRECIATION**

This is to certify that Ms/Mr Ragul A Reg.No 2201BP10105 has

Completed the value added course on E-Filing of Income Tax (ET&TDS)
from 17/07/23 to 13/09/23 during the academic year of 2023 to 2024.

[Signature]
COURSE COORDINATOR

[Signature]
HOD

[Signature]
DEAN

Department of Commerce
Ponnaiyah Ramajayam Institute of
Science & Technology (PRIST),
Declared as DEEMED TO BE UNIVERSITY

School of Commerce and Management
Ponnaiyah Ramajayam Institute of
Science & Technology (PRIST)
THANJAVUR - 613 403.



**PONNAIYAH RAMAJAYAM INSTITUTE OF
SCIENCE & TECHNOLOGY (PRIST)**

Declared as DEEMED-TO-BE-UNIVERSITY
U/s 3 of UGC Act, 1956

**SCHOOL OF COMMERCE AND MANAGEMENT
VALUE ADDED COURSE
DEPARTMENT OF COMMERCE
CERTIFICATE OF APPRECIATION**

This is to certify that Ms/Mr Dhanush. G Reg.No 2201BPI10104 has

Completed the value added course on E-filing of Income Tax (TDS)
from 17/07/23 to 13/09/23 during the academic year of 2023 to 2024.

COURSE COORDINATOR

HOD

DEAN

Department of Commerce
Ponnaiyah Ramajayam Institute of
Science & Technology (PRIST),
Declared as DEEMED TO BE UNIVERSITY

School of Commerce and Management
Ponnaiyah Ramajayam Institute of
Science & Technology (PRIST)
THANJAVUR. 613 403.



**PONNAIYAH RAMAJAYAM INSTITUTE OF
SCIENCE & TECHNOLOGY (PRIST)**
Declared as DEEMED-TO-BE UNIVERSITY
U/s 3 of UGC Act, 1956

**SCHOOL OF COMMERCE AND MANAGEMENT
VALUE ADDED COURSE
DEPARTMENT OF COMMERCE
CERTIFICATE OF APPRECIATION**

This is to certify that Ms/Mr Arun. A Reg.No 222019P10103 has
Completed the value added course on F-Filing of Income Tax (TDS)
from 17/07/23 to 13/09/23 during the academic year of 2023 to 2024.

COURSE COORDINATOR

HOD

DEAN

Department of Commerce
Ponnaiyah Ramajayam Institute of
Science & Technology (PRIST),
Declared as DEEMED TO BE UNIVERSITY

School of Commerce and Management
Ponnaiyah Ramajayam Institute of
Science & Technology (PRIST)
THANJAVUR - 613 403.



**PONNAIYAH RAMAJAYAM INSTITUTE OF
SCIENCE & TECHNOLOGY (PRIST)**
Declared as DEEMED-TO-BE-UNIVERSITY
U/s 3 of UGC Act, 1956

**SCHOOL OF COMMERCE AND MANAGEMENT
VALUE ADDED COURSE
DEPARTMENT OF COMMERCE
CERTIFICATE OF APPRECIATION**

This is to certify that Ms/Mr Deepale. A Reg.No 2201AP10102 has

Completed the value added course on F-Filling of Income Tax (TPT & TDS)
from 17/07/23 to 13/09/23 during the academic year of 2023 to 2024.

COURSE COORDINATOR

HOD

DEAN

DEAN

Department of Commerce
Ponnaiyah Ramajayam Institute of
Science & Technology (PRIST),
Declared as DEEMED TO BE UNIVERSITY

School of Commerce and Management
Ponnaiyah Ramajayam Institute of
Science & Technology (PRIST)
THANJAVUR - 613 403.



**PONNAIYAH RAMAJAYAM INSTITUTE OF
SCIENCE & TECHNOLOGY (PRIST)**

Declared as DEEMED-TO-BE-UNIVERSITY
U/s 3 of UGC Act, 1956

**SCHOOL OF COMMERCE AND MANAGEMENT
VALUE ADDED COURSE
DEPARTMENT OF COMMERCE
CERTIFICATE OF APPRECIATION**

This is to certify that Ms/Mr Shamshara J Reg.No 2201AP10101 has

Completed the value added course on E-Filing of Income Tax (PRT & TDS)
from 17/07/23 to 13/09/23 during the academic year of 2023 to 2024.

COURSE COORDINATOR

HOD

DEAN

Department of Commerce
Ponnaiyah Ramajayam Institute of
Science & Technology (PRIST),
Declared as DEEMED TO BE UNIVERSITY

School of Commerce and Management
Ponnaiyah Ramajayam Institute of
Science & Technology (PRIST)
THANJAVUR - 613 403.



**PONNAIYAH RAMAJAYAM INSTITUTE OF
SCIENCE & TECHNOLOGY (PRIST)**
Declared as DEEMED-TO-BE-UNIVERSITY
U/s 3 of UGC Act, 1956

**SCHOOL OF COMMERCE AND MANAGEMENT
VALUE ADDED COURSE
DEPARTMENT OF COMMERCE
CERTIFICATE OF APPRECIATION**

This is to certify that Ms/Mr Hadan Ali. H Reg.No 2201AP10106 has

Completed the value added course on E - Filling of Income Tax (TITATS)
from 17/07/23 to 13/09/23 during the academic year of 2023 to 2024.

COURSE COORDINATOR

HOD

HOD

DEAN

DEAN

Department of Commerce
Ponnaiyah Ramajayam Institute of
Science & Technology (PRIST),
Declared as DEEMED TO BE UNIVERSITY

School of Commerce and Management
Ponnaiyah Ramajayam Institute of
Science & Technology (PRIST)
THANJAVUR - 613 403.



**PONNAIYAH RAMAJAYAM INSTITUTE OF
SCIENCE & TECHNOLOGY (PRIST)**
Declared as DEEMED-TO-BE-UNIVERSITY
U/s 3 of UGC Act, 1956

**SCHOOL OF COMMERCE AND MANAGEMENT
VALUE ADDED COURSE
DEPARTMENT OF COMMERCE
CERTIFICATE OF APPRECIATION**

This is to certify that Ms/Mr GOKUL.S.P Reg.No 2201AP10108 has

Completed the value added course on E-Filing of Income Tax [TPT & TDS]
from 17/07/2023 to 13/09/2023 during the academic year of 2023 to 2024.

COURSE COORDINATOR

HOD

DEAN

DEAN

Department of Commerce
Ponnaiyah Ramajayam Institute of
Science & Technology (PRIST),
Declared as DEEMED TO BE UNIVERSITY

School of Commerce and Management
Ponnaiyah Ramajayam Institute of
Science & Technology (PRIST)
THANJAVUR-613 403.

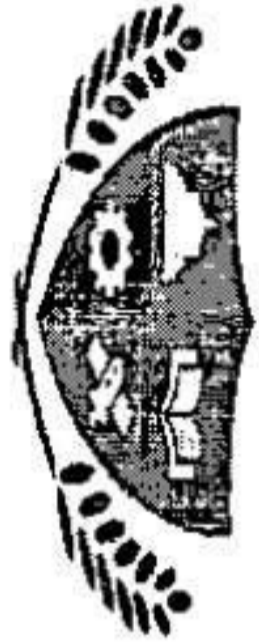

**PONNAIYAH RAMAJAYAM INSTITUTE OF
SCIENCE & TECHNOLOGY (PRIST)**

Declared as DEEMED-TO-BE-UNIVERSITY
U/s 3 of UGC Act, 1956

**SCHOOL OF COMMERCE AND MANAGEMENT
VALUE ADDED COURSE
DEPARTMENT OF COMMERCE
CERTIFICATE OF APPRECIATION**

This is to certify that Ms/Mr LYAPPAN.A Reg.No 221AP10107 has

Completed the value added course on E-filing of Income Tax [IT&TPT]
from 17/07/23 to 13/09/23 during the academic year of 2023 to 2024.

COURSE COORDINATOR

HOD

HOD

DEAN

DEAN

Department of Commerce
Ponnaiyah Ramajayam Institute of
Science & Technology (PRIST),
Declared as DEEMED TO BE UNIVERSITY

School of Commerce and Management
Ponnaiyah Ramajayam Institute of
Science & Technology (PRIST)
THANJAVUR - 613 403.



**PONNAIYAH RAMAJAYAM INSTITUTE OF
SCIENCE & TECHNOLOGY (PRIST)**
Declared as DEEMED-TO-BE UNIVERSITY
U/s 3 of UGC Act, 1956

**SCHOOL OF COMMERCE AND MANAGEMENT
VALUE ADDED COURSE
DEPARTMENT OF COMMERCE
CERTIFICATE OF APPRECIATION**

This is to certify that Ms/Mr NARESH.V Reg.No 2001AP101009 has
Completed the value added course on E Filing of Income Tax Returns
from 17/07/23 to 13/09/23 during the academic year of 2023 to 2024.

COURSE COORDINATOR

HOD

DEAN

Department of Commerce
Ponnaiyah Ramajayam Institute of
Science & Technology (PRIST),
Declared as DEEMED TO BE UNIVERSITY

School of Commerce and Management
Ponnaiyah Ramajayam Institute of
Science & Technology (PRIST)
THANJAVUR - 613 403.



**PONNAIYAH RAMAJAYAM INSTITUTE OF
SCIENCE & TECHNOLOGY (PRIST)**
Declared as DEEMED-TO-BE-UNIVERSITY
U/s 3 of UGC Act, 1956

**SCHOOL OF COMMERCE AND MANAGEMENT
VALUE ADDED COURSE
DEPARTMENT OF COMMERCE
CERTIFICATE OF APPRECIATION**

This is to certify that Ms/Mr NOTHAMED ARSHITH AJM Reg.No 2201PAP10110 has
Completed the value added course on E-Filing of Income Tax [ITR 1/2]
from 17/07/23 to 13/09/23 during the academic year of 2023 to 2024.

COURSE COORDINATOR

HOD

DEAN

Department of Commerce
Ponnaiyah Ramajayam Institute of
Science & Technology (PRIST),
Declared as DEEMED TO BE UNIVERSITY

School of Commerce and Management
Ponnaiyah Ramajayam Institute of
Science & Technology (PRIST)
THANJAVUR - 613 403.



**PONNAIYAH RAMAJAYAM INSTITUTE OF
SCIENCE & TECHNOLOGY (PRIST)**
Declared as DEEMED-TO-BE-UNIVERSITY
U/s 3 of UGC Act, 1956

**SCHOOL OF COMMERCE AND MANAGEMENT
VALUE ADDED COURSE
DEPARTMENT OF COMMERCE
CERTIFICATE OF APPRECIATION**

This is to certify that Ms/Mr PRAGADEESH H. R Reg.No 2201MP10111 has
Completed the value added course on E-Filling of Invoice for IRT & TRST
from 17/07/23 to 13/09/23 during the academic year of 2023 to 2024.

COURSE COORDINATOR

HOD

DEAN

Department of Commerce
Ponnaiyah Ramajayam Institute of
Science & Technology (PRIST),
Declared as DEEMED TO BE UNIVERSITY

School of Commerce and Management
Ponnaiyah Ramajayam Institute of
Science & Technology (PRIST)
THANJAVUR - 613 403.

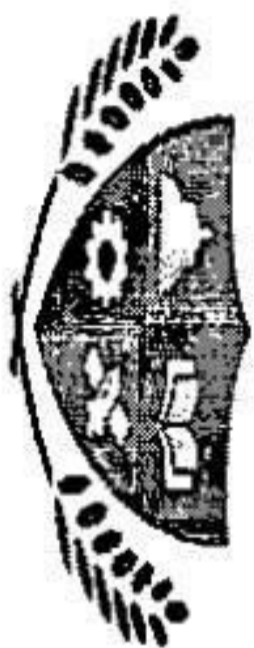

**PONNAIYAH RAMAJAYAM INSTITUTE OF
SCIENCE & TECHNOLOGY (PRIST)**
Declared as DEEMED-TO-BE-UNIVERSITY
U/s 3 of UGC Act, 1956

**SCHOOL OF COMMERCE AND MANAGEMENT
VALUE ADDED COURSE
DEPARTMENT OF COMMERCE
CERTIFICATE OF APPRECIATION**

This is to certify that Ms/Mr HARI GRANESH R Reg.No 22JA110112 has
Completed the value added course on E-Following of Muma for IRT&TPS
from 11/07/23 to 13/09/23 during the academic year of 2023 to 2024.

COURSE COORDINATOR

HOD

DEAN

DEAN

Department of Commerce
Ponnaiyah Ramajayam Institute of
Science & Technology (PRIST),
Declared as DEEMED TO BE UNIVERSITY

School of Commerce and Management
Ponnaiyah Ramajayam Institute of
Science & Technology (PRIST)
THANJAVUR - 613 403.



**PONNAIYAH RAMAJAYAM INSTITUTE OF
SCIENCE & TECHNOLOGY (PRIST)**
Declared as DEEMED-TO-BE UNIVERSITY
U/s 3 of UGC Act, 1956

**SCHOOL OF COMMERCE AND MANAGEMENT
VALUE ADDED COURSE
DEPARTMENT OF COMMERCE
CERTIFICATE OF APPRECIATION**

This is to certify that Ms/Mr KARTHIKEYAN, M Reg.No 2201AP10113 has
Completed the value added course on E-filing of Income Tax [ITR&TDS]
from 17/07/23 to 13/09/23 during the academic year of 2023 to 2024.

COURSE COORDINATOR

HOD

DEAN

Department of Commerce
Ponnaiyah Ramajayam Institute of
Science & Technology (PRIST),
Declared as DEEMED TO BE UNIVERSITY

School of Commerce and Management
Ponnaiyah Ramajayam Institute of
Science & Technology (PRIST)
THANJAVUR - 613 403.



**PONNAIYAH RAMAJAYAM INSTITUTE OF
SCIENCE & TECHNOLOGY (PRIST)**
Declared as DEEMED-TO-BE-UNIVERSITY
U/s 3 of UGC Act, 1956

**SCHOOL OF COMMERCE AND MANAGEMENT
VALUE ADDED COURSE
DEPARTMENT OF COMMERCE
CERTIFICATE OF APPRECIATION**

This is to certify that Ms/Mr RAJESH .R Reg.No 2201AP10114 has
Completed the value added course on E-Filing of Income Tax [Practicals]
from 17/07/23 to 13/09/23 during the academic year of 2023 to 2024.

[Signature]
COURSE COORDINATOR

[Signature]
HOD

[Signature]
DEAN

Department of Commerce
Ponnaiyah Ramajayam Institute of
Science & Technology (PRIST),
Declared as DEEMED TO BE UNIVERSITY

School of Commerce and Management
Ponnaiyah Ramajayam Institute of
Science & Technology (PRIST),
THANJAVUR - 613 403.



**PONNAIYAH RAMAJAYAM INSTITUTE OF
SCIENCE & TECHNOLOGY (PRIST)**
Declared as DEEMED-TO-BE-UNIVERSITY
U/s 3 of UGC Act, 1956

**SCHOOL OF COMMERCE AND MANAGEMENT
VALUE ADDED COURSE
DEPARTMENT OF COMMERCE
CERTIFICATE OF APPRECIATION**

This is to certify that Ms/Mr ATHY. R Reg.No 2201AP0115 has

Completed the value added course on E-Filing of Income Tax [ET & TDS]
from 17/07/23 to 13/09/23 during the academic year of 2023 to 2024.

COURSE COORDINATOR

HOD

DEAN

DEAN

Department of Commerce
Ponnaiyah Ramajayam Institute of
Science & Technology (PRIST),
Declared as DEEMED TO BE UNIVERSITY

School of Commerce and Management
Ponnaiyah Ramajayam Institute of
Science & Technology (PRIST)
THANJAVUR - 613 403.



**PONNAIYAH RAMAJAYAM INSTITUTE OF
SCIENCE & TECHNOLOGY (PRIST)**
Declared as DEEMED TO BE UNIVERSITY
U/S 3 of UGC Act, 1956

**SCHOOL OF COMMERCE AND MANAGEMENT
VALUE ADDED COURSE
DEPARTMENT OF COMMERCE
CERTIFICATE OF APPRECIATION**

This is to certify that Ms/Mr RAMESH.P Reg.No 2201AP10116 has

Completed the value added course on E-Filing of Income Tax PRIST
from 17/07/23 to 15/09/23 during the academic year of 2023 to 2024.

COURSE COORDINATOR

HOD

DEAN

Department of Commerce
Ponnaiyah Ramajayam Institute of
Science & Technology (PRIST),
Declared as DEEMED TO BE UNIVERSITY

School of Commerce and Management
Ponnaiyah Ramajayam Institute of
Science & Technology (PRIST)
THANJAVUR - 613 403.



**PONNAIYAH RAMAJAYAM INSTITUTE OF
SCIENCE & TECHNOLOGY (PRIST)**
Declared as DEEMED-TO-BE UNIVERSITY
U/s 3 of UGC Act, 1956

**SCHOOL OF COMMERCE AND MANAGEMENT
VALUE ADDED COURSE
DEPARTMENT OF COMMERCE
CERTIFICATE OF APPRECIATION**

This is to certify that Ms/Mr NAGENDRA KUMAR.P Reg.No 2201A110117 has
Completed the value added course on E-Filing of Income Tax [107 & 103]
from _____ to _____ during the academic year of 2023 to 2024.

COURSE COORDINATOR

HOD

DEAN

Department of Commerce
Ponnaiyah Ramajayam Institute of
Science & Technology (PRIST),
Declared as DEEMED TO BE UNIVERSITY

School of Commerce and Management
Ponnaiyah Ramajayam Institute of
Science & Technology (PRIST)
THANJAVUR - 613 403.



**PONNAIYAH RAMAJAYAM INSTITUTE OF
SCIENCE & TECHNOLOGY (PRIST)**

Declared as DEEMED-TO-BE-UNIVERSITY
U/s 3 of UGC Act, 1956

**SCHOOL OF COMMERCE AND MANAGEMENT
VALUE ADDED COURSE
DEPARTMENT OF COMMERCE
CERTIFICATE OF APPRECIATION**

This is to certify that Ms/Mr APARISH KARKK Reg.No 2201MPL0118 has
Completed the value added course on E-filing of Income Tax [RT & TDS]
from 17/07/23 to 13/09/23 during the academic year of 2023 to 2024.

[Signature]
COURSE COORDINATOR

[Signature]
HOD

[Signature]
DEAN

Department of Commerce
Ponnaiyah Ramajayam Institute of
Science & Technology (PRIST),
Declared as DEEMED TO BE UNIVERSITY

School of Commerce and Management
Ponnaiyah Ramajayam Institute of
Science & Technology (PRIST)
THANJAVUR - 613 403.



**PONNAIYAH RAMAJAYAM INSTITUTE OF
SCIENCE & TECHNOLOGY (PRIST)**

Declared as DEEMED-TO-BE-UNIVERSITY
U/s 3 of UGC Act, 1956

**SCHOOL OF COMMERCE AND MANAGEMENT
VALUE ADDED COURSE
DEPARTMENT OF COMMERCE
CERTIFICATE OF APPRECIATION**

This is to certify that Ms/Mr MOHAMMED RYAZ Reg.No 2201AP10119 has

Completed the value added course on E-Filing of Income Tax [ITR&TDS]
from 11/10/23 to 13/03/24 during the academic year of 2023 to 2024.

COURSE COORDINATOR

HOD

DEAN

DEAN

Department of Commerce
Ponnaiyah Ramajayam Institute of
Science & Technology (PRIST),
Declared as DEEMED TO BE UNIVERSITY

School of Commerce and Management
Ponnaiyah Ramajayam Institute of
Science & Technology (PRIST)
THANJAVUR - 613 403.



**PONNAIYAH RAMAJAYAM INSTITUTE OF
SCIENCE & TECHNOLOGY (PRIST)**
Declared as DEEMED TO BE UNIVERSITY
U/s 3 of UGC Act, 1956

**SCHOOL OF COMMERCE AND MANAGEMENT
VALUE ADDED COURSE
DEPARTMENT OF COMMERCE
CERTIFICATE OF APPRECIATION**

This is to certify that Ms/Mr GIRIYON RAJ.R Reg.No 2201AP10201 has
Completed the value added course on E-Filing of Income Tax [STARTER]
from 17/07/23 to 13/09/23 during the academic year of 2023 to 2024.

COURSE COORDINATOR

HOD

DEAN

Department of Commerce
Ponnaiyah Ramajayam Institute of
Science & Technology (PRIST),
Declared as DEEMED TO BE UNIVERSITY

School of Commerce and Management
Ponnaiyah Ramajayam Institute of
Science & Technology (PRIST)
THANJAVUR - 613 403.



**PONNAIYAH RAMAJAYAM INSTITUTE OF
SCIENCE & TECHNOLOGY (PRIST)**
Declared as DEEMED-TO-BE UNIVERSITY
U/s 3 of UGC Act, 1956

**SCHOOL OF COMMERCE AND MANAGEMENT
VALUE ADDED COURSE
DEPARTMENT OF COMMERCE
CERTIFICATE OF APPRECIATION**

This is to certify that Ms/Mr GOKUL RAM.N Reg.No 2201AP10202 has
Completed the value added course on E-Filing of Income Tax [ITR:ITPS]
from 11/01/23 to 13/09/23 during the academic year of 2023 to 2024.

COURSE COORDINATOR

HOD

DEAN

DEAN

Department of Commerce
Ponnaiyah Ramajayam Institute of
Science & Technology (PRIST),
Declared as DEEMED TO BE UNIVERSITY

School of Commerce and Management
Ponnaiyah Ramajayam Institute of
Science & Technology (PRIST)
THANJAVUR - 513 403.



**PONNAIYAH RAMAJAYAM INSTITUTE OF
SCIENCE & TECHNOLOGY (PRIST)**
Declared as DEEMED TO BE UNIVERSITY
U/s 3 of UGC Act, 1956

**SCHOOL OF COMMERCE AND MANAGEMENT
VALUE ADDED COURSE
DEPARTMENT OF COMMERCE
CERTIFICATE OF APPRECIATION**

This is to certify that Ms/Mr MEENA. K Reg.No 2201AP10203 has
Completed the value added course on E-Filing of Income Tax [ITR2]
from 17/07/23 to 19/09/23 during the academic year of 2023 to 2024.

[Signature]
COURSE COORDINATOR

[Signature]
HOD

[Signature]
DEAN

Department of Commerce
Ponnaiyah Ramajayam Institute of
Science & Technology (PRIST),
Declared as DEEMED TO BE UNIVERSITY

School of Commerce and Management
Ponnaiyah Ramajayam Institute of
Science & Technology (PRIST)
THANJAVUR - 613 403.

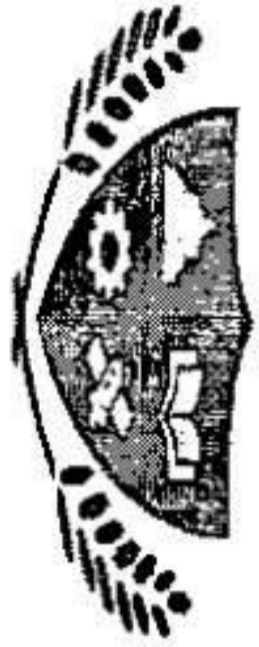

**PONNAIYAH RAMAJAYAM INSTITUTE OF
SCIENCE & TECHNOLOGY (PRIST)**

Declared as DEEMED-TO-BE-UNIVERSITY
U/s 3 of UGC Act, 1956

**SCHOOL OF COMMERCE AND MANAGEMENT
VALUE ADDED COURSE
DEPARTMENT OF COMMERCE
CERTIFICATE OF APPRECIATION**

This is to certify that Ms/Mr GRABHA PRIYA.D Reg.No 2201AP10204 has

Completed the value added course on E-Filling of Income tax returns
from 11/01/23 to 13/09/23 during the academic year of 2023 to 2024.

COURSE COORDINATOR

HOD

DEAN

DEAN

Department of Commerce
Ponnaiyah Ramajayam Institute of
Science & Technology (PRIST),
Declared as DEEMED TO BE UNIVERSITY

School of Commerce and Management
Ponnaiyah Ramajayam Institute of
Science & Technology (PRIST)
THANJAVUR - 613 403.



**PONNAIYAH RAMAJAYAM INSTITUTE OF
SCIENCE & TECHNOLOGY (PRIST)**

Declared as DEEMED-TO-BE-UNIVERSITY
U/s 3 of UGC Act, 1956

**SCHOOL OF COMMERCE AND MANAGEMENT
VALUE ADDED COURSE
DEPARTMENT OF COMMERCE
CERTIFICATE OF APPRECIATION**

This is to certify that Ms/Mr VIGNAYALAKSHMI.S Reg.No 2201AP10205 has
Completed the value added course on E-Filing of Income Tax Returns
from 17/07/23 to 13/09/23 during the academic year of 2023 to 2024.

COURSE COORDINATOR

HOD

DEAN

DEAN

Department of Commerce
Ponnaiyah Ramajayam Institute of
Science & Technology (PRIST),
Declared as DEEMED TO BE UNIVERSITY

School of Commerce and Management
Ponnaiyah Ramajayam Institute of
Science & Technology (PRIST)
THANJAVUR - 613 403.



**PONNAIYAH RAMAJAYAM INSTITUTE OF
SCIENCE & TECHNOLOGY (PRIST)**
Declared as DEEMED-TO-BE UNIVERSITY
U/s 3 of UGC Act, 1956

**SCHOOL OF COMMERCE AND MANAGEMENT
VALUE ADDED COURSE
DEPARTMENT OF COMMERCE
CERTIFICATE OF APPRECIATION**

This is to certify that Ms/Mr SRI SREVA'S Reg.No 2201AP10206 has
Completed the value added course on E-filing of Income Tax [TDS & TDS]
from 17/07/23 to 13/09/23 during the academic year of 2023 to 2024.

COURSE COORDINATOR

HOD

DEAN

DEAN

Department of Commerce
Ponnaiyah Ramajayam Institute of
Science & Technology (PRIST),
Declared as DEEMED TO BE UNIVERSITY

School of Commerce and Management
Ponnaiyah Ramajayam Institute of
Science & Technology (PRIST)
THANJAVUR - 613 403.



**PONNAIYAH RAMAJAYAM INSTITUTE OF
SCIENCE & TECHNOLOGY (PRIST)**

Declared as DEEMED-TO-BE-UNIVERSITY
U/s 3 of UGC Act, 1956

**SCHOOL OF COMMERCE AND MANAGEMENT
VALUE ADDED COURSE
DEPARTMENT OF COMMERCE
CERTIFICATE OF APPRECIATION**

This is to certify that Ms/Mr GWNA MARY-G Reg.No 2201AP10204 has

Completed the value added course on E-Filing of Income Tax Returns
from 17/07/23 to 13/09/23 during the academic year of 2023 to 2024.

COURSE COORDINATOR

HOD

DEAN

DEAN

Department of Commerce
Ponnaiyah Ramajayam Institute of
Science & Technology (PRIST),
Declared as DEEMED TO BE UNIVERSITY

School of Commerce and Management
Ponnaiyah Ramajayam Institute of
Science & Technology (PRIST)
THANJAVUR - 613 403.



**PONNAIYAH RAMAJAYAM INSTITUTE OF
SCIENCE & TECHNOLOGY (PRIST)**

Declared as DEEMED-TO-BE-UNIVERSITY
U/s 3 of UGC Act, 1956

**SCHOOL OF COMMERCE AND MANAGEMENT
VALUE ADDED COURSE
DEPARTMENT OF COMMERCE
CERTIFICATE OF APPRECIATION**

This is to certify that Ms/Mr K. Siva Reg.No 2101cmj10131 has

Completed the value added course on Diploma in Event Management
from 20/07/23 to 18/12/23 during the academic year of 2023 to 2024.

COURSE COORDINATOR

HOD

HOD

DEAN

Department of Commerce
Ponnaiyah Ramajayam Institute of
Science & Technology (PRIST)
Declared as DEEMED TO BE UNIVERSITY

School of Commerce and Management
Ponnaiyah Ramajayam Institute of
Science & Technology (PRIST)
THANJAVUR - 613 403.



PONNAIYAH RAMAJAYAM INSTITUTE OF
SCIENCE & TECHNOLOGY (PRIST)

Declared as DEEMED TO BE UNIVERSITY
By 3 of UGC Act, 1956

SCHOOL OF ARTS AND SCIENCE
DEPARTMENT OF MICROBIOLOGY

CIRCULAR

6.07.2023

This is to inform all Life science students that the value added courses classes for the academic year 2023-2024 odd semester will commence from 12.07.2023. Hence requesting all registered students to attend the classes without fail.

1. Certificate Course in Biofertilizer Production Technology- 21516BPT
2. Certificate Course On Food Processing- 22516FP
3. Certificate Course on Clinical Laboratory Technology - 22516CLT
4. Diploma in Seaweed Culture-23516SC

A. Xavier
HOD **A. XAVIER FERNANDES, M.Sc. M.Phil. Ph.D.,**
Assistant Professor,
Department of Microbiology
School of Arts & Science
Prist Deemed to be University, Thanjavur.
Copy to:

DEAN

DEAN
School of Arts & Science
Ponnaiyah Ramajayam Institute of
Science & Technology (PRIST)
Deemed to be University
Vallam, Thanjavur - 613 403.

- 1.Hon'ble Vice Chancellor (for your kind information)
- 2.Registrar
- 3.Registrar office
- 4.Dean
- 5.Department file



PONNAIYAH RAMAJAYAM INSTITUTE OF
SCIENCE & TECHNOLOGY (PRIST)

Declared as DEEMED TO BE UNIVERSITY
Uis 3 of UGC Act, 1956

**SCHOOL OF ARTS AND SCIENCE
DEPARTMENT OF MICROBIOLOGY**
Certificate Course in Biofertilizer Production Technology

ACADEMIC YEAR 2023-2024

Subject Code: 21516BPT

Value added course: 1

Total: 45 hours

Course objectives:

To demonstrate the low cost media preparation and impart training of eco friendly agricultural inputs in biofertilizer production.

Course Outcomes:

- ❖ Ability to distinguish the types of biofertilizers and methods of application in farmers field
- ❖ Development of integrated management for best results using nitrogenous and phosphate biofertilizers.

Syllabus:

Unit I:

Introduction, History and concept of Bio fertilizers ,status scope and importance of Bio fertilizers, Classification of Bio fertilizers. Nitrogen fixation.

Unit II:

Structure and characteristic features of bacterial Bio fertilizers- Azospirillum, Azotobacter, Bacillus, Pseudomonas, Rhizobium and Frankia; Cynobacterial biofertilizers- Anabaena, Nostoc, Hapalosiphon and fungal biofertilizers- AM mycorrhiza and ectomycorrhiza.

Unit III:

Production technology: Strain selection, sterilization, growth and fermentation, equipment, mass production of carrier based and liquid bio fertiizers. FCO specifications and quality control of bio fertilizers.

Unit IV:

Application technology for seeds, seedlings, tubers, sets etc. Biofertilizers -Storage, shelf life, quality control and marketing. Factors influencing the efficacy of bio fertilizers.

Dr. A. XAVIER FERNANDES, M.Sc., Ph.D., M.Phil., Ph.D.,

Assistant Professor

Department of Microbiology

School of Arts & Science

Prist Deemed to be University, Thanjavur.

DEAN

**School of Arts & Science
Ponnaiyah Ramajayam Institute of
Science & Technology (PRIST)
Deemed to be University
Vallam, Thanjavur - 613 403.**

APPLICATION FORM

1. Full Name
2. Programme
3. Discipline
4. Institution Name
5. Date of Birth
6. Sex (M/F)
7. E. mail
8. Mobile No.
9. Permanent Address

Signature of the Applicant

Submission of Application Form

Submit your Application form in person to the co-ordinator, School of Arts and Science, PRIST University, Thanjavur, Vallam, 613 403.

Application may be send to

Course Co-Ordinator
Department of Microbiology
PRIST Deemed To Be University 613 403.
E-mail: bio06@prist.ac.in

About the University

Ponnaiyah Ramajayam Institute of Science and Technology (PRIST) is a deemed university in Vallam, India. The Institute offers undergraduate and postgraduate courses in Engineering, Science, Education, Management, Arts, and Law, as well as research programmes.

Facilities Available

The University is housed in an independent, multi-story building with state-of-art equipment, excellent Laboratories and infrastructure to help complete this course. Majority of scientists have been acting in monitoring the research program. Computer Library with internet facilities for students, Hostel facilities, Health center, Sports complex, etc...

Department of Microbiology

Microbiology course is very broad where one gets to touch and know about all the major areas of life (biological) sciences.

The Microbiology is focusing on some major areas like genetics, biochemistry, cell biology, molecular biology. So this course can provide much finer hand on: Clinical Laboratory Technology.



PONNAIYAH RAMAJAYAM INSTITUTE OF SCIENCE & TECHNOLOGY (PRIST)
DEEMED TO BE UNIVERSITY
VALLAM, THANJAVUR - 613 403

School of Arts and Science Department of Microbiology

Certificate Course
on
Biofertilizer Production
Technology
For admission to the
Academic Year
2023-2024



PRIST Deemed to be University
Thanjavur, Vallam-613 403

INTRODUCTION

Our world is surrounded by several environmental challenges that are becoming troublesome by the day. Therefore, the online course in Biofertilizer Production Technology by PRIST aim to enhance soil productivity by fixing atmospheric nitrogen, solubilizing soil phosphorus, and stimulating plant growth. Biofertilizer technology has integrated plant nutrient management for sustainable agriculture through BNF.

Importance of Biofertilizer Production Technology

Application of biofertilizers increases the plant growth, symbiotic traits (nodule number, nodule weight) and grain yield over no inoculation in different pulse crops without producing any adverse effect on the environment. And also improving the soil quality, protecting the plants from pathogens, avoiding environmental pollution, destruction of harmful substances present in the soil.

Course Content

- ◆ History and concepts of Bio fertilizers
- ◆ Structure and characteristic features of bacterial Bio fertilizers
- ◆ Production technology:
- ◆ Application technology

Objective the Program

The main aim of the unit is to promote the use of Biofertilizer technology, i.e., the addition of nutrients through the natural process of nitrogen fixation, solubilizing phosphorus, as well as the stimulation of plant growth by synthesizing growth-promoting substances.

Level of Knowledge Expected

Students studying Biofertilizer technology course gain expertise in soil ecosystem as biofertilizers play an imperative role by regenerating the soil microbial biodiversity and maintenance of soil health by mobilizing the plant.

Duration of the program

45 hrs add on Certificate course

Course Outcome

Develop analysis and synthesis skills. Obtain information, design experiments and interpret results. Students will understand the general aspects of laboratory safety, different hematology methods, sample preparation, processing, biochemical test and different different branches of Pharmacology

Eligibility criteria & Fee Structure

Any graduate shall be eligible for the admission to the course

Certification

The candidates successfully qualifying the course the course shall be awarded a certificate to that effect in the appropriate form by School of Arts and Science, Department of Microbiology, PRIST Deemed To Be University, Thanjavur, Vallam.

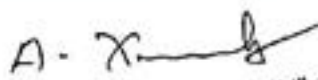
Dr. A. XAVIER FERNANDES, M.Sc. in Microbiology, Ph.D.,
Assistant Professor,
Department of Microbiology
School of Arts & Science
Prist Deemed to be University, Thanjavur.

DEAN
School of Arts & Science
Ponnaiyah Ramajayam Institute of
Science & Technology (PRIST)
Deemed to be University
Vallam, Thanjavur - 613 403.



PONNAIYAH RAMAJAYAM INSTITUTE OF
SCIENCE & TECHNOLOGY (PRIST)

Declared as DEEMED TO BE UNIVERSITY
Via 3 of UGC Act, 1956

**SCHOOL OF ARTS AND SCIENCE
DEPARTMENT OF MICROBIOLOGY
CERTIFICATE COURSE ON FOOD PROCESSING
ACADEMIC YEAR 2023-2024**

Syllabus

Subject Code: 22516FP

Value added course: 2

Total: 45 hours

AIM:

The aim of food processing makes food more edible, palatable and safe, and preserves it so it can be eaten beyond the harvest season. Food processing is also a tool that offers greater variety in foods and therefore increases the consumer's choice.

Course Objectives:

CO 1: To get the knowledge about the principles and methods of preservation

CO 2: To know about the freezing and thawing process.

CO3: To know about food Drying/Dehydration

CO4: To get the knowledge of Food Concentration

CO 5: To know about the Membrane Processing

Course Outcome:

CO1: Students will understand the basic concepts in food processing and will get knowledge

CO2: They will understand different freezing methods used in food processing.

CO3: They will understand the drying methods and types of dryers.

CO4: They will understand different Food Concentration methods used in food processing

CO5: They will learn different Membrane Processing.

UNIT 1 (9Hr)

Food processing and preservation principles, method of preservation: pasteurization (definition, time-temperature combination and equipments) sterilization (definition, time-temperature combination and equipments), blanching (definition, time-temperature combination and equipments, adequacy in blanching), canning (definition, time-temperature combination and equipments), packaging (Introduction, Metal Containers, Glass Containers, Rigid Plastic Containers, Retortable Pouches).

UNIT 2 (9Hr)

Food Freezing and thawing process: Introduction, freezing point and freezing rate, comparison of Freezing and thawing process; freezing methods: Air freezing, plate freezing, liquid immersion freezing and cryogenic freezing. Freezer selection. Advantages and disadvantages of freezing. Freezing curve. Freezer selection, advantages and disadvantages of freezing and changes in food during freezing storage.

UNIT 3 (9Hr)

Food Drying/Dehydration: Definition, free and bound moisture, concept of water activity, factors affecting drying, Drying curve (constant rate period and falling rate period), moisture content (wet basis and dry basis), equilibrium moisture content, Drying methods and equipments: sun/solar drying, Cabinet drying, tunnel dryer, spray dryer, freeze dryer, fluidized bed dryer, Nutritional, physico-chemical changes during drying.

UNIT 4 (9Hr)

Food Concentration: Evaporation- Definition, types of evaporator (single effect, double effect and multiple effect evaporator); Freeze concentration- General principles and applications, basic elements, ice crystal nucleation, growth and crystallization, separation techniques (filtration and wash column).

UNIT 5 (9Hr)

Membrane Processing: General principles and advantages, dead end and cross flow, Classification of membrane system: Reverse Osmosis, Nano Filtration, Ultra Filtration, Micro Filtration, Electrodialysis and Pervaporation; Membrane technology comparison chart, Membrane application in the food industries; Membrane performance, and Limitation of membrane processes.

TEXT BOOKS/ REFERENCES:

1. Food Processing: Principles and Applications by Ramaswamy H. & Marcotte M. Taylor & Francis.
2. Food Science by Norman N Potter and Joseph H. Hotchkiss, CBS Publishers and Distributors.
3. Novel Food Processing Technologies by Barbosa-Canovas, Tapia & Cano CRC Press, 2004.

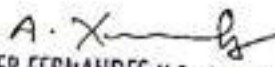

Dr. A. KAVIER FERNANDES, M.Sc. B.Sc. M.Phil. Ph.D.
Assistant Professor
Department of Microbiology
School of Arts & Science
Prst Deemed to be University, Thanjavur.



DEAN
School of Arts & Science
Ponnaiyah Ramajayam Institute of
Science & Technology (PRIST)
Deemed to be University
Vallam, Thanjavur - 613 403.

APPLICATION FORM

1. Full Name
2. Programme
3. Discipline
4. Institution Name
5. Date of Birth
6. Sex (M/F)
7. E-mail
8. Mobile No.
9. Permanent Address

Signature of the Applicant

Submission of Application Form

Submit your Application form in person to the co-ordinator, School of Arts and Science, PRIST University, Thanjavur, Vallam, 613 403.

Application may be sent to

Course Co-ordinator
Department of Microbiology
PRIST Deemed To Be University 613 403.
Email: tech@prist.ac.in

About the University

Ponnaiyah Ramajayam Institute of Science and Technology (PRIST) is a deemed university in Vallam, India. The Institute offers undergraduate and postgraduate courses in Engineering, Science, Education, Management, Arts, and Law, as well as research programmes.

Facilities Available

The University is housed in an independent, multi-story building with state of art equipment, excellent Laboratories and Infrastructure to help complete this course. Majority of scientists have been acting as monitoring the research program. Computer Library with internet facilities for students, Hostel facilities, Health centre, Sports complex, etc.

Department of Microbiology

Microbiology course is very broad where one get to touch and know about all the major areas of life (biological) sciences.

The Microbiology is focusing on some major areas like genetics, biochemistry, cell biology, molecular biology. So this course can provide much firmer hand on Food processing.



PONNAIYAH RAMAJAYAM INSTITUTE OF SCIENCE & TECHNOLOGY (PRIST)
DEEMED TO BE UNIVERSITY
VALLAM, THANJAVUR - 613 403

School of Arts and Science Department of Microbiology

Certificate course
on
Food processing
For admission to the Academic
Year 2023-2024



PRIST Deemed to be University
Thanjavur, Vallam-613 403

INTRODUCTION

Our world is surrounded by several environmental challenges that are becoming troublesome by the day. Therefore, the certificate course in Food Processing by PRIST aims to teach students about these pressing issues by developing in-depth knowledge about this field mainly deals with food science and technologies that are being used to transform raw ingredients into food. Food technology consists of methods such as preservation, packaging and distribution to provide clean and nutritious food for the consumption of humans and animals.

Importance of Food processing

The Food processing offers important benefits to businesses and consumers, including a more varied food supply and foods with a longer shelf life. Critical aspects of food processing, however, take concern over dietary health, worker health, and food safety.

These programs can help individuals and companies develop a comprehensive understanding of food safety including the requirements for a food management system, how to properly manage a food facility, and how to identify and mitigate potential safety risks.

Course Content

- ✓ Fundamentals of Food Processing.
- ✓ Food Microbiology.
- ✓ Food Hygiene and Sanitation.
- ✓ Food Analysis.
- ✓ Concentrated and Dehydrated milk products.
- ✓ Bakery and Confectionary Products.
- ✓ Principles of Fruits and Vegetable Technology.
- ✓ Technology of Spices and Plantation products.

Learning Objectives

- To get the knowledge about the principles and methods of preservation
- To know about the freezing and thawing process.
- To know about food Drying/Dehydration
- To get the knowledge of Food Concentration
- To know about the Membrane Processing

Level of Knowledge Expected

A food technologist needs to be well-versed in the basic principles of food science. They must also know about culinary arts, food storage, and packaging techniques.

Duration of the program

6 hrs add on Certificate course

Course Outcomes

- ◆ Students will understand the basic concepts in food processing and will get knowledge
- ◆ They will understand different freezing methods used in food processing.
- ◆ They will understand the drying methods and types of dryers.
- ◆ They will understand different Food Concentration methods used in food processing.
- ◆ They will learn different Membrane Processing.

Eligibility criteria & Fee Structure

Any graduate shall be eligible for the admission to the course

Certification

The candidates successfully qualifying the course the course shall be awarded a certificate to that effect in the appropriate form by School of Arts and Science, Department of Microbiology, PRIST Deemed To Be University, Thanjavur, Vallam.

A. KAVIER FERNANDES, M.Sc., Ph.D.,
Assistant Professor
Department of Microbiology
School of Arts & Science
PRIST Deemed to be University, Thanjavur.

DEAN
School of Arts & Science
Ponnaiyah Ramajayam Institute of
Science & Technology (PRIST)
Deemed to be University
Vallam, Thanjavur - 613 403.



**PONNAIYAH RAMAJAYAM INSTITUTE OF
SCIENCE & TECHNOLOGY (PRIST)**

Declared as DEEMED TO BE UNIVERSITY
U/s 3 of UGC Act, 1956

**SCHOOL OF ARTS AND SCIENCE
DEPARTMENT OF MICROBIOLOGY
Certificate Course on Clinical Laboratory Technology
ACADEMIC YEAR 2023-2024**

Syllabus

Subject Code: 22516CLT

Value added course: 3

Total: 45 hours

AIM:

The aim of Clinical Laboratory Technology, equips them with the knowledge and skills required to perform laboratory tests, analyze specimens, and contribute to the delivery of quality healthcare services.

Course Objectives:

CO 1: To get the knowledge about the general aspects of laboratory safety

CO 2: To know about the hematology methods.

CO3: To know about sample preparation and processing

CO4: To get the knowledge of biochemical test

CO 5: To know about the different branches of Pharmacology

Course Outcome:

CO1: Students will understand the general aspects of laboratory safety

CO2: They will understand different hematology methods.

CO3: They will understand the sample preparation and processing

CO4: They will understand biochemical test

CO5: They will learn different different branches of Pharmacology

UNIT I General aspects of laboratory safety (9Hr)

Role of Medical Laboratory technologists – ethics of laboratory practice. Laboratory safety –Common lab accidents their prevention and their first aid. Bio-Medical Waste Management - Legal Aspects and Environment Concern

UNIT II Hematology (9Hr)

Various methods of blood collection - Venipuncture and collection of blood samples, Preparation of blood films, staining of blood smears, Manual count of blood cells. Blood components separation – serum and plasma. Haematocrit, ESR, blood volume measurements. RBC, WBC & platelet counts. Functions of RBC, WBC and platelets.

UNIT III Sample preparation and processing (9Hr)

Clinical sample - collection, transport and processing, Examine and analyse of body fluids, tissues and cells. Examination of urine, pus, blood, stool and CSF. Culture media preparation.

UNIT IV Biochemistry (9Hr)

Estimation of serum urea, Creatinine, uric acid, calcium and phosphorus. Demonstration of serum electrophoresis, PCR, ELISA.

UNIT V Pharmacology (9Hr)

Different branches of Pharmacology, Routes of drug administration, Absorption, Distribution, Metabolism and excretion of drugs, Animal used in experiments, Animal handling and ethics.

TEXT BOOKS/ REFERENCES:

1. Bancroft, John D., Christopher Layton, and Kim S. Suvarna, Editors. Bancroft's Theory and Practice of Histological Techniques. 8th ed. Churchill Livingstone/Elsevier, 2019.
2. (NEW EDITION) Bishop, Michael L., Edward P. Fody, and Larry E. Schoeff. Clinical Chemistry: Principles, Techniques, Correlations. 8th ed. Philadelphia, PA: Wolters Kluwer, 2018.
3. Brunzel, Nancy A. Fundamentals of Urine and Body Fluid Analysis. 4th ed. St. Louis, Elsevier/Saunders, 2018.
4. (NEW) Buja, L. Maximilian and Krueger Gerhard R. F. Netter's Illustrated Human Pathology. 2nd ed. Elsevier Saunders, 2014.
5. Callum, Jeannie L., et al. Bloody Easy 4: Blood Transfusions, Blood Alternatives and Transfusion Reactions: A Guide to Transfusion Medicine. 4th ed. Ontario Regional Blood Coordinating Network (ORBCoN), 2016.

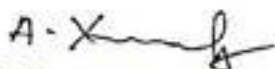

A. XAVIER FERNANDES, M.Sc. B.Sc. M.Phil. Ph.D.
Assistant Professor
Department of Microbiology
School of Arts & Science
Prist Deemed to be University, Thanjavur.



DEAN
School of Arts & Science
Ponnaiyah Ramajayam Institute of
Science & Technology (PRIST)
Deemed to be University
Vallam, Thanjavur - 613 403

APPLICATION FORM

1. Full Name
2. Programme
3. Discipline
4. Institution Name
5. Date of Birth
6. Sex (M/F)
7. E. mail
8. Mobile No.
9. Permanent Address

Signature of the Applicant

Submission of Application Form

Submit your Application form in person to the co-ordinator, School of Arts and Science, PRIST University, Thanjavur, Vallam, 613 403.

Application may be send to
Course Co-Ordinator

Department of Microbiology
PRIST Deemed To Be University 613 403.
E-mail: biotech@prist.ac.in

About the University

Ponnavai Ramajayam Institute of Science and Technology (PRIST) is a deemed university in Tamil Nadu. The institute offers undergraduate and postgraduate courses in Engineering, Science, Education, Management, Arts, and Law, as well as research programmes.

Facilities Available

The University is housed in an independent, multi-story building with state-of-the-art equipment, excellent laboratories and infrastructure to help complete this course. Majority of scientists have been acting as monitoring the research program. Computer Library with internet facilities for students, Hostel facilities, Health centre, Sports complex, etc...

Department of Microbiology

Microbiology course is very broad where one get to teach and know about all the major areas of life (biological) sciences.

The Microbiology is focusing on some major areas like genetics, biochemistry, cell biology, molecular biology. So this course can provide much better hand on Clinical Laboratory Technology.



PONNAVAI RAMAJAYAM INSTITUTE OF SCIENCE & TECHNOLOGY (PRIST)
Deemed to be University
Vallam - 613 403

School of Arts and Science Department of Microbiology

Certificate Course on Clinical Laboratory Technology For admission to the Academic Year 2023-24



PRIST Deemed to be University
Thanjavur, Vallam-613 403

INTRODUCTION

Our world is surrounded by several environmental challenges that are becoming troublesome by the day. Therefore, the online course in Applied Environmental Microbiology by PRIST aims to teach students about these pressing issues by developing in-depth knowledge about microbial processes and communities, found in built and natural environments. The program holds impeccable industry support from numerous water and wastewater treatment organizations, Biotechnological companies, and Bioremediation entities.

Importance of Clinical Laboratory Technology

Medical laboratory technologists, often referred to as clinical laboratory Technology used to diagnose diseases, monitor patient health, and track the effectiveness of treatment. Medical laboratory technologists also play a role in research and development, working to develop new tests and improve the accuracy and efficiency of existing tests.

Course Content

- ◆ General aspects of laboratory safety
- ◆ Hematology
- ◆ Sample preparation and processing
- ◆ Biochemistry
- ◆ Pharmacology

Objective the Program

- ◆ Students will understand the general aspects of laboratory safety
- ◆ To understand different hematology methods.
- ◆ To understand the sample preparation and processing
- ◆ To understand biochemical test
- ◆ To learn different different branches of Pharmacology

Level of Knowledge Expected

Students studying Medical Laboratory Technology course gain expertise in areas such as Clinical Chemistry, Hematology, Microbiology, Immunology, and Molecular Biology.

Duration of the program

45 hrs add on Certificate course

Course Outcome

Develop analysis and synthesis skills. Obtain information, design experiments and interpret results. Students will understand the general aspects of laboratory safety, different hematology methods, sample preparation, processing, biochemical test and different different branches of Pharmacology

Eligibility criteria & Fee Structure

Any graduate shall be eligible for the admission to the course

Certification

The candidates successfully qualifying the course the course shall be awarded a certificate to that effect in the appropriate form by School of Arts and Science, Department of Microbiology, PRIST Deemed To Be University, Thanjavur, Vallam.

Dr. A. KAVIER FERNANDES, M.Sc. M.Phil. Ph.D.,
Assistant Professor
Department of Microbiology
School of Arts & Science
Prist Deemed to be University, Thanjavur.

DEAN
School of Arts & Science
Ponnavai Ramajayam Institute of
Science & Technology (PRIST)
Deemed to be University
Vallam, Thanjavur - 613 403



PONNAIYAH RAMAJAYAM INSTITUTE OF
SCIENCE & TECHNOLOGY (PRIST)

Declared as DEEMED TO BE UNIVERSITY
Uis 3 of UGC Act, 1956

**SCHOOL OF ARTS AND SCIENCE
DEPARTMENT OF MICROBIOLOGY**

**Diploma in Seaweed Culture
ACADEMIC YEAR 2023-2024**

Syllabus

Subject Code: 23516SC

Total: 90 hours

Value added course: 4

Course objectives:

To study the morphology and types of Seaweeds. To understand the Seaweed cultivation methods.

To be aware of the identification of commercially important Seaweeds. To identify the nutrient value of Seaweeds.

To facilitate self-employment scope of seaweed cultivation in small scale industry.

Course Outcome

After completion of the course, students will be able to identify the marine macro algae and their global status. analyze the importance of physico-chemical parameters in seaweeds learn the culture techniques of seaweeds understand the byproducts from seaweeds discuss the central and state schemes for seaweed farming

UNIT I

Introduction – Seaweed morphology; Classification and distribution of seaweeds; life cycle of seaweeds. Identification of cultivable seaweeds – Global status – Present trend and scope in India and Tamil Nadu

UNIT II

Seaweed Farming Infrastructure – Seaweed spores collection — Site selection – Physico-chemical parameters - site preparation – Farming methods - Construction specifications for cultivable species – Raft and rack culture site selection – design and operation of the systems

UNIT III

Seaweed cultivation methods, Bamboo Raft, Monoline, Tube nets - Raft preparation and installation – mooring system - maintenance of seaweeds Raft; Seaweed Cultivation period; Farm management harvesting method and preservation of seaweeds – post harvest technology

Unit IV

Seaweed Byproducts – Phytochemicals – Agar – agarose - carrageenan – Algin – Seaweed polysaccharides – sources and use - Seaweed as food – Nori – Kombu – Wakame – Seaweed Compost – Seaweed liquid fertilizer – Agricultural biostimulants – animal fodder.

UNIT V

Role of seaweed in Blue economy - .PMSSY in seaweeds – seaweed based industries in India - CSMCRI – Subsidy for seaweed farming – seaweed cultivation as livelihood.

References:

- ❖ John, B., (2023) Seaweeds of the World: A Guide to Every Order. Princeton University Press 249pp. Leonel, P. (2016) Edible seaweeds of the world Taylor & Francis 463pp.
- ❖ Leonel, P., Kiril, B., and Joshi N. H. (eds) (2019) Seaweeds as Plant Fertilizer, Agricultural Biostimulants and Animal Fodder. CRC Press 233pp.
- ❖ Ole G. Mouritsen, Jonas Drotner Mouritsen, Mariela Johansen (2013) Seaweeds: Edible, Available, and Sustainable 3rd edition. University Of Chicago Press 304pp.

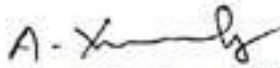

A. Xavier,
Assistant Professor,
Department of Microbiology
School of Arts & Science
PRIST Deemed to be University, Thanjavur.



DEAN
School of Arts & Science
Annalayah Ramajayam Institute of
Science & Technology (PRIST)
Deemed to be University
Thanjavur, Thanjavur - 613 453.

APPLICATION FORM

1. Full Name
2. Programme
3. Discipline
4. Institution Name
5. Date of Birth
6. Sex (M/F)
7. E. mail
8. Mobile No.
9. Permanent Address

Signature of the Applicant

Submission of Application Form

Submit your Application form in person to the co-ordinator, School of Arts and Science, PRIST University, Thanjavur, Vallam, 612 403.

Application may be sent to

Course Co-Ordinator
Department of Microbiology
PRIST Deemed To Be University 612 403.
E-mail: bioart@prist.ac.in

About the University

Ponnayiah Ramajayam Institute of Science and Technology (PRIST) is a deemed university in Vallam, India. The Institute offers undergraduate and postgraduate courses in Engineering, Science, Education, Management, Arts, and Law, as well as research programmes.

Facilities Available

The University is housed in an independent, multi-storied building with state-of-the-art equipment, excellent laboratories and infrastructure to help complete this course. Majority of scientists have been acting as mentors in the research program. Computer Library with internet facilities for students, Hostel facilities, Health center, Sports complex, etc.

Department of Microbiology

Microbiology course is very broad where one gets to touch and know about all the major areas of life (biological) sciences.

The Microbiology is focusing on some major areas like genetics, biochemistry, cell biology, molecular biology. So this course can provide much better fund on Seaweed Culture



PONNAYIAH RAMAJAYAM INSTITUTE OF SCIENCE & TECHNOLOGY (PRIST)
Deemed to be University
Vallam, Thanjavur - 612 403

School of Arts and Science Department of Microbiology

Diploma in Seaweed Culture For admission to the Academic Year 2023-24



PRIST Deemed to be University
Thanjavur, Vallam-612 403

INTRODUCTION

Our world is surrounded by several environmental challenges that are becoming troublesome by the day. Therefore, the online course in seaweed culture by PRIST the aim of seaweed culture is to sustainably produce seaweed for various industries while enhancing marine ecosystems and supporting coastal livelihoods. It seeks to promote environmental conservation, economic development, and food security through responsible cultivation practices.

Importance of seaweed culture

Seaweed culture is vital for environmental sustainability, as it improves water quality, sequesters carbon, and protects coastlines. It also supports coastal economies by creating jobs and supplying raw materials for various industries like food, biofuels, and cosmetics.

Course Content

- ◆ Types of Seaweed
- ◆ Ecological Role of Seaweeds
- ◆ Seaweed Farming Techniques
- ◆ Seaweed Processing and Value-Added Products
- ◆ Economic and Social Aspects of Seaweed Farming

Objective the Program

- ◆ To cultivate seaweed as a renewable resource for food, biofuels, cosmetics, pharmaceuticals, and other industries, reducing reliance on wild populations and ensuring long-term availability.
- ◆ To enhance marine ecosystems by absorbing excess nutrients, improving water quality, sequestering carbon, and protecting coastlines from erosion, contributing to climate change mitigation and ecosystem health.

Level of Knowledge Expected

A foundational understanding of microbiology, food science, and fermentation processes is expected for students in the seaweed culture.

Duration of the program

45 hrs add on Certificate course

Course Outcome

The outcome of seaweed culture includes sustainable production of seaweed for diverse industries and improved marine ecosystems through enhanced water quality and carbon sequestration. It also leads to economic growth and livelihood opportunities for coastal communities.

Eligibility criteria & Fee Structure

Any graduate shall be eligible for the admission to the course

Certification

The candidates successfully qualifying the course the course shall be awarded a certificate to that effect in the appropriate form by School of Arts and Science, Department of Microbiology, PRIST Deemed To Be University, Thanjavur, Vallam.

A. Xavier
A. XAVIER FERNANDES, M.Sc. Ph.D.
Assistant Professor
Department of Microbiology
School of Arts & Science
PRIST Deemed to be University, Thanjavur.

DEAN
School of Arts & Science
Ponnayiah Ramajayam Institute of
Science & Technology (PRIST)
Deemed to be University
Vallam, Thanjavur - 612 403



PONNAIYAH RAMAJAYAM INSTITUTE OF
SCIENCE & TECHNOLOGY (PRIST)

Declared as DEEMED TO BE UNIVERSITY
Dir 3 of UGC Act, 1956

SCHOOL OF ARTS AND SCIENCE
DEPARTMENT OF MICROBIOLOGY

CIRCULAR

29.01.2024

This is to inform all Life science students that the value added courses classes for academic year 2023-24 even semester will commence from 01.02.2024. Hence requesting all registered students to attend the classes without fail.

1. Certificate Course in Advances in Plant Tissue Culture - 23516APTC

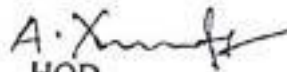
HOD



DEAN

DEAN

School of Arts & Sciences
Ponnaiyah Ramajayam Institute of
Science & Technology (PRIST)
Deemed to be University
Vallam, Thanjavur - 613 402.

Copy to:

1. Hon'ble Vice Chancellor (for your kind information)
2. Registrar
3. Registrar office
4. Dean
5. Department file



PONNAIYAH RAMAJAYAM INSTITUTE OF
SCIENCE & TECHNOLOGY (PRIST)

Declared as DEEMED TO BE UNIVERSITY
U/s 3 of UGC Act, 1956

SCHOOL OF ARTS AND SCIENCE
DEPARTMENT OF MICROBIOLOGY
Certificate Course in Advances in Plant Tissue Culture

ACADEMIC YEAR 2023-2024

Subject Code: 23516APTC

Value added course: 5

Total: 45 hours

Course objectives:

The student completing the course is able to classify various life forms of plants, design and execute experiments related to basic studies on ecology, physiology, biochemistry, plant interactions with microbes and insects, morphology, anatomy, reproduction, genetics, microbiology, molecular biology, recombinant DNA.

Course outcome:

Plant Tissue culture is an important tool for both basic and applied aspects of plant biotechnology as well as its commercial applications. All techniques are skill based and upon systematic learning, can equip a person to effectively utilize the techniques in various areas like basic research, environmental issues and commercial applications. It is a valuable tool for research on morphogenesis, cell signaling, physiology, and molecular biology, as well as crop improvement by biotechnology. This course offers a comprehensive hands-on training for learning the basics with an insight to laboratory practices along with exposure to "lab-to-land" transfers.

Unit I: Plant Tissue Culture(9Hr)

- ❖ Introduction. History. Scope. Advantages. Applications. Limitations.
- ❖ Guidelines for establishing academic and commercial laboratories.
- ❖ Steps involved in Plant Tissue Culture. Various nutrient medium composition.
- ❖ Plant growth regulators and their role in nutrient media. Types of organ cultures and their applications.
- ❖ Pathways of regeneration. Micrografting of commercially important plants. In vitro approaches for crop improvement. Plant cell reactors. Microtechniques

Unit II: Micropropagation(9Hr)

- ❖ Meristem culture for the production of virus free plants. Nucellus culture for clonal propagation and large scale multiplication.
- ❖ Strategies of Micropropagation. Stages of micropropagation by axillary shoot proliferation in Monocots and Dicots.

- ❖ Stages in micropropagation via direct and indirect organogenesis. Stages in micropropagation via direct and indirect somatic embryogenesis. Low cost methods for micropropagation.

Unit III: Practicals in Plant Tissue Culture (9Hr)

- ❖ Handling and Instrumentation of Plant Tissue Culture. Glassware Washing & Sterilization Techniques. Preparation of stock solutions and nutrient media.
- ❖ Surface sterilization of Explants. Monocot and Dicot Seed cultures for the establishment of organ cultures. Establishment of organ cultures for the induction of callus
- ❖ Establishment of organ cultures for the induction of multiple shoots. Sub-culturing of nucellar seedlings for clonal propagation.

Unit IV: Practicals in Plant Tissue Culture (9Hr)

- ❖ Technique of micrografting in fruit crops. Primary hardening of tissue culture plants for their acclimatization. Cytological study of calli cells and their subculturing
- ❖ Establishment of embryogenic/ non embryogenic cell suspension cultures. Embryo / Endosperm/ Ovules and other Cultures.

Unit V: Practicals in Micropropagation (9Hr)

- ❖ Demonstration of meristematic explants in different plants
- ❖ Preparation of mother plants for collection of explants
- ❖ In vitro and ex vitro rooting of microshoots.
- ❖ Primary and secondary hardening of tissue cultured plants.
- ❖ Artificial seed production from microshoots and their in vitro germination.
- ❖ Establishment of cultures for the induction of embryogenic callus.

References:

1. An introduction to plant biotechnology by H. S. Chawala.
2. Biotechnology in crop improvement by H. S. Chawala, International book distributing co. Luknow.
3. Plant Biotechnology – Practical Manual by C. C. Giri and Archana Giri, I. K. International Publishing house, Mumbai.
4. Biotechnology by B. D. Singh, Kalyani publishers.

A. Xavier

A. XAVIER FERNANDES, M.Sc. in Microbiology
Assistant Professor,
Department of Microbiology
School of Arts & Science
Prist Deemed to be University, Thanjavur.

[Signature]

DEAN
School of Arts & Science
Sonnaiyah Ramajayam Institute
Science & Technology (PRIST)
Deemed to be University
Thanjavur - 613 403

APPLICATION FORM

1. Full Name
2. Programme
3. Discipline
4. Institution Name
5. Date of Birth
6. Sex (M/F)
7. E-mail
8. Mobile No.
9. Permanent Address

Signature of the Applicant

Submission of Application Form

Submit your Application form in person to the co-ordinator, School of Arts and Science, PRIST University, Thanjavur, Vallam, 613 403.

Application may be send to
Course Co-Ordinator

Department of Microbiology
PRIST Deemed To be University 613 403
E-mail: admission@prist.ac.in

About the University

Ponnamyah Ramajayam Institute of Science and Technology (PRIST) is a deemed university in Vallam, India. The Institute offers undergraduate and postgraduate courses in Engineering, Science, Education, Management, Arts, and Law, as well as research programmes.

Facilities Available

The University is housed in an independent, multi-storing building with state of art equipment, excellent Laboratories and infrastructure to help complete this course. Majority of scientists have been acting as monitoring the research program. Computer Library with internet facilities for students, Hostel facilities, Health centre, Sports complex, etc....

Department of Microbiology

Microbiology course is very broad where you get to touch and know about all the major areas of life (biological) sciences.

The Microbiology is focusing on some major areas like genetics, biochemistry, cell biology, molecular biology. So this course can provide much better based on Clinical Laboratory Technology.



Ponnamyah Ramajayam Institute of Science & Technology (PRIST)
Deemed to be University
Vallam, Thanjavur

School of Arts and Science Department of Microbiology

Certificate Course
in
Advances in Plant Tissue Culture
For admission to the
Academic Year
2023-24



PRIST Deemed to be University
Thanjavur, Vallam-613 403

INTRODUCTION

Our world is surrounded by several environmental challenges that are becoming troublesome by the day. Therefore, the online course in Advance in Plant Tissue Culture By PRIST aims to teach students about the techniques used to maintain or grow plant cells, tissues, or organs under sterile conditions on a nutrient culture medium of known composition. It is widely used to produce clones of a plant in a method known as micropropagation.

Importance of Plant Tissue Culture

Plant tissue culture is a technique that has been around for more than 30 years. Tissue culture is seen as an important technology for developing countries for the production of disease-free, high quality planting material and the rapid production of many uniform plants.

Course Content

- ◆ Plant Tissue Culture
- ◆ Micropropagation
- ◆ Practicals in Plant Tissue Culture
- ◆ Practicals in Plant Tissue Culture
- ◆ Practicals in Micropropagation

Objective the Program

The student completing the course is able to classify various life forms of plants, design and execute experiments related to basic studies on ecology, physiology, biochemistry, plant interactions with microbes and insects, morphology, anatomy, reproduction, genetics, microbiology, molecular biology, recombinant DNA.

Level of Knowledge Expected

Students studying Plant Tissue culture is defined as culturing plant seeds, organs, explants, tissues, cells, or protoplasts on a chemically defined synthetic nutrient media under sterile and controlled conditions of light, temperature, and humidity.

Duration of the program

45 hrs add on Certificate course

Course Outcome

Plant Tissue Culture is an important tool for both basic and applied aspects of plant tissue biology as well as its commercial applications. All techniques are skill based and upon systematic learning, can equip a person to effectively utilize the techniques in various areas like basic research, environmental issues and commercial applications.

Eligibility criteria & Fee Structure

Any graduate shall be eligible for the admission to the course.

Certification

The candidates successfully qualifying the course the course shall be awarded a certificate to that effect in the appropriate form by School of Arts and Science, Department of Microbiology, PRIST Deemed To be University, Thanjavur, Vallam.

A. Xavier

A. XAVIER FERNANDES, M.Sc. M.Phil. M.D.,
Assistant Professor,
Department of Microbiology
School of Arts & Science
PRIST Deemed to be University, Thanjavur.

[Signature]

School of Arts & Science
Ponnamyah Ramajayam Institute of
Science & Technology (PRIST)
Deemed to be University
Vallam, Thanjavur - 613 403.



PONNAIYAH RAMAJAYAM INSTITUTE OF
SCIENCE & TECHNOLOGY (PRIST)

Declared as DEEMED TO BE UNIVERSITY
Sl. 3 of UGC Act, 1956

School of Arts and Science
Department of Microbiology

Certificate Course in Biofertilizer Production Technology

Academic Year 2023-2024

ODD semester

S.No	Date	I hour 2.30-3.30 pm	2 hour 3.30-4.30 pm
1.	12.7.23	Dr.N.Mahalakshmi	DR. T.USHADEVI
2.	13.7.23	DR. T.USHADEVI	Dr.N.Mahalakshmi
3.	14.7.23	Dr.N.Mahalakshmi	DR. T.USHADEVI
4.	15.7.23	DR. T.USHADEVI	Dr.N.Mahalakshmi
5.	16.7.23	Dr.N.Mahalakshmi	DR. T.USHADEVI
6.	19.7.23	DR. T.USHADEVI	Dr.N.Mahalakshmi
7.	20.7.23	Dr.N.Mahalakshmi	DR. T.USHADEVI
8.	21.7.23	DR. T.USHADEVI	Dr.N.Mahalakshmi
9.	22.7.23	Dr.N.Mahalakshmi	DR. T.USHADEVI
10.	23.7.23	DR. T.USHADEVI	Dr.N.Mahalakshmi
11.	26.7.23	Dr.N.Mahalakshmi	DR. T.USHADEVI
12.	27.7.23	DR. T.USHADEVI	Dr.N.Mahalakshmi
13.	28.7.23	Dr.N.Mahalakshmi	DR. T.USHADEVI
14.	03.08.23	DR. T.USHADEVI	Dr.N.Mahalakshmi
15.	04.08.23	Dr.N.Mahalakshmi	DR. T.USHADEVI
16.	05.08.23	DR. T.USHADEVI	Dr.N.Mahalakshmi
17.	06.08.23	Dr.N.Mahalakshmi	DR. T.USHADEVI
18.	07.08.23	DR. T.USHADEVI	Dr.N.Mahalakshmi
19.	10.08.23	Dr.N.Mahalakshmi	DR. T.USHADEVI
20.	11.08.23	DR. T.USHADEVI	Dr.N.Mahalakshmi
21.	12.08.23	Dr.N.Mahalakshmi	DR. T.USHADEVI

22.	13.08.23	Dr.N.Mahalakshmi	DR. T.USHADEVI
23.	14.08.23	DR. T.USHADEVI	Dr.N.Mahalakshmi
24.	17.08.23	Dr.N.Mahalakshmi	DR. T.USHADEVI
25.	18.08.23	DR. T.USHADEVI	Dr.N.Mahalakshmi
26.	19.08.23	Dr.N.Mahalakshmi	DR. T.USHADEVI
27.	20.08.23	DR. T.USHADEVI	Dr.N.Mahalakshmi
28.	21.08.23	Dr.N.Mahalakshmi	
29.	24.08.23	DR. T.USHADEVI	
30.	25.08.23	Dr.N.Mahalakshmi	

A. Xavier
HOD

Dr.A.XAVIER FERNANDES, M.Sc. B.Sc. B.Ph.D.,
Assistant Professor
Department of Microbiology
School of Arts & Science
Prst Deemed to be University, Thanjavur.

[Signature]

DEAN

DEAN
School of Arts & Science
Gonnaiyah Ramalingam Institute of
Science & Technology (PRIST)
Deemed to be University
Vallam, Thanjavur - 613 403



PONNAIYAH RAMAJAYAM INSTITUTE OF
SCIENCE & TECHNOLOGY (PRIST)

Declared as DEEMED TO BE UNIVERSITY
Ute 3 of UGC Act, 1956

School of Arts and Science
Department of Microbiology

Certificate Course in Biofertilizer Production Technology

Students Enrolled List
Academic Year 2023-2024

S.No	Reg.No	Name of the students
1.	2101MB10101	N Pravinkumar
2.	2101MB10102	K.Rajkumar
3.	2101MB10103	R.Raghul
4.	2101MB10104	V.Hariharan
5.	2101MB10105	R.Soorya
6.	2101MB10106	G.Raghul
7.	2101MB10107	S.Akash
8.	2101MB10108	Saminathan P
9.	2101MB10109	Muhilan
10.	2101MB10201	A.Afisha Rameeza
11.	2101MB10202	K.Sathya
12.	2101MB10203	K.Pragatheeswari
13.	2101MB10204	T.Nalini
14.	2101MB10205	E.Rajeswari
15.	2101MB10206	A.Amirtha

HOD

Dr.A.KAVIER FERNANDES, M.Sc., M.A., M.Phil., Ph.D.,
Assistant Professor
Department of Microbiology
School of Arts & Science

Prist Deemed to be University, Thanjavur.



DEAN
DEAN
School of Arts & Science
Ponnaiyah Ramajayam Institute of
Science & Technology (PRIST)
Deemed to be University
Valurthi, Thanjavur 612 403



**School of Arts and Science
Department of Microbiology
Certificate Course in Biofertilizer Production Technology
Students Attendance - Academic Year 2023-2024**

S.No	Reg.No	Name of the Student	12.7.23	13.7.23	14.7.23	15.7.23	16.7.23	19.7.23	20.7.23	21.7.23	22.7.23	23.7.23	26.7.23	27.7.23	28.7.23	03.08.23	04.08.23	05.08.23	06.08.23	07.08.23	10.08.23	11.08.23	12.08.23	13.08.23	14.08.23	17.08.23	18.08.23	19.08.23	20.08.23	21.08.23	24.08.23	25.08.23				
1.	2101MB10101	N Pravinkumar	P	P	P	P	P	P	P	P	P	P	P	P	P	P	P	P	P	P	P	P	P	P	P	P	P	P	P	P	P	P	P			
2.	2101MB10102	K.Rajkumar	P	P	P	P	P	P	P	P	P	P	P	P	P	P	P	P	P	P	P	P	P	P	P	P	P	P	P	P	P	P	P	P		
3.	2101MB10103	R.Raghul	P	P	P	P	P	P	P	P	P	P	P	P	P	P	P	P	P	P	P	P	P	P	P	P	P	P	P	P	P	P	P	P		
4.	2101MB10104	V.Hariharan	P	P	P	P	P	P	P	P	P	P	P	P	P	P	P	P	P	P	P	P	P	P	P	P	P	P	P	P	P	P	P	P		
5.	2101MB10105	R.Soorya	P	P	P	P	P	P	P	P	P	P	P	P	P	P	P	P	P	P	P	P	P	P	P	P	P	P	P	P	P	P	P	P	P	
6.	2101MB10106	G.Raghul	P	P	P	P	P	P	P	P	P	P	P	P	P	P	P	P	P	P	P	P	P	P	P	P	P	P	P	P	P	P	P	P	P	
7.	2101MB10107	S.Akash	A	P	P	P	P	P	P	P	P	P	P	P	P	P	P	P	P	P	P	P	P	P	P	P	P	P	P	P	P	P	P	P	P	
8.	2101MB10108	Saminathan P	P	P	P	P	P	P	P	P	P	P	P	P	P	P	P	P	P	P	P	P	P	P	P	P	P	P	P	P	P	P	P	P	P	
9.	2101MB10109	Muhilan	P	P	P	P	P	P	P	P	P	P	P	P	P	P	P	P	P	P	P	P	P	P	P	P	P	P	P	P	P	P	P	P	P	
10.	2101MB10201	A.Afisha Rameeza	P	P	P	P	P	P	P	P	P	P	P	P	P	P	P	P	P	P	P	P	P	P	P	P	P	P	P	P	P	P	P	P	P	P
11.	2101MB10202	K.Sathiya	P	P	P	P	P	P	P	P	P	P	P	P	P	P	P	P	P	P	P	P	P	P	P	P	P	P	P	P	P	P	P	P	P	P
12.	2101MB10203	K.Pragatheeswari	P	P	P	P	P	P	P	P	P	P	P	P	P	P	P	P	P	P	P	P	P	P	P	P	P	P	P	P	P	P	P	P	P	P
13.	2101MB10204	T.Nalini	P	P	P	P	P	P	P	P	P	P	P	P	P	P	P	P	P	P	P	P	P	P	P	P	P	P	P	P	P	P	P	P	P	P
14.	2101MB10205	E.Rajeswari	P	P	P	P	P	P	P	P	P	P	P	P	P	P	P	P	P	P	P	P	P	P	P	P	P	P	P	P	P	P	P	P	P	P
15.	2101MB10206	A.Amirtha	P	P	P	P	P	P	P	P	P	P	P	P	P	P	P	P	P	P	P	P	P	P	P	P	P	P	P	P	P	P	P	P	P	P

A. Xavier
Dr.A.XAVIER FERNANDES, M.Sc., Ph.D., M.Phil., M.D.,
 Assistant Professor
 Department of Microbiology
 School of Arts & Science
 Ponnaiyah Ramajayam Institute of Science & Technology (PRIST)
 Deemed to be University
 Vallam, Thanjavur - 613 403.

A. Xavier
Dr.A.XAVIER FERNANDES, M.Sc., Ph.D., M.Phil., M.D.,
 Assistant Professor
 Department of Microbiology
 School of Arts & Science
 Ponnaiyah Ramajayam Institute of Science & Technology (PRIST)
 Deemed to be University, Thanjavur.



PONNAIYAH RAMAJAYAM INSTITUTE OF
SCIENCE & TECHNOLOGY (PRIST)

Declared as DEEMED TO BE UNIVERSITY
Uin 3 of UGC Act, 1956

School of Arts and Science
Department of Microbiology

CERTIFICATE COURSE ON FOOD PROCESSING
Academic Year 2023-2024
ODD semester

<u>S.No</u>	<u>Date</u>	<u>1 hour 2.30-3.30 pm</u>	<u>2 hour 3.30-4.30 pm</u>
1.	12.7.23	Dr.R.Sathya	Dr. A.Xavier Fernandes
2.	13.7.23	Dr. A.Xavier Fernandes	Dr.R.Sathya
3.	14.7.23	Dr.R.Sathya	Dr. A.Xavier Fernandes
4.	15.7.23	Dr. A.Xavier Fernandes	Dr.R.Sathya
5.	16.7.23	Dr.R.Sathya	Dr. A.Xavier Fernandes
6.	19.7.23	Dr. A.Xavier Fernandes	Dr.R.Sathya
7.	20.7.23	Dr.R.Sathya	Dr. A.Xavier Fernandes
8.	21.7.23	Dr. A.Xavier Fernandes	Dr.R.Sathya
9.	22.7.23	Dr.R.Sathya	Dr. A.Xavier Fernandes
10.	23.7.23	Dr. A.Xavier Fernandes	Dr.R.Sathya
11.	26.7.23	Dr.R.Sathya	Dr. A.Xavier Fernandes
12.	27.7.23	Dr. A.Xavier Fernandes	Dr.R.Sathya
13.	28.7.23	Dr.R.Sathya	Dr. A.Xavier Fernandes
14.	03.08.23	Dr. A.Xavier Fernandes	Dr.R.Sathya
15.	04.08.23	Dr.R.Sathya	Dr. A.Xavier Fernandes
16.	05.08.23	Dr. A.Xavier Fernandes	Dr.R.Sathya
17.	06.08.23	Dr.R.Sathya	Dr. A.Xavier Fernandes
18.	07.08.23	Dr. A.Xavier Fernandes	Dr.R.Sathya
19.	10.08.23	Dr.R.Sathya	Dr. A.Xavier Fernandes
20.	11.08.23	Dr. A.Xavier Fernandes	Dr.R.Sathya
21.	12.08.23	Dr.R.Sathya	Dr. A.Xavier Fernandes

22.	13.08.23	Dr. A.Xavier Fernandes	Dr.R.Sathya
23.	14.08.23	Dr.R.Sathya	Dr. A.Xavier Fernandes
24.	17.08.23	Dr. A.Xavier Fernandes	Dr.R.Sathya
25.	18.08.23	Dr.R.Sathya	Dr. A.Xavier Fernandes
26.	19.08.23	Dr. A.Xavier Fernandes	Dr.R.Sathya
27.	20.08.23	Dr.R.Sathya	Dr. A.Xavier Fernandes
28.	21.08.23	Dr.R.Sathya	
29.	24.08.23	Dr. A.Xavier Fernandes	
30.	25.08.23	Dr.R.Sathya	

HOD

Dr.A.XAVIER FERNANDES, M.Sc. B.Ed. M.Phil. Ph.D.
Assistant Professor
Department of Microbiology
School of Arts & Science
Prist Deemed to be University, Thanjavur.



DEAN

DEAN
School of Arts & Science
Ponnalysh Ramajayam Institute of
Science & Technology (PRIST)
Deemed to be University
Thanjavur - 612 013.



PONNAIYAH RAMAJAYAM INSTITUTE OF
SCIENCE & TECHNOLOGY (PRIST)

Declared as DEEMED TO BE UNIVERSITY
Via 3 of UGC Act, 1956

School of Arts and Science
Department of Microbiology

CERTIFICATE COURSE ON FOOD PROCESSING
Students Enrolled List
Academic Year 2023-2024

S.No	Reg.No	Name of the students
1.	2101MB10207	C.Sneha
2.	2101MB10208	K.Sivapriya
3.	2101MB10209	S.Mahalakshmi
4.	2101MB10210	R.Chandraleka
5.	2101MB10110	P.Prabu
6.	2101MB10111	K.Kavi Chandran
7.	2101MB10202	B.Subhahini
8.	2101MB10112	S.Parameshwaran
9.	2101MB10201	A.Dhanalakshmi
10.	2101MB10202	S.Sushmitha
11.	2101MB10113	P.Bharathi Dasan
12.	2101MB10114	M.Rajendran
13.	2101MB10115	A.Sunilkumar
14.	2101MB10116	S.Vijay
15.	2101MB10117	R.Ram Kumar

HOD
Dr.A.XAVIER FERIANDES, M.Sc., M.Phil., Ph.D.,
Assistant Professor
Department of Microbiology
School of Arts & Sciences

DEAN
DEAN
School of Arts & Sciences
Ponnaiyah Ramajayam Institute of
Science & Technology (PRIST)
Deemed to be University
Vallam, Thanjavur - 613 403.



**School of Arts and Science
Department of Microbiology
Certificate Course on Food Processing
Students Attendance - Academic Year 2023-2024**

S.NO	REG.NO	Name Of The Student	12.7.23	13.7.23	14.7.23	15.7.23	16.7.23	19.7.23	20.7.23	21.7.23	22.7.23	23.7.23	26.7.23	27.7.23	28.7.23	03.08.23	04.08.23	05.08.23	06.08.23	07.08.23	10.08.23	11.08.23	12.08.23	13.08.23	14.08.23	17.08.23	18.08.23	19.08.23	20.08.23	21.08.23	24.08.23	25.08.23			
1	2101MB10207	C.Sneha	P	P	P	P	P	P	P	P	P	P	P	P	P	P	P	P	P	P	P	P	P	P	P	P	P	P	P	P	P	P	P		
2	2101MB10208	K.Sivapriya	P	P	P	P	P	P	P	P	P	P	P	P	P	P	P	P	P	P	P	P	P	P	P	P	P	P	P	P	P	P	P	P	
3	2101MB10209	S.Mahalakshmi	P	P	P	P	P	P	P	P	P	P	P	P	P	P	P	P	P	P	P	P	P	P	P	P	P	P	P	P	P	P	P	P	
4	2101MB10210	R.Chandrika	P	P	P	P	P	P	P	P	P	P	P	P	P	P	P	P	P	P	P	P	P	P	P	P	P	P	P	P	P	P	P	P	
5	2101MB10110	P.Prabu	P	P	P	P	P	P	P	P	P	P	P	P	P	P	P	P	P	P	P	P	P	P	P	P	P	P	P	P	P	P	P	P	
6	2101MB10111	K.Kavi Chandran	P	P	P	P	P	P	P	P	P	P	P	P	P	P	P	P	P	P	P	P	P	P	P	P	P	P	P	P	P	P	P	P	P
7	2101MB10202	B.Subrahini	A	P	P	P	P	P	P	P	P	P	P	P	P	P	P	P	P	P	P	P	P	P	P	P	P	P	P	P	P	P	P	P	P
8	2101MB10112	S.Parameshwaran	P	P	P	P	P	P	P	P	P	P	P	P	P	P	P	P	P	P	P	P	P	P	P	P	P	P	P	P	P	P	P	P	P
9	2101MB10201	A.Dhanalakshmi	P	P	P	P	P	P	P	P	P	P	P	P	P	P	P	P	P	P	P	P	P	P	P	P	P	P	P	P	P	P	P	P	P
10	2101MB10202	S.Sushmita	P	P	P	P	P	P	P	P	P	P	P	P	P	P	P	P	P	P	P	P	P	P	P	P	P	P	P	P	P	P	P	P	P
11	2101MB10113	P.Bharathi Dasan	P	P	P	P	P	P	P	P	P	P	P	P	P	P	P	P	P	P	P	P	P	P	P	P	P	P	P	P	P	P	P	P	P
12	2101MB10114	M.Rajendran	P	P	P	P	P	P	P	P	P	P	P	P	P	P	P	P	P	P	P	P	P	P	P	P	P	P	P	P	P	P	P	P	P
13	2101MB10115	A.Sanilkumar	P	P	P	P	P	P	P	P	P	P	P	P	P	P	P	P	P	P	P	P	P	P	P	P	P	P	P	P	P	P	P	P	P
14	2101MB10116	S.Vijay	P	P	P	P	P	P	P	P	P	P	P	P	P	P	P	P	P	P	P	P	P	P	P	P	P	P	P	P	P	P	P	P	P
15	2101MB10117	R.Ram Kumar	P	P	P	P	P	P	P	P	P	P	P	P	P	P	P	P	P	P	P	P	P	P	P	P	P	P	P	P	P	P	P	P	P

DEAN
School of Arts & Science
Ponnaiyah Ramajayam Institute of
Science & Technology (PRIST)
Deemed to be University
Vallam, Thanjavur - 613 403.

Dr.A.JAVIER FERNANDES, B.Sc., M.Phil., Ph.D.,
Assistant Professor
Department of Microbiology
School of Arts & Science
Prist Deemed to be University, Thanjavur.



PONNAIYAH RAMAJAYAM INSTITUTE OF
SCIENCE & TECHNOLOGY (PRIST)

Declared as DEEMED TO BE UNIVERSITY
Slit 3 of UGC Act, 1956

School of Arts and Science
Department of Microbiology

Certificate Course on Clinical Laboratory Technology
Academic Year 2023-2024
ODD semester

S.No	Date	1 hour 2.30-3.30 pm	2 hour 3.30-4.30 pm
1.	12.7.23	Dr. T.Thiruselvi	Dr.AMBIKA K
2.	13.7.23	Dr.AMBIKA K	Dr. T.Thiruselvi
3.	14.7.23	Dr. T.Thiruselvi	Dr.AMBIKA K
4.	15.7.23	Dr.AMBIKA K	Dr. T.Thiruselvi
5.	16.7.23	Dr. T.Thiruselvi	Dr.AMBIKA K
6.	19.7.23	Dr.AMBIKA K	Dr. T.Thiruselvi
7.	20.7.23	Dr. T.Thiruselvi	Dr.AMBIKA K
8.	21.7.23	Dr.AMBIKA K	Dr. T.Thiruselvi
9.	22.7.23	Dr. T.Thiruselvi	Dr.AMBIKA K
10.	23.7.23	Dr.AMBIKA K	Dr. T.Thiruselvi
11.	26.7.23	Dr. T.Thiruselvi	Dr.AMBIKA K
12.	27.7.23	Dr.AMBIKA K	Dr. T.Thiruselvi
13.	28.7.23	Dr. T.Thiruselvi	Dr.AMBIKA K
14.	03.08.23	Dr.AMBIKA K	Dr. T.Thiruselvi
15.	04.08.23	Dr. T.Thiruselvi	Dr.AMBIKA K
16.	05.08.23	Dr.AMBIKA K	Dr. T.Thiruselvi
17.	06.08.23	Dr. T.Thiruselvi	Dr.AMBIKA K
18.	07.08.23	Dr.AMBIKA K	Dr. T.Thiruselvi
19.	10.08.23	Dr. T.Thiruselvi	Dr.AMBIKA K
20.	11.08.23	Dr.AMBIKA K	Dr. T.Thiruselvi
21.	12.08.23	Dr. T.Thiruselvi	Dr.AMBIKA K

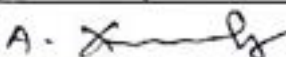
A. XAVIER FERNANDES, B.Sc. (Microbiology),
Assistant Professor,
Department of Microbiology
School of Arts & Science
Prist Deemed to be University, Thanjavur.

Dr. T. Thiruselvi
School of Arts & Science
Ponnaiyah Ramajayam Institute of
Science & Technology (PRIST)
Deemed to be University
Vallam, Thanjavur - 613 403.

22.	13.08.23	Dr.AMBIKA K	Dr. T.Thiruselvi
23.	14.08.23	Dr. T.Thiruselvi	Dr.AMBIKA K
24.	17.08.23	Dr.AMBIKA K	Dr. T.Thiruselvi
25.	18.08.23	Dr. T.Thiruselvi	Dr.AMBIKA K
26.	19.08.23	Dr.AMBIKA K	Dr. T.Thiruselvi
27.	20.08.23	Dr. T.Thiruselvi	Dr.AMBIKA K
28.	21.08.23	Dr. T.Thiruselvi	
29.	24.08.23	Dr.AMBIKA K	
30.	25.08.23	Dr. T.Thiruselvi	

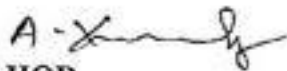

HOD

A. KAVIER FERNANDES, M Sc, M Ed, M Phil, Ph.D.,
 Assistant Professor
 Department of Microbiology
 School of Arts & Science
 Prist Deemed to be University, Thanjavur.



DEAN

DEAN

School of Arts & Science
 Annalyah Ramajayam Institute
 Science & Technology (PRIST)
 Deemed to be University
 Vallam, Thanjavur - 613 403



PONNAIYAH RAMAJAYAM INSTITUTE OF
SCIENCE & TECHNOLOGY (PRIST)

Declared as DEEMED TO BE UNIVERSITY
Uls 3 of UGC Act, 1956

School of Arts and Science
Department of Microbiology
Certificate Course on Clinical Laboratory Technology
Students Enrolled List
Academic Year 2023-2024

S.No	Reg.No	Name of the students
1.	2101MB10118	P.Sundar
2.	2101MB10119	R.Kalai
3.	2101MB10120	Suman.S
4.	2101MB10121	Sathishkumar.S
5.	2101MB10122	Balakumar
6.	2101MB10123	Kamaraj.D
7.	2101MB10124	Akilash.R
8.	2101MB10125	Rakesh.N
9.	2101MB10126	Guna.R
10.	2101MB10127	Selva Kumar.S
11.	2101MB10128	Raja.A
12.	2101MB10129	P.Selvakumar
13.	2101MB10130	Jehan.S
14.	2101MB10131	Arunkumar.P
15.	2101MB10132	Arjun.J

HOD

A.XAVIER FERNANDES, M.Sc., M.Phil., Ph.D.,

Assistant Professor

Department of Microbiology

School of Arts & Science

Prst Deemed to be University, Thanjavur.

DEAN

DEAN

School of Arts & Science
Ponnaiyah Ramajayam Institute of
Science & Technology (PRIST)

Deemed to be University
Vallam, Thanjavur - 613 403.



School of Arts and Science
Department of Microbiology
Certificate Course on Clinical Laboratory Technology
Students Attendance - Academic Year 2023-2024

S.No	Reg.No	Name of the Student	12.23	13.23	14.23	15.23	16.23	17.23	18.23	19.23	20.23	21.23	22.23	23.23	24.23	25.23	26.23	27.23	28.23	03.08.23	04.08.23	05.08.23	06.08.23	07.08.23	10.08.23	11.08.23	12.08.23	13.08.23	14.08.23	17.08.23	18.08.23	19.08.23	20.08.23	21.08.23	24.08.23	25.08.23																	
1	2101MB10118	P.Sundar	P	P	P	P	P	P	P	P	P	P	P	P	P	P	P	P	P	P	P	P	P	P	P	P	P	P	P	P	P	P	P	P	P	P	P	P	P	P	P	P											
2	2101MB10119	R.Kalai	P	P	P	P	P	P	P	P	P	P	P	P	P	P	P	P	P	P	P	P	P	P	P	P	P	P	P	P	P	P	P	P	P	P	P	P	P	P	P	P	P	P	P								
3	2101MB10120	Suman.S	P	P	P	P	P	P	P	P	P	P	P	P	P	P	P	P	P	P	P	P	P	P	P	P	P	P	P	P	P	P	P	P	P	P	P	P	P	P	P	P	P	P	P	P	P						
4	2101MB10121	Sathishkumar.S	P	P	P	P	P	P	P	P	P	P	P	P	P	P	P	P	P	P	P	P	P	P	P	P	P	P	P	P	P	P	P	P	P	P	P	P	P	P	P	P	P	P	P	P	P	P					
5	2101MB10122	Dalakumar	A	P	P	P	P	P	P	P	P	P	P	P	P	P	P	P	P	P	P	P	P	P	P	P	P	P	P	P	P	P	P	P	P	P	P	P	P	P	P	P	P	P	P	P	P	P					
6	2101MB10123	Kannaraj.D	P	P	P	P	P	P	P	P	P	P	P	P	P	P	P	P	P	P	P	P	P	P	P	P	P	P	P	P	P	P	P	P	P	P	P	P	P	P	P	P	P	P	P	P	P	P	P				
7	2101MB10124	Akilash.R	P	P	P	P	P	P	P	P	P	P	P	P	P	P	P	P	P	P	P	P	P	P	P	P	P	P	P	P	P	P	P	P	P	P	P	P	P	P	P	P	P	P	P	P	P	P	P	P			
8	2101MB10125	Rakesh.N	P	P	P	P	P	P	P	P	P	P	P	P	P	P	P	P	P	P	P	P	P	P	P	P	P	P	P	P	P	P	P	P	P	P	P	P	P	P	P	P	P	P	P	P	P	P	P	P			
9	2101MB10126	Gunar.R	P	P	P	P	P	P	P	P	P	P	P	P	P	P	P	P	P	P	P	P	P	P	P	P	P	P	P	P	P	P	P	P	P	P	P	P	P	P	P	P	P	P	P	P	P	P	P	P			
10	2101MB10127	Selva Kumar.S	A	P	P	P	P	P	P	P	P	P	P	P	P	P	P	P	P	P	P	P	P	P	P	P	P	P	P	P	P	P	P	P	P	P	P	P	P	P	P	P	P	P	P	P	P	P	P	P	P		
11	2101MB10128	Raja.A	P	P	P	P	P	P	P	P	P	P	P	P	P	P	P	P	P	P	P	P	P	P	P	P	P	P	P	P	P	P	P	P	P	P	P	P	P	P	P	P	P	P	P	P	P	P	P	P	P		
12	2101MB10129	P.Selvakumar	P	P	P	P	P	P	P	P	P	P	P	P	P	P	P	P	P	P	P	P	P	P	P	P	P	P	P	P	P	P	P	P	P	P	P	P	P	P	P	P	P	P	P	P	P	P	P	P	P	P	P
13	2101MB10130	Jehan.S	P	P	P	P	P	P	P	P	P	P	P	P	P	P	P	P	P	P	P	P	P	P	P	P	P	P	P	P	P	P	P	P	P	P	P	P	P	P	P	P	P	P	P	P	P	P	P	P	P	P	P
14	2101MB10131	Anunkumar.P	P	P	P	P	P	P	P	P	P	P	P	P	P	P	P	P	P	P	P	P	P	P	P	P	P	P	P	P	P	P	P	P	P	P	P	P	P	P	P	P	P	P	P	P	P	P	P	P	P	P	P
15	2101MB10132	Arun.J	P	P	P	P	P	P	P	P	P	P	P	P	P	P	P	P	P	P	P	P	P	P	P	P	P	P	P	P	P	P	P	P	P	P	P	P	P	P	P	P	P	P	P	P	P	P	P	P	P	P	P

Dr. A. JAVIER FERNADES, M.Sc. Ph.D., M.Phil. M.D.,
Assistant Professor

Department of Microbiology
School of Arts & Science
PRIST Deemed to be University, Thanjavur.

PRIST
School of Arts & Science
Ponnaiyah Ramajayam Institute of
Science & Technology (PRIST)
Deemed to be University
Vallam Thattai Road - 613 403



**PONNAIYAH RAMAJAYAM INSTITUTE OF
SCIENCE & TECHNOLOGY (PRIST)**

Declared as DIEMER TO BE UNIVERSITY
Slg 3 of UGC Act, 1956

**School of Arts and Science
Department of Microbiology**

**Diploma in Seaweed Culture
Academic Year 2023-2024
ODD semester**

S.No	Date	I hour 2.30-3.30 pm	2 hour 3.30-4.30 pm
1.	12.7.23	Dr.K.Karuppaiya	Dr. T.Thiruselvi
2.	13.7.23	Dr. T.Thiruselvi	Dr.K.Karuppaiya
3.	14.7.23	Dr.K.Karuppaiya	Dr. T.Thiruselvi
4.	15.7.23	Dr. T.Thiruselvi	Dr.K.Karuppaiya
5.	16.7.23	Dr.K.Karuppaiya	Dr. T.Thiruselvi
6.	19.7.23	Dr. T.Thiruselvi	Dr.K.Karuppaiya
7.	20.7.23	Dr.K.Karuppaiya	Dr. T.Thiruselvi
8.	21.7.23	Dr. T.Thiruselvi	Dr.K.Karuppaiya
9.	22.7.23	Dr.K.Karuppaiya	Dr. T.Thiruselvi
10.	23.7.23	Dr. T.Thiruselvi	Dr.K.Karuppaiya
11.	26.7.23	Dr.K.Karuppaiya	Dr. T.Thiruselvi
12.	27.7.23	Dr. T.Thiruselvi	Dr.K.Karuppaiya
13.	28.7.23	Dr.K.Karuppaiya	Dr. T.Thiruselvi
14.	03.08.23	Dr. T.Thiruselvi	Dr.K.Karuppaiya
15.	04.08.23	Dr.K.Karuppaiya	Dr. T.Thiruselvi
16.	05.08.23	Dr. T.Thiruselvi	Dr.K.Karuppaiya
17.	06.08.23	Dr.K.Karuppaiya	Dr. T.Thiruselvi
18.	07.08.23	Dr. T.Thiruselvi	Dr.K.Karuppaiya
19.	10.08.23	Dr.K.Karuppaiya	Dr. T.Thiruselvi
20.	11.08.23	Dr. T.Thiruselvi	Dr.K.Karuppaiya
21.	12.08.23	Dr.K.Karuppaiya	Dr. T.Thiruselvi

22.	13.08.23	Dr. T.Thiruselvi	Dr.K.Karuppaiya
23.	14.08.23	Dr.K.Karuppaiya	Dr. T.Thiruselvi
24.	17.08.23	Dr. T.Thiruselvi	Dr.K.Karuppaiya
25.	18.08.23	Dr.K.Karuppaiya	Dr. T.Thiruselvi
26.	19.08.23	Dr. T.Thiruselvi	Dr.K.Karuppaiya
27.	20.08.23	Dr.K.Karuppaiya	Dr. T.Thiruselvi
28.	21.08.23	Dr. T.Thiruselvi	Dr.K.Karuppaiya
29.	24.08.23	Dr.K.Karuppaiya	Dr. T.Thiruselvi
30.	25.08.23	Dr. T.Thiruselvi	Dr.K.Karuppaiya
31.	26.08.23	Dr.K.Karuppaiya	Dr. T.Thiruselvi
32.	27.08.23	Dr. T.Thiruselvi	Dr.K.Karuppaiya
33.	28.08.23	Dr.K.Karuppaiya	Dr. T.Thiruselvi
34.	29.08.23	Dr. T.Thiruselvi	Dr.K.Karuppaiya
35.	1.9.23	Dr.K.Karuppaiya	Dr. T.Thiruselvi
36.	2.9.23	Dr. T.Thiruselvi	Dr.K.Karuppaiya
37.	3.9.23	Dr.K.Karuppaiya	Dr. T.Thiruselvi
38.	4.9.23	Dr. T.Thiruselvi	Dr.K.Karuppaiya
39.	7.9.23	Dr.K.Karuppaiya	Dr. T.Thiruselvi
40.	8.9.23	Dr. T.Thiruselvi	Dr.K.Karuppaiya
41.	9.9.23	Dr.K.Karuppaiya	Dr. T.Thiruselvi
42.	10.9.23	Dr. T.Thiruselvi	Dr.K.Karuppaiya
43.	11.9.23	Dr.K.Karuppaiya	Dr. T.Thiruselvi
44.	14.9.23	Dr. T.Thiruselvi	Dr.K.Karuppaiya
45.	15.9.23	Dr.K.Karuppaiya	Dr. T.Thiruselvi

HOD

A. KAVIER FERNANDES, M.Sc. Ph.D.,
Assistant Professor,
Department of Microbiology
School of Arts & Science
Pris Deemed to be University, Thanjavur.



DEAN
DEAN
School of Arts & Science
onnaiyah Ramajayam Institute
Science & Technology (PRIS)
Deemed to be University
Valliam, Thanjavur - 613 403



PONNAIYAH RAMAJAYAM INSTITUTE OF
SCIENCE & TECHNOLOGY (PRIST)

Declared as DEEMED TO BE UNIVERSITY
Uix 3 of USC Act, 1956

School of Arts and Science
Department of Microbiology
Diploma in Seaweed Culture
Students Enrolled List
Academic Year 2023-2024

S.No	Reg.No	Name of the students
1.	2201MB10101	Arjun.J
2.	2201MB10102	Vengateshwaran.S
3.	2201MB10103	Jaya Velu
4.	2201MB10104	K.Kumaran
5.	2201MB10105	K.Madhan
6.	2201MB10106	B.Balakumar
7.	2201MB10107	C.Charan
8.	2201MB10108	Y.Nagamani
9.	2201MB10109	K.Nadimuthu
10.	2201MB10110	G.Vetri
11.	2201MB10111	M.Seva
12.	2201MB10112	M.Vetri Vetri
13.	2201MB10113	Arun Kumar .A
14.	2201MB10202	Jayasri.E
15.	2201MB10203	Aarthi.R
16.	2201MB10204	Sathya Prabha.S
17.	2201MB10205	Jaisri.R
18.	2201MB10206	Vedatmika.M
19.	2201MB10207	K.Veena
20.	2201MB10208	K.Kavi Chandra

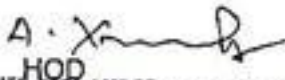
A. Xavier Fernandes

HOD
Assistant Professor
Department of Microbiology
School of Arts & Science



DEAN
DEAN
School of Arts & Science
Ponnaiyah Ramajayam Institute of
Science & Technology (PRIST)
Deemed to be University
Vallam, Thanjavur - 615 001



School of Arts and Science
Department of Microbiology
Diploma in Seaweed Culture
Students Attendance - Academic Year 2023-2024

S.NO	REG.NO	Name Of The Student	12.7.23	13.7.23	14.7.23	15.7.23	16.7.23	19.7.23	20.7.23	21.7.23	22.7.23	23.7.23	26.7.23	27.7.23	28.7.23	03.08.23	04.08.23	05.08.23	06.08.23	07.08.23	10.08.23	11.08.23	12.08.23	13.08.23	14.08.23	17.08.23
1.	2201MB10101	Ajuna J	P	P	P	P	P	P	P	P	P	P	P	P	P	P	P	P	P	P	P	P	P	P	P	P
2.	2201MB10102	Venguleswaran,S	P	P	P	P	P	P	P	P	P	P	P	P	P	P	P	P	P	P	P	P	P	P	P	P
3.	2201MB10103	Jaya Velu	P	P	P	P	P	P	P	P	P	P	P	P	P	P	P	P	P	P	P	P	P	P	P	P
4.	2201MB10104	K.Kumar	P	P	P	P	P	P	P	P	P	P	P	P	P	P	P	P	P	P	P	P	P	P	P	P
5.	2201MB10105	K.Madhan	A	P	P	P	P	P	P	P	P	P	P	A	P	P	P	P	P	P	P	P	P	P	A	P
6.	2201MB10106	B.Balakumar	P	P	P	P	P	P	P	P	P	P	P	P	P	P	P	P	P	P	P	P	P	P	P	P
7.	2201MB10107	C.Charan	P	P	P	P	A	P	P	A	P	P	P	P	P	P	P	A	P	P	A	P	P	P	P	P
8.	2201MB10108	Y.Nagamani	P	P	P	P	P	P	P	P	P	P	P	P	P	P	P	P	P	P	P	P	P	P	P	P
9.	2201MB10109	K.Nadimathu	P	P	P	P	P	P	P	P	P	P	P	P	P	P	P	P	P	P	P	P	P	P	P	P
10.	2201MB10110	G.Veeri	A	P	P	P	P	P	P	P	P	P	P	A	P	P	P	P	P	P	P	P	P	P	A	P
11.	2201MB10111	M.Seva	P	P	P	P	P	P	A	P	P	P	P	P	P	P	P	P	P	P	A	P	P	P	P	P
12.	2201MB10112	M.Veeri Veeri	P	P	P	P	P	P	P	P	P	P	P	P	P	P	P	P	P	P	P	P	P	P	P	P
13.	2201MB10113	Arun Kumar ,A	P	P	P	P	P	P	P	P	P	P	P	P	P	P	P	P	P	P	P	P	P	P	P	P
14.	2201MB10202	Jayanti E	P	P	P	P	P	P	P	P	P	P	P	P	P	P	P	P	P	A	P	P	P	P	P	P
15.	2201MB10203	Aarthi,R	P	P	P	P	P	P	P	P	P	P	P	P	P	P	P	P	P	P	P	P	P	P	P	P
16.	2201MB10204	Saitya Prabha,S	P	P	P	P	P	P	P	P	P	A	P	P	A	P	P	A	P	P	P	P	P	P	P	P
17.	2201MB10205	Jasri R	P	P	P	P	P	P	P	P	P	P	P	P	P	P	P	P	P	P	P	P	P	P	P	P
18.	2201MB10206	Vedamika,M	P	P	A	P	P	P	A	P	P	P	P	P	P	P	P	P	P	P	P	P	P	P	P	P
19.	2201MB10207	K.Veema	P	P	P	P	P	P	P	P	P	P	P	P	P	P	P	P	P	P	P	P	P	P	P	P
20.	2201MB10208	K.Kavi Chandra	P	P	P	P	P	P	P	P	P	P	P	P	P	P	P	P	P	P	P	P	P	P	P	P

A. ANIL
Dr. ANIL FERIANDES, M.Sc., Ph.D.,
Assistant Professor

Department of Microbiology
School of Arts & Science

School of Arts & Science
Ponnaiyah Ramajayam Institute of
Science & Technology (PRIST)
Deemed to be University
Vallam Thiruvananthapuram - 613 403



School of Arts and Science
Department of Microbiology
Diploma in Seaweed Culture

Students Attendance - Academic Year 2023-2024

S.NO	REG.NO	Name Of The Student	Attendance																					
			18.08.23	19.08.23	20.08.23	21.08.23	24.08.23	25.08.23	26.08.23	27.08.23	28.08.23	29.08.23	01.09.23	02.09.23	02.09.23	03.09.23	04.09.23	07.09.23	08.09.23	09.09.23	10.09.23	11.09.23	14.09.23	15.09.23
1.	2201MB10101	Arjun.J	P	P	P	P	P	P	P	P	P	P	P	P	P	P	P	P	P	P	P	P	P	P
2.	2201MB10102	Vengateshwaran.S	P	P	P	P	P	P	P	P	P	P	P	P	P	P	P	P	P	P	P	P	P	P
3.	2201MB10103	Jaya Velu	P	P	P	A	P	P	P	P	P	P	P	P	P	P	P	P	A	P	P	P	P	P
4.	2201MB10104	K.Kumaran	P	P	P	P	P	P	P	P	P	P	P	P	P	P	P	P	P	P	P	P	P	P
5.	2201MB10105	K.Madhan	P	P	P	P	P	P	P	P	P	P	P	P	P	P	P	P	P	P	P	P	P	P
6.	2201MB10106	B.Balakumar	P	P	P	P	P	P	P	P	P	P	P	P	P	P	P	P	P	P	P	P	P	P
7.	2201MB10107	C.Charan	P	P	P	P	P	P	A	P	P	P	P	P	P	P	P	P	P	P	P	P	P	P
8.	2201MB10108	Y.Nagamani	P	P	P	P	P	P	P	P	P	P	P	P	P	P	P	P	P	P	P	P	P	P
9.	2201MB10109	K.Nadimuthu	P	P	P	P	P	P	P	P	P	P	P	P	P	P	P	P	P	P	P	P	P	P
10.	2201MB10110	G.Veeri	P	P	P	P	P	P	P	P	P	P	P	P	P	P	P	P	P	P	P	P	P	P
11.	2201MB10111	M.Seva	P	P	P	P	P	P	P	P	P	P	P	P	P	P	P	P	P	P	P	P	P	P
12.	2201MB10112	M.Veeri Veeri	P	P	P	P	P	P	P	P	P	P	P	P	P	P	P	P	A	P	P	P	P	P
13.	2201MB10113	Arun Kumar .A	P	P	P	P	P	P	P	P	P	P	P	P	P	P	P	P	P	P	P	P	P	P
14.	2201MB10202	Jayasri.E	P	P	P	P	P	P	P	P	P	P	P	P	P	P	P	P	P	P	P	P	P	P
15.	2201MB10203	Aarthi.R	P	P	P	P	P	P	P	P	P	P	P	P	P	P	P	P	P	P	P	P	P	P
16.	2201MB10204	Sathya Prabha.S	P	P	P	P	P	P	P	P	P	P	P	P	P	P	P	P	P	P	P	P	P	P
17.	2201MB10205	Jaisri.R	P	P	P	P	P	P	P	P	P	P	P	P	P	P	P	P	P	P	P	P	P	P
18.	2201MB10206	Vedantika.M	P	P	P	P	P	P	P	P	P	P	P	P	P	P	P	P	P	P	P	P	P	P
19.	2201MB10207	K.Veena	P	P	P	P	P	P	P	P	P	P	P	P	P	P	P	P	P	P	P	P	P	P
20.	2201MB10208	K.Kavi Chandra	P	P	P	P	P	P	P	P	P	P	P	P	P	P	P	P	P	P	P	P	P	P

Dr.A.SANJEEV FERNANDES, M.Sc, M.Phil, M.Ed, M.A.,
Assistant Professor

Department of Microbiology
School of Arts & Science

Prist Deemed to be University, Th...

DEAN

School of Arts & Science
Ponnaiyah Ramajayam Institute of
Science & Technology (PRIST),
Deemed to be University

Vallam Thiruvaiyar - 613 405



**PONNAIYAH RAMAJAYAM INSTITUTE OF
SCIENCE & TECHNOLOGY (PRIST)**

Declared as DEEMED TO BE UNIVERSITY
Sl. 3 of UGC Act, 1956

**School of Arts and Science
Department of Microbiology**

**Certificate Course in Advances in Plant Tissue Culture
Academic Year 2023-2024
Even Semester**

S.No	Date	1 hour 2.30-3.30 pm	2 hour 3.30-4.30 pm
1.	1.2.24	Dr. A.Xavier Fernandes	Dr. T.Thiruselvi
2.	2.2.24	Dr.R.Sathya	Dr. A.Xavier Fernandes
3.	5.2.24	Dr. T.Thiruselvi	Dr.R.Sathya
4.	6.2.24	Dr. A.Xavier Fernandes	Dr. T.Thiruselvi
5.	7.2.24	Dr.R.Sathya	Dr. A.Xavier Fernandes
6.	8.2.24	Dr. T.Thiruselvi	Dr.R.Sathya
7.	9.2.24	Dr. A.Xavier Fernandes	Dr. T.Thiruselvi
8.	12.2.24	Dr.R.Sathya	Dr. A.Xavier Fernandes
9.	13.2.24	Dr. T.Thiruselvi	Dr.R.Sathya
10.	14.2.24	Dr. A.Xavier Fernandes	Dr. T.Thiruselvi
11.	15.2.24	Dr.R.Sathya	Dr. A.Xavier Fernandes
12.	16.2.24	Dr. T.Thiruselvi	Dr.R.Sathya
13.	19.2.24	Dr. A.Xavier Fernandes	Dr. T.Thiruselvi
14.	20.2.24	Dr.R.Sathya	Dr. A.Xavier Fernandes
15.	21.2.24	Dr. T.Thiruselvi	Dr.R.Sathya
16.	22.2.24	Dr. A.Xavier Fernandes	Dr. T.Thiruselvi
17.	23.2.24	Dr.R.Sathya	Dr. A.Xavier Fernandes
18.	26.2.24	Dr. T.Thiruselvi	Dr.R.Sathya
19.	27.2.24	Dr. A.Xavier Fernandes	Dr. T.Thiruselvi
20.	28.2.24	Dr.R.Sathya	Dr. A.Xavier Fernandes
21.	29.2.24	Dr. T.Thiruselvi	Dr.R.Sathya

22.	1.3.24	Dr. A.Xavier Fernandes	Dr. T.Thiruselvi
23.	2.3.24	Dr.R.Sathya	Dr. A.Xavier Fernandes
24.	3.3.24	Dr. T.Thiruselvi	Dr.R.Sathya
25.	6.3.24	Dr. A.Xavier Fernandes	Dr. T.Thiruselvi
26.	7.3.24	Dr.R.Sathya	Dr. A.Xavier Fernandes
27.	8.3.24	Dr. T.Thiruselvi	Dr.R.Sathya
28.	9.3.24	Dr. A.Xavier Fernandes	
29.	10.3.24	Dr.R.Sathya	
30.	13.3.24	Dr. T.Thiruselvi	

A.X. Fernandes

HOD

Dr.A.XAVIER FERNANDES, M.Sc. B.Sc. M.Phil. Ph.D.,
Assistant Professor
Department of Microbiology
School of Arts & Science
Prist Deemed to be University, Thanjavur.

[Signature]

DEAN

DEAN
School of Arts & Science
Ponnalyah Ramajayam Institute of
Science & Technology (PRIST)
Deemed to be University
Thanjavur - 613 007



PONNAIYAH RAMAJAYAM INSTITUTE OF
SCIENCE & TECHNOLOGY (PRIST)

Declared as DEEMED TO BE UNIVERSITY
U/s 3 of UGC Act, 1956

School of Arts and Science
Department of Microbiology
Certificate Course in Advances in Plant Tissue Culture

Students Enrolled List
Academic Year 2023-2024

S.No	Reg.No	Name of the students
1.	2201MB10218	B.FATHIMA
2.	2201MB10219	K.KANIJA
3.	2201MB10220	L.LIYANA
4.	2201MB10221	E.RAJESWARI
5.	2201MB10222	S.SANA
6.	2201MB10223	R.REYANA
7.	2201MB10224	T.REENA
8.	2201MB10225	H.LAKSHMI
9.	2201MB10226	G.GAYATHIRI
10.	2201MB10227	M.SUSMITHA
11.	2201MB10228	M.JEEVA
12.	2201MB10229	B. Aameera
13.	2201MB10230	M.KANIKA
14.	2201MB10231	K.SIVANI SRI
15.	2201MB10232	K.LAKSHMI SRI

HOD
A. XAVIER FERNADES, M.Sc. & M.Phil. M.D.,
Assistant Professor
Department of Microbiology
School of Arts & Science

DEAN
DEAN
School of Arts & Science
Ponnaiyah Ramajayam Institute of
Science & Technology (PRIST)
Deemed to be University
Vallam, Thanjavur - 613 402.



**School of Arts and Science
Department of Microbiology
Certificate Course in Advances in Plant Tissue Culture
Students Attendance - Academic Year 2023-2024**

S. No	Reg.No	Name of the Student	01.02.24	02.02.24	03.02.24	04.02.24	05.02.24	06.02.24	07.02.24	08.02.24	09.02.24	12.02.24	13.02.24	14.02.24	15.02.24	16.02.24	19.02.24	20.02.24	21.02.24	22.02.24	23.02.24	26.02.24	27.02.24	28.02.24	29.02.24	01.03.24	02.03.24	03.03.24	06.03.24	07.03.24	08.03.24	09.03.24	10.03.24	13.03.24				
1	2201MB10218	B.Fathima	P	P	P	P	P	P	P	P	P	P	P	P	P	P	P	P	P	P	P	P	P	A	P	P	P	P	P	P	P	P	P	P	P	P		
2	2201MB10219	K.Kanija	P	P	P	P	P	P	P	P	P	P	P	P	P	P	P	P	P	P	P	P	P	P	P	P	P	P	P	P	P	P	P	P	P	P	P	
3	2201MB10220	L.Liyana	P	P	P	P	P	P	P	P	P	P	P	P	P	P	P	P	P	P	P	P	P	P	P	P	P	P	P	P	P	P	P	P	P	P	P	
4	2201MB10221	E.Rajeswari	P	P	P	P	P	P	P	P	P	P	P	P	P	P	P	P	P	P	P	P	P	P	P	P	P	P	P	P	P	P	P	P	P	P	P	
5	2201MB10222	S.Sana	P	P	P	P	P	P	P	P	P	P	P	P	P	P	P	P	P	P	P	P	P	P	P	P	P	P	P	P	P	P	P	P	P	P	P	
6	2201MB10223	R.Reyana	P	P	P	P	P	P	P	P	P	P	P	P	P	P	P	P	P	P	P	P	P	P	P	P	P	P	P	P	P	P	P	P	P	P	P	
7	2201MB10224	T.Reena	P	P	P	P	P	P	P	P	P	P	P	P	P	P	P	P	P	P	P	P	P	P	P	P	P	P	P	P	P	P	P	P	P	P	P	
8	2201MB10225	H.Lakshmi	P	P	P	P	P	P	P	P	P	P	P	P	P	P	P	P	P	P	P	P	P	P	P	P	P	P	P	P	P	P	P	P	P	P	P	P
9	2201MB10226	G.Gayathiri	P	P	P	P	P	P	P	P	P	P	P	P	P	P	P	P	P	P	P	P	P	P	P	P	P	P	P	P	P	P	P	P	P	P	P	P
10	2201MB10227	M.Susmitha	P	P	P	P	P	P	P	P	P	P	P	P	P	P	P	P	P	P	P	P	P	P	P	P	P	P	P	P	P	P	P	P	P	P	P	P
11	2201MB10228	M.Jeeva	P	P	P	P	P	P	P	P	P	P	P	P	P	P	P	P	P	P	P	P	P	P	P	P	P	P	P	P	P	P	P	P	P	P	P	P
12	2201MB10229	B. Ameera	P	P	P	P	P	P	P	P	P	P	P	P	P	P	P	P	P	P	P	P	P	P	P	P	P	P	P	P	P	P	P	P	P	P	P	P
13	2201MB10230	M.Kanika	P	P	P	P	P	P	P	P	P	P	P	P	P	P	P	P	P	P	P	P	P	P	P	P	P	P	P	P	P	P	P	P	P	P	P	P
14	2201MB10231	K.Sivani Sri	P	P	P	P	P	P	P	P	P	P	P	P	P	P	P	P	P	P	P	P	P	P	P	P	P	P	P	P	P	P	P	P	P	P	P	P
15	2201MB10232	K.Lakshmi Sri	P	P	P	P	P	P	P	P	P	P	P	P	P	P	P	P	P	P	P	P	P	P	P	P	P	P	P	P	P	P	P	P	P	P	P	P

A. Xavier

Dr.A.XAVIER FERNANDES, M.Sc., M.Ed., Ph.D.,
 Assistant Professor
 Department of Microbiology
 School of Arts & Science
 Prist Deemed to be University, Thanjavur.

DEAN
 School of Arts & Science
 Ponnaiyah Ramajayam Institute of
 Science & Technology (PRIST)
 Deemed to be University
 Vallam, Thanjavur - 613 403.



PONNAIYAH RAMAJAYAM INSTITUTE OF
SCIENCE & TECHNOLOGY (PRIST)

Declared as DEEMED-TO-BE UNIVERSITY
Uis 3 of UGC Act, 1956

SCHOOL OF ARTS AND SCIENCE
DEPARTMENT OF MICROBIOLOGY
VALUE ADDED COURSE

Certificate of Appreciation

This is to certify that Ms/ Mr MUGILAN. G
Reg No 2101MB10109 has completed the value added course on
Biofertilizer Production Technology from 12.07.2023 to 25.08.2023
during the Academic year of 2023-2024

A. Xavier
HOD

Assistant Professor
Department of Microbiology
School of Arts & Science
Prist Deemed to be University, Thanjavur.

[Signature]

DEAN
DEAN

School of Arts & Science
Ponnaiyah Ramajayam Institute of
Science & Technology (PRIST)
Deemed to be University
Vallam, Thanjavur - 613 403.



PONNAIYAH RAMAJAYAM INSTITUTE OF
SCIENCE & TECHNOLOGY (PRIST)

Declared as DEEMED-TO-BE-UNIVERSITY
Uis 3 of UGC Act, 1956

SCHOOL OF ARTS AND SCIENCE
DEPARTMENT OF MICROBIOLOGY
VALUE ADDED COURSE

Certificate of Appreciation

*This is to certify that Ms/ Mr A.AFISHA RAMEEZA
Reg No 2101MB10201 has completed the value added course on
Biofertilizer Production Technology from 12.07.2023 to 25.08.2023
during the Academic year of 2023-2024*

A. Xanthi
HOD

[Signature]
DEAN

Assistant Professor,
Department of Microbiology
School of Arts & Science
Prist Deemed to be University, Thanjavur.

School of Arts & Science
Ponnaiyah Ramajayam Institute of
Science & Technology (PRIST)
Deemed to be University
Vallam, Thanjavur - 613 403.



PONNAIYAH RAMAJAYAM INSTITUTE OF SCIENCE & TECHNOLOGY (PRIST)

Declared as DEEMED TO BE UNIVERSITY
Uis 3 of UGC Act, 1956

**SCHOOL OF ARTS AND SCIENCE
DEPARTMENT OF MICROBIOLOGY
VALUE ADDED COURSE**

Certificate of Appreciation

*This is to certify that Ms/ Mr PRAVEENKUMAR.N
Reg No 2101MB10101 has completed the value added course on
Biofertilizer Production Technology from 12.07.2023 to 25.08.2023
during the Academic year of 2023-2024*

A. X. ...
HOD

DEAN

DEAN

School of Arts & Science
Ponnaiyah Ramajayam Institute of
Science & Technology (PRIST)
Deemed to be University
K. J. Somaiya Road, Thanjavur - 613 407

Department of Microbiology
School of Arts & Science
PRIST Deemed to be University, Thanjavur.



PONNAIYAH RAMAJAYAM INSTITUTE OF
SCIENCE & TECHNOLOGY (PRIST)

Deemed to be University
Uis 3 of UGC Act. 1956

SCHOOL OF ARTS AND SCIENCE
DEPARTMENT OF MICROBIOLOGY
VALUE ADDED COURSE

Certificate of Appreciation

This is to certify that Ms/ Mr K.RAJKUMAR
Reg No 2101MB10102 has completed the value added course on
Biofertilizer Production Technology from 12.07.2023 to 25.08.2023
during the Academic year of 2023-2024

A. X...
HOD

Assistant Professor
Department of Microbiology
School of Arts & Science
Prst Deemed to be University, Thanjavur.

DEAN

DEAN
School of Arts & Science
Ponnaiyah Ramajayam Institute of
Science & Technology (PRIST)
Deemed to be University
Vallam, Thanjavur - 613 403.

POMMAIYAH RAMAJAYAM INSTITUTE OF
SCIENCE & TECHNOLOGY (PRIST)

DECLARED AS DEEMED TO BE UNIVERSITY
U/S 3 of UGC ACT, 1956



SCHOOL OF ARTS AND SCIENCE
DEPARTMENT OF MICROBIOLOGY
VALUE ADDED COURSE

Certificate of Appreciation

This is to certify that Ms/ Mr R.RAGHUL
Reg No 2101MB10103 has completed the value added course on
Biofertilizer Production Technology from 12.07.2023 to 25.08.2023
during the Academic year of 2023-2024

A. X. &
HOD

[Signature]

DEAN

DEAN

School of Arts & Science
Ponnaiah Ramajayam Institute of
Science & Technology (PRIST)
Deemed to be University
Vallam, Thanjavur - 613 403.

Assistant Professor,
Department of Microbiology
School of Arts & Science
Prist Deemed to be University, Thanjavur.



PONNAIYAH RAMAJAYAM INSTITUTE OF
SCIENCE & TECHNOLOGY (PRIST)

Declared as DEEMED-TO-BE-UNIVERSITY
U/s 3 of UGC Act, 1956

SCHOOL OF ARTS AND SCIENCE
DEPARTMENT OF MICROBIOLOGY
VALUE ADDED COURSE

Certificate of Appreciation

This is to certify that Ms/ Mr C.Sneha
Reg No 2101MB10207 has completed the value added course on Food
Processing from 12.07.2023 to 25.08.2023 during the Academic year of
2023-2024

A. X. ...
HOD

Department of microbiology
School of Arts & Science
Prst Deemed to be University, Thanjavur.

[Signature]

DEAN

DEAN

Department of Arts & Sciences

Department of Microbiology (PRIST)
Ponnaiyah Ramajayam Institute of Science & Technology
Thanjavur, Tamil Nadu - 613 005.



PONNAIYAH RAMAJAYAM INSTITUTE OF
SCIENCE & TECHNOLOGY (PRIST)

Declared as DEEMED TO BE UNIVERSITY
Uis 3 of UGC Act, 1956

SCHOOL OF ARTS AND SCIENCE
DEPARTMENT OF MICROBIOLOGY
VALUE ADDED COURSE

Certificate of Appreciation

This is to certify that Ms/ Mr K.Sivapriya
Reg No 2101MB10208 has completed the value added course on Food
Processing from 12.07.2023 to 25.08.2023 during the Academic year of
2023-2024

Alexandra
HOD

ALEXANDRA FERRELL
Assistant Professor
Department of Microbiology
School of Arts & Science
PRIST Deemed to be University, Thanjavur.

[Signature]
DEAN

DEAN

School of Arts & Science
Ponnaiyah Ramajayam Institute of
Science & Technology (PRIST)
Deemed to be University,
Vallam, Thanjavur - 613 403.



**PONNAIYAH RAMAJAYAM INSTITUTE OF
SCIENCE & TECHNOLOGY (PRIST)**

Declared as DEEMED TO BE UNIVERSITY
Uis 3 of UGC Act, 1956

**SCHOOL OF ARTS AND SCIENCE
DEPARTMENT OF MICROBIOLOGY
VALUE ADDED COURSE**

Certificate of Appreciation

*This is to certify that Ms/ Mr K.Kavi Chandran
Reg No 2101MB10111 has completed the value added course on Food
Processing from 12.07.2023 to 25.08.2023 during the Academic year of
2023-2024*

A. Xanthi
HOD

SRM INTER TECHNOLOGICAL UNIVERSITY
DEPARTMENT OF MICROBIOLOGY
SCHOOL OF ARTS & SCIENCE
PRIST DEEMED TO BE UNIVERSITY, THANJAVUR.

[Signature]
DEAN

SCHOOL OF ARTS & SCIENCE
SRM INTER TECHNOLOGICAL UNIVERSITY
DEEMED TO BE UNIVERSITY
VELURU, THANJAVUR - 613 403.



PONNAIYAH RAMAJAYAM INSTITUTE OF
SCIENCE & TECHNOLOGY (PRIST)

Declared as DEEMED TO BE UNIVERSITY
Uis 3 of UGC Act, 1956

SCHOOL OF ARTS AND SCIENCE
DEPARTMENT OF MICROBIOLOGY
VALUE ADDED COURSE

Certificate of Appreciation

*This is to certify that Ms/ Mr B.Subhahini
Reg No 2101MB10202 has completed the value added course on Food
Processing from 12.07.2023 to 25.08.2023 during the Academic year of
2023-2024*

A. Xavier
HOD
Dr. A. Xavier FERTILISER, M.Sc., M.Tech., Ph.D., F.R.S.C.
Assistant Professor,
Department of Microbiology
School of Arts & Science
Prst Deemed to be University, Thanjavur.

[Signature]
DEAN

School of Arts,
Ponnaiyah Ramajayam Institute of
Science & Technology (Prst)
Deemed to be University,
Vallam, Thanjavur - 613 402.



PONNAIYAH RAMAJAYAM INSTITUTE OF
SCIENCE & TECHNOLOGY (PRIST)

DECLARED AS DEEMED-TO-BE UNIVERSITY
Uis 3 of UGC Act, 1956

SCHOOL OF ARTS AND SCIENCE
DEPARTMENT OF MICROBIOLOGY
VALUE ADDED COURSE

Certificate of Appreciation

*This is to certify that Ms/ Mr S.Parameshwaran
Reg No 2101MB10112 has completed the value added course on Food
Processing from 12.07.2023 to 25.08.2023 during the Academic year of
2023-2024*

A. Xavier
HOD

DR. JAVIER PEREIRA, M.Sc., M.Phil., Ph.D.
Department of Microbiology,
PRIST

School of Arts & Science
Prist Deemed to be University, Thanjavur.

DEAN

School of Arts & Science
Ponnaiyah Ramajayam
Institute of Science & Technology
Deemed to be University
Vallam, Thanjavur - 613 013.



**PONNAIYAH RAMAJAYAM INSTITUTE OF
SCIENCE & TECHNOLOGY (PRIST)**

Declared as DEEMED TO BE UNIVERSITY
U/s 3 of UGC Act, 1956

**SCHOOL OF ARTS AND SCIENCE
DEPARTMENT OF MICROBIOLOGY
VALUE ADDED COURSE**

Certificate of Appreciation

This is to certify that Ms/ Mr P.SUNDAR
Reg No 2101MB10118 has completed the value added course on Clinical
Laboratory Technology from 12.07.2023 to 25.08.2023 during the
Academic year of 2023-2024

[Signature]
HOD

DEAN

DEAN

School of Arts & Science
Ponnaiyah Ramajayam Institute of
Science & Technology (PRIST)
Deemed to be University
U/s 3 of UGC Act, 1956
Valluvar m. Thanjavur - 613 403

Department of Microbiology
School of Arts & Science
PRIST Deemed to be University, Thanjavur.



PONNAIYAH RAMAJAYAM INSTITUTE OF
SCIENCE & TECHNOLOGY (PRIST)

Declared as Deemed to be University
US 3 of UGC Act, 1956

SCHOOL OF ARTS AND SCIENCE
DEPARTMENT OF MICROBIOLOGY
VALUE ADDED COURSE

Certificate of Appreciation

This is to certify that Ms/ Mr R.KALAI
Reg No 2101MB10119 has completed the value added course on Clinical
Laboratory Technology from 12.07.2023 to 25.08.2023 during the
Academic year of 2023-2024

A. Xanthi
HOD



DEAN

DEAN

School of Arts & Science
Ponnaiyah Ramajayam Institute of
Science & Technology (PRIST)
Deemed to be University
Vallam, Thanjavur - 613 403.

Assistant Professor,
Department of Microbiology
School of Arts & Science
PRIST Deemed to be University, Thanjavur.

**PONNAIYAH RAMAJAYAM INSTITUTE OF
SCIENCE & TECHNOLOGY (PRIST)**

Declared as DEEMED TO BE UNIVERSITY
Uis 3 of UGC Act, 1956



**SCHOOL OF ARTS AND SCIENCE
DEPARTMENT OF MICROBIOLOGY
VALUE ADDED COURSE**

Certificate of Appreciation

This is to certify that Ms/ Mr SUMAN.S
Reg No 2101MB10120 has completed the value added course on *Clinical
Laboratory Technology* from 12.07.2023 to 25.08.2023 during the
Academic year of 2023-2024

A. Xxxxxx
HOD

[Signature]

DEAN

DEAN

School of Arts & Science
Ponnaiyah Ramajayam Institute of
Science & Technology (PRIST)
Deemed to be University
Vellur, Thanjavur - 613 403.

Assistant Professor,
Department of Microbiology
School of Arts & Science
PRIST Deemed to be University, Thanjavur.

PONNAIYAH RAMAJAYAM INSTITUTE OF
SCIENCE & TECHNOLOGY (PRIST)

Declared as DEEMED TO BE UNIVERSITY
Uis 3 of UGC Act, 1956



SCHOOL OF ARTS AND SCIENCE
DEPARTMENT OF MICROBIOLOGY
VALUE ADDED COURSE

Certificate of Appreciation

This is to certify that Ms/ Mr SATHISHKUMAR.S
Reg No 2101MB10121 has completed the value added course on *Clinical*
Laboratory Technology from 12.07.2023 to 25.08.2023 during the
Academic year of 2023-2024

A. S. S. S.
HOD

Dr. JAMIER FERNANDES, M.Sc., M.Phil., Ph.D.,
Assistant Professor,
Department of Microbiology
School of Arts & Science
Prist Deemed to be University, Thanjavur.

[Signature]
DEAN

DEAN
School of Arts & Science
Ponnaiyah Ramajayam Institute of
Science & Technology (PRIST)
Deemed to be University
M. Thanjavur - 615 433.



**PONNAIYAH RAMAJAYAM INSTITUTE OF
SCIENCE & TECHNOLOGY (PRIST)**

Declared as DEEMED TO BE UNIVERSITY
Uis 3 of UGC Act, 1956

**SCHOOL OF ARTS AND SCIENCE
DEPARTMENT OF MICROBIOLOGY
VALUE ADDED COURSE**

Certificate of Appreciation

*This is to certify that Ms/ Mr Balakumar
Reg No 2101MB10122 has completed the value added course on Clinical
Laboratory Technology from 12.07.2023 to 25.08.2023 during the
Academic year of 2023-2024*

A. Xavier
HOD

DRA. JAVIER FERNANDES, M.Sc. M.Phil. Ph.D.
Assistant Professor
Department of Microbiology
School of Arts & Science
PRIST Deemed to be University, Thanjavur.

Devi Singh

DEAN

DEAN

School of Arts & Science
Ponnaiyah Ramajayam Institute of
Science & Technology (PRIST)
Deemed to be University
Valluvar Street, Thanjavur - 613 403.



PONNAIYAH RAMAJAYAM INSTITUTE OF
SCIENCE & TECHNOLOGY (PRIST)

Declared as DEEMED TO BE UNIVERSITY
Uis 3 of UGC Act. 1956

**SCHOOL OF ARTS AND SCIENCE
DEPARTMENT OF MICROBIOLOGY
VALUE ADDED COURSE**

Certificate of Appreciation

*This is to certify that Ms/ Mr Arjun.J
Reg No 2201MB10101 has completed the value added course on seaweed
Culture from 12.07.2023 to 25.08.2023 during the Academic year of
2023-2024*

A. X. ...
HOD

Assistant Professor
Department of Microbiology
School of Arts & Science
Prist Deemed to be University, Thanjavur.

Arjun.J

DEAN

School of Arts & Science
Ponnaiyah Ramajayam Institute of
Science & Technology (PRIST)
Deemed to be University
Vallam, Thanjavur - 613 403.



**PONNAIYAH RAMAJAYAM INSTITUTE OF
SCIENCE & TECHNOLOGY (PRIST)**

Declared as DEEMED TO BE UNIVERSITY
U/S 3 of UGC Act, 1956

**SCHOOL OF ARTS AND SCIENCE
DEPARTMENT OF MICROBIOLOGY
VALUE ADDED COURSE**

Certificate of Appreciation

*This is to certify that Ms/ Mr Vengateshwaran.S
Reg No 2201MB10102 has completed the value added course on seaweed
Culture from 12.07.2023 to 25.08.2023 during the Academic year of
2023-2024*

A. X. ...
HOD

DEAN

School of Arts and Science

Department of Microbiology
School of Arts & Science
Ponnaiyah Ramajayam Institute of Science & Technology (PRIST)
Deemed to be University
Vallem, Thanjavur - 613 403.

Department of Microbiology
School of Arts and Science
Ponnaiyah Ramajayam Institute of Science & Technology (PRIST)
Deemed to be University
Vallem, Thanjavur - 613 403.



PONNAIYAH RAMAJAYAM INSTITUTE OF
SCIENCE & TECHNOLOGY (PRIST)

DECLARED AS DEEMED-TO-BE UNIVERSITY
U/s 3 of UGC Act, 1956

SCHOOL OF ARTS AND SCIENCE
DEPARTMENT OF MICROBIOLOGY
VALUE ADDED COURSE

Certificate of Appreciation

This is to certify that Ms/ Mr Jaya Velu
Reg No 2201MB10103 has completed the value added course on seaweed
Culture from 12.07.2023 to 25.08.2023 during the Academic year of
2023-2024

A. X. S.
HOD

Head of the Department
Department of Microbiology

School of Arts & Science
Prst Deemed to be University, Thanjavur.

DEAN

School of Arts & Science
Ponnaiyah Ramajayam Institute of
Science & Technology (PRIST)

Deemed to be University
Valluam, Thanjavur - 613 403.

PONNAIYAH RAMAJAYAM INSTITUTE OF
SCIENCE & TECHNOLOGY (PRIST)

DECLARED AS DEEMED TO BE UNIVERSITY
U/S 3 of UGC Act, 1956



SCHOOL OF ARTS AND SCIENCE
DEPARTMENT OF MICROBIOLOGY
VALUE ADDED COURSE

Certificate of Appreciation

This is to certify that Ms/ Mr K.Kumaran
Reg No 2201MB10104 has completed the value added course on seaweed
Culture from 12.07.2023 to 25.08.2023 during the Academic year of
2023-2024

A. K. ...
HOD

Assistant Professor
Department of Microbiology
School of Arts & Science
Prist Deemed to be University, Thanjavur.

[Handwritten Signature]

DEAN DEAN
School of Arts & Science
Ponnaiyah Ramajayam Institute of
Science & Technology (PRIST)
Valluvar, Thanjavur - 613 403.



PONNAIYAH RAMAJAYAM INSTITUTE OF
SCIENCE & TECHNOLOGY (PRIST)

Declared as DEEMED TO BE UNIVERSITY
Uis 3 of UGC Act. 1956

SCHOOL OF ARTS AND SCIENCE
DEPARTMENT OF MICROBIOLOGY
VALUE ADDED COURSE

Certificate of Appreciation

This is to certify that Ms/ Mr K.Madhan
Reg No 2201MB10105 has completed the value added course on seaweed
Culture from 12.07.2023 to 25.08.2023 during the Academic year of
2023-2024

A. K. S. S. S.
HOD

DEANN

School of Arts & Science
Ponnaiyah Ramajayam Institute of
Science & Technology
Deemed to be University
Vallam, Thanjavur - 613 403.

Department of Microbiology
School of Arts & Science
PRIST Deemed to be University, Thanjavur.



PONNAIYAH RAMAJAYAM INSTITUTE OF
SCIENCE & TECHNOLOGY (PRIST)

Declarated as Deemed-to-be University
Uis 3 of UGC Act, 1956

SCHOOL OF ARTS AND SCIENCE
DEPARTMENT OF MICROBIOLOGY
VALUE ADDED COURSE

Certificate of Appreciation

This is to certify that Ms/ Mr M.SUSMITHA
Reg No 2201MB10227 has completed the value added course on Plant
Tissue Culture from 12.07.2023 to 25.08.2023 during the Academic year
of 2023-2024

A. Jeyanthi
HOD

A. Jeyanthi
Assistant Professor
Department of Microbiology
School of Arts & Science
PRIST Deemed to be University, Thanjavur.

[Signature]

DEAN DEAN
School of Arts & Science
Ponnaiyah Ramajayam Institute of
Science & Technology (PRIST)
Deemed to be University
Valiam, Thanjavur - 613 403



PONNAIYAH RAMAJAYAM INSTITUTE OF
SCIENCE & TECHNOLOGY (PRIST)

DECLARED AS DEEMED TO BE UNIVERSITY
U/S 3 of UGC Act, 1956

**SCHOOL OF ARTS AND SCIENCE
DEPARTMENT OF MICROBIOLOGY
VALUE ADDED COURSE**

Certificate of Appreciation

This is to certify that Ms/ Mr M.JEEVA
Reg No 2201MB10228 has completed the value added course on Plant
Tissue Culture from 12.07.2023 to 25.08.2023 during the Academic year
of 2023-2024

A X
HOD

Signature

DEAN

School of Arts & Sciences
Ponnaiyah Ramajayam Institute
of Science & Technology (PRIST)

Deemed to be University
Valliam, Thanjavur - 613 403.

M. A. KAVIER FERNADES, B.Sc. M.Sc. M.Phil. M.Ed.
Assistant Professor
Department of Microbiology
School of Arts & Science
Prist Deemed to be University, Thanjavur.



PONNAIYAH RAMAJAYAM INSTITUTE OF SCIENCE & TECHNOLOGY (PRIST)

Declared as DEEMED TO BE UNIVERSITY
U/s 3 of UGC Act, 1956

SCHOOL OF ARTS AND SCIENCE
DEPARTMENT OF MICROBIOLOGY
VALUE ADDED COURSE

Certificate of Appreciation

This is to certify that Ms/ Mr B. AMEERA
Reg No 2201MB10229 has completed the value added course on Plant
Tissue Culture from 12.07.2023 to 25.08.2023 during the Academic year
of 2023-2024

A. Xavier
HOD

DEAN
School of Arts & Science
Ponnaiyah Ramajayam Institute of Science & Technology (PRIST)
Deemed to be University,
Vallam, Thanjavur - 613 408.

A. AMIER FERNANDES, B.Sc. M.Phil. M.Sc.
Assistant Professor
Department of Microbiology
School of Arts & Science
Prist Deemed to be University, Thanjavur.



PONNAIYAH RAMAJAYAM INSTITUTE OF
SCIENCE & TECHNOLOGY (PRIST)

Declarated as DEEMED TO BE UNIVERSITY
Uis 3 of UGC Act, 1956

SCHOOL OF ARTS AND SCIENCE
DEPARTMENT OF MICROBIOLOGY
VALUE ADDED COURSE

Certificate of Appreciation

This is to certify that Ms/ Mr M.KANIKA
Reg No 2201MB10230 has completed the value added course on Plant
Tissue Culture from 12.07.2023 to 25.08.2023 during the Academic year
of 2023-2024

A. K. S. S.
HOD

A. K. S. S.
Assistant Professor,
Department of Microbiology
School of Arts & Science
PRIST Deemed to be University, Thanjavur.

[Handwritten Signature]

DEAN
School of Arts & Science
PRIST Deemed to be University, Thanjavur.

PRIST Deemed to be University (P.U.)
Vellam, Thanjavur - 613 402



PONNAIYAH RAMAJAYAM INSTITUTE OF
SCIENCE & TECHNOLOGY (PRIST)

Declared as DEEMED TO BE UNIVERSITY
Uis 3 of UGC Act, 1956

SCHOOL OF ARTS AND SCIENCE
DEPARTMENT OF MICROBIOLOGY
VALUE ADDED COURSE

Certificate of Appreciation

This is to certify that Ms/ Mr K.SIVANI SRI
Reg No 2201MB10231 has completed the value added course on Plant
Tissue Culture from 12.07.2023 to 25.08.2023 during the Academic year
of 2023-2024

ARTS
HOD

Dr. A. XAVIER FERNANDES, B.Sc., M.Sc., M.Phil., Ph.D.
Assistant Professor
Department of Microbiology
School of Arts & Science
PRIST Deemed to be University, Thanjavur.

DEAN
School of Arts & Science
Ponnaiyah Ramajayam Insti-
tute of Science & Technology (PRIST)
Deemed to be University
Vallam, Thanjavur - 613 403.

APPLICATION FORM

1. Full Name
2. Programme
3. Discipline
4. Institution Name
5. Date of Birth
6. Sex (M/F)
7. E. mail
8. Mobile No.
9. Permanent Address

Signature of the Applicant

Submission of Application Form

Submit your Application form in person to the co-ordinator, School of Arts and Science, PRIST University, Thanjavur, Vallam, 613 403.

Application may be send to

Course Co-Ordinator
DR.D.CHINNARAJA
 Assistant Professor

Department of Chemistry
 PRIST University
 Email: chemistryprist@gmail.com

About the University

Pornayab Ramnayan Institute of Science and Technology (PRIST) is a The institute offers undergraduate and postgraduate courses in Engineering, Science, Education, Management, Arts, and Law, as well as research programmes.

Facilities Available

The University is housed in an independent, multi storing building with state of art equipment, excellent Laboratories and infrastructure to help complete this course. Majority of scientists have been acting as monitoring the research program. Computer Library with internet facilities for students, Hostel facilities, Health centre, Sports complex, etc..

Department of Chemistry

The Department has young as well as experienced and dynamic persons as faculty, is involved in providing quality education at Undergraduate (UG) and Postgraduate (PG) level. The staff are from various disciplines in Doctorate like Fuzzy theory, Graph theory, Topology, Stochastic Process, Number theory. Many of the staff members are encouraged to pursue their higher research works.



PRIST
 DEEMED TO BE
 UNIVERSITY
 NAAC ACCREDITED
 THANJAVUR - 613 403 - TAMIL NADU

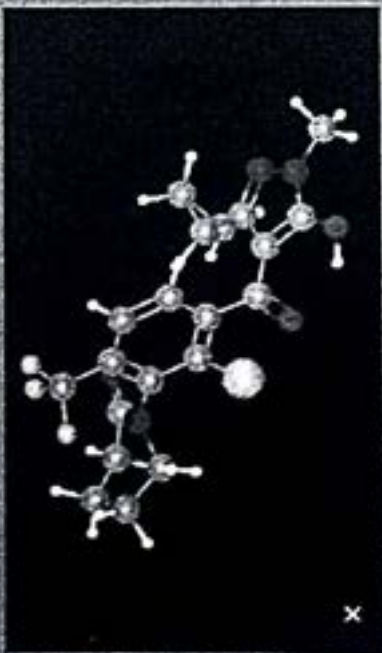

Certificate Course on Molecular
 Structure Drawing Tool
 2023 -2024

PRIST Deemed to be University
 Thanjavur, Vallam-613 403

School of Arts & Science
 Pornayab Ramnayan Institute
 Solikuppam, Thanjavur, PRIST

Head of the Department
 Department of Chemistry
 PRIST Deemed to be University
 Vallam, Thanjavur - 613403



PONNAIYAH RAMAJAYAM INSTITUTE OF
SCIENCE & TECHNOLOGY (PRIST)

Declared as DEEMED TO BE UNIVERSITY
Uix.3 of DGE Act, 1956

SCHOOL OF ARTS AND SCIENCE
DEPARTMENT OF CHEMISTRY

CIRCULAR

This is to inform all BSc Chemistry students that, the classes for the value-added program for the academic year 2023-2024 semester-VI will commence on 02.02.2024. The registered students are requested to attend the classes without fail.

Branch name	Year	Course offered
Bsc -Chemistry	BSc	Certificate Course on Molecular Structure Drawing Tool

VALUE ADDED COURSE

Academic year: 2023 -2024 PERIOD: 02.02.24 TO 14.03.24

Diploma Course on Molecular Structure Drawing Tool

Aim:

- To introduce students to molecular structure and biological evaluation of novel biologically active compounds.

Objectives:

- To inculcate concepts of molecular structure target identification and validation.
- To understand techniques in Phenotypic screening and target convolution.
- To increase employability of the students.
- To educate about role of molecular structure of novel biologically active compounds

Course Outcomes:

At the end of this unit, you will be able to:

- Understand the software used in chemistry
- Perform the Manipulations of Selected Objects
- Apply the chemdraw software to draw the different systems

Head of the Department
Department of Chemistry
PRIST Deemed to be University
Vallam, Thanjavur - 613403

DEAN
School of Arts & Science
Ponnaiyah Ramajayam Institute of
Science & Technology (PRIST)
Deemed to be University
Vallam, Thanjavur - 613403



PONNAIYAH RAMAJAYAM INSTITUTE OF
SCIENCE & TECHNOLOGY (PRIST)

Declared as DEEMED TO BE UNIVERSITY
On 3rd DEC. 1959

SCHOOL OF ARTS AND SCIENCE
DEPARTMENT OF CHEMISTRY

- Generate the IUPAC and physical properties of organic compounds
- Predict resonance spectral data of chemical structures.

UNIT-I: Molecular Structure Drawing Tool

ChemDraw - Introduction, Installation, Drawing molecular structures - structuretypes, drawing the framework of a structure, Drawing Bonds of Different Types Changing Bond Types, Introducing Atom Labels,

UNIT-II: Manipulations with Selected Objects

Manipulations with Selected Objects- Select Objects, Move Objects, Copy Objects, Rotate and Mirror Objects, Stretch/Shrink/Scale Objects, Structure Perspective, Join Objects.

UNIT-III: ChemDraw-Practical I

Drawing of molecules - acyclic, cyclic, heterocyclic and bicyclic systems

Analysis of molecules - formula, exact mass and elemental analysis Graphical representation of reaction scheme

UNIT-IV: ChemDraw-Practical II

Chemical structures to IUPAC names

IUPAC naming to chemical structures

2D structures into 3D structures

Prediction of boiling point, melting point, critical temperature, critical pressure, critical volume and heat of formation.

UNIT-V: ChemDraw-Practical III

Prediction of ¹H NMR & ¹³C NMR of following compounds: Ethanol, Ethyl methyl ketone,

Cycloheptanone, Pyridine and α -naphthol

Text Books:

Dr. StefanBierz Short Manual to the Chemical DrawingProgram ChemDraw Universityof Zurich I-V

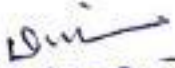
Head of the Department
Department of Chemistry
PRIST Deemed to be University
Vallam, Thanjavur - 613403

DEAN
School of Arts & Science
Ponnaiyah Ramajayam Institute of
Science & Technology (PRIST)
Deemed to be University
Vallam, Thanjavur - 613403

APPLICATION FORM

1. Full Name
2. Programme
3. Discipline
4. Institution Name
5. Date of Birth
6. Sex (M/F)
7. E. mail
8. Mobile No.
9. Permanent Address

Signature of the Applicant

Submission of Application Form

Submit your Application form in person to the co-ordinator, School of Arts and Science, PRIST University, Thanjavur, Vallam, 613 403.

Application may be send to

Course Co-Ordinator

DR.D.CHINNARAJA

Assistant Professor

Department of chemistry

PRIST University

E.mail: chemistryprist@gmail.com

About the University

Ponniyath Ramajayam Institute of Science and Technology (PRIST) is a deemed university in Vallam, India. The institute offers undergraduate and postgraduate courses in Engineering, Science, Education, Management, Arts, and Law, as well as research programmes.

Facilities Available

The University is housed in an independent, multi storing building with state of art equipment, excellent Laboratories and infrastructure to help complete this course. Majority of scientist have been acting as monitoring the research program. Computer Library with internet facilities for students, Hostel facilities, Health centre, Sports complex, etc..

Department of Chemistry

The Department has young as well as experienced and dynamic personalities as faculty, is involved in providing quality education at Undergraduate (UG) and Postgraduate (PG) levels. The staff are from various disciplines in Doctorate like Fuzzy theory, Graph theory, Topology, Stochastic Process, Number theory. Many of the staff members are encouraged to pursue their higher studies and research works. Head of the Department



PRIST
DEEMED TO BE
UNIVERSITY
NAAC ACCREDITED
THANAVUR - 613 403 - TAMIL NADU

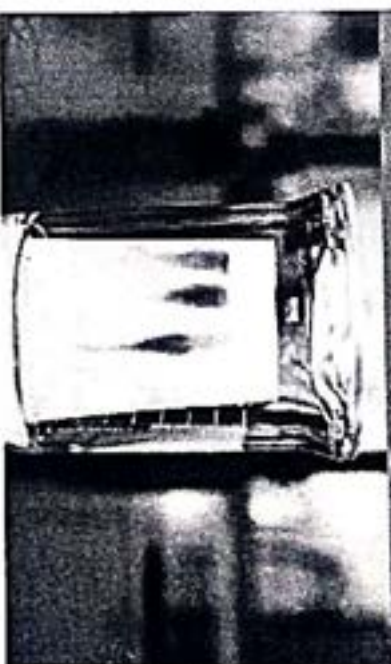

**Certificate course Crystallization
and Chromatography Techniques
2023-2024**

**PRIST Deemed to be University
Thanjavur, Vallam-613 403**

DEAN

School of Arts & Science
Ponniyath Ramajayam Institute of
Science & Technology (PRIST)
Deemed to be University
Vallam, Thanjavur - 613 403.

Department of Chemistry
PRIST Deemed to be University
Vallam, Thanjavur - 613 403

COURSE OBJECTIVE

- The most fundamental goal in drug design is to predict whether a given molecule will bind to a target and if so how strongly.
- These methods are also used to predict the conformation of the small molecule and to model conformational changes in the target that may occur when the small molecule binds to it.

COURSE CONTENT (Module 1)

Aims of Sustainable Development

COURSE CONTENT (Module 2)

Role and Function of Sustainable

Development

COURSE CONTENT (Module 3)

Sustainable Development

COURSE CONTENT (Module 4)

Sustainable Development

COURSE CONTENT (Module 5)

Sustainable Development

EXAMINATION

There shall be an university examination at the end of academic years.

Eligibility criteria for appearing in the in the final examination

Minimum Attendance - 80%

Minimum Internal Assessment marks - 40%

- It will be done through the whole year.
- Candidate must obtain at least 35% marks in theory

internal assessment to be eligible for the university examination.

Internal assessment (Theory) will be done as follows :

a) Mid-term and term examinations = 10 marks

b) Assignments/Projects/Class test/Clinical Presentations = 05 marks

c) Attendance = 05 marks

Total = 20 marks

Criteria for a pass in the subject

Minimum marks in theory - 45

Scheme of Examination:-

Duration of written examination - 3 hrs

Maximum marks - 100

Level of Knowledge Expected

Working knowledge with excellent technological value

Duration of the program

90 hrs add on diploma course

Course Program Outcome

- These methods are faster, and accurately provide valuable insights of experimental findings and mechanisms of action.
- In addition, appropriate implementation of these techniques could lead to a reduction in cost of drug designing and development.
- Currently in biomedicine sciences these software are exhibiting imperative role in the different phases of drug discovery.

Eligibility criteria

Any graduate shall be eligible for the admission to the course Intake Capacity 15 Seats on first cum first basis (Additional admission to the course is prerogative of the school)

Course Structure and Duration

Course is One year duration and will be of 90 hrs imparted training programme covering theoretical and practical aspects of Drug Design.

Certification

The candidates successfully qualifying the course the course shall be awarded a certificate to that effect in the appropriate form by School of Arts and Science, Department of chemistry, PRIST University, Thanjavur, Vallam

DEAN

Head of the Department
Department of Chemistry
Prismed to be University
Thanjavur - 613403

School of Arts & Sciences
Ponniyiah Ramaswami Institute of
Science & Technology (PRIST)
Prismed to be University
Vallam, Thanjavur - 613403



PONNAIYAH RAMAJAYAM INSTITUTE OF
SCIENCE & TECHNOLOGY (PRIST)

Declared as DEEMED TO BE UNIVERSITY
On 3 of DEC. Act. 1956

SCHOOL OF ARTS AND SCIENCE
DEPARTMENT OF CHEMISTRY

This is to inform all III BSc Chemistry students that, the classes for the value-added program for the academic year 2023-2024 semester-VI will be value-added on 02.02.24 To 14.03.24. The registered students are requested to attend the classes without fail

Branch name	Year	Course offered
Chemistry	III BSc	Certificate course Crystallization and Chromatography Techniques

VALUE ADDED COURSE
Academic year: 2023-2024

Course on Crystallization and chromatography techniques

Aim:

To introduce students to Crystallization and chromatography techniques.

Objectives:

- To inculcate concepts of thin layer and column identification and validation.
- To understand techniques in Phenotypic screening and target deconvolution.
- To increase the employability of the students.
- To educate about thin-layer column Chromatographic techniques of novel biologically active compounds.

Course Outcomes

- At the end of the course, students will be able to turn to understand methods of crystallization
- Explain the principles and techniques of column and thin-layer chromatography techniques.
- Purify the compounds by crystallization technique.
- Analyse and detect the sample thin-layer chromatography
- Separate the isomers of a compound by column chromatography technique

Unit – I Crystallization

Principle, Methods of recrystallization Melt crystallization, Suspension crystallization; solvents for recrystallization, Precipitation, Nucleation, Supersaturation, Common challenges in crystallization. Processes involved in crystallization, and applications.

Unit-II Chromatography Techniques

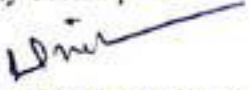
Head of the Department
Department of Chemistry
PRIST Deemed to be University
Vallam, Thanjavur - 613403

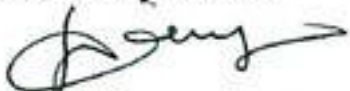
DEAN
School of Arts & Science
Ponnaiyah Ramajayam Institute of
Science & Technology (PRIST)
Deemed to be University
Vallam, Thanjavur - 613 403.



SCHOOL OF ARTS AND SCIENCE
DEPARTMENT OF CHEMISTRY

Chromatography – Adsorption, Partition chromatography. Column Chromatography - Principle, Adsorbents, developers, solvents, columns, packing of the columns, elution, eluting solvent selection- polar and non-polar; Applications.

Thin Layer chromatography – Principle, Rf, preparation of chromatophores application of sample on the chromatophores choice of adsorbents, selection of solvent, locating reagents, developing chamber, development of chromatogram and Applications.

Unit-III Practical

Crystallization of simple compounds Zinc oxide, Copper sulfate, Sodium acetate, Sodium Chloride, Potash alum, Phthalic acid, Benzoic acid, Acetyl salicylic acid, Urea and Sugar.

Unit – IV Practical

Thin Layer Chromatography Separation of Mixture of benzophenone and naphthalene Separation of Mixture of 2-nitrophenol and 4-nitrophenol Separation of Mixture of Diphenylamine, Benzophenone and Naphthalene Separation of Mixture of Azobenzene, Hydroxyazobenzene and p-aminoazobenzene

Unit – V Practical

Column Chromatography Separation of $KMnO_4$ and $K_2Cr_2O_7$ Isolation of 2-nitrophenol and 4-nitrophenol

Text Books:

- 1) R. Gopalan, P. S. Subramanian and K. Rengarajan, "Elements of Analytical Chemistry," Sultan Chand & Sons, New Delhi, 2003.
- 2) Ravindran, P. N., Babu, K. N., & Sivaraman, K. (2007). Turmeric: the genus *Curcuma*. CRC press.
- 3) Furniss, B. S. (Ed.). (2011). Vogel's textbook of practical organic chemistry. Pearson Education India.

Head of the Department
Department of Chemistry
PRIST Deemed to be University
Vallam, Thanjavur - 613403

DEAN
School of Arts & Science
Ponnaiyah Ramajayam Institute of
Science & Technology (PRIST)
Deemed to be University
Vallam, Thanjavur - 613403.

APPLICATION FORM

1. Full Name
2. Programme
3. Discipline
4. Institution Name
5. Date of Birth
6. Sex (M/F)
7. E-mail
8. Mobile No.
9. Permanent Address

Signature of the Applicant

Submission of Application Form

Submit your Application form in person to the co-ordinator, School of Arts and Science, PRIST University, Thanjavur, Vallam, 613 403.

Application may be send to
 Course Co-Ordinator
 Mr. B. Manikandan
 Assistant Professor
 Department of chemistry
 PRIST University
 E-mail: chemistryprist@gmail.com

About the University

Ponnaiyah Ramajayam Institute of Science and Technology (PRIST) is a deemed university in Vallam, India. The institute offers undergraduate and postgraduate courses in Engineering, Science, Education, Management, Arts, and Law, as well as research programmes.

Facilities Available

The University is housed in an independent, multi storied building with state of art equipment, excellent Laboratories and infrastructure to help complete this course. Majority of scientist have been acting as monitoring the research program. Computer Library with internet facilities for students, Hostel facilities, Health centre, Sports complex, etc.

Department of Chemistry

The Department has young as well as experienced and dynamic personalities as faculty, is involved in providing quality education at Undergraduate (UG) and Postgraduate (PG) levels. The staff are from various disciplines in Doctorate like Fuzzy theory, Graph theory, Topology, Stochastic Process, Number theory. Many of the staff members are encouraged to pursue their higher studies and research work.



PRIST
 DEEMED TO BE
 UNIVERSITY
 NAAC ACCREDITED
 THANJAVUR - 613 403 - TAMIL NADU

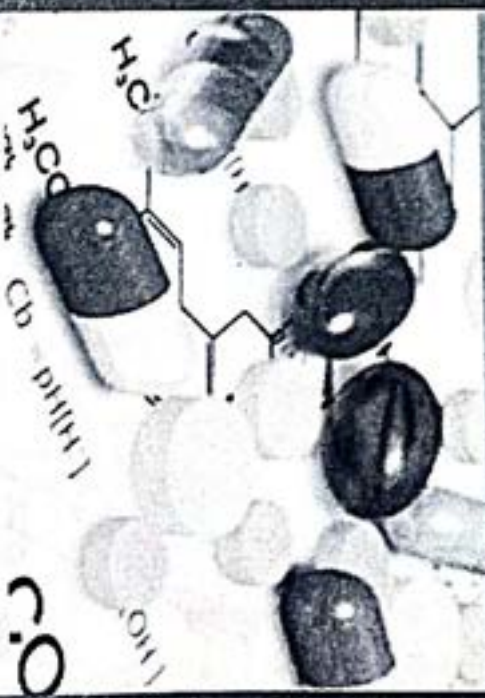

**Certificate course Drug Design
 DRUG DESIGN
 2023-2024**

**PRIST Deemed to be
 University Thanjavur, Vallam**

613 403

DEEMED TO BE UNIVERSITY
 Ponnaiyah Ramajayam Institute of Science & Technology (PRIST)
 Deemed to be University
 Vallam, Thanjavur - 613 403

COURSE OBJECTIVE

- The most fundamental goal in drug design is to predict whether a given molecule will bind to a target and if so how strongly.
- These methods are also used to predict the conformation of the small molecule and to model conformational changes in the target that may occur when the small molecule binds to it.

COURSE CONTENT (Module 1)

Aims of Food Science and Technology

COURSE CONTENT (Module 2)

Role and Function of water in Biological Systems

COURSE CONTENT (Module 3)

Food Conversion Operations

COURSE CONTENT (Module 4)

Food adulteration testing

COURSE CONTENT (Module 5)

Health problems of food adulteration

EXAMINATION

There shall be an university examination at the end of academic years.

Eligibility criteria for appearing in the in the final examination

- Minimum Attendance - 80%
- Minimum Internal Assessment marks - 40%
- It will be done through the whole year.
- Candidate must obtain at least 35% marks in theory
- internal assessment to be eligible for the university examination.

Internal assessment (Theory) will be done as follows :

- a) Mid-term and term examinations = 10 marks
- b) Assignments/Projects/Class test/Clinical Presentations = 05 marks
- c) Attendance = 05 marks

Total = 20 marks

Criteria for a pass in the subject
Minimum marks in theory - 45

Scheme of Examination:-

Duration of written examination - 3 hrs
Maximum marks - 100

Level of Knowledge Expected

Working knowledge with excellent technological value

Duration of the program

90 hrs add on diploma course

Course Program Outcome

- These methods are faster, and accurately provide valuable insights of experimental findings and mechanisms of action.
- In addition, appropriate implementation of these techniques could lead to a reduction in cost of drug designing and development.
- Currently in biomedicine sciences these software are exhibiting imperative role in the different phases of drug discovery.

Eligibility criteria

Any graduate shall be eligible for the admission to the course Intake Capacity 15 Seats on first cum first basis (Additional admission to the course is prerogative of the school)

Course Structure and Duration

Course is One year duration and will be of 90 hrs imparted training programme covering theoretical and practical aspects of Drug Design.

Certification

The candidates successfully qualifying the course the course shall be awarded a certificate to that effect in the appropriate form by School of Arts and Science, Department of chemistry, PRTS University, Haujivur, Vallam.

DEEN

School of Arts and Science

Ponnaiyah Ramalinga Pillai
School of Arts and Science
Department of Chemistry

Deemed to be University
Vallam, Thrissur



SCHOOL OF ARTS AND SCIENCE
DEPARTMENT OF CHEMISTRY

SCHOOL OF ARTS AND SCIENCE DEPARTMENT OF CHEMISTRY

CIRCULAR

This is to inform all I MSc Chemistry students that, the classes for the value program for the academic year 2023- 2024 semester-VI will commence 19.07.23. The registered students are requested to attend the classes without fail.

Branch name	Year	Course offered
CHEMISTRY -22415NH1	MSc	Certificate course Drug Design

Aim:

- To introduce students to Design, synthesis, and biological evaluation of novel biologically active compounds.

Objectives:

- To inculcate concepts of Drug target identification and validation.
- To understand techniques in Phenotypic screening and target deconvolution.
- To increase employability of the students.
- To improve the Biochemical analyses of drug targets and their pathways.
- To educate about role of Design, synthesis, and biological evaluation of novel biologically active compounds.

Course Outcomes:

At the end of this unit, you will be able to:

- Drug target identification and validation
- Describe Process of Design, synthesis, and biological evaluation.
- Fragment-based drug discovery
- Pharmaceutical/red biotechnology
- Isolation, structural characterization, (bio)synthesis, bioengineering and pharmacological evaluation of natural products

UNIT – I

Introduction to The Drug Discovery/Development - Drug Discovery - Drug Development - Source of Drugs - Structural effects on drug action

UNIT – II

Approaches to New Drug Discovery - Drugs Derived from Natural Products - Existing Drugs as a Source for New Drug Discovery - Screening for New Drug Leads - Modern "Rational Approach" to Drug Design - Approaches to Lead Optimization

UNIT – III

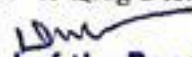
Head of the Department
Department of Chemistry
PRIST Deemed to be University
Vallam, Thanjavur - 613403

DEAN
School of Arts & Science
Ponnaiyah Ramajayam Institute of
Science & Technology (PRIST)
Deemed to be University
Vallam, Thanjavur - 613403



PONNAIYAH RAMAJAYAM INSTITUTE OF
SCIENCE & TECHNOLOGY (PRIST)

Declared as DEEMED TO BE UNIVERSITY
Via 3 of UGC Act, 1956

SCHOOL OF ARTS AND SCIENCE
DEPARTMENT OF CHEMISTRY

Enzymes as Targets of Drug Design - Enzyme kinetics – Enzyme inhibition and activation - Approaches to the Rational Design of Enzyme Inhibitors

UNIT – IV

Receptors as Targets of Drug Design - Receptor Theory – Receptor Complexes and Allosteric Modulators - Second and Third Messenger Systems - Molecular Biology of Receptors - Receptor Models and Nomenclature

UNIT – V

Prodrug Design and Applications - Definition - Applications – Prodrug Design Considerations - Prodrug Forms of Various Functional Groups - Drug release and activation mechanisms

References:

1. Kerns, E.H.; Di, L. Drug-Like Properties: Concepts, Structure Design and Methods: from ADME to Toxicity Optimization, Academic Press, Oxford, 2008
2. BMC – Burger's Medicinal Chemistry and Drug Discovery, 6th Edition, Vol. 1. Principles and Practice, edited by M. E. Wolff, John Wiley & Sons: New York, 2003. PMC – Principles of Medicinal Chemistry, 7th Edition, edited by T.L. Lemke, D. A. Williams, V. F. Roche, and S.W. Zito, Williams and Wilkins: Philadelphia, 2013.

Head of the Department
Department of Chemistry
PRIST Deemed to be University
Vallam, Thanjavur - 613401

DEAN
School of Arts & Science
Ponnaiyah Ramajayam Institute of
Science & Technology (PRIST)

APPLICATION FORM

1. Full Name
2. Programme
3. Discipline
4. Institution Name
5. Date of Birth
6. SEX (M/F)
7. E-mail
8. Mobile No
9. Permanent Address

Signature of the Applicant

Submission of Application Form

Submit your Application form in person to the coordinator, School of Arts and Science, PRIST University, Thanjavur, Vallam, 613 403

Application may be send to

Course Co-Ordinator
DR.D.CHINNABAJA
 Assistant Professor
 Department of chemistry
 PRIST University
 E-mail: chemistry.prist@gmail.com

About the University

Ponnayiah Ramayyan Institute of Science and Technology (PRIST) is a deemed university in Vallam, India. The institute offers undergraduate and postgraduate courses in Engineering, Science, Education, Management, Arts, and Law, as well as research programmes.

Facilities Available

The University is housed in an independent, multi-storied building with state of art equipment, excellent Laboratories and infrastructure to help complete this course. Majority of scientist have been acting as mentoring the research program. Computer Library with internet facilities for students, Hostel facilities, Health centre, Sports complex, etc...

Department of Chemistry

The Department has young as well as experienced and dynamic personalities as faculty, is involved in providing quality education at Undergraduate (UG) and Postgraduate (PG) levels. The staff are from various disciplines in Doctorate like Fuzzy theory, Graph theory, Topology, Stochastic Process, Number theory. Many of the staff members are encouraged to pursue their higher studies and research works.

Head of the Department
 Department of Chemistry
 PRIST Deemed to be University
 Vallam, Thanjavur - 613 403

[Signature]



PRIST
 DEEMED TO BE
UNIVERSITY
 NAAC ACCREDITED
 THANJAVUR - 613 403 - TAMIL NADU

Water - A Natural Resource



CERTIFICATE COURSE

Water Resource, Management and Water Pollution & Health

02.02.24 To - 14.03.24 / 2023-2024

DEAN

School of Arts & Science
 Ponnayiah Ramayyan Institute of
 Science & Technology (PRIST)
 Deemed to be University
 Vallam, Thanjavur - 613 403

COURSE OBJECTIVE

- The most fundamental goal in drug design is to predict whether a given molecule will bind to a target and if so how strongly.
- These methods are also used to predict the conformation of the small molecule and to model conformational changes in the target that may occur when the small molecule binds to it.

COURSE CONTENT (Module 1)

Aims of Sustainable Development

COURSE CONTENT (Module 2)

Role and Function of Sustainable

Development

COURSE CONTENT (Module 3)

Sustainable Development

COURSE CONTENT (Module 4)

Sustainable Development

COURSE CONTENT (Module 5)

Sustainable Development

EXAMINATION

There shall be an university examination at the end of academic years.

Eligibility criteria for appearing in the in the final examination

- Minimum Attendance - 80%
 - Minimum Internal Assessment marks - 40%
 - It will be done through the whole year.
 - Candidate must obtain at least 35% marks in theory.
- internal assessment to be eligible for the university examination.

Internal assessment (Theory) will be done as follows :

- Mid-term and term examinations = 10 marks
- Assignments/Projects/Class test/Clinical Presentations = 05 marks
- Attendance = 05 marks

Total = 20 marks

Criteria for a pass in the subject

Minimum marks in theory - 45

Scheme of Examinations:-

Duration of written examination - 3 hrs

Maximum marks - 100

Level of Knowledge Expected

Working knowledge with excellent technological value

Duration of the program

90 hrs add on diploma course

Course Program Outcome

- These methods are faster, and accurately provide valuable insights of experimental findings and mechanisms of action.
- In addition, appropriate implementation of these techniques could lead to a reduction in cost of drug designing and development.
- Currently in biomedicine sciences these software are exhibiting imperative role in the different phases of drug discovery.

Eligibility criteria

Any graduate shall be eligible for the admission to the course Intake Capacity 15 Seats on first cum first basis (Additional admission to the course is prerogative of the school)

Course Structure and Duration

Course is One year duration and will be of 90 hrs imparted training programme covering theoretical and practical aspects of Drug Design.

Certification

The candidates successfully qualifying the course the course shall be awarded a certificate to that effect in the appropriate form by School of Arts and Science, Department of chemistry, PRIST University, Thanjavur, Vallam.



Head of the Department
Department of Chemistry
PRIST Deemed to be University
Vallam, Thanjavur - 613403

Dean

School of Arts & Science
Ponnalyah Ramajayam Institute of
Science & Technology (PRIST)
Deemed to be University
Vallam, Thanjavur - 613403



PONNAIYAH RAMAJAYAM INSTITUTE OF
SCIENCE & TECHNOLOGY (PRIST)

Declared as DEEMED TO BE UNIVERSITY
U's 3 of SSC Act, 1956

SCHOOL OF ARTS AND SCIENCE
DEPARTMENT OF CHEMISTRY

CIRCULAR

This is to inform all I MSc Chemistry students that, the classes for the value program for the academic year 2023- 2024 semester-VI will commence **02.02.24 To – 14.03.24**
The registered students are requested to attend the classes without fail

Branch name	Year	Course offered
CHEMISTRY -22415NHI	MSc	Certificate course Water Resource, Management and Water Pollution & health

Branch name Year Course offered Health III BSc Certificate course Water
Resource, Management and Water Pollution & health
SCHOOL OF ARTS AND SCIENCE DEPARTMENT OF CHEMISTRY PERIOD: 02.02.24 To –
14.03.24 ADDED COURSE
Academic year: 2023-2024

Course on Water Resources, Management, and Water Pollution & Health

Aim: To provide an idea on Water Resources, Management, and Water Pollution & Health Course

learning outcomes:

- The participants will learn about the importance of water resources.
- The participants will get insight into the water cycle.
- They will learn and understand the water pollution problem and its gravity.

UNIT -1

Water cycle and water chemistry The water cycle, Properties of water. Tetrahedral chemistry of water. Physical Physico chemical characteristics water bodies.

UNIT -2

Water resources and treatment Types of water resources National drinking water policy. Drinking water treatment plants and various disinfection processes Household treatment, Drinking water standards.

UNIT -3

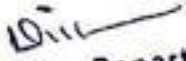
Head of the Department
Department of Chemistry
PRIST Deemed to be University
Vallam, Thanjavur - 613403

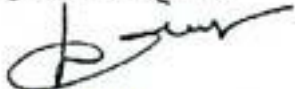
DEAN
School of Arts & Science
Ponnaiyah Ramajayam Institute of
Science & Technology (PRIST)
Deemed to be University
Vallam, Thanjavur



SCHOOL OF ARTS AND SCIENCE
DEPARTMENT OF CHEMISTRY

Water pollution Causes effect and control measures of water pollution. Pollution control standards, WHO standards of drinking water. Waterborne diseases. Microbial contamination of water types, sources, threats. Microbial standards of drinking water, MPN.

UNIT -4

Water conservation and water pollution acts in India. Water conservation: Ice stupa artificial glacier by Sonam Wangchuk.

UNIT -5

Rainwater harvesting. Watershed Management: Classification, Objective, Advantages and Disadvantages.

References

1) Water Q&A: Why is water the "universal solvent"? Water Science School. United States

Geological Survey, U.S. Department of the Interior. 20 June 2019. Archived from the original on 6 February 2021. Retrieved 15 January 2021.

2) 10.2: Hybrid Orbitals in Water. Chemistry LibreTexts. 18 March 2020. Archived from the original on 30 July 2022. Retrieved 11 April 2021.

3) Environmental Health Education Program. Cambridge, MA: Harvard T.H. Chan School of Public Health. July 23, 2013. Archived from the original on September 18, 2021. Retrieved September 18, 2021.

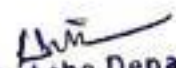
Head of the Department
Department of Chemistry
PRIST Deemed to be University
Vallam, Thanjavur - 613403

DEAN
School of Arts & Science
Ponnaiyah Ramajayam Institute
Science & Technology (PRIST)
Deemed to be University
Vallam, Thanjavur - 613403

APPLICATION FORM

1. Full Name
2. Programme
3. Discipline
4. Institution Name
5. Date of Birth
6. Sex (M/F)
7. E-mail
8. Mobile No.
9. Permanent Address

Signature of the Applicant

Submission of Application Form

Submit your Application form in person to the co-ordinator, School of Arts and Science, PRIST University, Thanjavur, Vallam, 613 403.

Application may be send to
Course Co-Ordinator

DR.D.CHINNARAJA
 Assistant Professor
 Department of Chemistry
 PRIST University
 E-mail: chemistryprist@gmail.com

About the University

Ponniyiah Ramalingam Institute of Science and Technology (PRIST) is a deemed university in Vallam, India. The institute offers undergraduate and postgraduate courses in Engineering, Science, Education, Management, Arts, and Law, as well as research programmes.

Facilities Available

The University is housed in an independent, multi storied building with state of it equipment, excellent Laboratories and infrastructure to help complete this course. Majority of scientist have been acting as monitoring the research program. Computer Library with internet facilities for students, Hostel facilities, Health centre, Sports complex, etc...

Department of Chemistry

The Department has young as well as experienced and dynamic personalities as faculty, is involved in providing quality education at Undergraduate (UG) and Postgraduate (PG) levels. The staff are from various disciplines in Doctorate like Fuzzy theory, Graph theory , Topology, Stochastic Process, Number theory. Many of the staff members are encouraged to pursue their independent research works.



PRIST
 DEEMED TO BE
 UNIVERSITY
 NAAC ACCREDITED
 THANJAVUR - 613 403 - TAMIL NADU

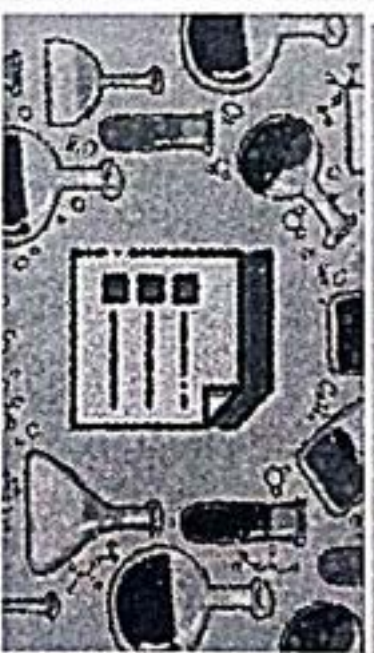

Certificate Course on UV-VISIBLE, IR SPECTROSCOPIC INSTRUMENTATION AND SEPARATIONTECHNIQUES
 2023-2024

PRIST Deemed to be University Thanjavur, Vallam-613 403

[Handwritten Signature]

DEAN
 School of Arts & Sciences
 Ponniyiah Ramalingam Institute of Science & Technology (PRIST)
 Deemed to be University
 Vallam, Thanjavur - 613 403

[Handwritten Signature]
 Head of the Department
 Department of Chemistry
 PRIST University
 Thanjavur - 613 403

COURSE OBJECTIVE

• The most fundamental goal in drug design is to predict whether a given molecule will bind to a target and if so how strongly.

• These methods are also used to predict the conformation of the small molecule and to model conformational changes in the target that may occur when the small molecule binds to it.

COURSE CONTENT (Module 1)

Aims of Sustainable Development

COURSE CONTENT (Module 2)

Role and Function of Sustainable Development

Development

COURSE CONTENT (Module 3)

Sustainable Development

COURSE CONTENT (Module 4)

Sustainable Development

COURSE CONTENT (Module 5)

Sustainable Development

EXAMINATION

There shall be an university examination at the end of academic years.

Eligibility criteria for appearing in the in the final examination

Minimum Attendance - 80%
Minimum Internal Assessment marks - 40%
• It will be done through the whole year.

• Candidate must obtain at least 35% marks in theory
internal assessment to be eligible for the university examination.

Internal assessment (Theory) will be done as follows :

- a) Mid-term and term examinations = 10 marks
- b) Assignments/Projects/Class test/Clinical Presentations = 05 marks
- c) Attendance = 05 marks

Total = 20 marks

Criteria for a pass in the subject
Minimum marks in theory - 45

Scheme of Examination:-
Duration of written examination - 3 hrs
Maximum marks - 100

Level of Knowledge Expected
Working knowledge with excellent technological value

Duration of the program
90 hrs add on diploma course

Course Program Outcome

- These methods are faster, and accurately provide valuable insights of experimental findings and mechanisms of action.
- In addition, appropriate implementation of these techniques could lead to a reduction in cost of drug designing and development.
- Currently in biomedicine sciences these software are exhibiting imperative role in the different phases of drug discovery.

Eligibility criteria

Any graduate shall be eligible for the admission to the course Intake Capacity 15 Seats on first cum first basis (Additional admission to the course is prerogative of the school)

Course Structure and Duration

Course is One year duration and will be of 90 hrs imparted training programme covering theoretical and practical aspects of Drug Design.

Certification

The candidates successfully qualifying the course the course shall be awarded a certificate to that effect in the appropriate form by School of Arts and Science, Department of chemistry, PRIEST University, Thanjavur, Vallam.

Head of the Department
Department of Chemistry
PRIEST Deemed to be University
Vallam, Thanjavur - 613 403

School of Arts & Science
Ponnaiyah Ramalingam Institute of
Science & Technology (PRIEST)
Deemed to be University
Thanjavur - 613 403



SCHOOL OF ARTS AND SCIENCE
DEPARTMENT OF CHEMISTRY

SCHOOL OF ARTS AND SCIENCE DEPARTMENT OF CHEMISTRY

CIRCULAR

This is to inform all MSc Chemistry students that, the classes for the value program for the academic year 2023- 2024 semester-VI will commence 09.07.23 to 30.08.23. The registered students are requested to attend the classes without fail.

Branch name	Year	Course offered
CHEMISTRY -22415NIII	MSc	Certificate Course on UV-VISIBLE, IR SPECTROSCOPIC INSTRUMENTATION AND SEPARATION TECHNIQUES

**Course on UV-VISIBLE, IR SPECTROSCOPIC INSTRUMENTATION AND
SEPARATION TECHNIQUES**

Aim: Purification of aniline by distillation.

Separation of organic liquid mixture by fractional distillation.

Removal of solvent from a reaction mixture by reduced pressure distillation.

Objectives:

- To inculcate concepts of molecular structure target identification and validation.
- To understand techniques in Phenotypic screening and target deconvolution.
- To increase employability of the students.
- To educate about role of molecular structure of novel biologically active compounds.

Course Outcomes:

At the end of the course students will be able to:

Explain the fundamental components of UV-Visible spectrophotometer.
Familiarize the instrumentation of IR spectroscopy.

Examine the given material by UV-Visible spectroscopy.

Investigate the nature of the functional groups present in the sample by IR spectroscopy. Separate the sample by distillation techniques.

UNIT-I: Instrumentation of UV-Visible Spectroscopy -

UV-Visible Spectroscopy-principle, nomenclature of the components of IR instrument - fundamental components- Schematic diagram of fundamental components, photometer, spectrophotometer, optical, spectrophotometer, colorimeter and spectrograph.

Head of the Department
Department of Chemistry
PRIST Deemed to be University
Vallam, Thanjavur - 613403

DEAN
School of Arts & Science
Ponnaiyah Ramajayam Institute
Science & Technology (PRIST)
Deemed to be University
Vallam, Thanjavur - 613403



SCHOOL OF ARTS AND SCIENCE
DEPARTMENT OF CHEMISTRY

UV-Visible Radiation source - essential characteristics, UV- light sources, visible light sources;

Dispersing devices, filters and monochromators: prism, gratings; slits, test sample and optical materials, radiation detector and indicator- barrier layer cell, photo emissive cell, photomultiplier cell.

UNIT-II: Instrumentation of IR Spectroscopy

IR Spectroscopy- principle, instrumentation-IR spectrometer-types-single beam and double beam spectrometer;

Source of IR radiation, IR mono chromator, detector- selective detector-photo conductive cell; non-selective detectors- thermocouple, bolometer, pneumatic detector cell.

Preparation of sample- liquid, solid; characteristic group frequencies.

UNIT-III: UV-Visible Spectroscopy- Practical

Detection of λ_{max} of given organic compounds: aniline, toluene, benzaldehyde, Acetophenone, o-cresol, ethyl acetate.

Determination of indicator constant of an indicator

Determination of band gap of ZnO nanoparticle.

UNIT-IV: IR Spectroscopy-Practical-

Identification of functional groups of organic compounds- urea, benzaldehyde, cinnamic acid, glucose and acetophenone. Determination of the purity of the commercial benzoic acid

- **UNIT-V: Separation Techniques – Practical Handpicking Threshing, Winnowing, Sieving, Evaporation, Distillation, Filtration or Sedimentation, Separating Funnel.**

Reference

A.k Srivastava and p.o jain instrumental approach to chemical analysis 4th edition s.chand &company 2008

I-V

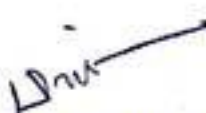
Head of the Department
Department of Chemistry
PRIST Deemed to be University
Vallam, Thanjavur - 613403

DEAN
School of Arts & Science
Ponnaiyah Ramajayam Institute of
Science & Technology (PRIST)
Deemed to be University
Vallam, Thanjavur - 613403

Sl.	Name	Reg. No	19.07.23	20.07.23	21.07.23	24.07.23	25.07.23	26.07.23	27.07.23	28.07.23	31.07.23	01.08.23	02.08.23	03.08.23	04.08.23	07.08.23	08.08.23
1	SANDHIYA M	2201CH10101	/	/	/	/	/	/	/	/	/	/	/	/	/	/	/
2	DURGADEVI G	2201CH10102	/	/	/	/	/	/	/	/	/	/	/	/	/	/	/
3	MAHESH D	2201CH10103	/	/	/	/	/	/	/	/	/	/	/	/	/	/	/
4	BHAVANI M	2201CH10104	/	/	/	/	/	/	/	/	/	/	/	/	/	/	/
5	DEENA D	2201CH10105	/	/	/	/	/	/	/	/	/	/	/	/	/	/	/
6	NARMADHA G	2201CH10106	/	/	/	/	/	/	/	/	/	/	/	/	/	/	/
7	REKHA E	2201CH10107	/	/	/	/	/	/	/	/	/	/	/	/	/	/	/
8	JAMUNA D	2201CH10108	/	/	/	/	/	/	/	A	/	/	/	/	/	/	/
9	DHARANISHAV	2201CH10109	/	/	/	/	/	/	/	/	/	/	/	/	/	/	/
10	GOMATHIESWARI S	2201CH10110	/	/	/	A	/	/	/	/	/	/	/	/	/	/	/
11	SANDHIYA S	2201CH10111	/	/	/	/	/	/	/	/	/	/	/	/	/	/	/
12	ABITHA N	2201CH10112	/	/	/	/	/	/	/	/	/	/	/	/	/	/	/
13	PREETHI M	2201CH10113	/	/	/	/	/	/	/	/	/	/	/	/	/	/	/
14	APARNA D	2201CH10114	/	/	/	/	/	/	/	/	/	/	/	/	/	/	/
15	KAVIYA M	2201CH10115	/	/	/	/	/	A	/	/	/	/	/	/	/	/	/
16	SALINI C	2201CH10116	/	/	/	/	/	/	/	/	/	/	/	/	/	/	/
17	PARTHIBAN D	2201CH10117	/	/	/	/	/	/	/	/	/	/	/	/	/	/	/
18	MUGESH B	2201CH10118	/	/	/	/	/	/	/	/	/	/	/	/	/	/	/
19	BABY D	2201CH10119	/	/	/	/	/	/	/	/	/	/	/	/	/	/	/
20	PUGHAZH E	2201CH10120	/	/	/	/	/	/	/	/	/	/	/	/	/	/	/
21	ROSYA	2201CH10121	/	/	/	/	/	/	/	A	/	/	/	/	/	/	/
22	KAVITHA P	2201CH10122	/	/	/	/	/	/	/	/	/	/	/	/	/	/	/
23	DEVI S	2201CH10123	/	/	/	/	/	/	/	/	/	/	/	/	/	/	/
24	SABEDHKUMAR V	2201CH10124	/	/	/	/	/	/	/	/	/	/	/	/	/	/	/
25	NISHANTH S	2201CH10125	/	/	/	/	/	/	/	/	/	/	/	/	/	/	/
26	JAYASNDHIYA C	2201CH10126	/	/	/	/	/	/	/	/	/	/	/	/	/	/	/
27	POOVARASAN M	2201CH10127	/	/	/	/	/	/	/	/	/	/	/	/	/	/	/
28	ABINAYAR	2201CH10128	/	/	/	/	/	/	/	/	/	/	/	/	/	/	/
29	VANITHA. E	2201CH10129	/	/	/	/	/	/	/	/	/	/	/	/	/	/	/
30	SATHYAPRIYA. V	2201CH10130	/	/	/	/	/	/	/	/	/	/	/	/	/	/	/
31	DINESH. B	2201CH10131	/	/	/	/	/	/	/	/	/	/	/	/	/	/	/
32	WISHNUPRASANTH. S	2201CH10132	/	/	/	/	/	/	/	/	/	/	/	/	/	/	/
33	VASANTHAKUMAR. A	2201CH10133	/	/	/	/	/	/	/	/	/	/	/	/	/	/	/
34	VIVEKANANTHAM. V	2201CH10134	/	/	/	/	/	/	/	/	/	/	/	/	/	/	/
35	RAMKI. P	2201CH10135	/	/	/	/	/	/	/	/	/	/	/	/	/	/	/
36	ARUN. A	2201CH10136	/	/	/	/	/	/	/	/	/	/	/	/	/	/	/
37	SWEDHA. K	2201CH10137	/	/	/	/	/	/	/	/	/	/	/	/	/	/	/
38	SANGEETHA. M	2201CH10138	/	/	/	/	/	/	/	/	/	/	/	/	/	/	/
39	PUSHPARAJ. S	2201CH10139	/	/	/	/	/	/	/	/	/	/	/	/	/	/	/
40	DHINKARAN. R	2201CH10140	/	/	/	/	/	/	/	/	/	/	/	/	/	/	/
41	NETHAJI. P	2201CH10141	/	/	/	/	/	/	/	/	/	/	/	/	/	/	/
42	THAMIZHVANAN. T	2201CH10142	/	/	/	/	/	/	/	/	/	/	/	/	/	/	/
43	VENKATACHALAPATHY. G	2201CH10143	/	/	/	/	/	/	/	/	/	/	/	/	/	/	/
44	PRIYADHARSHINI. M	2201CH10144	/	/	/	/	/	/	/	/	/	/	/	/	/	/	/
45	ABINESH. E	2201CH10145	/	/	/	/	/	/	/	/	/	/	/	/	/	/	/
46	THIRUPATHI. S	2201CH10146	/	/	/	/	/	/	/	/	/	/	/	/	/	/	/
47	SNEKA. L	2201CH10147	/	/	/	/	/	/	/	/	/	/	/	/	/	/	/
48	ABIRAMI. S	2201CH10148	/	/	/	/	/	/	/	/	/	/	/	/	/	/	/

Sl.	Name	Reg. No	09.08.23	10.08.23	11.08.23	14.08.23	16.08.23	17.08.23	18.08.23	21.08.23	22.08.23	23.08.23	24.08.23	25.08.23	28.08.23	29.08.23	30.08.23
1	SANDHIYA M	2201CH10101	/	/	/	/	/	/	/	/	/	/	/	/	/	/	/
2	DURGADEVI G	2201CH10102	/	/	/	/	/	/	/	/	/	/	/	/	/	/	/
3	MAHESH D	2201CH10103	/	/	/	/	/	/	/	/	/	/	/	/	/	/	/
4	BHAVANI M	2201CH10104	/	/	/	/	/	/	/	/	/	/	/	/	/	/	/
5	DEENA D	2201CH10105	/	/	/	/	/	/	/	/	/	/	/	/	/	/	/
6	NARMADHA G	2201CH10106	/	/	/	/	/	/	/	/	/	/	/	/	/	/	/
7	REKHA E	2201CH10107	/	/	/	/	/	/	/	/	/	/	/	/	/	/	/
8	JAMUNA D	2201CH10108	/	/	/	/	/	/	/	/	/	/	/	/	/	/	/
9	DHARANISHA V	2201CH10109	/	/	/	/	/	/	/	/	/	/	/	/	/	/	/
10	GOMATHIESWARI S	2201CH10110	/	/	/	/	/	/	/	/	/	/	/	/	/	/	/
11	SANDHIYA S	2201CH10111	/	/	/	/	/	/	/	/	/	/	/	/	/	/	/
12	ABITHA N	2201CH10112	/	/	/	/	/	/	/	/	/	/	/	/	/	/	/
13	PREETHI M	2201CH10113	/	/	/	/	/	/	/	/	/	/	/	/	/	/	/
14	APARNA D	2201CH10114	/	/	/	/	/	/	/	/	/	/	/	/	/	/	/
15	KAVIYA M	2201CH10115	/	/	/	/	/	/	/	/	/	/	/	/	/	/	/
16	SALINI C	2201CH10116	/	/	/	/	/	/	/	/	/	/	/	/	/	/	/
17	PARTHIBAN D	2201CH10117	/	/	/	/	/	/	/	/	/	/	/	/	/	/	/
18	MUGESH B	2201CH10118	/	/	/	/	/	/	/	/	/	/	/	/	/	/	/
19	BABY D	2201CH10119	/	/	/	/	/	/	/	/	/	/	/	/	/	/	/
20	PUGHAZHE	2201CH10120	/	/	/	/	/	/	/	/	/	/	/	/	/	/	/
21	ROSYA	2201CH10121	/	/	/	/	/	/	/	/	/	/	/	/	/	/	/
22	KAVITHA P	2201CH10122	/	/	/	/	/	/	/	/	/	/	/	/	/	/	/
23	DEVI S	2201CH10123	/	/	/	/	/	/	/	/	/	/	/	/	/	/	/
24	SABEDHKUMAR V	2201CH10124	/	/	/	/	/	/	/	/	/	/	/	/	/	/	/
25	NISHANTH S	2201CH10125	/	/	/	/	/	/	/	/	/	/	/	/	/	/	/
26	JAYASNDHIYA C	2201CH10126	/	/	/	/	/	/	/	/	/	/	/	/	/	/	/
27	POOVARASAN M	2201CH10127	/	/	/	/	/	/	/	/	/	/	/	/	/	/	/
28	ABINAYA R	2201CH10128	/	/	/	/	/	/	/	/	/	/	/	/	/	/	/
29	VANITHA. E	2201CH10129	/	/	/	/	/	/	/	/	/	/	/	/	/	/	/
30	SATHYAPRIYA. V	2201CH10130	/	/	/	/	/	/	/	/	/	/	/	/	/	/	/
31	DINESH. B	2201CH10131	/	/	/	/	/	/	/	/	/	/	/	/	/	/	/
32	VISHNUPRASANTH. S	2201CH10132	/	/	/	/	/	/	/	/	/	/	/	/	/	/	/
33	VASANTHAKUMAR. A	2201CH10133	/	/	/	/	/	/	/	/	/	/	/	/	/	/	/
34	VIVEKANANTHAM. V	2201CH10134	/	/	/	/	/	/	/	/	/	/	/	/	/	/	/
35	RAMKI P	2201CH10135	/	/	/	/	/	/	/	/	/	/	/	/	/	/	/
36	ARUN. A	2201CH10136	/	/	/	/	/	/	/	/	/	/	/	/	/	/	/
37	SWEDHA. K	2201CH10137	/	/	/	/	/	/	/	/	/	/	/	/	/	/	/
38	SANGEETHA. M	2201CH10138	/	/	/	/	/	/	/	/	/	/	/	/	/	/	/
39	PUSHPARAJ. S	2201CH10139	/	/	/	/	/	/	/	/	/	/	/	/	/	/	/
40	DHINKARAN. R	2201CH10140	/	/	/	/	/	/	/	/	/	/	/	/	/	/	/
41	NETHAJI P	2201CH10141	/	/	/	/	/	/	/	/	/	/	/	/	/	/	/
42	THAMIZHVANAN. T	2201CH10142	/	/	/	/	/	/	/	/	/	/	/	/	/	/	/
43	VENKATACHALAPTHI	2201CH10143	/	/	/	/	/	/	/	/	/	/	/	/	/	/	/
44	PRIYADHARSHINI. M	2201CH10144	/	/	/	/	/	/	/	/	/	/	/	/	/	/	/
45	ABINESH. E	2201CH10145	/	/	/	/	/	/	/	/	/	/	/	/	/	/	/
46	THIRUPATHI. S	2201CH10146	/	/	/	/	/	/	/	/	/	/	/	/	/	/	/
47	SNEKA. L	2201CH10147	/	/	/	/	/	/	/	/	/	/	/	/	/	/	/
48	ABIRAMI. S	2201CH10148	/	/	/	/	/	/	/	/	/	/	/	/	/	/	/
49	BALAJI. M	2201CH10149	/	/	/	/	/	/	/	/	/	/	/	/	/	/	/

Sl.	Name	Reg. No	02.02.24	05.02.24	06.02.24	07.02.24	08.02.24	09.02.24	12.02.24	13.02.24	14.02.24	15.02.24	16.02.24	19.02.2	21.02.24	22.02.24	23.02.24
1	S.SAKTHI THARUNAN	2001CH10101	/	/	/	/	/	/	/	/	/	/	/	/	/	/	/
2	Z MOHAMED ARIF	2001CH10102	/	/	/	/	/	/	/	/	/	/	/	/	/	/	/
3	S.BALA KUMAR	2001CH10103	/	/	/	/	/	/	/	/	/	/	/	/	/	/	/
4	P.THANDAYUTHAPA	2001CH10104	/	/	/	/	/	/	/	/	/	/	/	/	/	/	/
5	R.ASHWANTH	2001CH10105	/	/	/	/	/	/	/	/	/	/	/	/	/	/	/
6	P.DHIVAKARAN	2001CH10106	/	/	/	/	/	/	/	/	/	/	/	/	/	/	/
7	MANOJ.V	2001CH10107	/	/	/	/	/	/	/	/	/	/	/	/	/	/	/
8	VISHANTH.V	2001CH10108	/	/	/	/	/	/	/	/	/	/	/	/	/	/	/
9	BHARATHVAJ.B	2001CH10109	/	/	/	/	/	/	/	/	/	/	/	/	/	/	/
10	NITHISHKUMAR AJAY	2001CH10110	/	/	/	/	/	/	/	/	/	/	/	/	/	/	/
11	AJAY R	2001CH10111	/	/	/	/	/	/	/	/	/	/	/	/	/	/	/
12	ANNAMALAIYAR.V	2001CH10112	/	/	/	/	/	/	/	/	/	/	/	/	/	/	/
13	RAJASEKARAN.K	2001CH10113	/	/	/	/	/	/	/	/	/	/	/	/	/	/	/
14	SHANMUGHAM.M	2001CH10114	/	/	/	/	/	/	/	/	/	/	/	/	/	/	/
15	SUBARNAN.K	2001CH10115	/	/	/	/	/	/	/	/	/	/	/	/	/	/	/
16	ABARNA.S	2001CH10116	/	/	/	/	/	/	/	/	/	/	/	/	/	/	/
17	CHARUMATHI.B	2001CH10117	/	/	/	/	/	/	/	/	/	/	/	/	/	/	/
18	NANDHINI.K	2001CH10118	/	/	/	/	/	/	/	/	/	/	/	/	/	/	/
19	NANDHINI.N	2001CH10119	/	/	/	/	/	/	/	/	/	/	/	/	/	/	/
20	JAYANTHI.V	2001CH10120	/	/	/	/	/	/	/	/	/	/	/	/	/	/	/
21	SUBHALAKSHMI.M	2001CH10121	/	/	/	/	/	/	/	/	/	/	/	/	/	/	/
22	KANIMOZHI.G	2001CH10122	/	/	/	/	/	/	/	/	/	/	/	/	/	/	/
23	SONA S	2001CH10123	/	/	/	/	/	/	/	/	/	/	/	/	/	/	/
24	PRIYADHARSHINI R	2001CH10124	/	/	/	/	/	/	/	/	/	/	/	/	/	/	/
25	MERCY R	2001CH10125	/	/	/	/	/	/	/	/	/	/	/	/	/	/	/
26	JOYCE V	2001CH10126	/	/	/	/	/	/	/	/	/	/	/	/	/	/	/
27	ANITHA D	2001CH10127	/	/	/	/	/	/	/	/	/	/	/	/	/	/	/
28	SANDHIYA M	2001CH10128	/	/	/	/	/	/	/	/	/	/	/	/	/	/	/
29	DURGADEVI G	2001CH10129	/	/	/	/	/	/	/	/	/	/	/	/	/	/	/
30	MAHESH D	2001CH10130	/	/	/	/	/	/	/	/	/	/	/	/	/	/	/
31	BHAVANI M	2001CH10131	/	/	/	/	/	/	/	/	/	/	/	/	/	/	/
32	DEENA D	2001CH10132	/	/	/	/	/	/	/	/	/	/	/	/	/	/	/
33	NARMADHA G	2001CH10133	/	/	/	/	/	/	/	/	/	/	/	/	/	/	/
34	REKHA E	2001CH10134	/	/	/	/	/	/	/	/	/	/	/	/	/	/	/
35	JAMUNA D	2001CH10135	/	/	/	/	/	/	/	/	/	/	/	/	/	/	/
36	DHARANISHA V	2001CH10136	/	/	/	/	/	/	/	/	/	/	/	/	/	/	/
37	GOMATHIESWARI S	2001CH10137	/	/	/	/	/	/	/	/	/	/	/	/	/	/	/
38	SANDHIYA S	2001CH10138	/	/	/	/	/	/	/	/	/	/	/	/	/	/	/
39	ABITHA N	2001CH10139	/	/	/	/	/	/	/	/	/	/	/	/	/	/	/
40	PREETHI M	2001CH10140	/	/	/	/	/	/	/	/	/	/	/	/	/	/	/
41	APARNA D	2001CH10141	/	/	/	/	/	/	/	/	/	/	/	/	/	/	/
42	KAVIYA M	2001CH10142	/	/	/	/	/	/	/	/	/	/	/	/	/	/	/
43	SALINI C	2001CH10143	/	/	/	/	/	/	/	/	/	/	/	/	/	/	/
44	PARTHIBAN D	2001CH10144	/	/	/	/	/	/	/	/	/	/	/	/	/	/	/
45	MUGESH B	2001CH10145	/	/	/	/	/	/	/	/	/	/	/	/	/	/	/

Sl.	Name	Reg. No	26.02.2	27.02.2	28.02.2	29.02.2	01.03.2	04.03.2	05.03.2	06.03.2	07.03.2	08.03.2	11.03.2	25.08.2	12.03.2	13.03.2	14.03.2
1	S.SAKTHI THARUNAN	2001CH10101	/	/	/	/	/	/	/	/	/	/	/	/	/	/	/
2	Z MOHAMED ARIF	2001CH10102	/	/	/	/	/	/	/	/	/	/	/	/	/	/	/
3	S.BALA KUMAR	2001CH10103	/	/	/	/	/	/	/	/	/	/	/	/	/	/	/
4	P.THANDAYUTHAPANI	2001CH10104	/	/	/	/	/	/	/	/	/	/	/	/	/	/	/
5	R.ASHWANTH	2001CH10105	/	/	/	/	/	/	/	/	/	/	/	/	/	/	/
6	P.DHIVAKARAN	2001CH10106	/	/	/	/	/	/	/	/	/	/	/	/	/	/	/
7	MANOJ.V	2001CH10107	/	/	/	/	/	/	/	/	/	/	/	/	/	/	/
8	VISHANTH.V	2001CH10108	/	/	/	/	/	/	/	/	/	/	/	/	/	/	/
9	BHARATHVAJ.B	2001CH10109	/	/	/	/	/	/	/	/	/	/	/	/	/	/	/
10	NITHISHKUMAR AJAY.R	2001CH10110	/	/	/	/	/	/	/	/	/	/	/	/	/	/	/
11	AJAY R	2001CH10111	/	/	/	/	/	/	/	/	/	/	/	/	/	/	/
12	ANNAMALAIYAR.V	2001CH10112	/	/	/	/	/	/	/	/	/	/	/	/	/	/	/
13	RAJASEKARAN.K	2001CH10113	/	/	/	/	/	/	/	/	/	/	/	/	/	/	/
14	SHANMUGHAM.M	2001CH10114	/	/	/	/	/	/	/	/	/	/	/	/	/	/	/
15	SUBARNAN.K	2001CH10115	/	/	/	/	/	/	/	/	/	/	/	/	/	/	/
16	ABARNA.S	2001CH10116	/	/	/	/	/	/	/	/	/	/	/	/	/	/	/
17	CHARUMATHI.B	2001CH10117	/	/	/	/	/	/	/	/	/	/	/	/	/	/	/
18	NANDHINI.K	2001CH10118	/	/	/	/	/	/	/	/	/	/	/	/	/	/	/
19	NANDHINI.N	2001CH10119	/	/	/	/	/	/	/	/	/	/	/	/	/	/	/
20	JAYANTHI.V	2001CH10120	/	/	/	/	/	/	/	/	/	/	/	/	/	/	/
21	SUBHALAKSHMI.M	2001CH10121	/	/	/	/	/	/	/	/	/	/	/	/	/	/	/
22	KANIMOZHI.G	2001CH10122	/	/	/	/	/	/	/	/	/	/	/	/	/	/	/
23	SONA S	2001CH10123	/	/	/	/	/	/	/	/	/	/	/	/	/	/	/
24	PRIYADHARSHINI R	2001CH10124	/	/	/	/	/	/	/	/	/	/	/	/	/	/	/
25	MERCY R	2001CH10125	/	/	/	/	/	/	/	/	/	/	/	/	/	/	/
26	JOYCE V	2001CH10126	/	/	/	/	/	/	/	/	/	/	/	/	/	/	/
27	ANITHA D	2001CH10127	/	/	/	/	/	/	/	/	/	/	/	/	/	/	/
28	SANDHIYA M	2001CH10128	/	/	/	/	/	/	/	/	/	/	/	/	/	/	/
29	DURGADEVI G	2001CH10129	/	/	/	/	/	/	/	/	/	/	/	/	/	/	/
30	MAHESH D	2001CH10130	/	/	/	/	/	/	/	/	/	/	/	/	/	/	/
31	BHAVANI M	2001CH10131	/	/	/	/	/	/	/	/	/	/	/	/	/	/	/
32	DEENA D	2001CH10132	/	/	/	/	/	/	/	/	/	/	/	/	/	/	/
33	NARMADHA G	2001CH10133	/	/	/	/	/	/	/	/	/	/	/	/	/	/	/
34	REKHA E	2001CH10134	/	/	/	/	/	/	/	/	/	/	/	/	/	/	/
35	JAMUNA D	2001CH10135	/	/	/	/	/	/	/	/	/	/	/	/	/	/	/
36	DHARANISHA V	2001CH10136	/	/	/	/	/	/	/	/	/	/	/	/	/	/	/
37	GOMATHIESWARI S	2001CH10137	/	/	/	/	/	/	/	/	/	/	/	/	/	/	/
38	SANDHIYA S	2001CH10138	/	/	/	/	/	/	/	/	/	/	/	/	/	/	/
39	ABITHA N	2001CH10139	/	/	/	/	/	/	/	/	/	/	/	/	/	/	/
40	PREETHI M	2001CH10140	/	/	/	/	/	/	/	/	/	/	/	/	/	/	/
41	APARNA D	2001CH10141	/	/	/	/	/	/	/	/	/	/	/	/	/	/	/
42	KAVIYA M	2001CH10142	/	/	/	/	/	/	/	/	/	/	/	/	/	/	/
43	SALINI C	2001CH10143	/	/	/	/	/	/	/	/	/	/	/	/	/	/	/
44	PARTHIBAN D	2001CH10144	/	/	/	/	/	/	/	/	/	/	/	/	/	/	/
45	MUGESH B	2001CH10145	/	/	/	/	/	/	/	/	/	/	/	/	/	/	/

Sl.	Name	Reg. No	02.02.24	05.02.24	06.02.24	07.02.24	08.02.24	09.02.24	12.02.24	13.02.24	14.02.24	15.02.24	16.02.24	19.02.2	21.02.24	22.02.24	23.02.24
1	V.JOTHIKA	2101CH10101	/	/	/	/	/	/	/	/	/	/	/	/	/	/	/
2	V.SOWNDHARYA	2101CH10102	/	/	/	/	/	/	/	/	/	/	/	/	/	/	/
3	S.LENCY	2101CH10103	/	/	/	/	/	/	/	/	/	/	/	/	/	/	/
4	G.REKHA	2101CH10104	/	/	/	/	/	/	/	/	/	/	/	/	/	/	/
5	S.Abipriya	2101CH10105	/	/	/	/	/	/	/	/	/	/	/	/	/	/	/
6	P.Krupa	2101CH10106	/	/	/	/	/	/	/	/	/	/	/	/	/	/	/
7	D.Sasikala	2101CH10107	/	/	/	/	/	/	/	/	/	/	/	/	/	/	/
8	R.Srinithi	2101CH10108	/	/	/	/	/	/	/	/	/	/	/	/	/	/	/
9	P.Deepakkumar	2101CH10109	/	/	/	/	/	/	/	/	/	/	/	/	/	/	/
10	A.B.Thamizhazhgan	2101CH10110	/	/	/	/	/	/	/	/	/	/	/	/	/	/	/
11	S.Seerazhagan	2101CH10111	/	/	/	/	/	/	/	/	/	/	/	/	/	/	/
12	M. Pandeewari	2101CH10112	/	/	/	/	/	/	/	/	/	/	/	/	/	/	/
13	K. Gayathiri	2101CH10113	/	/	/	/	/	/	/	/	/	/	/	/	/	/	/
14	M. Vithya	2101CH10114	/	/	/	/	/	/	/	/	/	/	/	/	/	/	/
15	A.Swathi	2101CH10115	/	/	/	/	/	/	/	/	/	/	/	/	/	/	/
16	M. Anburaja	2101CH10116	/	/	/	/	/	/	/	/	/	/	/	/	/	/	/
17	A. Viswanathan	2101CH10117	/	/	/	/	/	/	/	/	/	/	/	/	/	/	/
18	B. Oorkavaln	2101CH10118	/	/	/	/	/	/	/	/	/	/	/	/	/	/	/
19	M. Praveena	2101CH10119	/	/	/	/	/	/	/	/	/	/	/	/	/	/	/
20	T. Vedhavalli	2101CH10120	/	/	/	/	/	/	/	/	/	/	/	/	/	/	/
21	A. Vinothini	2101CH10121	/	/	/	/	/	/	/	/	/	/	/	/	/	/	/
22	R. Samathuvakannan	2101CH10122	/	/	/	/	/	/	/	/	/	/	/	/	/	/	/
23	A.Arunkumar	2101CH10123	/	/	/	/	/	/	/	/	/	/	/	/	/	/	/
24	A.Asha	2101CH10124	/	/	/	/	/	/	/	/	/	/	/	/	/	/	/
25	S. Kalpana	2101CH10125	/	/	/	/	/	/	/	/	/	/	/	/	/	/	/
26	A. Kanishkar	2101CH10126	/	/	/	/	/	/	/	/	/	/	/	/	/	/	/
27	A.Kathiravan	2101CH10127	/	/	/	/	/	/	/	/	/	/	/	/	/	/	/
28	V. Keerthana	2101CH10128	/	/	/	/	/	/	/	/	/	/	/	/	/	/	/
29	J. Kirubakaran	2101CH10129	/	/	/	/	/	/	/	/	/	/	/	/	/	/	/
30	V. Lavanya	2101CH10130	/	/	/	/	/	/	/	/	/	/	/	/	/	/	/
31	K. Meenatchi	2101CH10131	/	/	/	/	/	/	/	/	/	/	/	/	/	/	/
32	C.MOHAN	2101CH10132	/	/	/	/	/	/	/	/	/	/	/	/	/	/	/
33	D. MOWLEESWARI	2101CH10133	/	/	/	/	/	/	/	/	/	/	/	/	/	/	/
34	M. NANDHINI	2101CH10134	/	/	/	/	/	/	/	/	/	/	/	/	/	/	/
35	S. PRAMILA	2101CH10135	/	/	/	/	/	/	/	/	/	/	/	/	/	/	/
36	R. PREETHA	2101CH10136	/	/	/	/	/	/	/	/	/	/	/	/	/	/	/
37	K. RAGUL	2101CH10137	/	/	/	/	/	/	/	/	/	/	/	/	/	/	/
38	P. RAJESH KUMAR	2101CH10138	/	/	/	/	/	/	/	/	/	/	/	/	/	/	/
39	R. RANJITH KUMAR	2101CH10139	/	/	/	/	/	/	/	/	/	/	/	/	/	/	/
40	P. SOWMIYA	2101CH10140	/	/	/	/	/	/	/	/	/	/	/	/	/	/	/
41	S. SRIDEVI	2101CH10141	/	/	/	/	/	/	/	/	/	/	/	/	/	/	/
42	S. SRIDEVI	2101CH10142	/	/	/	/	/	/	/	/	/	/	/	/	/	/	/
43	R. THIRUVARASI	2101CH10143	/	/	/	/	/	/	/	/	/	/	/	/	/	/	/
44	S. VIGNESH	2101CH10144	/	/	/	/	/	/	/	/	/	/	/	/	/	/	/
45	NANDHINI.N	2101CH10145	/	/	/	/	/	/	/	/	/	/	/	/	/	/	/
46	JAYANTHI.V	2101CH10146	/	/	/	/	/	/	/	/	/	/	/	/	/	/	/
47	SUBHALAKSHMI.M	2101CH10147	/	/	/	/	/	/	/	/	/	/	/	/	/	/	/

Sl.	Name	Reg. No	26.02.2	27.02.2	28.02.2	29.02.2	01.03.2	04.03.2	05.03.2	06.03.2	07.03.2	08.03.2	11.03.2	25.08.2	12.03.2	13.03.2	14.03.2
1	V.JOTHIKA	2101CH10101	/	/	/	/	/	/	/	/	/	/	/	/	/	/	/
2	V.SOWNDHARYA	2101CH10102	/	/	/	/	/	/	/	/	/	/	/	/	/	/	/
3	S.LENCY	2101CH10103	/	/	/	/	/	/	/	/	/	/	/	/	/	/	/
4	G.REKHA	2101CH10104	/	/	/	/	/	/	/	/	/	/	/	/	/	/	/
5	S.Abipriya	2101CH10105	/	/	/	/	/	/	/	/	/	/	/	/	/	/	/
6	P.Krupa	2101CH10106	/	/	/	/	/	/	/	/	/	/	/	/	/	/	/
7	D.Sasikala	2101CH10107	/	/	/	/	/	/	/	/	/	/	/	/	/	/	/
8	R.Srinithi	2101CH10108	/	/	/	/	/	/	/	/	/	/	/	/	/	/	/
9	P.Deepakkumar	2101CH10109	/	/	/	/	/	/	/	/	/	/	/	/	/	/	/
10	A.B.Thamizhazhgan	2101CH10110	/	/	/	/	/	/	/	/	/	/	/	/	/	/	/
11	S.Seerazhagan	2101CH10111	/	/	/	/	/	/	/	/	/	/	/	/	/	/	/
12	M. Pandeewari	2101CH10112	/	/	/	/	/	/	/	/	/	/	/	/	/	/	/
13	K. Gayathiri	2101CH10113	/	/	/	/	/	/	/	/	/	/	/	/	/	/	/
14	M. Vithya	2101CH10114	/	/	/	/	/	/	/	/	/	/	/	/	/	/	/
15	A.Swathi	2101CH10115	/	/	/	/	/	/	/	/	/	/	/	/	/	/	/
16	M. Anburaja	2101CH10116	/	/	/	/	/	/	/	/	/	/	/	/	/	/	/
17	A. Viswanathan	2101CH10117	/	/	/	/	/	/	/	/	/	/	/	/	/	/	/
18	B. Oorkavaln	2101CH10118	/	/	/	/	/	/	/	/	/	/	/	/	/	/	/
19	M. Praveena	2101CH10119	/	/	/	/	/	/	/	/	/	/	/	/	/	/	/
20	T. Vedhavalli	2101CH10120	/	/	/	/	/	/	/	/	/	/	/	/	/	/	/
21	A. Vinothini	2101CH10121	/	/	/	/	/	/	/	/	/	/	/	/	/	/	/
22	R. Samathuvakannan	2101CH10122	/	/	/	/	/	/	/	/	/	/	/	/	/	/	/
23	A.Arunkumar	2101CH10123	/	/	/	/	/	/	/	/	/	/	/	/	/	/	/
24	A.Asha	2101CH10124	/	/	/	/	/	/	/	/	/	/	/	/	/	/	/
25	S. Kalpana	2101CH10125	/	/	/	/	/	/	/	/	/	/	/	/	/	/	/
26	A. Kanishkar	2101CH10126	/	/	/	/	/	/	/	/	/	/	/	/	/	/	/
27	A.Kathiravan	2101CH10127	/	/	/	/	/	/	/	/	/	/	/	/	/	/	/
28	V. Keerthana	2101CH10128	/	/	/	/	/	/	/	/	/	/	/	/	/	/	/
29	J. Kirubakaran	2101CH10129	/	/	/	/	/	/	/	/	/	/	/	/	/	/	/
30	V. Lavanya	2101CH10130	/	/	/	/	/	/	/	/	/	/	/	/	/	/	/
31	K. Meenatchi	2101CH10131	/	/	/	/	/	/	/	/	/	/	/	/	/	/	/
32	C.MOHAN	2101CH10132	/	/	/	/	/	/	/	/	/	/	/	/	/	/	/
33	D. MOWLEESWARI	2101CH10133	/	/	/	/	/	/	/	/	/	/	/	/	/	/	/
34	M. NANDHINI	2101CH10134	/	/	/	/	/	/	/	/	/	/	/	/	/	/	/
35	S. PRAMILA	2101CH10135	/	/	/	/	/	/	/	/	/	/	/	/	/	/	/
36	R. PREETHA	2101CH10136	/	/	/	/	/	/	/	/	/	/	/	/	/	/	/
37	K. RAGUL	2101CH10137	/	/	/	/	/	/	/	/	/	/	/	/	/	/	/
38	P. RAJESH KUMAR	2101CH10138	/	/	/	/	/	/	/	/	/	/	/	/	/	/	/
39	R. RANJITH KUMAR	2101CH10139	/	/	/	/	/	/	/	/	/	/	/	/	/	/	/
40	P. SOWMIYA	2101CH10140	/	/	/	/	/	/	/	/	/	/	/	/	/	/	/
41	S. SRIDEVI	2101CH10141	/	/	/	/	/	/	/	/	/	/	/	/	/	/	/
42	S. SRIDEVI	2101CH10142	/	/	/	/	/	/	/	/	/	/	/	/	/	/	/
43	R. THIRUVARASI	2101CH10143	/	/	/	/	/	/	/	/	/	/	/	/	/	/	/
44	S. VIGNESH	2101CH10144	/	/	/	/	/	/	/	/	/	/	/	/	/	/	/
45	NANDHINI.N	2101CH10145	/	/	/	/	/	/	/	/	/	/	/	/	/	/	/
46	JAYANTHI.V	2101CH10146	/	/	/	/	/	/	/	/	/	/	/	/	/	/	/
47	SUBHALAKSHMI.M	2101CH10147	/	/	/	/	/	/	/	/	/	/	/	/	/	/	/

Sl.	Name	Reg. No	02.02.24	05.02.24	06.02.24	07.02.24	08.02.24	09.02.24	12.02.24	13.02.24	14.02.24	15.02.24	16.02.24	19.02.24	21.02.24	22.02.24	23.02.24
1	B.Praveen	2201CH20101	/	/	/	/	/	/	/	/	/	/	/	/	/	/	/
2	M.Natarajan	2201CH20102	/	/	/	/	/	/	/	/	/	/	/	/	/	/	/
3	GUNASUNDHARI.G	2201CH20103	/	/	/	/	/	/	/	/	/	/	/	/	/	/	/
4	JAYAPRAKASH.J	2201CH20104	/	/	/	/	/	/	/	/	/	/	/	/	/	/	/
5	THIRUMARAN.K	2201CH20105	/	/	/	/	/	/	/	/	/	/	/	/	/	/	/
6	UNNIKRISHNAN.R	2201CH20106	/	/	/	/	/	/	/	/	/	/	/	/	/	/	/
7	NITHISHKUMAR.K	2201CH20107	/	/	/	/	/	/	/	/	/	/	/	/	/	/	/
8	THIRUNAVALAN.N	2201CH20108	/	/	/	/	/	/	/	/	/	/	/	/	/	/	/
9	LENIN.G	2201CH20109	/	/	/	/	/	/	/	/	/	/	/	/	/	/	/
10	KRISHNAKUMAR.K	2201CH20110	/	/	/	/	/	/	/	/	/	/	/	/	/	/	/
11	PARTHIBAN.P	2201CH20111	/	/	/	/	/	/	/	/	/	/	/	/	/	/	/
12	DHANASEKARAN.S	2201CH20112	/	/	/	/	/	/	/	/	/	/	/	/	/	/	/
13	KALAIMATHI.S	2201CH20113	/	/	/	/	/	/	/	/	/	/	/	/	/	/	/
14	BHUVANA.R	2201CH20114	/	/	/	/	/	/	/	/	/	/	/	/	/	/	/
15	BHARANIVENDHAN.H	2201CH20115	/	/	/	/	/	/	/	/	/	/	/	/	/	/	/
16	DEEPIGA.P	2201CH20116	/	/	/	/	/	/	/	/	/	/	/	/	/	/	/
17	SAVUNDARY.A	2201CH20117	/	/	/	/	/	/	/	/	/	/	/	/	/	/	/
18	SOWMYA.C	2201CH20118	/	/	/	/	/	/	/	/	/	/	/	/	/	/	/
19	SATHEESKUMAR.G	2201CH20119	/	/	/	/	/	/	/	/	/	/	/	/	/	/	/
20	MADHUMITHA.M	2201CH20120	/	/	/	/	/	/	/	/	/	/	/	/	/	/	/

Sl.	Name	Reg. No	26.02.24	27.02.24	28.02.24	29.02.24	01.03.24	04.03.24	05.03.24	06.03.24	07.03.24	08.03.24	11.03.24	25.03.24	12.03.24	13.03.24	14.03.24
1	B.Praveen	2201CH20101	/	/	/	/	/	/	/	/	/	/	/	/	/	/	/
2	M.Natarajan	2201CH20102	/	/	/	/	/	/	/	/	/	/	/	/	/	/	/
3	GUNASUNDHARI.G	2201CH20103	/	/	/	/	/	/	/	/	/	/	/	/	/	/	/
4	JAYAPRAKASH.J	2201CH20104	/	/	/	/	/	/	/	/	/	/	/	/	/	/	/
5	THIRUMARAN.K	2201CH20105	/	/	/	/	/	/	/	/	/	/	/	/	/	/	/
6	UNNIKRISHNAN.R	2201CH20106	/	/	/	/	/	/	/	/	/	/	/	/	/	/	/
7	NITHISHKUMAR.K	2201CH20107	/	/	/	/	/	/	/	/	/	/	/	/	/	/	/
8	THIRUNAVLAN.N	2201CH20108	/	/	/	/	/	/	/	/	/	/	/	/	/	/	/
9	LENIN.G	2201CH20109	/	/	/	/	/	/	/	/	/	/	/	/	/	/	/
10	KRISHNAKUMAR.K	2201CH20110	/	/	/	/	/	/	/	/	/	/	/	/	/	/	/
11	PARTHIBAN.P	2201CH20111	/	/	/	/	/	/	/	/	/	/	/	/	/	/	/
12	DHANASEKARAN.S	2201CH20112	/	/	/	/	/	/	/	/	/	/	/	/	/	/	/
13	KALAIMATHI.S	2201CH20113	/	/	/	/	/	/	/	/	/	/	/	/	/	/	/
14	BHUVANA.R	2201CH20114	/	/	/	/	/	/	/	/	/	/	/	/	/	/	/
15	BHARANIVENDHAN.H	2201CH20115	/	/	/	/	/	/	/	/	/	/	/	/	/	/	/
16	DEEPIGA.P	2201CH20116	/	/	/	/	/	/	/	/	/	/	/	/	/	/	/
17	SAVUNDARY.A	2201CH20117	/	/	/	/	/	/	/	/	/	/	/	/	/	/	/
18	SOWMYA.C	2201CH20118	/	/	/	/	/	/	/	/	/	/	/	/	/	/	/
19	SATHEESKUMAR.G	2201CH20119	/	/	/	/	/	/	/	/	/	/	/	/	/	/	/
20	MADHUMITHA.M	2201CH20120	/	/	/	/	/	/	/	/	/	/	/	/	/	/	/





**PONNAIYAH RAMAJAYAM INSTITUTE OF
SCIENCE & TECHNOLOGY (PRIST)**

Declared as DEEMED-TO-BE-UNIVERSITY
U/s 3 of UGC Act, 1956

CERTIFICATE OF COMPLETION

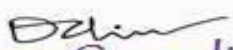
This is to certify that **Mr. / Ms. Annamalaiyar. V (2001CH10112)** studying in B.Sc., Chemistry having successfully completed the Value-Added / Skill Enhancement Course, Certificate course in Crystallization and Chromatography Techniques conducted by the department of Chemistry, during the Academic Year **2023-2024**.

Course Co-ordinator

Convener
Head of the Department
Department of Chemistry
PRIST Deemed to be University
Vellam, Thanjavur - 613403

Dean
School of Arts & Science
Ponnaiyah Ramajayam Institute of
Science & Technology (PRIST)
Deemed to be University
Vallam, Thanjavur - 613 403.





PONNAIYAH RAMAJAYAM INSTITUTE OF SCIENCE & TECHNOLOGY (PRIST)

Declared as DEEMED-TO-BE-UNIVERSITY
U/s 3 of UGC Act, 1956

CERTIFICATE OF COMPLETION

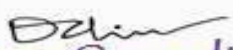
This is to certify that **Mr. / Ms. Mr. / Ms. A.B. Thamizhazhgan (2101CH10110)** studying in B.Sc., Chemistry having successfully completed the Value – Added / Skill Enhancement Course, Certificate course Water Resource, Management and Water Pollution Health conducted by the department of Chemistry, during the Academic Year **2023-2024**.

Course Co-ordinator

Convener
Head of the Department
Department of Chemistry
PRIST Deemed to be University
Vallam, Thanjavur - 613403

Dean
School of Arts & Science
Ponnaiyah Ramajayam Institute of
Science & Technology (PRIST)
Deemed to be University
Vallam, Thanjavur - 613 403.



**PONNAIYAH RAMAJAYAM INSTITUTE OF
SCIENCE & TECHNOLOGY (PRIST)**

Declared as DEEMED-TO-BE-UNIVERSITY
U/s 3 of UGC Act, 1956

CERTIFICATE OF COMPLETION

This is to certify that **Mr. / Ms. Durgadevi. G (2201CH10102)** studying in B.Sc., Chemistry having successfully completed the Value – Added / Skill Enhancement Course, Certificate course Drug Design by the department of Chemistry, during the Academic Year **2023-2024**.

D. Srinivas
Course Co-ordinator

N. Srinivas
Convener
Head of the Department
Department of Chemistry
PRIST Deemed to be University
Vallam, Thanjavur - 613403

D. Srinivas
Dean
School of Arts & Science
Ponnaiyah Ramajayam Institute of
Science & Technology (PRIST)
Deemed to be University
Vallam, Thanjavur - 613 403.





PONNAIYAH RAMAJAYAM INSTITUTE OF SCIENCE & TECHNOLOGY (PRIST)

Declared as DEEMED-TO-BE-UNIVERSITY
U/s 3 of UGC Act, 1956

CERTIFICATE OF COMPLETION

This is to certify that **Mr. / Ms. Prithviraj.E (2101CH202112)** studying in M.Sc., Chemistry having successfully completed the Value-Added / Skill Enhancement Course, Diploma Course on Sustainable Development conducted by the department of Chemistry, during the Academic Year **2023-2024**.

Course Co-ordinator

Convener
Head of the Department
Department of Chemistry
PRIST Deemed to be University
Vallam, Thanjavur - 613403

Dean
School of Arts & Science
Ponnaiyah Ramajayam Institute of
Science & Technology (PRIST)
Deemed to be University
Vallam, Thanjavur - 613 403.





PONNAIYAH RAMAJAYAM INSTITUTE OF SCIENCE & TECHNOLOGY (PRIST)

Declared as DEEMED-TO-BE-UNIVERSITY
U/s 3 of UGC Act, 1956

CERTIFICATE OF COMPLETION

This is to certify that **Mr. / Ms. Nithishkumar. K (2201CH20107)** studying in M.Sc., Chemistry having successfully completed the Value – Added / Skill Enhancement Course, Diploma Course on UV-Visible, I. R. Spectroscopic Instrumentation & Separation Techniques conducted by the department of Chemistry, during the Academic Year **2023-2024**.

Course Co-ordinator

Convener
Head of the Department
Department of Chemistry
PRIST Deemed to be University
Vallam, Thanjavur - 613403

Dean
School of Arts & Science
Ponnaiyah Ramajayam Institute of
Science & Technology (PRIST)
Deemed to be University
Vallam, Thanjavur - 613 403.



**PONNAIYAH RAMAJAYAM INSTITUTE OF
SCIENCE & TECHNOLOGY (PRIST)**

Declared as DEEMED-TO-BE-UNIVERSITY
U/s 3 of UGC Act, 1956

**SCHOOL OF ARTS AND SCIENCE
DEPARTMENT OF COMPUTER SCIENCE**

CIRCULAR

This is inform to B.Sc[CS] and B.C.A - (I,II and III year) students that the value added programme classes for academic year 2023-2024 semesters I,III and V will be commenced from 10.07.2023. Hence requesting all the registered students to attend the classes without fail.

BRANCH NAME	YEAR	COURSE OFFERED
Computer Science and Computer Applications	I B.Sc[CS] II B.Sc[CS] III B.Sc[CS] I BCA II BCA III BCA	Certificate course on Designing [Photoshop, Premium, Illustrator]
		Certificate course on Web Application Development And Hosting
		Certificate course on Android App Development
		Certificate course on Software Testing using Selenium
		Diploma course on R / WEKA TOOL
		Diploma course on Web Designing & Hosting
		Diploma course on AI and ML using pytorch

HOD

HOD
Department of Computer Science
School of Arts and Science
Ponnaiyah Ramajayam Institute of
Science and Technology (PRIST)
Thanjavur - 613 403.

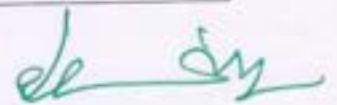
DEAN

DEAN
School of Arts & Science
Ponnaiyah Ramajayam Institute of
Science & Technology (PRIST)
Deemed to be University
Vailankulam, Thanjavur - 613 403.



**PONNAIYAH RAMAJAYAM INSTITUTE OF
SCIENCE & TECHNOLOGY (PRIST)**

Declared as DEEMED-TO-BE UNIVERSITY
U/s 3 of UGC Act, 1956

**SCHOOL OF ARTS AND SCIENCE
DEPARTMENT OF COMPUTER SCIENCE**

CIRCULAR

This is inform to B.Sc[CS] and B.C.A - (II,IV and VI year) students that the value added programme classes for academic year 2023-2024 semesters II,IV and VI will be commenced from 19.01.2024. Hence requesting all the registered students to attend the classes without fail.

BRANCH NAME	YEAR	COURSE OFFERED
Computer Science and Computer Applications	I B.Sc[CS]	Certificate course on Google IT Support
	II B.Sc[CS] III B.Sc[CS]	Certificate course on Introduction to Cyber Security and Cyber Attacks
	I BCA II BCA III BCA	Certificate course on Block Chain technology

HOD

HOD
Department of Computer Science
School of Arts and Science
Ponnaiyah Ramajayam Institute of
Science and Technology (PRIST)
Thanjavur - 613 403.

DEAN

DEAN
School of Arts & Science
Ponnaiyah Ramajayam Institute of
Science & Technology (PRIST)
Deemed to be University
Vaitern, Thanjavur - 613 403.



ADD-ON COURSES

Certificate in Designing
Photoshop, Premium,
Illustrator

PRIST

Deemed to be University, Vall
Thanjavur -613 403

DEAN

School of Arts & Science
Ponnaiyah Ramajayam Institute of
Science & Technology (PRIST)
Deemed to be University
Vallam, Thanjavur - 613 403.

About the University

Ponnaiyah Ramajayam Institute of Science and Technology (PRIST) is a deemed university in Vallam, India. The institute offers undergraduate and postgraduate courses in Engineering, Science, Education, Management, Arts, and Law, as well as research programmes.

Facilities Available

Not all graphic designers hold a specialized degree, and this lack of a degree requirement may be confusing when trying to determine how to succeed without one. If you've looked into online graphic design certification programs, you might wonder which certification would advance a career in graphic design.

Fortunately, official programs like Adobe Certified Professional enable aspiring graphic designers to become certified in Illustrator and other Creative Cloud apps through hands-on training and testing. As an Adobe Certified Professional, you can demonstrate your expertise and credibility as a graphic designer.

Name :
 Programme :
 Discipline :
 Institution Name:
 Date of Birth :
 Gender (M/F) :
 E. Mail Id :
 Mobile No :
 Permanent Address :

Signature of the Applicant

Submission of Application Form

Submit your Application form in person to the co-ordinator, School of Arts and Science, PRIST University, Thanjavur, Vallam, 613 403.

Application may be send to

Course Co-Ordinator

The Head of the Department
 Department of Computer Science
 PRIST University, Thanjavur.
 E-mail: pristestnj@gmail.com

HOD

Department of Computer Science
 School of Arts and Science
 Ponnaiyah Ramajayam Institute of
 Science and Technology (PRIST)
 Thanjavur - 613 403.

COURSE OBJECTIVE

The purpose of machine learning is to discover patterns in your data and then make predictions based on often complex findings to answer business questions, detect and analyse trends and help solve problems

The goal of artificial intelligence (AI) and machine learning is to program computers to use example data or experience to solve a given problem..

To understand the basic theory underlying machine learning. To be able to formulate machine learning problems corresponding to different applications. To understand a range of machine learning algorithms along with their strengths and weaknesses.

ELIGIBILITY CRITERIA

Any graduate shall be eligible for the admission to the course Intake Capacity 15 Seats on first cum first basis (Additional admission to the course is prerogative of the school)

COURSE DURATION (45 Hrs)

1. Adobe Certified Professional in Visual Design
 - A. Photoshop
 1. Photoshop Crash Course
 2. Selections and Masks
 3. Reconstructing and Retouching
 4. More Layers and Selections
 5. Brushes and Painting
 6. Working in the Design Industry
 - B. Illustrator
 1. The Illustrator Interface
 2. Getting Started
 3. Organizing a Project
 4. Creating Advanced Illustrations
- HOD** Advanced Management of
Department of Computer Science
School of Arts and Sciences
Ponnyiah Ramajayam Institute of
Science and Technology (PRIST)
Thanjavur - 613 403.

8. Sharing Your Project
 9. Working In the Design Industry
- C. InDesign
1. Crash Course
 2. Creating An Invitation
 3. Creating A Book Chapter
 4. Text
 5. Styles
 6. Images and Colors
 7. Completing Documents
 8. Tables
 9. Preflight And Export
 10. Forms
 11. Working In the Design Industry

EXAMINATION

1. Every student has to give periodic tests consisting of Programming tasks and Objective Questions
2. At the end of the Course each student will give a presentation on a topic covered in the course

COURSE STRUCTURE AND DURATION

- Course is 6 month duration and will be of 45 hrs imparted training programme covering theoretical and practical aspects of Adobe photoshop.

Eligibility criteria for appearing in the in the final examination

- Minimum Attendance - 80%
Minimum Internal Assessment marks - 40%
• It will be done through the whole year. Candidate must obtain at least 35% marks in theory internal assessment to be eligible for the university examination.

Internal assessment will be done as follows:

- a) Mid-term and term examinations = 10 marks
- b) Assignments/Projects/Class test/Clinical Presentations = 05 marks

c) Attendance = 05 marks
Total = 20 marks

Criteria for a pass in the subject
Minimum marks in theory - 45

SCHEME OF EXAMINATION:-

Duration of written examination - 3 hrs
Maximum marks - 100

CERTIFICATION

The candidates successfully qualifying the course shall be awarded a certificate to that effect in the appropriate form by School of Arts and Science, Department of Computer Science, PRIST University, Thanjavur, Vallam.

COURSE OUTCOMES

- Appreciate the importance of visualization in the data analytics solution
- Apply structured thinking to unstructured problems
- Understand a very broad collection of machine learning algorithms and problems
- Learn algorithmic topics of machine learning and mathematically deep enough to introduce the required theory
- Develop an appreciation for what is involved in learning data.

DEAN

School of Arts & Science
Ponnyiah Ramajayam Institute of
Science & Technology (PRIST)
Thanjavur - 613 403.

Full Name _____
 Programme _____
 Discipline _____
 Institution Name _____
 Date of Birth _____
 Gender (M/F) _____
 E-Mail Id _____
 Mobile No _____
 Permanent Address _____



**PENNAIYAH RAMAJAYAM INSTITUTE
 SCIENCE & TECHNOLOGY (PRIST)**

Deemed to be UNIVERSITY
 DATED APR 08, 2015

Signature of the Applicant _____

About the University

Pennaiyah Ramajayam Institute of Science and Technology (PRIST) is a deemed university in Vallam, India. The institute offers undergraduate and postgraduate courses in Engineering, Science, Education, Management, Arts, and Law, as well as research programmes.

Facilities Available

The Department of Computing has highly sophisticated computing facilities for training and R&D work in various areas of Computer Science & Information Technology applications. The facilities available include Parallel Programming, Software Engineering & Testing, Computer Graphics, Multimedia & 3D, AutoCAD, Image Processing, Networking, Various Operating Systems, GUI, Distributed Computing, DoTnet. The Department of Computing has signed Memoranda with IBM for Python, IoT, Machine Learning, Artificial intelligent and Big data Analytics training.



**ADD-ON COURSES
 DIPLOMA IN WEB
 APPLICATION
 DEVELOPMENT AND
 HOSTING**

**PRIST
 Deemed to be University, Vallam,
 Thanjavur -613 403**

Submission of Application Form

Submit your Application form in person to the co-ordinator, School of Arts and Science, PRIST University, Thanjavur, Vallam, 613 403.

Application may be send to

Course Co-Ordinator

Prof. Gayathri G
 Assistant Professor
 Department of Computer Science
 PRIST University, Thanjavur
 E-mail: pristcso@gmail.com

**HOD
 Department of Computer Science
 School of Arts and Science
 Pennaiyah Ramajayam Institute of
 Science and Technology (PRIST)
 Thanjavur - 613 403.**

**DEAN
 School of Arts & Science
 Pennaiyah Ramajayam Institute of
 Science & Technology (PRIST)
 Deemed to be University
 Vallam, Thanjavur - 613 403.**

COURSE OBJECTIVE

Specialization track involving Web Application Architectures. This course will give you the basic background, terminology and fundamental concepts that you need to understand in order to build modern full stack web applications. A full stack web developer is familiar with each "layer" of the software technologies involved in a web application, including data modeling and database technologies, the web server environment and middleware components, network protocols, the user interface and basic visual design and user interaction concepts.

ELIGIBILITY CRITERIA

Any graduate shall be eligible for the admission to the course Intake Capacity 15 Seats on first come first basis (Additional admission to the course is prerogative of the school)

COURSE DURATION (45 hrs)

Module #1 - Web Applications in Context

This module sets the context for what we will study in this specialization by first providing a historical perspective on computing and web applications. Next we provide an overview of how the Internet works, and then we discuss how web applications have evolved over the past few decades. After that we'll discuss some of the elements of modern software practice, including the typical tools that software engineers now use and the agile development practices they follow. The notion of software design patterns will be introduced, and the other architecture design pattern,

fundamental to modern web application design, is then presented. Will also discuss a few current topics related to web application development. Finally, we will show you how to set up the software development environment you will use throughout the remainder of the courses in this

Module #2 - Web Applications Frameworks

In this module you will learn about web application frameworks. We will start by talking about the evolution of software and programming languages, and then talk about software application frameworks. The fundamental trade-off we will consider is programmer productivity versus program efficiency. Next you will learn about web application frameworks, as well as the model-view-controller design pattern that is the backbone for many of these frameworks. We will also consider how these frameworks support the agile programming principles associated with modern software practice. This will include a discussion of distributed version control systems and you will learn how to use the popular Git system. We will also demonstrate how to use Git with a Ruby on Rails application. We will use Git to submit all of the programming applications in this specialization.

Module #3 - Managing Data

A successful web application provides information to users that is (1) useful, and also (2) easy to access and understand. This information is often collected from users, as well as from other information sources, and must be stored in a manner that allows it to be manipulated by the web application. The typical app approach is to store this data in a relational database. In this module you will

learn some basic concepts associated with managing the data in a web application, including how to specify the relationships between various data entities. We will also investigate how to hook a web application up to a back-end data store, along with good design techniques that will make it easier to use the data in your web applications by maintaining consistency throughout the entire web stack.

Module #4 - Middleware

Middleware is an abstraction layer that hides details about hardware devices and other lower-level software services from an application. Middleware services implement common low-level functions, such as communication with the operating system, application servers, database servers, etc., so that application developers do not need to concern themselves with these details, and can instead focus on the application functionality they are trying to provide. In a web application, these services generally make use of the HTTP protocol, and in a web application framework, the MVC design pattern can be thought of as being implemented over the middleware.

Module #5 - The User Interface

In our final module we will discuss the User Interface. We will touch on CSS and JavaScript, and how these are used to add style to layout and design of HTML documents. We will also learn about Ajax and how it improves user requests.



HOD

Department of Computer Science
School of Arts and Science
Ponnalyah Ramejyam Institute of
Science and Technology (PRIST)
Thanjavur - 613 403.

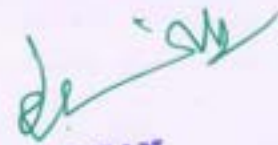

DEAN

School of Arts & Science
Ponnalyah Ramejyam Institute
Science & Technology (PRIST)
Deemed to be University
Thanjavur - 613-403.



Full Name :

Programme :

Discipline :

Institution Name:

Date of Birth :

Gender (M/F) :

E. Mail Id :

Mobile No :

Permanent Address :

.....

.....

Ponnaiyah Ramajayam Institute of Science and Technology (PRIST) is a deemed university in Vallam, India. The institute offers undergraduate and postgraduate courses in Engineering, Science, Education, Management, Arts, and Law, as well as research programmes.

Facilities Available

The Department of Computing has highly sophisticated computing facilities for training and R&D work in various areas of Computer Science & Information Technology applications. The facilities available include Parallel Programming, Software Engineering & Testing, Computer Graphics, Multimedia & 3D, AutoCAD, Image Processing, Networking, Various Operating Systems, GUI, Distributed Computing, DoTnet. The Department of Computing has signed Memoranda with IBM for Python, IoT, Machine Learning, Artificial intelligent and Big data Analytics training.

Signature of the Applicant

Submission of Application Form

Submit your Application form in person to the co-ordinator, School of Arts and Science, PRIST University, Thanjavur, Vallam, 613 403.

Application may be send to

Course Co-Ordinator

The Head of the Department
Department of Computer Science
PRIST University, Thanjavur.

E. mail: pristestn1@gmail.com
Department of Computer Science
School of Arts and Science
Ponnaiyah Ramajayam Institute of
Science and Technology (PRIST)
Thanjavur - 613 403.

day

DEAN
School of Arts & Science
Ponnaiyah Ramajayam Institute of
Science & Technology (PRIST)
Deemed to be University
Vallam, Thanjavur - 613 403.

ADD-ON COURSES
**Certificate in ANDROID AP
DEVELOPMENT**
PRIST
Deemed to be University, Vall.
Thanjavur -613 403

COURSE OBJECTIVE

The objective of Data visualization tools provide data visualization designers with an easier way to create visual representations of large data sets. When dealing with data sets that include hundreds of thousands or millions of data points, automating the process of creating a visualization, at least in part, makes a designer's job significantly easier..

The best data visualization tools on the market have a few things in common. First is their ease of use. The best tools also can output an array of different chart, graph, and map types. Most of the tools below can output both images and interactive graphs. There are exceptions to the variety of output criteria, though. Some data visualization tools focus on a specific type of chart or map and do it very well. Those tools also have a place among the "best" tools out there.

ELIGIBILITY CRITERIA

Any graduate shall be eligible for the admission to the course Intake Capacity 10 Seats on first cum first basis (Additional admission to the course is prerogative of the school)

COURSE DURATION (45 Hrs)

- Computer Studies
- Typographic Design
- Generic Skills
- Graphics Principle and Method of Design Introduction to Multimedia
- Basic Information
- Colour Theory for Computer Sound
- Principles Department of Computer Science
- Visual Communication of Arts and Science

HOD
Ponnaiyah Ramajayam Institute of Science and Technology (PRIST)
Thanjavur - 613 403

c) Attendance = 05
marks Total = 20 marks

Criteria for a pass in the subject
Minimum marks in theory - 45

SCHEME OF EXAMINATION:-

Duration of written examination - 3 hrs

Maximum marks - 100

CERTIFICATION

The candidates successfully qualifying the course shall be awarded a certificate to that effect in the appropriate form by School of Arts and Science, Department of Computer Science, PRIST University, Thanjavur, Vallam

COURSE OUTCOMES:

Design effective data visualizations in order to provide new insights into a communicate information to the viewer..

Find and select appropriate data that can be used in order to create a visualization that answers a particular question

Understand how Cultures of Practice influence the way data may be collected, described, or formatted in order to align their own data management practices with those of their discipline.

- Digital Publishing
- Principles of Management
- Drawing as Basis for
- Multimedia Authoring
- Flash & Scripting for the Web
- Web Campaign Implementation
- Animation the Production Process
- Management
- Language Career planning and guidance

EXAMINATION

1. Every student has to give periodic tests consisting of Programming tasks and Objective Questions
2. At the end of the Course each student will give a presentation on a topic covered in the course

COURSE STRUCTURE AND DURATION

Course is 6 month duration and will be of 45 hrs imparted training programme covering theoretical and practical aspects of Adobe Photoshop.

Eligibility criteria for appearing in the in the final examination

Minimum Attendance - 80%

Minimum Internal Assessment marks - 40%

- It will be done through the whole year.
- Candidate must obtain at least 35% marks in theory internal assessment to be eligible for the university examination.

Internal assessment will be done as follows:

- a) Mid-term and term examinations = 10 marks
- b) Assignments/Projects/Class test/Clinical Presentations = 05 marks

DEAN

School of Arts & Science
Ponnaiyah Ramajayam Institute of
Science & Technology (PRIST)
Deemed to be University
Vallam, Thanjavur - 613 403.

Full Name _____
 Programme _____
 Discipline _____
 Institution Name _____
 Date of Birth _____
 Gender (M/F) _____
 E-Mail Id _____
 Mobile No _____
 Permanent Address _____



**PONNAIYAH RAMAJAYAM INSTITUTE
 SCIENCE & TECHNOLOGY (PRIST)**

Deemed to be University
 01.09.2014



- Taking screen shots using selenium
- Understand Extent Reports
- Handling multiple windows, pop-ups, alerts
- Develop Various frameworks
- Freelancers that want to make bug free websites

ELIGIBILITY CRITERIA

Any graduate shall be eligible for the admission to the course on first come first basis (Additional admission to the course is prerogative of the school)



COURSE DURATION (45 Hrs)

Module 1: Selenium IDE

- Installing Selenium IDE
- Creating your First Selenium IDE script
- How to use Locators in Selenium IDE
- How to enhance a script using Selenium IDE
- Creating and Running Tests
- Creating and Running Test Suite

Module 2: WebDriver Introduction

- Introduction to WebDriver & Comparison with Selenium RC
- Installing Selenium WebDriver
- Architecture of selenium WebDriver
- Creating your First Script in Webdriver

Module 3: Page Object Model (POM) & Page Factory in Selenium

- What is POM
- Why POM?
- Advantages of POM
- Creating POM Tests
- What is Page Factory?

Signature of the Applicant

Submission of Application Form

Submit your Application form in person to the co-ordinator, School of Arts and Science, PRIST University, Thanjavur, Vallam, 613 403. Application may be send to

Course Co-Ordinator

The Head of the Department
 Department of Computer Science
 PRIST University, Thanjavur.
 E-mail: pristcsn@gmail.com

ADD-ON COURSES

Certificate in [Software Testing Using Selenium]

PRIST

Deemed to be University, Vallam,
 Thanjavur -613 403

COURSE OBJECTIVE

- Understand Selenium IDE
- Understand web elements
- Understand [Unit/TestNG] framework

HOD
 Department of Computer Science
 School of Arts and Science
 Ponnaiyah Ramajayam Institute of
 Science and Technology (PRIST)
 Thanjavur - 613 403.

DEAN
 School of Arts & Science
 Ponnaiyah Ramajayam Institute
 Science & Technology (PRIST)
 Deemed to be University
 Vallam, Thanjavur - 613 403.

- Creating Tests with Page Factory
- Module 4: Database Testing using Selenium
- JDBC (Java Database Connectivity)
 - Driver Manager
 - Driver
 - Connection
 - Statement
 - ResultSet
 - -SQLException
 - Connecting to Databases
 - Sending SQL Queries to Database
 - Processing Results
 - Real-time examples of Database Testing with Selenium

EXAMINATION

1. Every student has to give periodic tests consisting of Programming tasks and Objective Questions

2. At the end of the Course each student will give a presentation on a topic covered in the course

COURSE STRUCTURE AND DURATION

Course is 6 months duration and will be of 45 hrs imparted training programme covering theoretical and practical aspects of Adobe photoshop

Eligibility criteria for appearing in the final examination

Minimum Attendance - 50%

Minimum Internal Assessment marks - 40%

• It will be done through the whole year.

• Candidate must obtain at least 35% marks in theory internal assessment to be eligible for the university examination.

Internal assessment will be done as follows:

- Mid-term and term examinations = 10 marks
 - Assignments/Projects/Class test/Clinical Presentations = 05 marks
 - Attendance = 05 marks
- Total = 20 marks

Criteria for a pass in the subject
Minimum marks in theory - 45

SCHEME OF EXAMINATION -

Duration of written examination - 3 hrs
Maximum marks - 100

CERTIFICATION

The candidates successfully qualifying the course the course shall be awarded a certificate to that effect in the appropriate form by School of Arts and Science, Department of Computer Science, PRIST University, Thanjavur, Vallam.

COURSE OUTCOMES:

- Understanding Selenium tool to perform testing
- Writing test suits for applications
- Construct and test simple programs.
- Understanding the use of bug tracking and testing tool Bugzilla, Jira



HOD

Department of Computer Science
School of Arts and Science
Ponnaiyah Ramajayam Institute of
Science and Technology (PRIST),
Thanjavur - 613 403.

DEAN

School of Arts & Science
Ponnaiyah Ramajayam Institute of
Science & Technology (PRIST),
Deemed to be University
Vallam, Thanjavur - 613 403.

Full Name :
 Programme :
 Discipline :
 Institution Name:
 Date of Birth :
 Gender (M/F) :
 E. Mail Id :
 Mobile No :
 Permanent Address :



About the University
 Ponnaiyah Ramajayam Institute of Science and Technology (PRIST) is a deemed university in Vallam, India. The institute offers undergraduate and postgraduate courses in Engineering, Science, Education, Management, Arts, and Law, as well as research programmes.

Facilities Available

- Gain skills required to succeed in an entry-level IT job
- Learn to perform day-to-day IT support tasks including computer assembly, wireless networking, installing programs, and customer service
- Learn how to provide end-to-end customer support, ranging from identifying problems to troubleshooting and debugging
- Learn to use systems including Linux, Domain Name Systems, Command-Line Interface, and Binary Code

Signature of the Applicant

Submission of Application Form

Submit your Application form in person to the co-ordinator, School of Arts and Science, PRIST University, Thanjavur, Vallam, 613 403.
 Application may be send to
 Course Co-Ordinator

The Head of the Department
 Department of Computer Science
 PRIST University, Thanjavur.
 E.mail: pristcstn@prist.com

[Signature]
 HOD
 Department of Computer Science
 School of Arts and Science
 Ponnaiyah Ramajayam Institute of Science and Technology (PRIST)
 Thanjavur - 613 403.



Google IT Support
 Professional Certificate

ADD-ON COURSES
 Certificate in GOOGLE IT SUPPORT

PRIST
 Deemed to be University, Vallam
 Thanjavur -613 403

[Signature]
 DEAN
 School of Arts & Science
 Ponnaiyah Ramajayam Institute of Science and Technology (PRIST)
 Deemed to be University
 Thanjavur - 613 403

COURSE OBJECTIVE

The purpose of machine learning is to discover patterns in your data and then make predictions based on often complex findings to answer business questions, detect and analyse trends and help solve problems

The goal of google it support is to program computers to use example data or experience to solve a given problem.

To understand the basic theory underlying machine learning. To be able to formulate machine learning problems corresponding to different applications. To understand a range of machine learning algorithms along with their strengths and weaknesses.

ELIGIBILITY CRITERIA

Any graduate shall be eligible for the admission to the course Intake Capacity 15 Seats on first cum first basis (Additional admission to the course is prerogative of the school)

COURSE DURATION (45 Hrs)

- Computer Studies
- Typographic Design
- Generic Skills
- Graphics Principle and Method of Design Introduction to Multimedia
- Basic Information
- Web Campaign Implementation
- Animation the Production Process
- Sound Recording
- Breakdown: Voice
- Industrial Training HOD
- L. Department of Computer Science
- School of Arts and Science
- Ponnaiyah Ramajayam Institute of Science and Technology (PRIST) Thanjavur - 613 403.

L. Department of Computer Science
School of Arts and Science
Ponnaiyah Ramajayam Institute of Science and Technology (PRIST)
Thanjavur - 613 403.

- Language Career planning and guidance

EXAMINATION

1. Every student has to give periodic tests consisting of Programming tasks and Objective Questions
2. At the end of the Course each student will give a presentation on a topic covered in the course

COURSE STRUCTURE AND DURATION

Course is duration of 45 hrs imparted training programme covering theoretical and practical aspects of Adobe photoshop. Eligibility criteria for appearing in the in the final examination

Minimum Attendance - 80%

Minimum Internal Assessment marks - 40%

- It will be done through the whole year.
- Candidate must obtain at least 35% marks in theory internal assessment to be eligible for the university examination.

Internal assessment will be done as follows:

- a) Mid-term and term examinations = 10 marks
 - b) Assignments/Projects/Class test/Clinical Presentations = 05 marks
 - c) Attendance = 05 marks
- marks Total = 20 marks

Criteria for a pass in the subject

Minimum marks in theory - 45

SCHEME OF EXAMINATION:-

Duration of written examination - 3 hrs

Maximum marks - 100

CERTIFICATION

The candidates successfully qualifying the course the course shall be awarded a certificate to that effect in the appropriate form by School of Arts and Science, Department of Computer Science, PRIST University, Thanjavur, Vallam.

COURSE OUTCOMES

- Appreciate the importance of visualization in the data analytics solution
- Apply structured thinking to unstructured problems Understand a very broad collection of machine learning algorithms and problems
- Learn algorithmic topics of machine learning and mathematically deep enough to introduce the required theory Develop an appreciation for what is involved in learning from data.



DEAN
School of Arts & Science
Ponnaiyah Ramajayam Institute of Science & Technology (PRIST)
Deemed to be University
Vallam, Thanjavur - 613 403



About the University

Ponnaiyah Ramajayam Institute of Science and Technology (PRIST) is a deemed university in Vallam, India. The institute offers undergraduate and postgraduate courses in Engineering, Science, Education, Management, Arts, and Law, as well as research programmes.

Facilities Available

As the world becomes increasingly reliant on technology, the attack surface of cyberspace continues to expand. Cyberthreats have grown more sophisticated, posing significant risk to individuals, organizations and governments alike. It is imperative to examine the top cyberthreats faced by enterprises today and consider what preventive measures can be taken to safeguard digital assets and privacy.

Signature of the Applicant

Submission of Application Form

Submit your Application form in person to the co-ordinator, School of Arts and Science, PRIST University, Thanjavur, Vallam, 613 403.

Application may be send to

Course Co-Ordinator

The Head of the Department
Department of Computer Science
PRIST University, Thanjavur.

E-mail: pristcsn@pristmail.com

Department of Computer Science
School of Arts and Science
Ponnaiyah Ramejyam Institute of
Science and Technology (PRIST)
Thanjavur - 613 403.

DEAN

School of Arts & Science
Ponnaiyah Ramajayam Institute of
Science & Technology (PRIST)
Deemed to be University
Vallam, Thanjavur - 613 403.

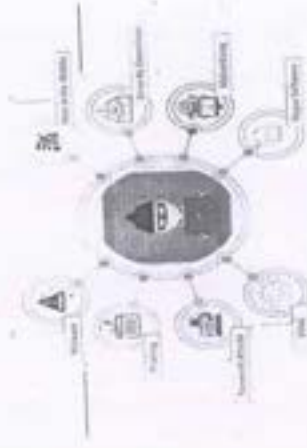

ADD-ON COURSES

Certificate in Introduction to Cyber Security and Cyber Attacks

PRIST

Deemed to be University, Vall-

Thanjavur -613 403

COURSE OBJECTIVE

The objective of Data visualization tools provide data visualization designers with an easier way to create visual representations of large data sets. When dealing with data sets that include hundreds of thousands or millions of data points, automating the process of creating a visualization, at least in part, makes a designer's job significantly easier..

The best data visualization tools on the market have a few things in common. First is their ease of use. The best tools also can output an array of different chart, graph, and map types. Most of the tools below can output both images and interactive graphs. There are exceptions to the variety of output criteria, though. Some data visualization tools focus on a specific type of chart or map and do it very well. Those tools also have a place among the "best" tools out there.

ELIGIBILITY CRITERIA

Any graduate shall be eligible for the admission to the course Intake Capacity 10 Seats on first cum first basis (Additional admission to the course is prerogative of the school)

COURSE DURATION (45 Hrs)

- Computer Studies
- Typographic Design
- Visual Communication
- Digital Publishing

HOD

Department of Computer Science
School of Arts and Science
Ponnaiyah Ramajayam Institute of
Science and Technology (PRIST)
Thanjavur - 613 403.

Principles of Management

- Design: Character
- Background & Concept
- Introduction to Computer Animation
- Web Design
- Digital Portfolio Development & Presentation
- Project-1 + Case Study 1
- Industrial Training
- Live Project
- Team Management
- Language Career planning and guidance

EXAMINATION

1. Every student has to give periodic tests consisting of Programming tasks and Objective Questions
2. At the end of the Course each student will give a presentation on a topic covered in the course

COURSE STRUCTURE AND DURATION

Course duration of 45 hrs imparted training programme covering theoretical and practical aspects of Adobe photoshop

Eligibility criteria for appearing in the in the final examination

- Minimum Attendance - 80%
- Minimum Internal Assessment marks - 40%
- It will be done through the whole year.
- Candidate must obtain at least 35% marks in the theory internal assessment to be eligible for the university examination.

Internal assessment will be done as follows:

- a) Mid-term and term examinations = 10 marks
 - b) Assignments/Projects/Class test/Clinical Presentations = 05 marks
 - c) Attendance = 05 marks
- Total = 20 marks

Criteria for a pass in the subject
Minimum marks in theory - 45

SCHEME OF EXAMINATION:-

Duration of written examination - 3 hrs
Maximum marks 100

CERTIFICATION

The candidates successfully qualifying the course shall be awarded a certificate to that effect in the appropriate form by School of Arts and Science, Department of Computer Science, PRIST University, Thanjavur, Valliam.

COURSE OUTCOMES:

After completion of this course, students will be able to – CS6-60.2.1 Understand the various tools and methods used in cybercrime. CS6-60.2.2 Identify risk management processes, risk treatment methods, organization of information security. CS6-60.2.3 Classify cyber security solutions and information assurance.

DEAN

School of Arts & Science
Ponnaiyah Ramajayam Institute of
Science & Technology (PRIST)
De 3.m.e.1 to be University
Valliam, Thanjavur - 613 403.

Full Name :
 Programme :
 Discipline :
 Institution Name:
 Date of Birth :
 Gender (M/F) :
 E. Mail Id :
 Mobile No :
 Permanent Address :



E.mail:
pristcstn1@gmail.com About the University

Ponnaiyah Ramajayam Institute of Science and Technology (PRIST) is a deemed university in Vallam, India. The institute offers undergraduate and postgraduate courses in Engineering, Science, Education, Management, Arts, and Law, as well as research programmes.

Signature of the Applicant

Submission of Application Form
 Submit your Application form in person to the co-ordinator, School of Arts and Science, PRIST University, Thanjavur, Vallam, 613 403.
 Application may be send to
 Course Co-Ordinator

The Head of the Department
 Department of Computer Science
 PRIST University, Thanjavur.

HOD
 Department of Computer Science
 School of Arts and Science
 Ponnaiyah Ramajayam Institute of Science and Technology (PRIST)
 Thanjavur - 613-403.



**PONNAIYAH RAMAJAYAM INSTITU
 SCIENCE & TECHNOLOGY (PRIST)**
 Declared as DEEMED TO BE UNIVERSITY
 U.S. 3 of USC Act, 1956



Facilities Available

The research group has initiated following activities:

- Decentralised Software Architecture
- Technological Deep-Dive of Blockchain Technologies
- Developing Whitepapers, Concept Notes and Process Guidance

**ADD-ON COURSES
 CERTIFICATE COURSE ON BLOCK CH**

**PRIST Deemed to be Univers
 Vallam,
 Thanjavur -613 403**

DEAN
 School of Arts & Science
 Ponnaiyah Ramajayam Institute of Science & Technology (PRIST)
 Deamed to be University
 Vallam, Thanjavur - 613 403.

COURSE OBJECTIVE

Impart strong technical understanding of Blockchain technologies
Develop familiarity of current technologies, tools, and implementation strategies
Introduce application areas, current practices, and research activity

ELIGIBILITY CRITERIA

Any graduate shall be eligible for the admission to the course Intake Capacity 15 Seats on first cum first basis (Additional admission to the course is prerogative of the school)

COURSE DURATION (45 Hrs)

- Blockchain Introduction
- Distributed Ledger
- Security and Privacy
- Blockchain Salient Features
- Blockchain Technology Landscape
- Introduction to Hyperledger
- Hyperledger Fabric - Part 1
- Hyperledger Fabric - Part 2
- Hyperledger Fabric - Part 3
- Hyperledger Composer - Part 1
- Hyperledger Composer - Part 2
- Business Application Modeling
- Introduction to Ethereum
- Ethereum Smart Contracts
- Smart Contract with Solidity 1
- Smart Contract with Solidity 2
- Dapps
- Mining storage
- Alternative Technologies
- Blockchain and Science

HOD

Deployment of Computer Science
School of Arts and Science
Thiruvananthapuram Institute of
Technology (PRIST)
Thanjavur - 613 403.

- Blockchain and AI
- Blockchain and Enterprise Integration
- Blockchain in Healthcare
- Blockchain in Supply Chain

EXAMINATION

1. Every student has to give periodic tests consisting of Programming tasks and Objective Questions
2. At the end of the Course each student will give a presentation on a topic covered in the course

COURSE STRUCTURE AND DURATION

Course is 3 months duration and will be of 45 hrs imparted training programme covering theoretical and practical aspects of Adope photoshop.

Eligibility criteria for appearing in the in the final examination

- Minimum Attendance - 80%
- Minimum Internal Assessment marks - 40%
- It will be done through the whole year.
- Candidate must obtain at least 35% marks in theory internal assessment to be eligible for the university examination.

Internal assessment will be done as follows:

- a) Mid-term and term examinations = 10 marks
 - b) Assignments/Projects/Class test/Clinical Presentations = 05 marks
 - c) Attendance = 05 marks
- marks Total = 20 marks

Criteria for a pass in the subject
Minimum marks in theory - 45

SCHEME OF EXAMINATION:-

Duration of written examination - 3 hrs
Maximum marks - 100

CERTIFICATION

The candidates successfully qualifying the course shall be awarded a certificate to that effect in the appropriate form by School of Arts and Science, Department of Computer Science, PRIST University, Thanjavur, Vallam.

COURSE OUTCOMES:

- CO1: Understand and explore the working of Blockchain technology (Understanding)
- CO2: Analyze the working of Smart Contracts (Analyze)
- CO3: Understand and analyze the working of Hyperledger (Analyze).
- CO4: Apply the learning of solidity to build de-centralized apps on Ethereum (Apply)
- CO5: Develop applications on Blockchain

DEAN

School of Arts & Science
Thiruvananthapuram Institute of
Science & Technology (PRIST)
Deemed to be University
Vallam, Thanjavur - 613 403.



**PONNAYAH RAMAJAYAM INSTITUTE
SCIENCE & TECHNOLOGY (PRIST)**

Deemed as UNIVERSITY
By U.O No. 109, 1998



Full Name _____

Programme _____

Discipline _____

Institution Name _____

Date of Birth _____

Gender (M/F) _____

E-Mail Id _____

Mobile No _____

Permanent Address _____

Signature of the Applicant

Submission of Application Form

Submit your Application form in person to the co-ordinator, School of Arts and Science, PRIST University, Thanjavur, Vallam, 613 403. Application may be send to

Course Co-Ordinator

The Head of the Department
Department of Computer Science
PRIST University, Thanjavur
E.mail: pristcstnija@gmail.com



ADD-ON COURSES

**Diploma course on
R/Weka Tool**

PRIST

**Deemed to be University, Vallam,
Thanjavur -613 403**

COURSE OBJECTIVE

The objective of this course is to learn the basic concepts of Big Data including various methods for analysis of data

ELIGIBILITY CRITERIA

Any graduate shall be eligible for the admission to the course on first cum first basis (Additional admission to the course is prerogative of the school)

COURSE DURATION (90HRS)

Module 1

Essential of R programming

- Introduction To The R Language
- Programming Statistical Graphics
- Programming With R

Module 2

Data manipulation and mining techniques

- Data In R
- Reading And Writing Data
- R And Databases
- Dates
- Factors
- Subsetting
- Character Manipulation
- Data Aggregation

Module 3

Statistical applications using R programming

- Probability And Distributions
- Descriptive Statistics And Graphics
- One- And Two-Sample Tests
- Regression And Correlation
- Types of Digital Data
- Introduction to Big Data
- Big Data Analytics
- History of WEKA
- Analysing Data with WEKA

HOD
Department of Computer Science
School of Arts and Science
Ponnaiyah Ramajayam Institute of
Science and Technology (PRIST)
Thanjavur - 613 403.

DEAN
School of Arts & Science
Ponnaiyah Ramajayam Institute of
Science & Technology (PRIST)
Deemed to be University
Vallam, Thanjavur - 613 403.

Module 4

- Introduction to Big data tools like Hadoop
- Map reduce and HDFS

Module 5

- Recommendation system
- Big Data Analysis through R

EXAMINATION

1. Every student has to give periodic tests consisting of Programming tasks and Objective Questions

2. At the end of the Course each student will give a presentation on a topic covered in the course

COURSE STRUCTURE AND DURATION

Course is 6 months duration and will be of 45 hrs updated training programme covering theoretical and practical aspects of Adobe photoshop.

Eligibility criteria for appearing in the in the final examination

Minimum Attendance - 80%

Minimum Internal Assessment marks - 40%

- It will be done through the whole year.
- Candidate must obtain at least 35% marks in theory internal assessment to be eligible for the university examination.

Internal assessment will be done as follows:

- a) Mid-term and term examinations = 10 marks
 - b) Assignments Projects Class test Clinical Presentations = 05 marks
 - c) Attendance = 05 marks
- Total = 20 marks

Criteria for a pass in the subject
Minimum marks in theory - 45

SCHEME OF EXAMINATION:-

Duration of written examination - 3 hrs
Maximum marks - 100

CERTIFICATION

The candidates successfully qualifying the course the course shall be awarded a certificate to that effect in the appropriate form by School of Arts and Science, Department of Computer Science, PRIST University, Thanjavur, Vallam.

COURSE OUTCOMES:

- Visually represent analysis's conclusions to technical and non-technical audiences
- Use the most common algorithms, to make sense of large amounts of data, which are applicable to most business and management problems.
- Learn WEKA and apply machine learning techniques using R.



HOD

Department of Computer Science
School of Arts and Science
Ponnalyah Ramajayam Institute of
Science and Technology (PRIST)
Thanjavur - 613 403.

DEAN

School of Arts & Science
Ponnalyah Ramajayam Institute of
Science & Technology (PRIST)
Deemed to be University
Vallam, Thanjavur - 613 403.

Full Name _____
 Programme _____
 Discipline _____
 Institution Name _____
 Date of Birth _____
 Gender (M/F) _____
 E-Mail Id _____
 Mobile No _____
 Permanent Address : _____



**PONNAIYAH RAMAJAYAM INSTITUTE
 SCIENCE & TECHNOLOGY (PRIST)**
 Deemed to be University
 No. 1, 1057 Ave., Vallam

About the University
 Ponnaiyah Ramajayam Institute of Science and Technology (PRIST) is a deemed university in Vallam, India. The institute offers undergraduate and postgraduate courses in Engineering, Science, Education, Management, Arts, and Law, as well as research programmes.



Signature of the Applicant _____

Facilities Available
 The Department of Computing has highly sophisticated computing facilities for training and R&D work in various areas of Computer Science & Information Technology applications. The facilities available include Parallel Programming, Software Engineering & Testing, Computer Graphics, Multimedia & 3D, AutoCAD, Image Processing, Networking, Various Operating Systems, GUI, Distributed Computing, DoTnet. The Department of Computing has signed Memoranda with IBM for Python, IoT, Machine Learning, Artificial intelligent and Big data Analytics training.

**ADD-ON COURSES
 DIPLOMA IN WEB
 APPLICATION
 DEVELOPMENT AND
 HOSTING**

PRIST
 Deemed to be University, Vallam,
 Thanjavur -613 403

Submission of Application Form
 Submit your Application form in person to the co-ordinator, School of Arts and Science, PRIST University, Thanjavur, Vallam, 613 403. Application may be send to
 Course Co-Ordinator
 Prof. Gayatri G
 Assistant Professor
 Department of Computer Science
 PRIST University, Thanjavur
 E-mail: pristcstn@gmail.com

Prof. Gayatri G

HOD
 Department of Computer Science
 School of Arts and Science
 Ponnaiyah Ramajayam Institute of
 Science and Technology (PRIST)
 Thanjavur - 613 403.

Dr. S. S. S.

DEAN
 School of Arts & Science
 Ponnaiyah Ramajayam Institute of
 Science & Technology (PRIST)
 Deemed to be University
 Vallam, Thanjavur - 613 403.

COURSE OBJECTIVE

Specialization track involving Web Application Architectures. This course will give you the basic background terminology and fundamental concepts that you need to understand in order to build modern full stack web applications. A full stack web developer is familiar with each "layer" of the software technologies involved in a web application, including data modeling and database technologies, the web server environment and middleware components, network protocols, the user interface and basic visual design and user interaction concepts.

ELIGIBILITY CRITERIA

Any graduate shall be eligible for the admission to the course intake Capacity 15 Seats on first cum first basis (Additional admission to the course is prerogative of the school)

COURSE DURATION (90 Hrs)

Module #1 - Web Applications in Context

This module sets the context for what we will study in this specialization by first providing a historical perspective on computing and web applications. Next we provide an overview of how the Internet works, and then we discuss how web applications have evolved over the past few decades. After that we'll discuss some of the elements of modern software practice, including the typical tools that software engineers now use and the agile development practices they follow. The notion of software design patterns will be introduced, and the n-tier architecture design pattern,

fundamental to modern web application design, is then presented. We will also discuss a few current topics related to web application development. Finally, we will show you how to set up the software development environment you will use throughout the remainder of the courses in this

Module #2 - Web Applications Frameworks

In this module you will learn about web application frameworks. We will start by talking about the evolution of software and programming languages, and then talk about software application frameworks. The fundamental trade-off we will consider is programmer productivity versus program efficiency. Next you will learn about web application frameworks, as well as the model-view-controller design pattern that is the backbone for many of these frameworks. We will also consider how these frameworks support the agile programming principles associated with modern software practice. This will include a discussion of distributed version control systems and you will learn how to use the popular Git system. We will also demonstrate how to use Git with a Ruby on Rails application. We will use Git to submit all of the programming applications in this specialization.

Module #3 - Managing Data

A successful web application provides information to users that is (1) useful, and also (2) easy to access and understand. This information is often collected from users, as well as from other information sources, and must be stored in a manner that allows it to be manipulated by the web application. The typical approach is to store this data in a relational database. In this module you will

learn some basic concepts associated with modeling the data in a web application, including how to specify the relationships between various data entities. We will also investigate how to hook a web application up to a back-end data store, along with good design techniques that will make it easier to use the data in your web applications by maintaining consistency throughout the entire web stack.

Module #4 - Middleware

Middleware is an abstraction layer that hides details about hardware devices and other lower-level software services from an application. Middleware services implement common low-level functions, such as communication with the operating system, application servers, database servers, etc., so that application developers do not need to concern themselves with these details, and can instead focus on the application functionality they are trying to provide. In a web application, these services generally make use of the HTTP protocol, and in a web application framework, the MVC design pattern can be thought of as being implemented over the middleware.

Module #5 - The User Interface

In our final module we will discuss the User Interface. We will touch on CSS and JavaScript, and how these are used to add style to layout and design of HTML documents. We will also learn about Ajax and how it improves user requests.

HOD
Department of Computer Science
School of Arts and Science
Ponnalyah Ramajayam Institute of
Science and Technology (PRIST)
Thanjavur - 613 403.

DEAN
School of Arts & Science
Ponnalyah Ramajayam Institute of
Science & Technology (PRIST)
Deemed to be University
Vallam, Thanjavur - 613 403.

Full Name :

Programme :

Discipline :

Institution Name:

Date of Birth :

Gender (M/F) :

E. Mail Id :

Mobile No :

Permanent Address :

.....

.....

.....



**PONNAIYAH RAMAJAYAM INST
SCIENCE & TECHNOLOGY (PRIS**
Declared as DEEMED TO BE UNIVERSITY
Ex-3 of UGC Act, 1956



About the University

Ponnaiyah Ramajayam Institute of Science and Technology (PRIST) is a deemed university in Vallam, India. The institute offers undergraduate and postgraduate courses in Engineering, Science, Education, Management, Arts, and Law, as well as research programmes.

Facilities Available

The Department of Computing has highly sophisticated computing facilities for training and R&D work in various areas of Computer Science & Information Technology applications. The facilities available include Parallel Programming, Artificial Intelligence (AI) and Machine Learning (ML). The Department of Computing has signed Memoranda with IBM for Python, IoT, Machine Learning, Artificial intelligent and Big data Analytics training.

Signature of the Applicant

Submission of Application Form

Submit your Application form in person to the co-ordinator, School of Arts and Science, PRIST University, Thanjavur, Vallam, 613 403.
Application may be send to

Course Co-Ordinator

The Head of the Department
Department of Computer Science
PRIST University, Thanjavur.

HOD
Department of Computer Science
School of Arts and Science
Ponnaiyah Ramajayam Institute of
Science and Technology (PRIST)
Thanjavur - 613 403.

Signature of HOD

**PRIST Deemed to be Univer:
Vallam, Thanjavur -613 40**

**ADD-ON COURSES
DIPLOMA IN AI AND ML US
PYTORCH**

Signature of Dean

DEAN
School of Arts & Science
Ponnaiyah Ramajayam Institute of
Science & Technology (PRIST)
Deemed to be University
Vallam, Thanjavur - 613 403.

Course Outcomes

Master PyTorch workflow from data preparation to model fitting, evaluation, and deployment.

Implement neural network classification in PyTorch, handling non-linearity and multi-class scenarios.

Apply computer vision techniques with custom datasets, including model evaluation and transfer learning.



DEAN
 School of Arts & Science
 Ponnaiyah Ramajayam Institute of
 Science & Technology (PRIST)
 Deemed to be University
 Vellore, Thanjavur - 613 463.

Eligibility criteria for appearing in the in the final examination

Minimum Attendance - 80%

Minimum Internal Assessment marks - 40%

- It will be done through the whole year.
- Candidate must obtain at least 35% marks in theory internal assessment to be eligible for the university examination.

Internal assessment will be done as follows:

- a) Mid-term and term examinations = 10 marks
 - b) Assignments/Projects/Class test/Clinical Presentations = 05 marks
 - c) Attendance = 05 marks
- Total = 20 marks

Criteria for a pass in the subject
 Minimum marks in theory - 45

SCHEME OF EXAMINATION:-

Duration of written examination - 3 hrs
 Maximum marks – 100

CERTIFICATION

The candidates successfully qualifying the course shall be awarded a certificate to that effect in the appropriate form by School of Arts and Science, Department of Computer Science.



Department of Computer Science
 School of Arts and Science
 Ponnaiyah Ramajayam Institute of
 Science and Technology (PRIST)
 Thanjavur - 613 403.

COURSE OBJECTIVE

- This course will enable student understand the fundamental logic. Students will be able to infer the concept Logic and inference.

ELIGIBILITY CRITERIA

Any graduate shall be eligible for the admission to the course Intake Capacity 15 Seats on first cum first basis (Additional admission to the course is prerogative of the school)

COURSE DURATION (90 Hrs)

1. Introduction to Artificial Intelligence (AI) and Machine Learning (ML)
2. Fundamentals of Pytorch
3. Supervised Learning with Pytorch
4. Unsupervised Learning with Pytorch
5. Deep Learning with Pytorch

EXAMINATION

1. Every student has to give periodic tests consisting of Programming tasks and Objective Questions
2. At the end of the Course each student will give a presentation on a topic covered in the course

COURSE STRUCTURE AND DURATION

Course is 6 month duration and will be of

90 hrs imparted training programme covering theoretical and practical aspects of Artificial Intelligence (AI) and Machine Learning (ML)

Academic year: 2023-2024
Course: Designing [Photoshop, Premium, Illustrator]
Subject Code: 22CC01

Aim:

To learn the image creation, graphic design and photo editing software developed by Adobe

Objectives:

- Navigate the Photoshop interface.
- Perform basic photo retouching tasks.
- Understand how to work with layers.
- Use effects and filters.
- Combine two separate images into one.
- Understand image resolution and file output for print and web graphics.

UNIT-1

Getting Started, Photo Retouching , Cropping Photos

Creating Graphics: Combing Photos, Text, & Graphics

UNIT-2

Replacing Backgrounds - Blend Modes & Opacity

Color Correction Using Color Balance - Color Correction Using Curves

Preparing Digital Photos for Print - Exporting Files for Web/ Digital

UNIT-3

Sharpening Photos – The Liquify Filter & Intro to Smart Filters

Layer Masking – Masking Smart Filters

UNIT-4

Converting to Black & White & Lens Correction

Placing Your Designs in Pre-made Mockups

Adjustment Layers & Masks - Retouching

UNIT-5

Changing Color With a Blending Mode, Clipping Masks: Filling Shapes with Images

Using Adjustment Layers as Clipping Masks

Camera Raw Fundamentals , Camera Raw as a Filter

REFERENCE:

Adobe Photoshop CS6 on Demand

Adobe Photoshop 7.0 Classroom in a Book



HOD
Department of Computer Science
School of Arts and Science
Ponnalyah Ramajayam Institute of
Science and Technology (PRIST)
Thanjavur - 613 403.



DEAN
School of Arts & Science
Ponnalyah Ramajayam Institute of
Science & Technology (PRIST)
Deemed to be University
Vellam, Thanjavur - 613 403.

Course: WEB APPLICATION DEVELOPMENT AND HOSTING
Subject Code: 22CC02

Aim:

- To learn the basics of web application and development of hosting.

Course objective:

- To know the fundamental concepts of web designing
- To learn fundamental web application using in hosting
- To study various analytics on stream data.

MODULE -1

Basics of Web Designing
Multimedia and its Applications
Web Technologies
Introduction to Web Design & Applications
Computer Graphics

MODULE -2

Mathematical Structure for Computer Science
HTML
CSS
JavaScript
Bootstrap

MODULE -3

Adobe Dreamweaver
Adobe Flash
Available Softwares for Graphic Designing
Animation Techniques

MODULE -4

Web Hosting Basics
Types of Hosting Packages
Registering domains
Defining Name Servers

MODULE -5

Using Control Panel
Creating Emails in Cpanel
Using FTP Client
Maintaining a Website

Course Outcomes:

- Convert real world problems to web accessing in online .
- Perform animation and tracking the packet hosting .
- Design efficient modeling of huge data and work in big data platforms.

REFERENCE:

1. Castro, Elizabeth and Hyslop . *HTML5, and CSS, Eight Edition: (Visual QuickStart Guide)*, Peachpit Press, 2013.
2. Devlin, Ian. *HTML5 Multimedia: Develop and Design*, Peachpit Press, 2011.



HOD

Department of Computer Science
School of Arts and Science
Ponnalyah Ramajayam Institute of
Science and Technology (PRIST)
Thanjavur - 613 403.



DEAN

School of Arts & Science
Ponnalyah Ramajayam Institute of
Science & Technology (PRIST)
Deemed to be University
Vallam, Thanjavur - 613 403.

COURSE: ANDROID APP DEVELOPMENT
Subject Code: 22CC03

Module 1: Fundamentals Of Android

- 1) OOPS Concept
- 2) SQL queries
- 3) Basics of Designing
- 4) Android Basics
 - Installing Android Studio
 - Creating an Android app project
 - Deploying the app to an emulator and a device
- 5) PHP and HTML basics

Module 2: Learning the Language(Java)

1. Classes and Object
2. Encapsulation
3. Constructors
4. Inheritance
5. Method Overriding
6. Polymorphism
7. Abstract method and classes
8. Interface and Packages
9. Exception Handling
10. Multitasking and Multithreading
11. Synchronization

Module 3: Android OS

1. Activities and Intents
2. Activity Lifecycle and Saving State
3. Activities and Implicit Intents
4. Debugging Your App
5. Testing Your App
6. User Input Controls
7. Menus

Module 4:

1. Screen Navigation
2. RecyclerView
3. Delightful User Experience
 - a. Drawable, Themes and Styles
 - b. Material design
 - c. Supporting landscape, multiple screen sizes
4. AsyncTask and AsyncTaskLoader
5. Broadcast receivers
6. Notifications
7. Transferring data efficiently

Module 5: Database connectivity

1. SQLite Data Types
2. Adding, Updating and Deleting Content using SQLite Database
3. Working with MySQL



HOD
Department of Computer Science
School of Arts and Science
Ponnaiyah Ramalingam Institute of
Science and Technology (PRIST)
Thanjavur - 613 403.



DEAN
School of Arts & Science
Ponnaiyah Ramalingam Institute of
Science & Technology (PRIST)
Deemed to be University
Vellam, Thanjavur - 613 403.

Course: Software Testing using Selenium
Subject Code: 22CC04

Aim:

- To learn the basics of software testing using java environment.

Course objective:

- To know the fundamental concepts of software testing
- To learn fundamental testing the application using selenium
- To study various inspect Web/HTML Elements

Module I: Java Programming for Selenium

1. Java Environment Setup

Download & Install Java (JDK) software, set Java environment variable path, and Download & Install Eclipse IDE.

2. Java Keywords and Identifiers

Java keywords are also known as reserved words. Keywords are particular words that act as a key to a code.

Identifiers in Java are symbolic names used for identification. They can be a class name, variable name, method name, package name, constant name, and more.

3. Java Program Structure

Java Program Structure, Java Syntax, Java Keywords & Literals, Java main method, Create Java Variables, Methods, conditions, loops, and IO.

4. Java Data Types

Java Data Types, Categories of Data Types in Java, Java Primitive Data Types, Java Non-primitive Data Types, and Data Type Conversion in Java.

9. Java Variables

Java Variables, What is Variable, Types of Variables in Java, Declare Variables, Assign values to Variables, and Java Variable Naming Rules.

10. Java Operators

Operators in Java, what is the operator? operator precedence, arithmetic operators, unary operators, comparison operators, and logical operators.

11. Java Control Flow

i. Decision Making/Conditional Statements

HOD
Department of Computer Science
School of Arts and Science
Ponniyeh Ramajayam Institute of
Science and Technology (PRIST)
Thanjavur - 613 403

DEAN
School of Arts & Science
Ponniyeh Ramajayam Institute of
Science & Technology (PRIST)
Deemed to be University
Vallur, Thanjavur - 613 403.

- ii. Loop Statements
- iii. Branching Statements

12. String Handling in Java

Java Strings, What is String?, Declare Strings in Java, String handling in Java, String Methods, String Concatenation, and String Comparison.

13. Java Data Structures

Java Arrays

Arrays in Java, What is Array in Java, Declare Arrays, Java Array built-in methods, advantages of Java Arrays, and Drawbacks of Java Arrays.

Java ArrayList

Java ArrayList, Java Data Structures, Java Arrays vs. ArrayList, Add elements to an ArrayList, Remove Java Array List Elements, and Java ArrayList Operations.

14. Java Input and Output

Java Input and Output, Java User Input, Java Output, Java Scanner Class, Java System Class, Java File Handling, and Java Database Connectivity.

15. Java Methods

Java User-defined methods

Java User-defined Methods, What is a Method?. Advantages of methods in Java. Declare & call methods, and Static & Non-static Methods in Java.

Java built-in methods

Java Built-in Methods, Java Java Standard Library Methods, Java String Methods, Java Number Methods, Java Character Methods, and Array Methods.

16. Java Exception Handling

Exception Handling in Java, What is Exception handling, Types of exceptions in Java, Java Program Runtime Errors, and Java try-catch block.

17. Java Object-Oriented Programming

Java Object-Oriented Programming, Class, Object, Method, Java Inheritance, Polymorphism in Java, Java Abstraction, and Java Encapsulation.

Module 2: Selenium Web Driver

1. Selenium Test Environment Setup

HOD
Department of Computer Science
School of Arts and Science
Ponnalyah Ramajayam Institute of
Science and Technology (PRIST)
Thanjavur - 613 403.

DEAN
School of Arts & Science
Ponnalyah Ramajayam Institute of
Science & Technology (PRIST)
Deemed to be University
Valr:n, Thanjavur - 613 403.

2. Inspect Web/HTML Elements
3. Locating Elements in Selenium (Using Element Locators)
4. Performing Actions on Elements (Using Selenium WebDriver Methods)
5. Selenium Page Object Model (Creating Object Repositories)
6. Writing Selenium Test Cases
Write Selenium Test Steps
Synchronization
Inserting Verification Points
Handling Run-time Errors
Etc.

Module 3: TestNG Testing Framework for Selenium

Install TestNG plug-in for Eclipse IDE, Create Test Batches (TestNG Programs), Prioritize Test Cases, Grouping Test Cases, Executing Test Batches, Generating Test Reports etc,

Course Outcomes:

- Convert real world problems to testing the software in online.
- Perform the test cases using various inspect web and HTML elements.
- Design efficient application using selenium and generate the test report.

REFERENCE:

1. Guide to test automation using selenium by Garg and Aditya, McGraw Hill.
2. Software Testing by Naresh Chanuhan, Oxford
2. <https://www.selenium.dev/Selenium WebDriver>

HOD
Department of Computer Science
School of Arts and Science
Ponnalyah Ramajayam Institute of
Science and Technology (PRIST)
Thanjavur - 613 403.

DEAN
School of Arts & Science
Ponnalyah Ramajayam Institute of
Science & Technology (PRIST)
Deemed to be University
Vallam, Thanjavur - 613 403.

Course: Google IT Support
Subject Code: 22CC05

Aim:

- To learn the basics of Google IT Support.

Course objective:

- To know the fundamental concepts of Google IT Support
- To study various analytics on stream data.

Unit 1:

Technical Support Fundamentals- Offered by Google. This course is the first of a series that aims to prepare you for a role as an entry-level IT Support Specialist.

Unit 2:

The Bits and Bytes of Computer Networking- Offered by Google. This course is designed to provide a full overview of computer networking. We'll cover everything from the fundamentals.

Unit 3:

Operating Systems and You: Becoming a Power User- Offered by Google. In this course -- through a combination of video lectures, demonstrations, and hands-on practice

Unit 4:

System Administration and IT Infrastructure Services- Offered by Google. This course will transition you from working on a single computer to an entire fleet. Systems administration is the field.

Unit 5:

IT Security: Defense against the digital dark arts- Offered by Google. This course covers a wide variety of IT security concepts, tools, and best practices. It introduces threats and attacks.

REFERENCE BOOKS

The IT Support Handbook- A How-To Guide to Providing Effective Help and Support to IT Users



HOD

Department of Computer Science
School of Arts and Science
Ponnaiyah Ramajayam Institute of
Science and Technology (PRIST)
Thanjavur - 613 403.



DEAN

School of Arts & Science
Ponnaiyah Ramajayam Institute of
Science & Technology (PRIST)
Deemed to be University
Vellam, Thanjavur - 613 403.

Course: Introduction to Cyber Security Tools and Cyber Attacks
Subject Code: 22CC06

Aim:

- To learnt the basics of Introduction to Cyber Security Tools and Cyber Attacks.

Course objective:

- To know the fundamental concepts of Introduction to Cyber Security Tools and Cyber Attacks
- To study various analytics on stream data.

UNIT-1

- Introduction to cyber security • Cybercrime and different modes of attacks • Intrusion detection system

UNIT-2

- It assets and wireless security • Cyber security assurance framework • Desktop security and malware

UNIT-3

- E-commerce and web-application security • Social engineering • Cyber security risk management

UNIT-4

- Cyber attacks, types of attacks motivation • Asset, threat and risk management • Oraganization security & frameworks • Information security governance • Security controls • Security control design • Software development life cycle (sdlc)

UNIT-5

- Authentication and password security • Wireless security • Investigation and digital forensic • Introduction to cryptography

REFERENCE BOOKS

Introduction to Cyber-Warfare A Multidisciplinary Approach

By Paulo Shakarian, Jana Shakarian, Andrew Ruef · 2013



HOD

Department of Computer Science
School of Arts and Science
Ponnalyah Ramajayam Institute of
Science and Technology (PRIST)
Thanjavur - 613 403.



DEAN

School of Arts & Science
Ponnalyah Ramajayam Institute of
Science & Technology (PRIST)
Deemed to be University
Vallem, Thanjavur - 613 403.

COURSE: Certificate course on Block Chain Technology
SUBJECT CODE: 23CC01

Aim:

To learn the basics of Block Chain technology

Objectives:

The block chain technology course allows the students to explore the driving force behind the cryptocurrency Bitcoin. Along with the Decentralization, Cryptography, Bitcoins with its alternative coins, Smart contracts and outside of currencies.

Unit -I

What is Block chain, Block chain Technology Mechanisms & Networks, Block chain Origins, Objective of Block chain, Block chain Challenges, Transactions And Blocks

Unit-II

P2P Systems, Keys As Identity, Digital Signatures, Hashing, and public key cryptosystems, private vs. public Blockchain. CAP theorem and block chain, Block chain Network, Mining Mechanism,

Unit-III

Distributed Consensus, Merkle Patricia Tree, Gas Limit, Transactions and Fee, Anonymity, Reward, Chain Policy, Life of Block chain application, Soft & Hard Fork, Private and Public block chain.

Benefits and limitations of block chain.

Unit-IV

Nakamoto consensus, Proof of Work, Proof of Stake, Proof of Burn, Difficulty Level, Sybil Attack, Energy utilization and alternate.

Unit-V

Decentralization Decentralization using block chain, Methods of decentralization, Routes to decentralization, Decentralized organizations.

Course outcomes:

At the end of the course the student will be able to:

1. Understand the types, benefits and limitation of block chain.
2. Explore the block chain decentralization and cryptography concepts.
3. Enumerate the Bitcoin features and its alternative options.
4. Describe and deploy the smart contracts
5. Summarize the block chain features outside of currencies

Textbook/ Textbooks: Mastering Block chain - Distributed ledgers, decentralization and smart contracts explained, Author- Imran Bashir, Packt Publishing Ltd, Second Edition, ISBN 978-1-78712-544-5, 2017 Reference Books

Blockchain Basics: A Non-Technical Introduction in 25 Steps, Author- Daniel Drescher, Apress, First Edition, 2017.

HOD
Department of Computer Science
School of Arts and Science
Ponnaiyah Ramajayam Institute of
Science and Technology (PRIST)
Thanjavur - 613 403.

DEAN
School of Arts & Science
Ponnaiyah Ramajayam Institute of
Science & Technology (PRIST)
Deemed to be University
Vallam, Thanjavur - 613 403.

Course: Diploma course on R / WEKA TOOL
Subject Code: 22DIP01

Aim:

- To learn the basics of data analysis in R / Weka Tool.

Objectives:

- To know the fundamental concepts of data handling and analytics
- To learn fundamental data analysis using in R
- To study various analytics on stream data.

MODULE -1

History and overview of R ,Install and configuration of R programming environment ,Basic language elements and data structures ,R+ Knitr+ Markdown+ GitHub ,Data input/output

MODULE -2

Data storage formats , Sub-setting objects , Vectorization, Control structures

MODULE -3

Functions ,Scoping Rules ,Loop functions ,Graphics and visualization ,Grammar of data manipulation (dplyr and related tools),Debugging/profiling , Statistical simulation

MODULE -4

Installation, Launching Explorer, Loading Data, File Formats

MODULE -5

Pre-processing the Data, Classifiers, Clustering, Association, Feature Selection

Course Outcomes:

- Convert real world problems to hypothesis and perform statistical analysis.
- Perform data analysis using in R.
- Design efficient modeling of huge data and work in big data platforms.

REFERENCE BOOKS

1. A First Course in Statistical Programming with R. W Braun.
2. Beyond Spreadsheets with R.
3. Data Mining: Practical Machine Learning Tools and Techniques
4. Programming Collective Intelligence
5. <http://www.cs.waikato.ac.nz>



HOD

Department of Computer Science
School of Arts and Science
Ponnalyah Ramajayam Institute of
Science and Technology (PRIST)
Thanjavur - 613 403.



DEAN

School of Arts & Science
Ponnalyah Ramajayam Institute of
Science & Technology (PRIST)
Deemed to be University
Vallem, Thanjavur - 613 403.

Course: Diploma course on Web Designing & Hosting
Subject Code: 22DIP02

Aim:

To learn the basics of Web Designing & Hosting

Objectives:

- Increase sales/conversions.
- Become a subject matter expert.
- Improve customer interactions.
- Build a brand image/reputation.

Syllabus:

- Basics of Web Designing
- Multimedia and its Applications
- Web Technologies
- Introduction to Web Design & Applications
- Computer Graphics
- Mathematical Structure for Computer Science
- HTML
- CSS
- JavaScript
- Bootstrap
- Adobe Dreamweaver
- Adobe Flash
- Available Softwares for Graphic Designing
- Animation Techniques

REFERENCE BOOKS

1. Website Designing -A Comprehensive Guide on Creating a Website from Basics
By John M Sterling · 2023

2. The Website Manager's Handbook
By Shane Diffily · 2006



HOD

Department of Computer Science
School of Arts and Science
Ponnalyah Ramajayam Institute of
Science and Technology (PRIST)
Thanjavur - 613 403.



DEAN

School of Arts & Science
Ponnalyah Ramajayam Institute of
Science & Technology (PRIST)
Deemed to be University
Valluvar, Thanjavur - 613 403.

Course: Diploma course on AI and ML using pytorch
Subject Code: 23DIP01

Aim:

To learnt the basics of AI and ML using pytorch

Objectives:

Mastering PyTorch: Gain comprehensive knowledge and hands-on experience with PyTorch.

Neural Network Proficiency: Become proficient in designing and implementing various types of neural networks.

Practical AI Solutions: Develop practical AI solutions that can be deployed in real-world environments.

Unit-1

Introduction to Artificial Intelligence (AI) and Machine Learning (ML) - Understanding the concepts of AI and ML- Differences between AI and ML - Importance and applications of AI and ML in various fields - Overview of the Pytorch framework.

Unit-2

Fundamentals of Pytorch - Introduction to Pytorch and its features - Installation and setup of Pytorch - Basics of tensors and operations in Pytorch - Working with variables and gradients in Pytorch - Data loading and preprocessing using Pytorch.

Unit -3

Supervised Learning with Pytorch - Overview of supervised learning algorithms - Linear regression using Pytorch - Logistic regression using Pytorch - Support Vector Machines (SVM) using Pytorch - Implementing neural networks for classification and regression tasks

Unit-4

Unsupervised Learning with Pytorch - Overview of unsupervised learning algorithms - K-means clustering using Pytorch - Hierarchical clustering using Pytorch - Principal Component Analysis (PCA) using Pytorch - Autoencoders and dimensionality reduction techniques

Unit-5

Deep Learning with Pytorch - Introduction to deep learning and neural networks - Building and training deep neural networks using Pytorch - Convolutional Neural Networks (CNN) using Pytorch - Recurrent Neural Networks (RNN) using Pytorch - Transfer learning and fine-tuning with Pytorch

REFERANCE

Pytorch Deep Learning By Example

By Benjamin Young

PyTorch Pocket Reference: Building and Deploying Deep Learning Models by Jeo Papo



HOD

Department of Computer Science
School of Arts and Science
Ponnalyah Ramalayam Institute of
Science and Technology (PRIST)
Thanjavur - 813 403.



DEAN

School of Arts & Science
Ponnalyah Ramalayam Institute of
Science & Technology (PRIST)
Deemed to be University
Vellam, Thanjavur - 813 403.



PONNAIYAH RAMAJAYAM INSTITUTE OF
SCIENCE & TECHNOLOGY (PRIST)

DECLINED AS DEFINED-TO BE UNIVERSITY
Act No. 41 of 1993, Act, 1993

STUDENT ATTENDANCE LIST

B.Sc CS/BCA- Certificate course on Designing (Photoshop, Premium, Illustrator)
III BSCCS

S.No	Name of the Student	Reg Number	17.7.23	18.7.23	19.7.23	21.7.23	25.7.23	26.7.23	28.7.23	31.7.23	1.8.23	2.8.23	4.8.23	8.8.23	9.8.23	10.8.23	14.8.23	16.8.23	17.8.23	18.8.23	7.9.23	8.9.23	12.9.23	13.9.23
1.	S.SUGA JOTHI	2101CS10201	D	D	D	D	D	D	D	D	D	D	D	D	D	D	D	D	D	D	D	D	D	D
2.	T.BALASUNDARI	2101CS10202	D	D	D	D	D	D	D	D	D	D	D	D	D	D	D	D	D	D	D	D	D	D
3.	P.DURGA	2101CS10203	D	D	D	D	D	D	D	D	D	D	D	D	D	D	D	D	D	D	D	D	D	D
4.	G.POMMI	2101CS10204	D	D	D	D	D	D	D	D	D	D	D	D	D	D	D	D	D	D	D	D	D	D
5.	A.RAMYA	2101CS10205	D	D	D	D	D	D	D	D	D	D	D	D	D	D	D	D	D	D	D	D	D	D
6.	M.SRINITHIYA	2101CS10206	A	D	D	D	D	D	D	D	D	D	D	D	D	D	D	D	D	D	D	D	D	D
7.	M.SUBBULAKSHMI	2101CS10207	D	D	D	D	D	D	D	D	D	D	D	D	D	D	D	D	D	D	D	D	D	D
8.	EJAS AHAMED M	2101CS10102	D	D	D	D	D	D	D	D	D	D	D	D	D	D	D	D	D	D	D	D	D	D
9.	SUNANESAN S	2101CS10103	D	D	D	D	D	D	D	D	D	D	D	D	D	D	D	D	D	D	D	D	D	D
10.	S.SIVAKUMAR	2101CS10104	D	D	D	D	D	D	D	D	D	D	D	D	D	D	D	D	D	D	D	D	D	D
11.	S.RIZWAN	2101CS10105	D	D	D	D	D	D	D	D	D	D	D	D	D	D	D	D	D	D	D	D	D	D
12.	RAMACHANDIRAN R	2101CS10106	D	D	D	D	D	D	D	D	D	D	D	D	D	D	D	D	D	D	D	D	D	D
13.	C.ASWINKUMAR	2101CS10107	D	D	D	D	D	D	D	D	D	D	D	D	D	D	D	D	D	D	D	D	D	D
14.	R.PRAVEEN KUMAR	2101CS10108	D	D	D	D	D	D	D	D	D	D	D	D	D	D	D	D	D	D	D	D	D	D
15.	S.MADHANKUMAR	2101CS10109	D	D	D	D	D	D	D	D	D	D	D	D	D	D	D	D	D	D	D	D	D	D
16.	S.K.RUBAN	2101CS10110	D	D	D	D	D	D	D	D	D	D	D	D	D	D	D	D	D	D	D	D	D	D
17.	HARIPRASATH S	2101CS10111	D	D	D	D	D	D	D	D	D	D	D	D	D	D	D	D	D	D	D	D	D	D
18.	S.ARUN	2101CS10112	D	D	D	D	D	D	D	D	D	D	D	D	D	D	D	D	D	D	D	D	D	D
19.	S.PRAGADEESH	2101CS10113	D	D	D	D	D	D	D	D	D	D	D	D	D	D	D	D	D	D	D	D	D	D
20.	S.ESAKKI	2101CS10114	D	D	D	D	D	D	D	D	D	D	D	D	D	D	D	D	D	D	D	D	D	D
21.	G.HARIHARAN	2101CS10115	D	D	D	D	D	D	D	D	D	D	D	D	D	D	D	D	D	D	D	D	D	D
22.	S.AKASH	2101CS10116	D	D	D	D	D	D	D	D	D	D	D	D	D	D	D	D	D	D	D	D	D	D

Department of Computer Science
School of Arts and Science
Ponnaiyah Ramajayam Institute of
Science and Technology (PRIST)
Thanjavur - 613 403.

School of Arts & Science
Ponnaiyah Ramajayam Institute of
Science & Technology (PRIST)



PONNAIYAH RAMAJAYAM INSTITUTE OF
SCIENCE & TECHNOLOGY (PRIST)

Established under the PRIST Act, 1955
Dated 21.05.1955

STUDENT ATTENDANCE LIST

B.Sc CS/BCA - Certificate course on Web Application Development and Hosting

Sl. NO	Name of the Student	Reg Number	17.7.23	18.7.23	19.7.23	20.7.23	21.7.23	22.7.23	23.7.23	24.7.23	25.7.23	26.7.23	27.7.23	28.7.23	29.7.23	30.7.23	31.7.23	1.8.23	2.8.23	3.8.23	4.8.23	5.8.23	6.8.23	7.8.23	8.8.23	9.8.23	10.8.23	11.8.23	12.8.23	13.8.23	14.8.23	15.8.23	16.8.23	17.8.23	18.8.23	19.8.23	20.8.23	21.8.23	22.8.23	23.8.23	24.8.23	25.8.23	26.8.23	27.8.23	28.8.23	29.8.23	30.8.23	31.8.23																			
1	K. BHUVANESHKUMAR	2101CS10135	P	P	P	P	P	P	P	P	P	P	P	P	P	P	P	P	P	P	P	P	P	P	P	P	P	P	P	P	P	P	P	P	P	P	P	P	P	P	P	P	P	P	P	P	P	P	P	P	P																
2	R. VIJAY	2101CS10136	P	P	P	P	P	P	P	P	P	P	P	P	P	P	P	P	P	P	P	P	P	P	P	P	P	P	P	P	P	P	P	P	P	P	P	P	P	P	P	P	P	P	P	P	P	P	P	P	P	P	P	P													
3	S. KEERTHIIVASAN	2101CS10137	P	P	P	P	P	P	P	P	P	P	P	P	P	P	P	P	P	P	P	P	P	P	P	P	P	P	P	P	P	P	P	P	P	P	P	P	P	P	P	P	P	P	P	P	P	P	P	P	P	P	P	P	P												
4	FELIX BHARATH R	2101CS10138	P	P	P	P	P	P	P	P	P	P	P	P	P	P	P	P	P	P	P	P	P	P	P	P	P	P	P	P	P	P	P	P	P	P	P	P	P	P	P	P	P	P	P	P	P	P	P	P	P	P	P	P	P	P											
5	A. KAMESHWARAN	2101CS10139	P	P	P	P	P	P	P	P	P	P	P	P	P	P	P	P	P	P	P	P	P	P	P	P	P	P	P	P	P	P	P	P	P	P	P	P	P	P	P	P	P	P	P	P	P	P	P	P	P	P	P	P	P	P	P										
6	K. YOGESH	2101CS10140	A	P	P	P	P	P	P	P	P	P	P	P	P	P	P	P	P	P	P	P	P	P	P	P	P	P	P	P	P	P	P	P	P	P	P	P	P	P	P	P	P	P	P	P	P	P	P	P	P	P	P	P	P	P											
7	SANGEETHA D	2101CS10208	P	P	P	P	P	P	P	P	P	P	P	P	P	P	P	P	P	P	P	P	P	P	P	P	P	P	P	P	P	P	P	P	P	P	P	P	P	P	P	P	P	P	P	P	P	P	P	P	P	P	P	P	P	P	P	P									
8	SARANYA L	2101CS10209	P	P	P	P	P	P	P	P	P	P	P	P	P	P	P	P	P	P	P	P	P	P	P	P	P	P	P	P	P	P	P	P	P	P	P	P	P	P	P	P	P	P	P	P	P	P	P	P	P	P	P	P	P	P	P	P	P								
9	SIVAPRIYA P	2101CS10210	P	P	P	P	P	P	P	P	P	P	P	P	P	P	P	P	P	P	P	P	P	P	P	P	P	P	P	P	P	P	P	P	P	P	P	P	P	P	P	P	P	P	P	P	P	P	P	P	P	P	P	P	P	P	P	P	P	P							
10	SUSISTRAS	2101CS10211	P	P	P	P	P	P	P	P	P	P	P	P	P	P	P	P	P	P	P	P	P	P	P	P	P	P	P	P	P	P	P	P	P	P	P	P	P	P	P	P	P	P	P	P	P	P	P	P	P	P	P	P	P	P	P	P	P	P	P	P	P	P	P	P	P

III B.SC|CS



HOD

Department of Computer Science
School of Arts and Science
Ponnaiyah Ramajayam Institute of
Science and Technology (PRIST)
Thanjavur - 613 403.



DEAN

School of Arts & Science
Ponnaiyah Ramajayam Institute of
Science & Technology (PRIST)
Deemed to be University
Valliam, Thanjavur - 613 403.

Sl. NO	Name of the Student	Reg Number	17.7.23	18.7.23	19.7.23	29.7.23	21.7.23	25.7.23	26.7.23	28.7.23	31.7.23	1.8.23	2.8.23	4.8.23	8.8.23	9.8.23	10.8.23	14.8.23	16.8.23	17.8.23	18.8.23	7.9.23	8.9.23	12.9.23	13.9.23	
1	KAVIMANI M	2010CA10101	P	P	P	P	P	P	P	P	P	P	P	P	P	P	P	P	P	P	P	P	P	P	P	
2	R.PRAKASHI	2101CA10102	P	P	P	P	P	P	P	P	P	P	P	P	P	P	P	P	P	P	P	P	P	P	P	P
3	D.AKASH	2101CA10104	P	P	P	P	P	P	P	P	P	P	P	P	P	P	P	P	P	P	P	P	P	P	P	P
4	M.DHINESH BALAJI	2101CA10105	P	P	P	P	P	P	P	P	P	P	P	P	P	P	P	P	P	P	P	P	P	P	P	P
5	A.ARSHAD JASIR	2101CA10106	P	P	P	P	P	P	P	P	P	P	P	P	P	P	P	P	P	P	P	P	P	P	P	P
6	M.HAREESH	2101CA10107	A	P	P	P	P	P	P	P	P	P	P	P	P	P	P	P	P	P	P	P	P	P	P	P
7	M.VEERAKUMAR	2101CA10108	P	P	P	P	P	P	P	P	P	P	P	P	P	P	P	P	P	P	P	P	P	P	P	P
8	A.NAVEEBRAJ	2101CA10110	P	P	P	P	P	P	P	P	P	P	P	P	P	P	P	P	P	P	P	P	P	P	P	P
9	B.MITHUNRAJ	2101CA10111	P	P	P	P	P	P	P	P	P	P	P	P	P	P	P	P	P	P	P	P	P	P	P	P
10	M.FAYAS AHAMED	2101CA10112	P	P	P	P	P	P	P	P	P	P	P	P	P	P	P	P	P	P	P	P	P	P	P	P
11	MADHAN KUMAR G	2101CA10113	P	P	P	P	P	P	P	P	P	P	P	P	P	P	P	P	P	P	P	P	P	P	P	P
12	E.TAMIZHARASAN	2101CA10114	P	P	P	P	P	P	P	P	P	P	P	P	P	P	P	P	P	P	P	P	P	P	P	P
13	MOHAMED HABZAR H	2101CA10115	P	P	P	P	P	P	P	P	P	P	P	P	P	P	P	P	P	P	P	P	P	P	P	P
14	K.MOHAMED FAYAS	2101CA10116	P	P	P	P	P	P	P	P	P	P	P	P	P	P	P	P	P	P	P	P	P	P	P	P
15	MOHAMED SIRAJUDEN S	2101CA10117	P	P	P	P	P	P	P	P	P	P	P	P	P	P	P	P	P	P	P	P	P	P	P	P
16	J.MOHAMED BILAL J	2101CA10118	P	P	P	P	P	P	P	P	P	P	P	P	P	P	P	P	P	P	P	P	P	P	P	P
17	SUNDARESWARAN M	2101CA10119	P	P	P	P	P	P	P	P	P	P	P	P	P	P	P	P	P	P	P	P	P	P	P	P
18	L.SELVA	2101CA10120	P	P	P	P	P	P	P	P	P	P	P	P	P	P	P	P	P	P	P	P	P	P	P	P
19	R.SANTHOSH	2101CA10121	P	P	P	P	P	P	P	P	P	P	P	P	P	P	P	P	P	P	P	P	P	P	P	P
20	U.GOKUL	2101CA10122	P	P	P	P	P	P	P	P	P	P	P	P	P	P	P	P	P	P	P	P	P	P	P	P
21	T.HARI HARA SUDHAN	2101CA10123	P	P	P	P	P	P	P	P	P	P	P	P	P	P	P	P	P	P	P	P	P	P	P	P
22	PAKASH	2101CA10124	P	P	P	P	P	P	P	P	P	P	P	P	P	P	P	P	P	P	P	P	P	P	P	P
23	M.AHILESHWARAN	2101CA10125	A	P	P	P	P	P	P	P	P	P	P	P	P	P	P	P	P	P	P	P	P	P	P	P
24	J.MUKESH RAO	2101CA10126	P	P	P	P	P	P	P	P	P	P	P	P	P	P	P	P	P	P	P	P	P	P	P	P
25	GURUPRASATH K	2101CA10127	P	P	P	P	P	P	P	P	P	P	P	P	P	P	P	P	P	P	P	P	P	P	P	P
26	S.HARIHARAN	2101CA10128	A	P	P	P	P	P	P	P	P	P	P	P	P	P	P	P	P	P	P	P	P	P	P	P
27	M.TIINAKARAN	2101CA10109	P	P	P	P	P	P	P	P	P	P	P	P	P	P	P	P	P	P	P	P	P	P	P	P
28	S.MATHESH	2101CA10129	P	P	P	P	P	P	P	P	P	P	P	P	P	P	P	P	P	P	P	P	P	P	P	P
29	V.MARIYAPPAN	2101CA10130	P	P	P	P	P	P	P	P	P	P	P	P	P	P	P	P	P	P	P	P	P	P	P	P

HOD

Department of Computer Science
School of Arts and Science
Pranayesh Ramsjeyam Institute of
Science and Technology (PRIST)
Thanjavur - 613 403.

DEAN

School of Arts & Science
Pranayesh Ramsjeyam Institute of
Science and Technology (PRIST)
Thanjavur - 613 403.



PONNAIYAH RAMAJAYAM INSTITUTE OF
SCIENCE & TECHNOLOGY (PRIST)

DECEMBER 1958
U.S. AT JEROME AVE. 1958

STUDENT ATTENDANCE LIST
B.Sc CS/BCA-Certificate course on Android App Development
III BCA

Sl. NO	Name of the Student	Reg Number	17.7.23	18.7.23	19.7.23	29.7.23	21.7.23	25.7.23	26.7.23	28.7.23	31.7.23	1.8.23	2.8.23	4.8.23	8.8.23	9.8.23	10.8.23	14.8.23	16.8.23	17.8.23	18.8.23	7.9.23	8.9.23	12.9.23	13.9.23
1	N.ARUN	2101CA10131	P	P	P	P	P	P	P	P	P	P	P	P	P	P	P	P	P	P	P	P	P	P	P
2	M.VIJAY	2101CA10132	P	P	P	P	P	P	P	P	P	P	P	P	P	P	P	P	P	P	P	P	P	P	P
3	ST DINESH	2101CA10133	P	P	P	P	P	P	P	P	P	P	P	P	P	P	P	P	P	P	P	P	P	P	P
4	R.A.RISHI RAJAN	2101CA10134	P	P	P	P	P	P	P	P	P	P	P	P	P	P	P	P	P	P	P	P	P	P	P
5	K.N.MADHAVA KANNAN	2101CA10135	P	P	P	P	P	P	P	P	P	P	P	P	P	P	P	P	P	P	P	P	P	P	P
6	A.SWAMINATHAN	2101CA10136	A	P	P	P	P	P	P	P	P	P	P	P	P	P	P	P	P	P	P	P	P	P	P
7	M.VEMBARASAN	2101CA10137	P	P	P	P	P	P	P	P	P	P	P	P	P	P	P	P	P	P	P	P	P	P	P
8	S.ARULRAJ	2101CA10138	P	P	P	P	P	P	P	P	P	P	P	P	P	P	P	P	P	P	P	P	P	P	P
9	K.SIVA	2101CA10139	P	P	P	P	P	P	P	P	P	P	P	P	P	P	P	P	P	P	P	P	P	P	P
10	S.NANTHAKUMAR	2101CA10140	P	P	P	P	P	P	P	P	P	P	P	P	P	P	P	P	P	P	P	P	P	P	P
11	K.SANJAI KANNAN	2101CA10141	P	P	P	P	P	P	P	P	P	P	P	P	P	P	P	P	P	P	P	P	P	P	P
12	D.JAGADEESAN	2101CA10142	P	P	P	P	P	P	P	P	P	P	P	P	P	P	P	P	P	P	P	P	P	P	P
13	V.KAVIYARASAN	2101CA10143	P	P	P	P	P	P	P	P	P	P	P	P	P	P	P	P	P	P	P	P	P	P	P
14	P.GOKUL	2101CA10144	P	P	P	P	P	P	P	P	P	P	P	P	P	P	P	P	P	P	P	P	P	P	P
15	R.PRAGADEESH	2101CA10145	P	P	P	P	P	P	P	P	P	P	P	P	P	P	P	P	P	P	P	P	P	P	P
16	S.GOWRIDHANYAYAN	2101CA10146	P	P	P	P	P	P	P	P	P	P	P	P	P	P	P	P	P	P	P	P	P	P	P
17	E.SIKAN	2101CA10147	P	P	P	P	P	P	P	P	P	P	P	P	P	P	P	P	P	P	P	P	P	P	P
18	M.ARIHARAN	2101CA10148	P	P	P	P	P	P	P	P	P	P	P	P	P	P	P	P	P	P	P	P	P	P	P
19	M.EHIYA RAIHAN	2101CA10149	P	P	P	P	P	P	P	P	P	P	P	P	P	P	P	P	P	P	P	P	P	P	P
20	P.KRISHNAN	2101CA10150	P	P	P	P	P	P	P	P	P	P	P	P	P	P	P	P	P	P	P	P	P	P	P
21	P.SURESH KUMAR	2101CA10151	P	P	P	P	P	P	P	P	P	P	P	P	P	P	P	P	P	P	P	P	P	P	P

[Signature]

HOD
Department of Computer Science
School of Arts and Science
Ponnaiyah Ramajayam Institute of
Science and Technology (PRIST)
Thanjavur - 613 013

DEAN

[Signature]
School of Arts & Science
Ponnaiyah Ramajayam Institute of
Science & Technology (PRIST)
Deemed to be University
Thanjavur - 613 013

II BSC CS

Sl. NO	Name of the Student	Reg. Number	17.7.23	18.7.23	19.7.23	29.7.23	21.7.23	25.7.23	26.7.23	28.7.23	31.7.23	1.8.23	2.8.23	4.8.23	8.8.23	9.8.23	10.8.23	14.8.23	16.8.23	17.8.23	18.8.23	7.9.23	8.9.23	12.9.23	13.9.23	
1	VEERAMANI K	2201CS10101	P	P	P	P	P	P	P	P	P	P	P	P	P	P	P	P	P	P	P	P	P	P	P	P
2	ABINASH V	2201CS10102	P	P	P	P	P	P	P	P	P	P	P	P	P	P	P	P	P	P	P	P	P	P	P	P
3	RAGHU R	2201CS10103	P	P	P	P	P	P	P	P	P	P	P	P	P	P	P	P	P	P	P	P	P	P	P	P
4	MANISHKANTH P S	2201CS10104	P	P	P	P	P	P	P	P	P	P	P	P	P	P	P	P	P	P	P	P	P	P	P	P
5	SANJAI I	2201CS10105	P	P	P	P	P	P	P	P	P	P	P	P	P	P	P	P	P	P	P	P	P	P	P	P
6	MANIKANDAN K	2201CS10106	A	P	P	P	P	P	P	P	P	P	P	P	P	P	P	P	P	P	P	P	P	P	P	P
7	JAGADESHWARAN P	2201CS10107	P	P	P	P	P	P	P	P	P	P	P	P	P	P	P	P	P	P	P	P	P	P	P	P
8	PRAVEEN B	2201CS10108	P	P	P	P	P	P	P	P	P	P	P	P	P	P	P	P	P	P	P	P	P	P	P	P
9	MOHAMED THOUFIK M	2201CS10110	P	P	P	P	P	P	P	P	P	P	P	P	P	P	P	P	P	P	P	P	P	P	P	P
10	KESHAVARAM M S	2201CS10111	P	P	P	P	P	P	P	P	P	P	P	P	P	P	P	P	P	P	P	P	P	P	P	P
11	SANTHOSH S	2201CS10112	P	P	P	P	P	P	P	P	P	P	P	P	P	P	P	P	P	P	P	P	P	P	P	P
12	ABISHEK E	2201CS10113	P	P	P	P	P	P	P	P	P	P	P	P	P	P	P	P	P	P	P	P	P	P	P	P
13	VINOTH S	2201CS10114	P	P	P	P	P	P	P	P	P	P	P	P	P	P	P	P	P	P	P	P	P	P	P	P
14	SARAN C	2201CS10115	P	P	P	P	P	P	P	P	P	P	P	P	P	P	P	P	P	P	P	P	P	P	P	P
15	KARTHIK S	2201CS10116	P	P	P	P	P	P	P	P	P	P	P	P	P	P	P	P	P	P	P	P	P	P	P	P

HOD
 Department of Computer Science
 School of Arts and Science
 Ponnaiyah Ramajayam Institute of
 Science and Technology (PRIST)
 Thanjavur - 613 403.

DEAN
 School of Arts & Science
 Ponnaiyah Ramajayam Institute of
 Science & Technology (PRIST)
 Deemed to be University
 Valliam, Thanjavur - 613 403.



**PONNAIYAH RAMAJAYAM INSTITUTE OF
SCIENCE & TECHNOLOGY (PRIST)**

Declared as DEEMED TO BE UNIVERSITY
Uts 3 of JGC Act, 1956

STUDENT ATTENDANCE LIST
B.Sc CS/BCA-Certificate course on Software Testing using Selenium
II BSC CS

Sl. NO	Name of the Student	Reg Number	17.7.23	18.7.23	19.7.23	21.7.23	25.7.23	26.7.23	28.7.23	31.7.23	1.8.23	2.8.23	4.8.23	8.8.23	9.8.23	10.8.23	14.8.23	16.8.23	17.8.23	18.8.23	7.9.23	8.9.23	12.9.23	13.9.23	
1	BOOPATHI V	2201CS10117	P	P	P	P	P	P	P	P	P	P	P	P	P	P	P	P	P	P	P	P	P	P	P
2	SARANRAJ D	2201CS10118	P	P	P	P	P	P	P	P	P	P	P	P	P	P	P	P	P	P	P	P	P	P	P
3	RAGUL GANDHIR	2201CS10119	P	P	P	P	P	P	P	P	P	P	P	P	P	P	P	P	P	P	P	P	P	P	P
4	RAJINI KUMAR M	2201CS10120	P	P	P	P	P	P	P	P	P	P	P	P	P	P	P	P	P	P	P	P	P	P	P
5	DHINESH B	2201CS10121	P	P	P	P	P	P	P	P	P	P	P	P	P	P	P	P	P	P	P	P	P	P	P
6	HEMAVARSHAN T	2201CS10122	A	P	P	P	P	P	P	P	P	P	P	P	P	P	P	P	P	P	P	P	P	P	P
7	MADHESWARAN M	2201CS10123	P	P	P	P	P	P	P	P	P	P	P	P	P	P	P	P	P	P	P	P	P	P	P
8	RETHNESWARI S	2201CS10201	P	P	P	P	P	P	P	P	P	P	P	P	P	P	P	P	P	P	P	P	P	P	P
9	GAYATHRI THIRISHA K	2201CS10202	P	P	P	P	P	P	P	P	P	P	P	P	P	P	P	P	P	P	P	P	P	P	P
10	BHUVANESHWARI S	2201CS10203	P	P	P	P	P	P	P	P	P	P	P	P	P	P	P	P	P	P	P	P	P	P	P
11	ABIRAMI R	2201CS10204	P	P	P	P	P	P	P	P	P	P	P	P	P	P	P	P	P	P	P	P	P	P	P
12	AARTHI P	2201CS10205	P	P	P	P	P	P	P	P	P	P	P	P	P	P	P	P	P	P	P	P	P	P	P
13	BHAVANI K	2201CS10206	P	P	P	P	P	P	P	P	P	P	P	P	P	P	P	P	P	P	P	P	P	P	P
14	SANDHIYA S	2201CS10207	P	P	P	P	P	P	P	P	P	P	P	P	P	P	P	P	P	P	P	P	P	P	P
15	SENGAR	2201CS10208	P	P	P	P	P	P	P	P	P	P	P	P	P	P	P	P	P	P	P	P	P	P	P
16	SOUNDHARYA S	2201CS10209	P	P	P	P	P	P	P	P	P	P	P	P	P	P	P	P	P	P	P	P	P	P	P
17	SIVAGAMI M	2201CS10210	P	P	P	P	P	P	P	P	P	P	P	P	P	P	P	P	P	P	P	P	P	P	P
18	ELAKKIYA S	2201CS10211	P	P	P	P	P	P	P	P	P	P	P	P	P	P	P	P	P	P	P	P	P	P	P
19	SARANYA S	2201CS10212	P	P	P	P	P	P	P	P	P	P	P	P	P	P	P	P	P	P	P	P	P	P	P
20	GAYATHRI M	2201CS10213	P	P	P	P	P	P	P	P	P	P	P	P	P	P	P	P	P	P	P	P	P	P	P
21	NISHA R	2201CS10214	P	P	P	P	P	P	P	P	P	P	P	P	P	P	P	P	P	P	P	P	P	P	P
22	NIVETHA M HOB	2201CS10215	P	P	P	P	P	P	P	P	P	P	P	P	P	P	P	P	P	P	P	P	P	P	P

sm

su

School of Arts & Science
Ponnaiyah Ramajayam Institute of
Science & Technology (PRIST)
Examined to be University

Department of Computer Science
School of Arts and Science
Ponnaiyah Ramajayam Institute of
Science and Technology (PRIST)
Thanjavur - 613 403.

DEAN



STUDENT ATTENDANCE LIST
B.Sc CS/BCA-Certificate course on Google IT Support
II BCA

Sl. NO	Name of the Student	Reg Number	23.1.24	24.1.24	25.1.24	29.1.24	30.1.24	31.1.24	1.2.24	2.2.24	5.2.24	7.2.24	9.2.24	12.2.24	13.2.24	15.2.24	16.2.24	20.2.24	21.2.24	4.3.24	5.3.24	7.3.24	12.3.24	13.3.24	14.3.24	
1.	ABDUR RAHMAN A	2201CA10101	P	P	P	P	P	P	P	P	P	P	P	P	P	P	P	P	P	P	P	P	P	P	P	P
2.	VISHVA GANESH J	2201CA10103	P	P	P	P	P	P	P	P	P	P	P	P	P	P	P	P	P	P	P	P	P	P	P	P
3.	DINESH R	2201CA10105	P	P	P	P	P	P	P	P	P	P	P	P	P	P	P	P	P	P	P	P	P	P	P	P
4.	ELAKTYAN I	2201CA10106	P	P	P	P	P	P	P	P	P	P	P	P	P	P	P	P	P	P	P	P	P	P	P	P
5.	SANJAY KUMAR S	2201CA10107	P	P	P	P	P	P	P	P	P	P	P	P	P	P	P	P	P	P	P	P	P	P	P	P
6.	MOHAMED MANAS J	2201CA10109	A	P	P	P	P	P	P	P	P	P	P	P	P	P	P	P	P	P	P	P	P	P	P	P
7.	MOHAMED AFIR ABU MUMEEN M	2201CA10110	P	P	P	P	P	P	P	P	P	P	P	P	P	P	P	P	P	P	P	P	P	P	P	P
8.	MOHAMED THOUFIC S	2201CA10112	P	P	P	P	P	P	P	P	P	P	P	P	P	P	P	P	P	P	P	P	P	P	P	P
9.	MANOJ S	2201CA10113	P	P	P	P	P	P	P	P	P	P	P	P	P	P	P	P	P	P	P	P	P	P	P	P
10.	MOHAMED IMRAN J	2201CA10114	P	P	P	P	P	P	P	P	P	P	P	P	P	P	P	P	P	P	P	P	P	P	P	P
11.	SRIRAM	2201CA10116	P	P	P	P	P	P	P	P	P	P	P	P	P	P	P	P	P	P	P	P	P	P	P	P
12.	ABINESH A	2201CA10117	P	P	P	P	P	P	P	P	P	P	P	P	P	P	P	P	P	P	P	P	P	P	P	P
13.	HARISH G	2201CA10118	P	P	P	P	P	P	P	P	P	P	P	P	P	P	P	P	P	P	P	P	P	P	P	P
14.	SURENTHARAN K	2201CA10119	P	P	P	P	P	P	P	P	P	P	P	P	P	P	P	P	P	P	P	P	P	P	P	P
15.	SUNIL KUMAR M	2201CA10120	P	P	P	P	P	P	P	P	P	P	P	P	P	P	P	P	P	P	P	P	P	P	P	P
16.	DHANESH PRABU	2201CA10121	P	P	P	P	P	P	P	P	P	P	P	P	P	P	P	P	P	P	P	P	P	P	P	P
17.	PRAVIN V	2201CA10123	P	P	P	P	P	P	P	P	P	P	P	P	P	P	P	P	P	P	P	P	P	P	P	P
18.	SHEESHATHIRY R	2201CA10125	P	P	P	P	P	P	P	P	P	P	P	P	P	P	P	P	P	P	P	P	P	P	P	P
19.	SATHISH P	2201CA10126	P	P	P	P	P	P	P	P	P	P	P	P	P	P	P	P	P	P	P	P	P	P	P	P
20.	LOGESHWARA S	2201CA10127	P	P	P	P	P	P	P	P	P	P	P	P	P	P	P	P	P	P	P	P	P	P	P	P
21.	PRAGADESHI K S	2201CA10128	P	P	P	P	P	P	P	P	P	P	P	P	P	P	P	P	P	P	P	P	P	P	P	P
22.	MANIMARAN A	2201CA10129	P	P	P	P	P	P	P	P	P	P	P	P	P	P	P	P	P	P	P	P	P	P	P	P

HOD
 Department of Computer Science
 School of Arts and Science
 Ponnaiyah Ramejyam Institute of
 Science and Technology (PRIST)

DEAN
 School of Arts & Science
 Ponnaiyah Ramejyam Institute of
 Science & Technology (PRIST)
 Deemed to be University

23.	NITHISH KUMAR T	2201CA10131	A	P	P	P	P	P	P	P	P	P	P	P	P	P	P	P	P	P	P	P	P	P	P	P	P		
24.	BAI AJI K	2201CA10132	P	P	P	P	P	P	P	P	P	P	P	P	P	P	P	P	P	P	P	P	P	P	P	P	P	P	
25.	SEENIVASAN M	2201CA10134	P	P	P	P	P	P	A	P	P	P	P	P	P	P	P	P	P	P	P	P	P	P	P	P	P	P	
26.	KALAIMARAN K	2201CA10133	A	P	P	P	P	P	P	P	P	P	P	P	P	P	P	P	P	P	P	P	P	P	P	P	P	P	
27.	MOHAMED THOUFIQ M	2201CA10135	P	P	P	P	P	P	P	P	P	P	P	P	P	P	P	P	P	P	P	A	P	P	P	P	P	P	
28.	BALASINGAM	2201CA10136	P	P	P	P	P	P	P	P	P	P	P	P	P	P	P	P	P	P	P	P	P	P	P	P	P	P	
29.	SHAHUL HAMEED H	2201CA10137	P	P	P	P	P	P	P	P	P	P	P	P	P	P	P	P	P	P	P	P	P	P	P	P	P	P	
30.	KARTHICK RAJ	2201CA10138	P	P	P	P	P	P	P	P	P	P	P	P	P	P	P	P	P	P	P	P	P	P	P	P	P	P	
31.	NISHA E	2201CA10201	P	P	A	P	P	P	P	P	P	P	P	P	P	P	P	P	P	P	P	P	P	P	P	P	P	P	
	DHASNEEM FIRTHOUS			P	P	P	P	P	P	P	P	P	P	P	P	P	P	P	P	P	P	P	P	P	P	P	P	P	
32.	M R	2201CA10202																											
33.	RITHIANYA S	2201CA10203	P	P	P	P	P	P	P	P	P	P	P	P	A	P	P	P	P	P	P	P	P	P	P	P	P	P	
34.	ASMITHA K	2201CA10204	P	P	P	P	P	P	P	P	P	P	P	P	P	P	P	P	P	P	P	P	P	P	P	P	P	P	P
35.	ABIRAMI	2201CA10205	A	P	P	P	P	P	P	P	P	P	P	P	P	P	P	P	P	P	P	P	P	P	P	P	P	P	P
36.	JOSEPHINE ABIGAL M	2201CA10206	P	P	P	P	P	P	P	P	P	P	P	P	P	P	P	P	P	P	P	P	P	P	P	P	P	P	P
37.	SABRITH BEGUM A	2201CA10207	P	P	P	P	P	P	P	P	P	P	P	P	P	P	P	P	P	P	P	P	P	P	P	P	P	P	P

(Signature)

HOD
Department of Computer Science
School of Arts and Science
Annaiyah Ramaswamy Institute of
Science and Technology (PRIST)
Thanjavur - 613 463.

(Signature)

DEAN
School of Arts & Science
Annaiyah Ramaswamy Institute of
Science & Technology (PRIST)
Deemed to be University
Vellam, Thanjavur - 613 463.



STUDENT ATTENDANCE LIST

**B.Sc CS/BCA- Certificate course on Introduction to Cyber Security and Cyber Attacks
II - BCA**

Sl. NO	Name of the Student	Reg Number	23.1.24	24.1.24	25.1.24	29.1.24	30.1.24	31.1.24	1.2.24	2.2.24	5.2.24	7.2.24	9.2.24	12.2.24	13.2.24	15.2.24	16.2.24	20.2.24	21.2.24	4.3.24	5.3.24	7.3.24	12.3.24	13.3.24	14.3.24	
1.	KEERTHIKAM	2201CA10208	P	P	P	P	P	P	P	P	P	P	P	P	P	P	P	P	P	P	P	P	P	P	P	P
2.	RANJISRI S	2201CA10209	P	P	P	P	P	P	P	P	P	P	P	P	P	P	P	P	P	P	P	P	P	P	P	P
3.	AMEERA S	2201CA10211	P	P	P	P	P	P	P	P	P	P	P	P	P	P	P	P	P	P	P	P	P	P	P	P
4.	JENIFER M	2201CA10212	P	P	P	P	P	P	P	P	P	P	P	P	P	P	P	P	P	P	P	P	P	P	P	P
5.	ATCHAYA R	2201CA10213	P	P	P	P	P	P	P	P	P	P	P	P	P	P	A	P	P	P	P	P	P	P	P	P
6.	KAVITHA R	2201CA10214	A	P	P	P	P	P	P	P	P	P	P	P	P	P	P	P	P	P	P	P	P	P	P	P
7.	AARTHI K	2201CA10215	P	P	P	P	P	P	P	P	P	P	P	P	P	P	P	P	P	P	P	P	P	P	P	P
8.	AARTHI R	2201CA10216	P	P	P	P	P	P	P	P	P	P	P	P	P	A	P	P	P	P	P	P	P	P	P	P
9.	USHA J	2201CA10217	P	P	P	P	P	P	P	P	P	P	P	P	P	P	P	P	P	P	P	P	P	P	P	P
10.	GAYATHRI L	2201CA10218	P	P	P	P	P	P	P	P	P	P	P	P	P	P	P	P	P	P	P	P	P	P	P	P
11.	PRIYA H	2201CA10219	P	P	P	P	P	P	P	P	A	P	P	P	P	P	P	P	P	P	P	P	P	P	P	P
12.	ANU PRIYA S	2201CA10220	P	P	P	P	P	P	P	P	P	P	P	P	P	P	P	P	P	P	P	P	P	P	P	P
13.	JASMINE G	2201CA10221	P	P	P	P	P	P	P	P	P	P	P	P	P	P	P	P	P	P	P	P	P	P	P	P

for

HOD
Department of Computer Science
School of Arts and Science
Ponnaiyah Ramajayam Institute of
Science and Technology (PRIST)
Thanjavur - 613 403.

as

DEAN
School of Arts & Science
Ponnaiyah Ramajayam Institute of
Science & Technology (PRIST)
Deemed to be University
Valliam, Thanjavur - 613 403.

Sl. NO	Name of the Student	Reg. Number	23.1.24	24.1.24	25.1.24	29.1.24	30.1.24	31.1.24	1.2.24	2.2.24	5.2.24	7.2.24	9.2.24	12.2.24	13.2.24	15.2.24	16.2.24	20.2.24	21.2.24	4.3.24	5.3.24	7.3.24	12.3.24	13.3.24	14.3.24	
1.	KARMUGIL.R	2301CS10101	P	P	P	P	P	P	P	P	P	P	P	P	P	P	P	P	P	P	P	P	P	P	P	P
2.	PURUSHOTHAMAN.M	2301CS10102	P	P	P	P	P	P	P	P	P	P	P	P	P	P	P	P	P	P	P	P	P	P	P	P
3.	KABILAN.R	2301CS10103	P	P	P	P	P	P	P	P	P	P	P	P	P	P	P	P	P	P	P	P	P	P	P	P
4.	MOHAMED INAYADULLAH.S	2301CS10104	P	P	P	P	P	P	P	P	P	P	P	P	P	P	P	P	P	P	P	P	P	P	P	P
5.	RAGURAM.M	2301CS10105	P	P	P	P	P	P	P	P	P	P	P	P	P	P	P	P	P	P	P	P	P	P	P	P
6.	PRAKASH.S	2301CS10106	A	P	P	P	P	P	P	P	P	P	P	P	P	P	P	P	P	P	P	P	P	P	P	P
7.	DHINESH.K	2301CS10107	P	P	P	P	P	P	P	P	P	P	P	P	P	P	P	P	P	P	P	P	P	P	P	P
8.	MANIKANDAN.K	2301CS10108	P	P	P	P	P	P	P	P	P	P	P	P	P	P	P	P	P	P	P	P	P	P	P	P
9.	AADIHISH.S	2301CS10109	P	P	P	P	P	P	P	P	P	P	P	P	P	P	P	P	P	P	P	P	P	P	P	P
10.	SRIKANTH.R	2301CS10111	P	P	P	P	P	P	P	P	P	P	P	P	P	P	P	P	P	P	P	P	P	P	P	P
11.	KASVINRAJ.B	2301CS10112	P	P	P	P	P	P	P	P	P	P	P	P	P	P	P	P	P	P	P	P	P	P	P	P
12.	VIGNESHWARAN.G	2301CS10115	P	P	P	P	P	P	P	P	P	P	P	P	P	P	P	P	P	P	P	P	P	P	P	P
13.	HARIHARA SELVAN.U	2301CS10116	P	P	P	P	P	P	P	P	P	P	P	P	P	P	P	P	P	P	P	P	P	P	P	P
14.	MAGESHIWARAN.C	2301CS10117	P	P	P	P	P	P	P	P	P	P	P	P	P	P	P	P	P	P	P	P	P	P	P	P
15.	RAHUL.K	2301CS10121	P	P	P	P	P	P	P	P	P	P	P	P	P	P	P	P	P	P	P	P	P	P	P	P
16.	VINOTH.V	2301CS10123	P	P	P	P	P	P	P	P	P	P	P	P	P	P	P	P	P	P	P	P	P	P	P	P
17.	HARIHARAN.K	2301CS10124	P	P	P	P	P	P	P	P	P	P	P	P	P	P	P	P	P	P	P	P	P	P	P	P
18.	SIVA.G	2301CS10125	P	P	P	P	P	P	P	P	P	P	P	P	P	P	P	P	P	P	P	P	P	P	P	P
19.	AROCKIA NAVEEN.S	2301CS10126	P	P	P	P	P	P	P	P	P	P	P	P	P	P	P	P	P	P	P	P	P	P	P	P
20.	MAHA SAKTHI KUMAR.S	2301CS10127	P	P	P	P	P	P	P	P	P	P	P	P	P	P	P	P	P	P	P	P	P	P	P	P
21.	THIRUMALAIVASAN.K	2301CS10128	P	P	P	P	P	P	P	P	P	P	P	P	P	P	P	P	P	P	P	P	P	P	P	P
22.	MURUGADEEPAN.S	2301CS10130	P	P	P	P	P	P	P	P	P	P	P	P	P	P	P	P	P	P	P	P	P	P	P	P
23.	KASIRAMAN.S	2301CS10131	A	P	P	P	P	P	P	P	P	P	P	P	P	P	P	P	P	P	P	P	P	P	P	P

 HOD
 Department of Computer Science
 School of Arts and Science
 Donnelly's Ramaiah Institute of
 Science and Technology (PRIST)
 Thanjavur - 613 403.

 DEAN
 School of Arts & Science
 Donnelly's Ramaiah Institute of
 Science & Technology (PRIST)
 Deemed to be University
 Vellore, Thanjavur - 613 403.



STUDENT ATTENDANCE LIST
B.Sc CS/BCA-Certificate course on Block Chain Technology
I B.SC[CS]

Sl. NO	Name of the Student	Reg Number	23.1.24	24.1.24	25.1.24	29.1.24	30.1.24	31.1.24	1.2.24	2.2.24	5.2.24	7.2.24	9.2.24	12.2.24	13.2.24	15.2.24	16.2.24	20.2.24	21.2.24	4.3.24	5.3.24	7.3.24	12.3.24	13.3.24	14.3.24	
1.	SRIRAM.M	2301CS10132	P	P	P	P	P	P	P	P	P	P	P	P	P	P	P	P	P	P	P	P	P	P	P	P
2.	THIRUMURUGAN.T	2301CS10135	P	P	P	P	P	P	P	P	P	P	P	P	P	P	P	P	P	P	P	P	P	P	P	P
3.	VETHASURYA.S	2301CS10136	P	P	P	P	P	P	P	P	P	P	P	P	P	P	P	P	P	P	P	P	P	P	P	P
4.	VASANTHA KUMAR.L	2301CS10137	P	P	P	P	P	P	P	P	P	P	P	P	P	P	P	P	P	P	P	P	P	P	P	P
5.	VIGNESHWARAN.B	2301CS10138	P	P	P	P	P	P	P	P	P	P	P	P	P	P	P	P	P	P	P	P	P	P	P	P
6.	RAKESH.K	2301CS10139	A	P	P	P	P	P	P	P	P	P	P	P	P	P	P	P	P	P	P	P	P	P	P	P
7.	MADESH.S	2301CS10140	P	P	P	P	P	P	P	P	P	P	P	P	P	P	P	P	P	P	P	P	P	P	P	P
8.	VJAYAKUMAR.M	2301CS10143	P	P	P	P	P	P	P	P	P	P	P	P	P	P	P	P	P	P	P	P	P	P	P	P
9.	ARUNKUMAR.S	2301CS10147	P	P	P	P	P	P	P	P	P	P	P	P	P	P	P	P	P	P	P	P	P	P	P	P
10.	RAHUL.S	2301CS10148	P	P	P	P	P	P	P	P	P	P	P	P	P	P	P	P	P	P	P	P	P	P	P	P
11.	NAGULAN.V	2301CS10149	P	P	P	P	P	P	P	P	P	P	P	P	P	P	P	P	P	P	P	P	P	P	P	P
12.	EASWAR.S	2301CS10151	P	P	P	P	P	P	P	P	A	P	P	P	P	P	P	P	P	P	P	P	P	P	P	P
13.	MUTHUSELVAN.S	2301CS10152	P	P	P	P	P	P	P	P	P	P	P	P	P	P	P	P	P	P	P	P	P	P	P	P
14.	SANTHOSH KUMAR.L	2301CS10153	P	P	P	P	P	P	P	P	P	P	P	P	P	P	P	P	P	P	P	P	P	P	P	P
15.	VALLARASU.D	2301CS10155	P	P	P	P	P	P	P	P	P	P	P	P	P	P	P	P	P	P	P	P	P	P	P	P
16.	SENTHAN.A	2301CS10157	P	P	P	P	P	P	P	P	P	P	P	P	P	P	P	P	P	P	P	P	P	P	P	P
17.	SENTHAMIZHAN.S	2301CS10158	P	P	P	P	P	P	P	P	P	P	P	P	P	P	P	P	P	P	P	P	P	P	P	P
18.	SATHISH.S	2301CS10160	P	P	P	P	P	P	P	P	P	P	P	P	P	P	P	P	P	P	P	P	P	P	P	P
19.	MUKILAN.R	2301CS10161	P	P	P	P	P	P	P	P	P	P	P	P	P	P	P	P	P	P	P	P	P	P	P	P
20.	THINAKARAN.T	2301CS10162	P	P	P	P	P	P	P	P	P	P	P	P	P	P	P	P	P	P	P	P	P	P	P	P
21.	DINAMATHAN.T	2301CS10163	P	P	P	P	P	P	P	P	P	P	P	P	P	P	P	P	P	P	P	P	P	P	P	P
22.	GURUJ.K	2301CS10164	P	P	P	P	P	P	P	P	P	P	P	P	P	P	P	P	P	P	P	P	P	P	P	P
23.	ASHWIN.S	2301CS10165	A	P	P	P	P	P	P	P	P	P	P	P	P	P	P	P	P	P	P	P	P	P	P	P

HOD
Department of Computer Science
School of Arts and Science
Ponnaiyah Ramajayam Institute of
Science and Technology (PRIST)
Thanjavur - 613 403.

DEAN
School of Arts & Science
Ponnaiyah Ramajayam Institute of
Science & Technology (PRIST)
Deemed to be University

24.	VIVIN P	2301CS10166	P	P	P	P	P	P	P	P	P	P	P	P	P	P	P	P	P	P	P	P	P
25.	ARULSAMINATHAN R	2301CS10167	P	P	P	P	P	P	P	P	P	P	P	P	P	P	P	P	P	P	P	P	P
26.	JANAKI.J	2301CS10201	A	P	P	P	P	P	P	P	P	P	P	P	P	P	P	P	P	P	P	P	P
27.	BHUVANESHWARI.R	2301CS10202	P	P	P	P	P	P	P	P	P	P	P	P	P	P	P	P	P	A	P	P	P
28.	AKILANDESHWARI.Y	2301CS10204	P	P	P	P	P	P	P	P	P	P	P	P	P	P	P	P	P	P	P	P	P

I - BCA

Sl.No	Name of the Student	Reg Number	23.12	24.12	25.12	29.12	30.12	31.12	1.2.24	2.2.24	5.2.24	7.2.24	9.2.24	12.2.24	13.2.24	15.2.24	16.2.24	20.2.24	21.2.24	4.3.24	5.3.24	7.3.24	12.3.24	13.3.24	14.3.24	
1.	PAVITHRAN E	2301CA10101	P	P	P	P	P	P	P	P	P	P	P	P	P	P	P	P	P	P	P	P	P	P	P	P
2.	KABILAN M	2301CA10102	P	P	P	P	P	P	P	P	P	P	P	P	P	P	P	P	P	P	P	P	P	P	P	P
3.	SHARUKESH K	2301CA10103	P	P	P	P	P	P	P	P	P	P	P	P	P	P	P	P	P	P	P	P	P	P	P	P
4.	AJAY R	2301CA10104	P	P	P	P	P	P	P	P	P	P	P	P	P	P	P	P	P	P	P	P	P	P	P	P
5.	JEEVAR	2301CA10105	P	P	P	P	P	P	P	P	P	P	P	P	P	P	A	P	P	P	P	P	P	P	P	P
6.	AKASH MUTHU	2301CA10106	A	P	P	P	P	P	P	P	P	P	P	P	P	P	P	P	P	P	P	P	P	P	P	P

 HOD
Department of Computer Science
School of Arts and Science
Annaiah Rameswaram Institute of
Science and Technology (PRIST)
Thanjavur - 613 403.

 DEAN
School of Arts & Sciences
Annaiah Rameswaram Institute of
Science & Technology (PRIST)
Deemed to be University
Vallam, Thanjavur - 613 403.



PONNAIYAH RAMAJAYAM INSTITUTE OF
SCIENCE & TECHNOLOGY (PRIST)

DEPARTMENT OF COMPUTER SCIENCE
SCHOOL OF ARTS AND SCIENCES
PONNAIYAH RAMAJAYAM INSTITUTE OF
SCIENCE & TECHNOLOGY (PRIST)

STUDENT ATTENDANCE LIST

B.Sc CS/BCA- Diploma course on R/Weka Tool

I - BCA

Sl. NO	Name of the Student	Reg Number	20.7.23	21.7.23	24.7.23	25.7.23	26.7.23	27.7.23	28.7.23	31.7.23	28.23	38.23	48.23	88.23	98.23	108.23	148.23	188.23	218.23	228.23	49.23	59.23	69.23	89.23	129.23
1.	JAYASIMMAN D	2301CA10107	P	P	P	P	P	P	P	P	P	P	P	P	P	P	P	P	P	P	P	P	P	P	P
2.	SHEIK ABDULALIM S	2301CA10108	P	P	P	P	P	P	P	P	P	P	P	P	P	P	P	P	P	P	P	P	P	P	P
3.	KANNAN K	2301CA10109	P	P	P	P	P	P	P	P	P	P	P	P	P	P	P	P	P	P	P	P	P	P	P
4.	K.KARAN	2301CA10111	P	P	P	P	P	P	P	P	P	P	P	P	P	P	P	P	P	P	P	P	P	P	P
5.	AJITHKUMAR K	2301CA10112	P	P	P	P	P	P	P	P	P	P	P	P	P	P	P	P	P	P	P	P	P	P	P
6.	DHARANIDHARAN P	2301CA10113	A	P	P	P	P	P	P	P	P	P	P	P	P	P	P	P	P	P	P	P	P	P	P
7.	GURU PANDIYAN.R	2301CA10114	P	P	P	P	P	P	P	P	P	P	P	P	P	P	P	P	P	P	P	P	P	P	P
8.	GUGANESHWARAN B	2301CA10115	P	P	P	P	P	P	P	P	P	P	P	P	P	P	P	P	P	P	P	P	P	P	P
9.	RAJGANESH K	2301CA10117	P	P	P	P	P	P	P	P	P	P	P	P	P	P	P	P	P	P	P	P	P	P	P
10.	SRIRAMAKRISHNAN R	2301CA10118	P	P	P	P	P	P	P	P	P	P	P	P	P	P	P	P	P	P	P	P	P	P	P
11.	AMUTHIAN P	2301CA10119	P	P	P	P	P	P	P	P	P	P	P	P	P	P	P	P	P	P	P	P	P	P	P
12.	SUDHAKARAN S	2301CA10120	P	P	P	P	P	P	P	P	P	P	P	P	P	P	P	P	P	P	P	P	P	P	P
13.	H.MOHAMED AFSAR	2301CA10121	P	P	P	P	P	P	P	P	P	P	P	P	P	P	P	P	P	P	P	P	P	P	P
14.	R.BARATH	2301CA10122	P	P	P	P	P	P	P	P	P	P	P	P	P	P	P	P	P	P	P	P	P	P	P
15.	PRAKASHI.R	2301CA10123	P	P	P	P	P	P	P	P	P	P	P	P	P	P	P	P	P	P	P	P	P	P	P

for

HOD

Department of Computer Science
School of Arts and Science
Ponnaiyah Ramajayam Institute of
Science and Technology (PRIST)
Thanjavur - 613 403.

ms

DEAN

School of Arts & Sciences
Ponnaiyah Ramajayam Institute of
Science & Technology (PRIST)
Deemed to be University
Vallam, Thanjavur - 613 403.

STUDENT ATTENDANCE LIST
B.Sc CS/BCA- Diploma course on R/Weka Tool

I - BCA

Sl. NO	Name of the Student	Reg Number	14.9.23	18.9.23	20.9.23	21.9.23	25.9.23	27.9.23	5.10.23	10.10.23	11.10.23	12.10.23	16.10.23	17.10.23	18.10.23	19.10.23	20.10.23	6.11.23	7.11.23	12.12.23	13.12.23	14.12.23	15.12.23	18.12.23	
1.	JAYASIMMAN D	2301CA10107	P	P	P	P	P	P	P	P	P	P	P	P	P	P	P	P	P	P	P	P	P	P	P
2.	SHEIK ABDUL ALIM S	2301CA10108	P	P	P	P	P	P	P	P	P	P	P	P	P	P	P	P	P	P	P	P	P	P	P
3.	KANNAN K	2301CA10109	P	P	P	P	P	P	P	P	P	P	P	P	P	P	P	P	P	P	P	P	P	P	P
4.	K.KARAN	2301CA10111	P	P	P	P	P	P	P	P	P	P	P	P	P	P	P	P	P	P	P	P	P	P	P
5.	AJITHKUMAR K	2301CA10112	P	P	P	P	P	P	P	P	P	P	P	P	P	P	P	P	P	P	P	P	P	P	P
6.	DHARANIDHARAN P	2301CA10113	A	P	P	P	P	P	P	P	P	P	P	P	P	P	P	P	P	P	P	P	P	P	P
7.	GURU PANDIYAN R	2301CA10114	P	P	P	P	P	P	P	P	P	P	P	P	P	P	P	P	P	P	P	P	P	P	P
8.	GUGANESHWARAN B	2301CA10115	P	P	P	P	P	P	P	P	P	P	P	P	P	P	P	P	P	P	P	P	P	P	P
9.	RAJGANESHI K	2301CA10117	P	P	P	P	P	P	P	P	P	P	P	P	P	P	P	P	P	P	P	P	P	P	P
10.	SRIRAMAKRISHNAN R	2301CA10118	P	P	P	P	P	P	P	P	P	P	P	P	P	P	P	P	P	P	P	P	P	P	P
11.	AMUTHAN P	2301CA10119	P	P	P	P	P	P	P	P	P	P	P	P	P	P	P	P	P	P	P	P	P	P	P
12.	SUDHAKARAN S	2301CA10120	P	P	P	P	P	P	P	P	P	P	P	P	P	P	P	P	P	P	P	P	P	P	P
13.	H.MOHAMED AFSAR	2301CA10121	P	P	P	P	P	P	P	P	P	P	P	P	P	P	P	P	P	P	P	P	P	P	P
14.	R.BARATH	2301CA10122	P	P	P	P	P	P	P	P	P	P	P	P	P	P	P	P	P	P	P	P	P	P	P
15.	PRAKASH R	2301CA10123	P	P	P	P	P	P	P	P	P	P	P	P	P	P	P	P	P	P	P	P	P	P	P

HOD
Department of Computer Science
School of Arts and Science
Ponnaiyah Ramejyam Institute of
Science and Technology (PRIST)
Thanjavur - 613 403.

DEAN
School of Arts & Science
Ponnaiyah Ramejyam Institute of
Science & Technology (PRIST)
Deemed to be University
Valliam, Thanjavur - 613 403.



**PONNAIYAH RAMAJAYAM INSTITUTE OF
SCIENCE & TECHNOLOGY (PRIST)**

DECLARED AS DEEMED TO BE UNIVERSITY
U.S. 2, 11, 100 ACT, 1956

STUDENTS ATTENDANCE LIST

**B.Sc CS/BCA- Diploma course on Web Designing & Hosting
I - BCA**

Sl. NO	Name of the Student	Reg Number	20.7.23	21.7.23	24.7.23	25.7.23	26.7.23	27.7.23	28.7.23	31.7.23	28.23	3.8.23	4.8.23	8.8.23	9.8.23	10.8.23	14.8.23	18.8.23	21.8.23	22.8.23	4.9.23	5.9.23	6.9.23	8.9.23	12.9.23	
1.	SRI RISHITH.R	2301CA10124	P	P	P	P	P	P	P	P	P	P	P	P	P	P	P	P	P	P	P	P	P	P	P	P
2.	S.KABILAN	2301CA10125	P	P	P	P	P	P	P	P	P	P	P	P	P	P	P	P	P	P	P	P	P	P	P	P
3.	SELVA C	2301CA10126	P	P	P	P	P	P	P	P	P	P	P	P	P	P	P	P	P	P	P	P	P	P	P	P
4.	P M JAWAHAR MOHAN	2301CA10127	P	P	P	P	P	P	P	P	P	P	P	P	P	P	P	P	P	P	P	P	P	P	P	P
5.	PRASANTH R	2301CA10128	P	P	P	P	P	P	P	P	P	P	P	P	P	P	P	P	P	P	P	P	P	P	P	P
6.	KUTTY K	2301CA10129	A	P	P	P	P	P	P	P	P	P	P	P	P	P	P	P	P	P	P	P	P	P	P	P
7.	INZAMAM ULHAQ B	2301CA10131	P	P	P	P	P	P	P	P	P	P	P	P	P	P	P	P	P	P	P	P	P	P	P	P
8.	YUVARAJ S	2301CA10132	P	P	P	P	P	P	P	P	P	P	P	P	P	P	P	P	P	P	P	P	P	P	P	P
9.	VENKADESH M	2301CA10133	P	P	P	P	P	P	P	P	P	P	P	P	P	P	P	P	P	P	P	P	P	P	P	P
10.	VIJAY I	2301CA10134	P	P	P	P	P	P	P	P	P	P	P	P	P	P	P	P	P	P	P	P	P	P	P	P
11.	PRAVEEN KUMAR I	2301CA10135	P	P	P	P	P	P	P	P	P	P	P	P	P	P	P	P	P	P	P	P	P	P	P	P
12.	PRAKATHISH R	2301CA10137	P	P	P	P	P	P	P	P	P	P	P	P	P	P	P	P	P	P	P	P	P	P	P	P
13.	IYYAPPAN M	2301CA10138	P	P	P	P	P	P	P	P	P	P	P	P	P	P	P	P	P	P	P	P	P	P	P	P
14.	JERIN M	2301CA10139	P	P	P	P	P	P	P	P	P	P	P	P	P	P	P	P	P	P	P	P	P	P	P	P
15.	AKASH B	2301CA10141	P	P	P	P	P	P	P	P	P	P	P	P	P	P	P	P	P	P	P	P	P	P	P	P

Seen HOD
Department of Computer Science
School of Arts and Science
Ponnaiyah Ramajayam Institute of
Science and Technology (PRIST)
Thanjavur - 613 403.

Seen DEAN
School of Arts & Science
Ponnaiyah Ramajayam Institute of
Science & Technology (PRIST)
Deemed to be University
Vallem, Thanjavur - 613 403.

STUDENTS ATTENDANCE LIST
B.Sc CS/BCA- Diploma course on Web Designing & Hosting
I - BCA

SL NO	Name of the Student	Reg Number	14.9.23	18.9.23	20.9.23	21.9.23	25.9.23	27.9.23	5.10.23	10.10.2	11.10.2	12.10.2	16.10.2	17.10.2	18.10.2	19.10.2	20.10.2	6.11.23	7.11.23	12.12.2	13.12.2	14.12.2	15.12.2	18.12.2	
1.	SRI RISHITH R	2301CA10124	P	P	P	P	P	P	P	P	P	P	P	P	P	P	P	P	P	P	P	P	P	P	P
2.	S.KABILAN	2301CA10125	P	P	P	P	P	P	P	P	P	P	P	P	P	P	P	P	P	P	P	P	P	P	P
3.	SELVA C	2301CA10126	P	P	P	P	P	P	P	P	P	P	P	P	P	P	P	P	P	P	P	P	P	P	P
4.	P M JAWAHAR MOHAN	2301CA10127	P	P	P	P	P	P	P	P	P	P	P	P	P	P	P	P	P	P	P	P	P	P	P
5.	PRASANTH R	2301CA10128	P	P	P	P	P	P	P	P	P	P	P	P	P	P	P	P	P	P	P	P	P	P	P
6.	KUTTY K	2301CA10129	A	P	P	P	P	P	P	P	P	P	P	P	P	P	P	P	P	P	P	P	P	P	P
7.	INZAMAM ULHAQ B	2301CA10131	P	P	P	P	P	P	P	P	P	P	P	P	P	P	P	P	P	P	P	P	P	P	P
8.	YUVARAJ S	2301CA10132	P	P	P	P	P	P	P	P	P	P	P	P	P	P	P	P	P	P	P	P	P	P	P
9.	VENKADESH M	2301CA10133	P	P	P	P	P	P	P	P	P	P	P	P	P	P	P	P	P	P	P	P	P	P	P
10.	VIJAY I	2301CA10134	P	P	P	P	P	P	P	P	P	P	P	P	P	P	P	P	P	P	P	P	P	P	P
11.	PRAVEEN KUMAR I	2301CA10135	P	P	P	P	P	P	P	P	P	P	P	P	P	P	P	P	P	P	P	P	P	P	P
12.	PRAKATHISH R	2301CA10137	P	P	P	P	P	P	P	P	P	P	P	P	P	P	P	P	P	P	P	P	P	P	P
13.	IYYAPPAN M	2301CA10138	P	P	P	P	P	P	P	P	P	P	P	P	P	P	P	P	P	P	P	P	P	P	P
14.	JERIN M	2301CA10139	P	P	P	P	P	P	P	P	P	P	P	P	P	P	P	P	P	P	P	P	P	P	P
15.	AKASH B	2301CA10141	P	P	P	P	P	P	P	P	P	P	P	P	P	P	P	P	P	P	P	P	P	P	P

[Signature]

HOD
 Department of Computer Science
 School of Arts and Science
 Ponnaiyah Ramajayam Institute of
 Science and Technology (PRIST)
 Thanjavur - 613 403.

[Signature]
DEAN

School of Arts & Science
 Ponnaiyah Ramajayam Institute of
 Science & Technology (PRIST)
 Deemed to be University
 Vaikr.m, Thanjavur - 613 403.



**PONNAIYAH RAMAJAYAM INSTITUTE OF
SCIENCE & TECHNOLOGY (PRIST)**

DECLARED AS FILMED TO BE UNIVERSITY
Via 3 of UGC ACT, 1956

STUDENTS ATTENDANCE LIST

B.Sc CS/BCA-Diploma course on AI and ML using pytorch

Sl. NO	Name of the Student	Reg Number	20.7.2	21.7.2	24.7.2	25.7.2	26.7.2	27.7.2	28.7.2	31.7.2	29.23	38.23	48.23	88.23	98.23	108.2	148.2	188.2	218.2	228.2	49.23	59.23	69.23	89.23	129.2
1.	AKASH B	2301CS10168	P	P	P	P	P	P	P	P	P	P	P	P	P	P	P	P	P	P	P	P	P	P	P
2.	JEEVAKAN.K.M	2301CS10170	P	P	P	P	P	P	P	P	P	P	P	P	P	P	P	P	P	P	P	P	P	P	P
3.	RAGUL R	2301CA10143	P	P	P	P	P	P	P	P	P	P	P	P	P	P	P	P	P	P	P	P	P	P	P
4.	SANJAY J	2301CA10144	P	P	P	P	P	P	P	P	P	P	P	P	P	P	P	P	P	P	P	P	P	P	P
5.	RISHIKUMAR T	2301CA10146	P	P	P	P	P	P	P	P	P	P	P	P	P	P	P	P	P	P	P	P	P	P	P
6.	MOHAMMED ASHIQ HUSSIAN A	2301CA10147	A	P	P	P	P	P	P	P	P	P	P	P	P	P	P	P	P	P	P	P	P	P	P
7.	KARTHIK U	2301CA10148	P	P	P	P	P	P	P	P	P	P	P	P	P	P	P	P	P	P	P	P	P	P	P
8.	SANJEEV G	2301CA10149	P	P	P	P	P	P	P	P	P	P	P	P	P	P	P	P	P	P	P	P	P	P	P
9.	ARIHARAN R	2301CA10150	P	P	P	P	P	P	P	P	P	P	P	P	P	P	P	P	P	P	P	P	P	P	P
10.	MATHIALAGAN M	2301CA10151	P	P	P	P	P	P	P	P	P	P	P	P	P	P	P	P	P	P	P	P	P	P	P
11.	BHARATHIRAJA P	2301CA10152	P	P	P	P	P	P	P	P	P	P	P	P	P	P	P	P	P	P	P	P	P	P	P
12.	ABISHEK S	2301CA10153	P	P	P	P	P	P	P	P	A	P	P	P	P	P	P	P	P	P	P	P	P	P	P
13.	ABDUL RAHMAN A	2301CA10154	P	P	P	P	P	P	P	P	P	P	P	P	P	P	P	P	P	P	P	P	P	P	P
14.	VIGNESH V	2301CA10156	P	P	P	P	P	P	P	P	P	P	P	P	P	P	P	P	P	P	P	P	P	P	P
15.	SATHISH P	2301CA10157	P	P	P	P	P	P	P	P	P	P	A	P	P	P	P	P	P	P	P	P	P	P	P

for

HOD
Department of Computer Science
School of Arts and Science
Ponnaiyah Ramajayam Institute of
Science and Technology (PRIST)
Thanjavur - 613 403.

for

Dean
School of Arts & Science
Ponnaiyah Ramajayam Institute of
Science & Technology (PRIST)
Deemed to be University
Vailan, Thanjavur - 613 403.

STUDENTS ATTENDANCE LIST
B.Sc CS/BCA-Diploma course on AI and ML using pytorch

Sl. NO	Name of the Student	Reg. Number	14.9.23	18.9.23	20.9.23	21.9.23	25.9.23	27.9.23	5.10.23	10.10.23	11.10.23	12.10.23	16.10.23	17.10.23	18.10.23	19.10.23	20.10.23	6.11.23	7.11.23	12.12.23	13.12.23	14.12.23	15.12.23	18.12.23	
1.	AKASH B	2301CSI0168	P	P	P	P	P	P	P	P	P	P	P	P	P	P	P	P	P	P	P	P	P	P	P
2.	JEEVAKAN.K.M	2301CSI0170	P	P	P	P	P	P	P	P	P	P	P	P	P	P	P	P	P	P	P	P	P	P	P
3.	RAGUL R	2301CA10143	P	P	P	P	P	P	P	P	P	P	P	P	P	P	P	P	P	P	P	P	P	P	P
4.	SANJAY J	2301CA10144	P	P	P	P	P	P	P	P	P	P	P	P	P	P	P	P	P	P	P	P	P	P	P
5.	RISHIKUMAR T	2301CA10146	P	P	P	P	P	P	P	P	P	P	P	P	P	P	P	P	P	P	P	P	P	P	P
6.	MOHAMMED ASHIQ HUSSIAN A	2301CA10147	A	P	P	P	P	P	P	P	P	P	P	P	P	P	P	P	P	P	P	P	P	P	P
7.	KARTHIK U	2301CA10148	P	P	P	P	P	P	P	P	P	P	P	P	P	P	P	P	P	P	P	P	P	P	P
8.	SANJEEV G	2301CA10149	P	P	P	P	P	P	P	P	P	P	P	P	P	P	P	P	P	P	P	P	P	P	P
9.	ARIHARAN R	2301CA10150	P	P	P	P	P	P	P	P	P	P	P	P	P	P	P	P	P	P	P	P	P	P	P
10.	MATHIYALAGAN M	2301CA10151	P	P	P	P	P	P	P	P	P	P	P	P	P	P	P	P	P	P	P	P	P	P	P
11.	BHARATHIRAJA P	2301CA10152	P	P	P	P	P	P	P	P	P	P	P	P	P	P	P	P	P	P	P	P	P	P	P
12.	ABISHEK S	2301CA10153	P	P	P	P	P	P	P	P	P	P	P	P	P	P	P	P	P	P	P	P	P	P	P
13.	ABDUL RAHMAN A	2301CA10154	P	P	P	P	P	P	P	P	P	P	P	P	P	P	P	P	P	P	P	P	P	P	P
14.	VIGNESH V	2301CA10156	P	P	P	P	P	P	P	P	P	P	P	P	P	P	P	P	P	P	P	P	P	P	P
15.	SATHISH P	2301CA10157	P	P	P	P	P	P	P	P	P	P	P	P	P	P	P	P	P	P	P	P	P	P	P

for

HOD
Department of Computer Science
School of Arts and Science
Fathiyah Ramajayam Institute of
Sciences and Technology (PRIET)
Therip... 613 403.

RS

DEAN
School of Arts & Science
Fathiyah Ramajayam Institute of
Sciences & Technology (PRIET)
Deemed to be University
Vallam, Thanjavur - 613 403



PONNAIYAH RAMAJAYAM INSTITUTE OF
SCIENCE & TECHNOLOGY (PRIST)

Declared as DEEMED-TO-BE-UNIVERSITY
U/s 3 of UGC Act, 1956



CERTIFICATE

THIS IS PRESENTED TO

AKASH B (2301CS10168)

for completing the Certificate / Diploma course on “ AI and ML

using pytorch” From 20/07/2023 To 18/12/2023 In Department of

Computer Science , PRIST University, Thanjavur

K. P. Srinivasan

Coordinator

HOD
Department of Computer Science
School of Arts and Science
Ponnaiyah Ramajayam Institute of
Science and Technology (PRIST)
Thanjavur - 613 403.

DEAN

School of Arts & Science
Ponnaiyah Ramajayam Institute of
Science & Technology (PRIST)
Deemed to be University
Vallam, Thanjavur - 613 403.

Dean



PONNAIYAH RAMAJAYAM INSTITUTE OF
SCIENCE & TECHNOLOGY (PRIST)

Declared as DEEMED-TO-BE-UNIVERSITY
U/s 3 of UGC Act, 1956



CERTIFICATE

THIS IS PRESENTED TO

JEEVAKAN.K.M (2301CS10170)

for completing the Certificate / Diploma course on “ AI and ML

using pytorch” From 20/07/2023 To 18/12/2023 In Department of

Computer Science , PRIST University, Thanjavur

K. Pinnalath

Coordinator

HOD
Department of Computer Science
School of Arts and Science
Ponnaiyah Ramajayam Institute of
Science and Technology (PRIST)
Thanjavur - 613 403.

Dean

DEAN
School of Arts & Science
Ponnaiyah Ramajayam Institute of
Science & Technology (PRIST)
Deemed to be University
Vellam, Thanjavur - 613 403.



PONNAIYAH RAMAJAYAM INSTITUTE OF
SCIENCE & TECHNOLOGY (PRIST)

Declared as DEEMED-TO-BE-UNIVERSITY
U/s 3 of UGC Act, 1956



CERTIFICATE

THIS IS PRESENTED TO

RAGUL R (2301CA10143)

for completing the Certificate / Diploma course on “ AI and ML

using pytorch” From 20/07/2023 To 18/12/2023 In Department of

Computer Science , PRIST University, Thanjavur

K. Prasadhar

Coordinator

[Signature]

HOD

Department of Computer Science
School of Arts and Science
Ponnaiyah Ramajayam Institute of
Science and Technology (PRIST)
Thanjavur - 613 403.

[Signature]

DEAN

School of Arts & Science
Ponnaiyah Ramajayam Institute of
Science & Technology (PRIST)
Deemed to be University
Vallam, Thanjavur - 613 403.

[Signature]

Dean



PONNAIYAH RAMAJAYAM INSTITUTE OF
SCIENCE & TECHNOLOGY (PRIST)

Declared as DEEMED-TO-BE-UNIVERSITY
U/s 3 of UGC Act, 1956



CERTIFICATE

THIS IS PRESENTED TO

SANJAY J (2301CA10144)

for completing the Certificate / Diploma course on “ AI and ML

using pytorch” From 20/07/2023 To 18/12/2023 In Department of

Computer Science , PRIST University, Thanjavur

K. Pinnalathin

Coordinator

[Signature]

HOD

Department of Computer Science
School of Arts and Science
Ponnaiyah Ramajayam Institute of
Science and Technology (PRIST)
Thanjavur - 613 403.

[Signature]

DEAN

School of Arts & Science
Ponnaiyah Ramajayam Institute of
Science & Technology (PRIST)
Deemed to be University
Vallam, Thanjavur - 613 403.

[Signature]

Dean



PONNAIYAH RAMAJAYAM INSTITUTE OF
SCIENCE & TECHNOLOGY (PRIST)

Declared as DEEMED-TO-BE-UNIVERSITY
U/s 3 of UGC Act, 1956



CERTIFICATE

THIS IS PRESENTED TO

RISHIKUMAR T (2301CA10146)

*for completing the Certificate / Diploma course on “ AI and ML
using pytorch” From 20/07/2023 To 18/12/2023 In Department of*

Computer Science , PRIST University, Thanjavur

K. P. Srinivasan

Coordinator

HOD

Department of Computer Science
School of Arts and Science
Ponnaiyah Ramajayam Institute of
Science and Technology (PRIST)
Thanjavur - 613 403.

Dean

DEAN

School of Arts & Science
Ponnaiyah Ramajayam Institute of
Science & Technology (PRIST)
Deemed to be University
Vallam, Thanjavur - 613 403.



PONNAIYAH RAMAJAYAM INSTITUTE OF
SCIENCE & TECHNOLOGY (PRIST)

Declared as DEEMED-TO-BE-UNIVERSITY
U/s 3 of UGC Act, 1956



CERTIFICATE

THIS IS PRESENTED TO

MOHAMMED ASHIQ HUSSIAN A (2301CA101411)

for completing the Certificate / Diploma course on “ AI and ML

using pytorch” From 20/07/2023 To 18/12/2023 In Department of

Computer Science , PRIST University, Thanjavur

K. Pinnalath
Coordinator

HOD
Department of Computer Science
School of Arts and Science
Ponnaiyah Ramajayam Institute of
Science and Technology (PRIST)
Thanjavur - 613 403.

Dean

DEAN
School of Arts & Science
Ponnaiyah Ramajayam Institute of
Science & Technology (PRIST)
Deemed to be University
Vellam, Thanjavur - 613 403.



PONNAIYAH RAMAJAYAM INSTITUTE OF
SCIENCE & TECHNOLOGY (PRIST)

Declared as DEEMED-TO-BE-UNIVERSITY
U/s 3 of UGC Act, 1956



CERTIFICATE

THIS IS PRESENTED TO

KARTHIK U (2301CA10148)

*for completing the Certificate / Diploma course on “ AI and ML
using pytorch” From 20/07/2023 To 18/12/2023 In Department of*

Computer Science , PRIST University, Thanjavur

K. Piuselshu
Coordinator

HOD

Department of Computer Science
School of Arts and Science
Ponnaiyah Ramajayam Institute of
Science and Technology (PRIST)
Thanjavur - 613 403.

Dean

School of Arts & Science
Ponnaiyah Ramajayam Institute of
Science & Technology (PRIST)
Deemed to be University
Vallam, Thanjavur - 613 403.



**PONNAIYAH RAMAJAYAM INSTITUTE OF
SCIENCE & TECHNOLOGY (PRIST)**

Declared as DEEMED-TO-BE-UNIVERSITY
U/s 3 of UGC Act, 1956



CERTIFICATE

THIS IS PRESENTED TO

SANJEEV G (2301CA10149)

for completing the Certificate / Diploma course on “ AI and ML

using pytorch” From 20/07/2023 To 18/12/2023 In Department of

Computer Science , PRIST University, Thanjavur

K. P. ...

Coordinator

[Signature]

HOD

Department of Computer Science
School of Arts and Science
Ponnaiyah Ramajayam Institute of
Science and Technology (PRIST)
Thanjavur - 613 403.

[Signature]

Dean

DEAN

School of Arts & Science
Ponnaiyah Ramajayam Institute of
Science & Technology (PRIST)
Deemed to be University
Vallam, Thanjavur - 613 403.





PONNAIYAH RAMAJAYAM INSTITUTE OF
SCIENCE & TECHNOLOGY (PRIST)

Declared as DEEMED-TO-BE-UNIVERSITY
U/s 3 of UGC Act, 1956



CERTIFICATE

THIS IS PRESENTED TO

ARIHARAN R (2301CA10150)

for completing the Certificate / Diploma course on “ AI and ML

using pytorch” From 20/07/2023 To 18/12/2023 In Department of

Computer Science , PRIST University, Thanjavur

K. Pinnalika

Coordinator

[Signature]

HOD

Department of Computer Science
School of Arts and Science
Ponnaiyah Ramajayam Institute of
Science and Technology (PRIST)
Thanjavur - 613 403.

[Signature]

DEAN

Dean

School of Arts & Science
Ponnaiyah Ramajayam Institute of
Science & Technology (PRIST)
Deemed to be University
Valiam, Thanjavur - 613 403.



PONNAIYAH RAMAJAYAM INSTITUTE OF
SCIENCE & TECHNOLOGY (PRIST)

Declared as DEEMED-TO-BE-UNIVERSITY
U/s 3 of UGC Act, 1956



CERTIFICATE

THIS IS PRESENTED TO

MATHIYALAGAN M (2301CA10151)

for completing the Certificate / Diploma course on “ AI and ML

using pytorch” From 20/07/2023 To 18/12/2023 In Department of

Computer Science , PRIST University, Thanjavur

K. Pinnalaba
Coordinator

[Signature]
HOD
Department of Computer Science
School of Arts and Science
Ponnaiyah Ramajayam Institute of
Science and Technology (PRIST)
Vellam, Thanjavur - 613 403.

[Signature]
Dean

DEAN
School of Arts & Science
Ponnaiyah Ramajayam Institute of
Science & Technology (PRIST)
Deemed to be University
Vellam, Thanjavur - 613 403.



PONNAIYAH RAMAJAYAM INSTITUTE OF
SCIENCE & TECHNOLOGY (PRIST)

Declared as DEEMED-TO-BE-UNIVERSITY
U/s 3 of UGC Act, 1956



CERTIFICATE

THIS IS PRESENTED TO

BHARATHIRAJA P (2301CA10152)

*for completing the Certificate / Diploma course on “ AI and ML
using pytorch” From 20/07/2023 To 18/12/2023 In Department of*

Computer Science , PRIST University, Thanjavur

K. Pinnellathani
Coordinator

[Signature]
HOD
Department of Computer Science
School of Arts and Science
Ponnaiyah Ramajayam Institute of
Science and Technology (PRIST)
Thanjavur - 613 403.

[Signature] *[Signature]*
Dean
DEAN
School of Arts & Science
Ponnaiyah Ramajayam Institute of
Science & Technology (PRIST)
Deemed to be University
Vallam, Thanjavur - 613 403.



PONNAIYAH RAMAJAYAM INSTITUTE OF
SCIENCE & TECHNOLOGY (PRIST)

Declared as DEEMED-TO-BE-UNIVERSITY
U/s 3 of UGC Act, 1956



CERTIFICATE

THIS IS PRESENTED TO

ABISHEK S (2301CA10153)

for completing the Certificate / Diploma course on “ AI and ML

using pytorch” From 20/07/2023 To 18/12/2023 In Department of

Computer Science , PRIST University, Thanjavur

K. Pinnalathin
Coordinator

[Signature]
HOD
Department of Computer Science
Department of Computer Science
School of Arts and Science
Ponnaiyah Ramajayam Institute of
Science and Technology (PRIST)
Thanjavur - 613 403.

[Signature]
DEAN
School of Arts & Science
Ponnaiyah Ramajayam Institute of
Science & Technology (PRIST)
Deemed to be University
Thanjavur - 613 403.

[Signature]
Dean



PONNAIYAH RAMAJAYAM INSTITUTE OF
SCIENCE & TECHNOLOGY (PRIST)

Declared as DEEMED-TO-BE-UNIVERSITY
U/s 3 of UGC Act, 1956



CERTIFICATE

THIS IS PRESENTED TO

ABDUL RAHMAN A (2301CA10154)

*for completing the Certificate / Diploma course on “ AI and ML
using pytorch” From 20/07/2023 To 18/12/2023 In Department of*

Computer Science , PRIST University, Thanjavur

K. P. Prasad
Coordinator

[Signature]
HOD
Department of Computer Science
School of Arts and Science
Ponnaiyah Ramajayam Institute of
Science and Technology (PRIST)
Thanjavur - 613 403.

[Signature] *[Signature]*
Dean
School of Arts & Sci
Ponnaiyah Ramajayam Insti
Science & Technology (PRIST)
Deemed to be University
Vallam, Thanjavur - 613 403.



PONNAIYAH RAMAJAYAM INSTITUTE OF
SCIENCE & TECHNOLOGY (PRIST)

Declared as DEEMED-TO-BE-UNIVERSITY
U/s 3 of UGC Act, 1956

CERTIFICATE

THIS IS PRESENTED TO

VIGNESH V (2301CA10156)



for completing the Certificate / Diploma course on “ AI and ML

using pytorch” From 20/07/2023 To 18/12/2023 In Department of

Computer Science , PRIST University, Thanjavur

K. P. S. S. S.

Coordinator

[Signature]

HOD

Department of Computer Science
School of Arts and Science
Ponnaiyah Ramajayam Institute of
Science and Technology (PRIST)
Thanjavur - 613 403.

[Signature]

Dean

Director
School of Arts & Sci.
Ponnaiyah Ramajayam Insti.
Science & Technology (PRIST)
Deemed to be University
Vallem, Thanjavur - 613 403



**PONNAIYAH RAMAJAYAM INSTITUTE OF
SCIENCE & TECHNOLOGY (PRIST)**

Declared as DEEMED-TO-BE-UNIVERSITY
U/s 3 of UGC Act, 1956

CERTIFICATE

THIS IS PRESENTED TO

SATHISH P (2301CA10157)



for completing the Certificate / Diploma course on “ AI and ML

using pytorch” From 20/07/2023 To 18/12/2023 In Department of

Computer Science , PRIST University, Thanjavur

K. P. Prasad

Coordinator

HOD

Department of Computer Science
School of Arts and Science
Ponnaiyah Ramajayam Institute of
Science and Technology (PRIST)
Thanjavur - 613 403.

Dean

Dean
School of Arts & Science
Ponnaiyah Ramajayam Institute of
Science & Technology (PRIST)
Deemed to be University
Vallam, Thanjavur - 613 403.



PONNAIYAH RAMAJAYAM INSTITUTE OF
SCIENCE & TECHNOLOGY (PRIST)

Declared as DEEMED-TO-BE-UNIVERSITY
U/s 3 of UGC Act, 1956



CERTIFICATE

THIS IS PRESENTED TO

SRIRAM.M (2301CS10132)

for completing the Certificate / Diploma course on “Block

Chain Technology” From 23/01/2024 To 14/03/2024 In Department of

Computer Science , PRIST University, Thanjavur

K. Prasadharan
Coordinator

HOD

Department of Computer Science
School of Arts and Science
Ponnaiyah Ramajayam Institute of
Science and Technology (PRIST)
Thanjavur - 613 403.

DEAN

Dean

School of Arts & Science
Ponnaiyah Ramajayam Institute of
Science & Technology (PRIST)
Deemed to be University
Vellam, Thanjavur - 613 403.



PONNAIYAH RAMAJAYAM INSTITUTE OF
SCIENCE & TECHNOLOGY (PRIST)

Declared as DEEMED-TO-BE-UNIVERSITY
U/s 3 of UGC Act, 1956



CERTIFICATE

THIS IS PRESENTED TO

THIRUMURUGAN.T (2301CS10135)

*for completing the Certificate / Diploma course on “Block
Chain Technology” From 23/01/2024 To 14/03/2024 In Department of
Computer Science , PRIST University, Thanjavur*

K. P. Senthil Kumar
Coordinator

HOD
Department of Computer Science
School of Arts and Science
Ponnaiyah Ramajayam Institute of
Science and Technology (PRIST)
Thanjavur - 613 403.

Dean

DEAN
School of Arts & Science
Ponnaiyah Ramajayam Institute of
Science & Technology (PRIST)
Deemed to be University
Valiam, Thanjavur - 613 403.



PONNAIYAH RAMAJAYAM INSTITUTE OF
SCIENCE & TECHNOLOGY (PRIST)

Declared as DEEMED-TO-BE-UNIVERSITY
U/s 3 of UGC Act, 1956



CERTIFICATE

THIS IS PRESENTED TO

VETHASURYA.S (2301CS10136)

for completing the Certificate / Diploma course on “Block

Chain Technology” From 23/01/2024 To 14/03/2024 In Department of

Computer Science , PRIST University, Thanjavur

K. P. S. S. S.
Coordinator

HOD
Department of Computer Science
School of Arts and Science
Ponnaiyah Ramajayam Institute of
Science and Technology (PRIST)
Thanjavur - 613 403.

de s i n g
Dean

DEAN
School of Arts & Science
Ponnaiyah Ramajayam Institute of
Science & Technology (PRIST)
Deemed to be University
Thanjavur, Thanjavur - 613 403.



PONNAIYAH RAMAJAYAM INSTITUTE OF
SCIENCE & TECHNOLOGY (PRIST)

Declared as DEEMED-TO-BE-UNIVERSITY
U/s 3 of UGC Act, 1956



CERTIFICATE

THIS IS PRESENTED TO

VASANTHA KUMAR.L (2301CS10137)

for completing the Certificate / Diploma course on “Block

Chain Technology” From 23/01/2024 To 14/03/2024 In Department of

Computer Science , PRIST University, Thanjavur

K. P. ...
Coordinator

HOD

Department of Computer Science
School of Arts and Science
Ponnaiyah Ramajayam Institute of
Science and Technology (PRIST)
Thanjavur - 613 403.

Dean

DEAN

School of Arts & Science
Ponnaiyah Ramajayam Institute of
Science & Technology (PRIST)
Deemed to be University
Valiam, Thanjavur - 613 403.



PONNAIYAH RAMAJAYAM INSTITUTE OF
SCIENCE & TECHNOLOGY (PRIST)

Declared as DEEMED-TO-BE-UNIVERSITY
U/s 3 of UGC Act, 1956



CERTIFICATE

THIS IS PRESENTED TO

VIGNESHWARAN.B (2301CS10138)

for completing the Certificate / Diploma course on “Block

Chain Technology” From 23/01/2024 To 14/03/2024 In Department of

Computer Science , PRIST University, Thanjavur

K. Prasadharan
Coordinator

HOD

Department of Computer Science
School of Arts and Science
Ponnaiyah Ramajayam Institute of
Science and Technology (PRIST)
Thanjavur - 613 403.

Dean

DEAN

School of Arts & Science
Ponnaiyah Ramajayam Institute of
Science & Technology (PRIST)
Deemed to be University
Valiam, Thanjavur - 613 403.



PONNAIYAH RAMAJAYAM INSTITUTE OF
SCIENCE & TECHNOLOGY (PRIST)

Declared as DEEMED-TO-BE-UNIVERSITY
U/s 3 of UGC Act, 1956



CERTIFICATE

THIS IS PRESENTED TO

RAKESH.K (2301CS10139)

for completing the Certificate / Diploma course on “Block

Chain Technology” From 23/01/2024 To 14/03/2024 In Department of

Computer Science , PRIST University, Thanjavur

K. Pinnalatha
Coordinator

HOD

Department of Computer Science
School of Arts and Science
Ponnaiyah Ramajayam Institute of
Science and Technology (PRIST)
Thanjavur - 613 403.

Deivy King
Dean

DEAN

School of Arts & Science
Ponnaiyah Ramajayam Institute of
Science & Technology (PRIST)
Deemed to be University
Vallam, Thanjavur - 613 403.



PONNAIYAH RAMAJAYAM INSTITUTE OF
SCIENCE & TECHNOLOGY (PRIST)

Declared as DEEMED-TO-BE-UNIVERSITY
U/s 3 of UGC Act, 1956



CERTIFICATE

THIS IS PRESENTED TO

MADESH.S (2301CS10140)

for completing the Certificate / Diploma course on “Block

Chain Technology” From 23/01/2024 To 14/03/2024 In Department of

Computer Science , PRIST University, Thanjavur

K. Prasad
Coordinator

HOD

Department of Computer Science
School of Arts and Science
Ponnaiyah Ramajayam Institute of
Science and Technology (PRIST)
Thanjavur - 613 403.

Dean

DEAN

School of Arts & Science
Ponnaiyah Ramajayam Institute of
Science & Technology (PRIST)
Deemed to be University
Valiam, Thanjavur - 613 403.



PONNAIYAH RAMAJAYAM INSTITUTE OF
SCIENCE & TECHNOLOGY (PRIST)

Declared as DEEMED-TO-BE-UNIVERSITY
U/s 3 of UGC Act, 1956



CERTIFICATE

THIS IS PRESENTED TO

VIJAYAKUMAR.M (2301CS10143)

for completing the Certificate / Diploma course on “Block

Chain Technology” From 23/01/2024 To 14/03/2024 In Department of

Computer Science , PRIST University, Thanjavur

K. P. ...
Coordinator

HOD
Department of Computer Science
School of Arts and Science
Ponnaiyah Ramajayam Institute of
Science and Technology (PRIST)
Thanjavur - 613 403.

...
Dean

DEAN
School of Arts & Science
Ponnaiyah Ramajayam Institute of
Science & Technology (PRIST)
Deemed to be University
Vallam, Thanjavur - 613 403.



PONNAIYAH RAMAJAYAM INSTITUTE OF
SCIENCE & TECHNOLOGY (PRIST)

Declared as DEEMED-TO-BE-UNIVERSITY
U/s 3 of UGC Act, 1956



CERTIFICATE

THIS IS PRESENTED TO

RAHUL.S (2301CS10148)

for completing the Certificate / Diploma course on “Block

Chain Technology” From 23/01/2024 To 14/03/2024 In Department of

Computer Science , PRIST University, Thanjavur

K. P. *P. Prasad*
Coordinator

HOD

Department of Computer Science
School of Arts and Science
Ponnaiyah Ramajayam Institute of
Science and Technology (PRIST)
Thanjavur - 613 403.

[Handwritten signature]
Dean

DEAN

School of Arts & Science
Ponnaiyah Ramajayam Institute of
Science & Technology (PRIST)
Deemed to be University
Vallam, Thanjavur - 613 403.



PONNAIYAH RAMAJAYAM INSTITUTE OF
SCIENCE & TECHNOLOGY (PRIST)

Declared as DEEMED-TO-BE-UNIVERSITY
U/s 3 of UGC Act, 1956



CERTIFICATE

THIS IS PRESENTED TO

NAGULAN.V (2301CS10149)

for completing the Certificate / Diploma course on “Block

Chain Technology” From 23/01/2024 To 14/03/2024 In Department of

Computer Science , PRIST University, Thanjavur

K. Pinnalibus
Coordinator

HOD
Department of Computer Science
School of Arts and Science
Ponnaiyah Ramajayam Institute of
Science and Technology (PRIST)
Thanjavur - 613 403.

[Handwritten signature]
Dean

DEAN
School of Arts & Science
Ponnaiyah Ramajayam Institute of
Science & Technology (PRIST)
Deemed to be University
Vallam, Thanjavur - 613 403.



PONNAIYAH RAMAJAYAM INSTITUTE OF
SCIENCE & TECHNOLOGY (PRIST)

Declared as DEEMED-TO-BE UNIVERSITY
U/s 3 of UGC Act, 1956



CERTIFICATE

THIS IS PRESENTED TO

EASWAR.S (2301CS10151)

for completing the Certificate / Diploma course on “Block

Chain Technology” From 23/01/2024 To 14/03/2024 In Department of

Computer Science , PRIST University, Thanjavur

K. P. ...
Coordinator

HOD
Department of Computer Science
School of Arts and Science
Ponnaiyah Ramajayam Institute of
Science and Technology (PRIST)
Thanjavur - 613 403.

Dean

DEAN
School of Arts & Science
Ponnaiyah Ramajayam Institute of
Science & Technology (PRIST)
Deemed to be University
Vallam, Thanjavur - 613 403.



PONNAIYAH RAMAJAYAM INSTITUTE OF
SCIENCE & TECHNOLOGY (PRIST)

Declared as DEEMED-TO-BE-UNIVERSITY
U/s 3 of UGC Act, 1956



CERTIFICATE

THIS IS PRESENTED TO

MUTHUSELVAN.S (2301CS10152)

for completing the Certificate / Diploma course on “Block

Chain Technology” From 23/01/2024 To 14/03/2024 In Department of

Computer Science , PRIST University, Thanjavur

K. P. ...
Coordinator

HOD
Department of Computer Science
School of Arts and Science
Ponnaiyah Ramajayam Institute of
Science and Technology (PRIST)
Thanjavur - 613 403.

Dean

DEAN
School of Arts & Science
Ponnaiyah Ramajayam Institute of
Science & Technology (PRIST)
Deemed to be University
Valiam, Thanjavur - 613 403.



PONNAIYAH RAMAJAYAM INSTITUTE OF
SCIENCE & TECHNOLOGY (PRIST)

Declared as DEEMED-TO-BE-UNIVERSITY
U/s 3 of UGC Act, 1956



CERTIFICATE

THIS IS PRESENTED TO

SANTHOSH KUMAR.L (2301CS10153)

for completing the Certificate / Diploma course on “Block

Chain Technology” From 23/01/2024 To 14/03/2024 In Department of

Computer Science , PRIST University, Thanjavur

K. Prasad Kumar
Coordinator

HOD
Department of Computer Science
School of Arts and Science
Ponnaiyah Ramajayam Institute of
Science and Technology (PRIST)
Thanjavur - 613 403.

Devin King
Dean

DEAN
School of Arts & Science
Ponnaiyah Ramajayam Institute of
Science & Technology (PRIST)
Deemed to be University
Vallam, Thanjavur - 613 403.



PONNAIYAH RAMAJAYAM INSTITUTE OF
SCIENCE & TECHNOLOGY (PRIST)

Declared as DEEMED-TO-BE-UNIVERSITY
U/s 3 of UGC Act, 1956



CERTIFICATE

THIS IS PRESENTED TO

VALLARASU.D (2301CS10155)

for completing the Certificate / Diploma course on “Block

Chain Technology” From 23/01/2024 To 14/03/2024 In Department of

Computer Science , PRIST University, Thanjavur

K. Prasadharan 
Coordinator

HOD

Department of Computer Science
School of Arts and Science
Ponnaiyah Ramajayam Institute of
Science and Technology (PRIST)
Thanjavur - 613 403.



Dean

DEAN
School of Arts & Science
Ponnaiyah Ramajayam Institute of
Science & Technology (PRIST)
Deemed to be University
Vallam, Thanjavur - 613 403.



PONNAIYAH RAMAJAYAM INSTITUTE OF
SCIENCE & TECHNOLOGY (PRIST)

Declared as DEEMED-TO-BE-UNIVERSITY
U/s 3 of UGC Act, 1956



CERTIFICATE

THIS IS PRESENTED TO

SENTHAN.A (2301CS10157)

for completing the Certificate / Diploma course on “Block

Chain Technology” From 23/01/2024 To 14/03/2024 In Department of

Computer Science , PRIST University, Thanjavur

K. Pinnalathin
Coordinator

HOD
Department of Computer Science
School of Arts and Science
Ponnaiyah Ramajayam Institute of
Science and Technology (PRIST)
Thanjavur - 613 403.

[Signature]
Dean

DEAN
School of Arts & Science
Ponnaiyah Ramajayam Institute of
Science & Technology (PRIST)
Deemed to be University
Vallam, Thanjavur - 613 403.



PONNAIYAH RAMAJAYAM INSTITUTE OF
SCIENCE & TECHNOLOGY (PRIST)

Declared as DEEMED-TO-BE-UNIVERSITY
U/s 3 of UGC Act, 1956



CERTIFICATE

THIS IS PRESENTED TO

SENTHAMIZHAN.S (2301CS10158)

for completing the Certificate / Diploma course on “Block

Chain Technology” From 23/01/2024 To 14/03/2024 In Department of

Computer Science , PRIST University, Thanjavur

K. P. Senthil Kumar
Coordinator
HOD

Department of Computer Science
School of Arts and Science
Ponnaiyah Ramajayam Institute of
Science and Technology (PRIST)
Thanjavur - 613 403.

[Signature]
Dean

DEAN
School of Arts & Science
Ponnaiyah Ramajayam Institute of
Science & Technology (PRIST)
Deemed to be University
Vallam, Thanjavur - 613 403.



PONNAIYAH RAMAJAYAM INSTITUTE OF
SCIENCE & TECHNOLOGY (PRIST)

Declared as DEEMED-TO-BE-UNIVERSITY
U/s 3 of UGC Act, 1956



CERTIFICATE

THIS IS PRESENTED TO

SATHISH.S (2301CS10160)

for completing the Certificate / Diploma course on “Block

Chain Technology” From 23/01/2024 To 14/03/2024 In Department of

Computer Science , PRIST University, Thanjavur

K. P. ...
Coordinator
HOD

Department of Computer Science
School of Arts and Science
Ponnaiyah Ramajayam Institute of
Science and Technology (PRIST)
Thanjavur - 613 403.

...
Dean

DEAN
School of Arts & Science
Ponnaiyah Ramajayam Institute of
Science & Technology (PRIST)
Deemed to be University
Vattam, Thanjavur - 613 403.



PONNAIYAH RAMAJAYAM INSTITUTE OF
SCIENCE & TECHNOLOGY (PRIST)

Declared as DEEMED-TO-BE-UNIVERSITY
U/s 3 of UGC Act, 1956



CERTIFICATE

THIS IS PRESENTED TO

MUKILAN.R (2301CS10161)

for completing the Certificate / Diploma course on “Block

Chain Technology” From 23/01/2024 To 14/03/2024 In Department of

Computer Science , PRIST University, Thanjavur

K. Prasad
Coordinator

HOD
Department of Computer Science
School of Arts and Science
Ponnaiyah Ramajayam Institute of
Science and Technology (PRIST)
Thanjavur - 613 403.

[Signature]
Dean

DEAN
School of Arts & Science
Ponnaiyah Ramajayam Institute of
Science & Technology (PRIST)
Deemed to be University
Vellam, Thanjavur - 613 403.



PONNAIYAH RAMAJAYAM INSTITUTE OF
SCIENCE & TECHNOLOGY (PRIST)

Declared as DEEMED-TO-BE-UNIVERSITY
U/s 3 of UGC Act, 1956



CERTIFICATE

THIS IS PRESENTED TO

THINAKARAN.T (2301CS10162)

for completing the Certificate / Diploma course on “Block

Chain Technology” From 23/01/2024 To 14/03/2024 In Department of

Computer Science , PRIST University, Thanjavur

K. P. Prasad

Coordinator

HOD

Department of Computer Science
School of Arts and Science
Ponnaiyah Ramajayam Institute of
Science and Technology (PRIST)
Thanjavur - 613 403.

[Signature]

DEAN

School of Arts & Science
Ponnaiyah Ramajayam Institute of
Science & Technology (PRIST)
Deemed to be University
Vallam, Thanjavur - 613 403.

[Signature]

Dean



PONNAIYAH RAMAJAYAM INSTITUTE OF
SCIENCE & TECHNOLOGY (PRIST)

Declared as DEEMED-TO-BE-UNIVERSITY
U/s 3 of UGC Act, 1956



CERTIFICATE

THIS IS PRESENTED TO

DINAMATHAN.T (2301CS10163)

for completing the Certificate / Diploma course on “Block

Chain Technology” From 23/01/2024 To 14/03/2024 In Department of

Computer Science , PRIST University, Thanjavur

K. Prasad
Coordinator

Department of Computer Science
School of Arts and Science
Ponnaiyah Ramajayam Institute of
Science and Technology (PRIST)
Thanjavur - 613 403.

[Signature]

Dean

DEAN
School of Arts & Science
Ponnaiyah Ramajayam Institute of
Science & Technology (PRIST)
Deemed to be University
Vallam, Thanjavur - 613 403.



PONNAIYAH RAMAJAYAM INSTITUTE OF
SCIENCE & TECHNOLOGY (PRIST)

Declared as DEEMED-TO-BE-UNIVERSITY
U/s 3 of UGC Act, 1956



CERTIFICATE

THIS IS PRESENTED TO

GURUJI.K (2301CS10164)

for completing the Certificate / Diploma course on “Block

Chain Technology” From 23/01/2024 To 14/03/2024 In Department of

Computer Science , PRIST University, Thanjavur

K. Praveen Kumar
Coordinator
Department of Computer Science
School of Arts and Science
Ponnaiyah Ramajayam Institute of
Science and Technology (PRIST)
Thanjavur - 613 403.

[Signature]
Dean
DEAN
School of Arts & Science
Ponnaiyah Ramajayam Institute of
Science & Technology (PRIST)
Deemed to be University
Valiam, Thanjavur - 613 403.



PONNAIYAH RAMAJAYAM INSTITUTE OF
SCIENCE & TECHNOLOGY (PRIST)

Declared as DEEMED-TO-BE-UNIVERSITY
U/s 3 of UGC Act, 1956



CERTIFICATE

THIS IS PRESENTED TO

ASHWIN.S (2301CS10165)

for completing the Certificate / Diploma course on “Block

Chain Technology” From 23/01/2024 To 14/03/2024 In Department of

Computer Science , PRIST University, Thanjavur

K. P. ...
Coordinator

HOD

Department of Computer Science
School of Arts and Science
Ponnaiyah Ramajayam Institute of
Science and Technology (PRIST)
Thanjavur - 613 403.

Dean

Dean

DEAN
School of Arts & Science
Ponnaiyah Ramajayam Institute of
Science & Technology (PRIST)
Deemed to be University
Vallam, Thanjavur - 613 403.



PONNAIYAH RAMAJAYAM INSTITUTE OF
SCIENCE & TECHNOLOGY (PRIST)

Declared as DEEMED-TO-BE-UNIVERSITY
U/s 3 of UGC Act, 1956



CERTIFICATE

THIS IS PRESENTED TO

VIVIN P (2301CS10166)

for completing the Certificate / Diploma course on “Block

Chain Technology” From 23/01/2024 To 14/03/2024 In Department of

Computer Science , PRIST University, Thanjavur

K. Prasadharan
Coordinator

HOD
Department of Computer Science
School of Arts and Science
Ponnaiyah Ramajayam Institute of
Science and Technology (PRIST)
Thanjavur - 613 403.

Dr. S. S. Srinivasan
Dean

DEAN
School of Arts & Science
Ponnaiyah Ramajayam Institute of
Science & Technology (PRIST)
Deemed to be University
Vallam, Thanjavur - 613 403.



PONNAIYAH RAMAJAYAM INSTITUTE OF
SCIENCE & TECHNOLOGY (PRIST)

Declared as DEEMED-TO-BE-UNIVERSITY
U/s 3 of UGC Act, 1956



CERTIFICATE

THIS IS PRESENTED TO

ARULSAMINATHAN R (2301CS10167)

for completing the Certificate / Diploma course on “Block

Chain Technology” From 23/01/2024 To 14/03/2024 In Department of

Computer Science , PRIST University, Thanjavur

K. Prasad
Coordinator

HOD
Department of Computer Science
School of Arts and Science
Ponnaiyah Ramajayam Institute of
Science and Technology (PRIST)
Thanjavur - 613 403.

Deen
DEAN
Dean

School of Arts & Science
Ponnaiyah Ramajayam Institute of
Science & Technology (PRIST)
Deemed to be University
Vallam, Thanjavur - 613 403.



PONNAIYAH RAMAJAYAM INSTITUTE OF
SCIENCE & TECHNOLOGY (PRIST)

Declared as DEEMED-TO-BE-UNIVERSITY
U/s 3 of UGC Act, 1956



CERTIFICATE

THIS IS PRESENTED TO

JANAKI.J (2301CS10201)

for completing the Certificate / Diploma course on “Block

Chain Technology” From 23/01/2024 To 14/03/2024 In Department of

Computer Science , PRIST University, Thanjavur

K. P. Prasad
Coordinator

HOD
Department of Computer Science
School of Arts and Science
Ponnaiyah Ramajayam Institute of
Science and Technology (PRIST)
Thanjavur - 613 403.

Shirley King
Dean

DEAN
School of Arts & Science
Ponnaiyah Ramajayam Institute of
Science & Technology (PRIST)
Deemed to be University
Vallam, Thanjavur - 613 403.



PONNAIYAH RAMAJAYAM INSTITUTE OF
SCIENCE & TECHNOLOGY (PRIST)

Declared as DEEMED-TO-BE-UNIVERSITY
U/s 3 of UGC Act, 1956



CERTIFICATE

THIS IS PRESENTED TO

BHUVANESHWARI.R (2301CS10202)

for completing the Certificate / Diploma course on “Block

Chain Technology” From 23/01/2024 To 14/03/2024 In Department of

Computer Science , PRIST University, Thanjavur

K. P. Prasad
Coordinator

Department of Computer Science
School of Arts and Science
Ponnaiyah Ramajayam Institute of
Science and Technology (PRIST)
Thanjavur - 613 403.

[Signature]
Dean

DEAN
School of Arts & Science
Ponnaiyah Ramajayam Institute of
Science & Technology (PRIST)
Deemed to be University
Vallam, Thanjavur - 613 403.



PONNAIYAH RAMAJAYAM INSTITUTE OF
SCIENCE & TECHNOLOGY (PRIST)

Declared as DEEMED-TO-BE-UNIVERSITY
U/s 3 of UGC Act, 1956



CERTIFICATE

THIS IS PRESENTED TO

KABILAN M (2301CA10102)

for completing the Certificate / Diploma course on “Block

Chain Technology” From 23/01/2024 To 14/03/2024 In Department of

Computer Science , PRIST University, Thanjavur

K. P. Prasad
Coordinator
HOD

Department of Computer Science
School of Arts and Science
Ponnaiyah Ramajayam Institute of
Science and Technology (PRIST)
Thanjavur - 613 403.

[Signature]
Dean

DEAN
School of Arts & Science
Ponnaiyah Ramajayam Institute of
Science & Technology (PRIST)
Deemed to be University
Vallam, Thanjavur - 613 403.



PONNAIYAH RAMAJAYAM INSTITUTE OF
SCIENCE & TECHNOLOGY (PRIST)

Declared as DEEMED-TO-BE-UNIVERSITY
U/s 3 of UGC Act, 1956



CERTIFICATE

THIS IS PRESENTED TO

SHARUKESH K (2301CA10103)

*for completing the Certificate / Diploma course on “Block
Chain Technology” From 23/01/2024 To 14/03/2024 In Department of
Computer Science , PRIST University, Thanjavur*

K. P. ...
Coordinator

HOD
Department of Computer Science
School of Arts and Science
Ponnaiyah Ramajayam Institute of
Science and Technology (PRIST)
Thanjavur - 613 403.

...

DEAN **Dean**

School of Arts & Science
Ponnaiyah Ramajayam Institute of
Science & Technology (PRIST)
Deemed to be University
Valiam, Thanjavur - 613 403.



PONNAIYAH RAMAJAYAM INSTITUTE OF
SCIENCE & TECHNOLOGY (PRIST)

Declared as DEEMED-TO-BE-UNIVERSITY
U/s 3 of UGC Act, 1956



CERTIFICATE

THIS IS PRESENTED TO

AJAY R (2301CA10104)

for completing the Certificate / Diploma course on “Block

Chain Technology” From 23/01/2024 To 14/03/2024 In Department of

Computer Science , PRIST University, Thanjavur

K. P. Srinivasan
Coordinator
HOD

Department of Computer Science
School of Arts and Science
Ponnaiyah Ramajayam Institute of
Science and Technology (PRIST)
Thanjavur - 613 403.

[Signature]
Dean

DEAN
School of Arts & Science
Ponnaiyah Ramajayam Institute of
Science & Technology (PRIST)
Deemed to be University
Vallam, Thanjavur - 613 403.



PONNAIYAH RAMAJAYAM INSTITUTE OF
SCIENCE & TECHNOLOGY (PRIST)

Declared as DEEMED-TO-BE-UNIVERSITY
U/s 3 of UGC Act, 1956



CERTIFICATE

THIS IS PRESENTED TO

JEEVA R (2301CA10105)

for completing the Certificate / Diploma course on “Block

Chain Technology” From 23/01/2024 To 14/03/2024 In Department of

Computer Science , PRIST University, Thanjavur

K. P. Prasad
Coordinator

HOD
Department of Computer Science
School of Arts and Science
Ponnaiyah Ramajayam Institute of
Science and Technology (PRIST)
Thanjavur - 613 403.

[Signature]
Dean

DEAN
School of Arts & Science
Ponnaiyah Ramajayam Institute
of Science & Technology (PRIST)
Deemed to be University
Vallam, Thanjavur - 613 403.



PONNAIYAH RAMAJAYAM INSTITUTE OF
SCIENCE & TECHNOLOGY (PRIST)

Declared as DEEMED-TO-BE-UNIVERSITY
U/s 3 of UGC Act, 1956



CERTIFICATE

THIS IS PRESENTED TO

AKASH MUTHU (2301CA10106)

for completing the Certificate / Diploma course on “Block

Chain Technology” From 23/01/2024 To 14/03/2024 In Department of

Computer Science , PRIST University, Thanjavur

K. Pinnalathar
Coordinator

HOD

Department of Computer Science
School of Arts and Science
Ponnaiyah Ramajayam Institute of
Science and Technology (PRIST)
Thanjavur - 613 403,

[Signature]
Dean

DEAN

School of Arts & Science
Ponnaiyah Ramajayam Institute of
Science & Technology (PRIST)
Deemed to be University
Vallam, Thanjavur - 613 403.



PONNAIYAH RAMAJAYAM INSTITUTE OF
SCIENCE & TECHNOLOGY (PRIST)

Declared as DEEMED-TO-BE-UNIVERSITY
U/s 3 of UGC Act, 1956



CERTIFICATE

THIS IS PRESENTED TO

N.ARUN (2101CA10131)

for completing the Certificate / Diploma course on “Android

App Development” From 17/07/2023 To 13/09/2023 In Department of

Computer Science , PRIST University, Thanjavur

K. Pinnalathar

Coordinator

[Signature]

HOD

Department of Computer Science
School of Arts and Science
Ponnaiyah Ramajayam Institute of
Science and Technology (PRIST)
Thanjavur - 613 403.

[Signature]

DEAN

Dean

School of Arts & Science
Ponnaiyah Ramajayam Institute of
Science & Technology (PRIST)
Deemed to be University
Vellur, n. Thanjavur - 613 403.



PONNAIYAH RAMAJAYAM INSTITUTE OF
SCIENCE & TECHNOLOGY (PRIST)

Declared as DEEMED-TO-BE-UNIVERSITY
U/s 3 of UGC Act, 1956



CERTIFICATE

THIS IS PRESENTED TO

M.VIJAY (2101CA10132)

for completing the Certificate / Diploma course on “Android

App Development” From 17/07/2023 To 13/09/2023 In Department of

Computer Science , PRIST University, Thanjavur

K. Pinnalathu

Coordinator

HOD

Department of Computer Science
School of Arts and Science
Ponnaiyah Ramajayam Institute of
Science and Technology (PRIST)
Thanjavur - 613 403.

DEAN

Dean

School of Arts & Science
Ponnaiyah Ramajayam Institute of
Science & Technology (PRIST)
Deemed to be University
Vailam, Thanjavur - 613 403.





PONNAIYAH RAMAJAYAM INSTITUTE OF
SCIENCE & TECHNOLOGY (PRIST)

Declared as DEEMED-TO-BE-UNIVERSITY
U/s 3 of UGC Act, 1956



CERTIFICATE

THIS IS PRESENTED TO

ST DINESH (2101CA10133)

for completing the Certificate / Diploma course on “Android

App Development” From 17/07/2023 To 13/09/2023 In Department of

Computer Science , PRIST University, Thanjavur

K. P. Prasad

Coordinator

[Signature]

HOD

Department of Computer Science
School of Arts and Science
Ponnaiyah Ramajayam Institute of
Science and Technology (PRIST)
Thanjavur - 613 403.

[Signature]

DEAN

Dean

School of Arts & Science
Ponnaiyah Ramajayam Institute of
Science & Technology (PRIST)
Deemed to be University
Vallam, Thanjavur - 613 403.



PONNAIYAH RAMAJAYAM INSTITUTE OF
SCIENCE & TECHNOLOGY (PRIST)

Declared as DEEMED-TO-BE-UNIVERSITY
U/s 3 of UGC Act, 1956



CERTIFICATE

THIS IS PRESENTED TO
R A RISHI RAJAN (2101CA10134)

for completing the Certificate / Diploma course on “Android

App Development” From 17/07/2023 To 13/09/2023 In Department of

Computer Science , PRIST University, Thanjavur

K. P. Prasad

Coordinator

HOD
Department of Computer Science
School of Arts and Science
Ponnaiyah Ramajayam Institute of
Science and Technology (PRIST)
Thanjavur - 613 403.

Dean

DEAN
School of Arts & Science
Ponnaiyah Ramajayam Institute of
Science & Technology (PRIST)
Deemed to be University
Vallam, Thanjavur - 613 403.



PONNAIYAH RAMAJAYAM INSTITUTE OF
SCIENCE & TECHNOLOGY (PRIST)

Declared as DEEMED-TO-BE-UNIVERSITY
U/s 3 of UGC Act, 1956



CERTIFICATE

THIS IS PRESENTED TO

K.N.MADHAVA KANNAN (2101CA10135,

for completing the Certificate / Diploma course on “Android

App Development” From 17/07/2023 To 13/09/2023 In Department of

Computer Science , PRIST University, Thanjavur

K. P. Srinivasan

Coordinator

[Signature]

HOD
Department of Computer Science
School of Arts and Science
Ponnaiyah Ramajayam Institute of
Science and Technology (PRIST)
Thanjavur - 613 403

[Signature]

Dean

DEAN
School of Arts & Science
Ponnaiyah Ramajayam Institute of
Science & Technology (PRIST)
Deemed to be University
Thanjavur - 613 403.

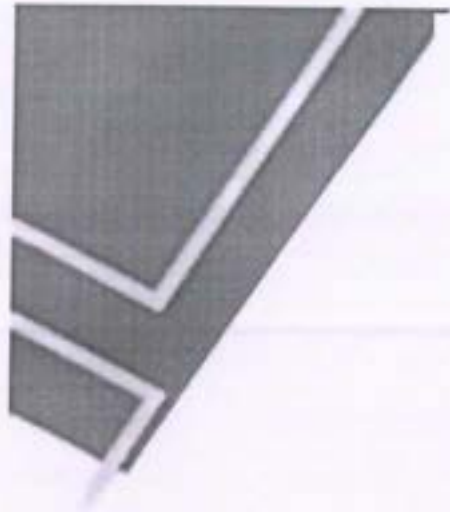

**PONNAIYAH RAMAJAYAM INSTITUTE OF
SCIENCE & TECHNOLOGY (PRIST)**

Declared as DEEMED-TO-BE-UNIVERSITY
U/s 3 of UGC Act, 1956



CERTIFICATE

THIS IS PRESENTED TO

A.SWAMINATHAN (2101CA10136)

for completing the Certificate / Diploma course on “Android

App Development” From 17/07/2023 To 13/09/2023 In Department of

Computer Science , PRIST University, Thanjavur

K. P. Prasad

Coordinator

HOD
Department of Computer Science
School of Arts and Science
Ponnaiyah Ramajayam Institute of
Science and Technology (PRIST)
Thanjavur - 613 403

DEAN

Dean

School of Arts & Science
Ponnaiyah Ramajayam Institute of
Science & Technology (PRIST)
Deemed to be University
Thanjavur - 613 403.



PONNAIYAH RAMAJAYAM INSTITUTE OF
SCIENCE & TECHNOLOGY (PRIST)

Declared as DEEMED-TO-BE-UNIVERSITY
U/s 3 of UGC Act, 1956



CERTIFICATE

THIS IS PRESENTED TO

M.VEMBARASAN (2101CA10137)

for completing the Certificate / Diploma course on “Android

App Development” From 17/07/2023 To 13/09/2023 In Department of

Computer Science , PRIST University, Thanjavur

K. P. Prasad

Coordinator

HOD
Department of Computer Science
School of Arts & Science
Ponnaiyah Ramajayam Institute of
Science and Technology (PRIST)
Thanjavur - 613 403.

DEAN

Dean

School of Arts & Science
Ponnaiyah Ramajayam Institute of
Science & Technology (PRIST)
Deemed to be University
Valmiki, Thanjavur - 613 403.



PONNAIYAH RAMAJAYAM INSTITUTE OF
SCIENCE & TECHNOLOGY (PRIST)

Declared as DEEMED-TO-BE-UNIVERSITY
U/s 3 of UGC Act, 1956



CERTIFICATE

THIS IS PRESENTED TO

S.ARULRAJ (2101CA10138)

for completing the Certificate / Diploma course on “Android

App Development” From 17/07/2023 To 13/09/2023 In Department of

Computer Science , PRIST University, Thanjavur

K. Ponnaiyah

Coordinator

HOD
Department of Computer Science
School of Arts and Science
Ponnaiyah Ramajayam Institute of
Science and Technology (PRIST)
Thanjavur - 613 403.

Dean

DEAN
School of Arts & Science
Ponnaiyah Ramajayam Institute of
Science & Technology (PRIST)
Deemed to be University
Thanjavur - 613 403.



PONNAIYAH RAMAJAYAM INSTITUTE OF
SCIENCE & TECHNOLOGY (PRIST)

Declared as DEEMED-TO-BE-UNIVERSITY
U/s 3 of UGC Act, 1956



CERTIFICATE

THIS IS PRESENTED TO

K.SIVA (2101CA10139)

for completing the Certificate / Diploma course on “Android

App Development” From 17/07/2023 To 13/09/2023 In Department of

Computer Science , PRIST University, Thanjavur

K. P. Sivasubramanian

Coordinator

HOD
Department of Computer Science
School of Arts and Science
Ponnaiyah Ramajayam Institute of
Science and Technology (PRIST)
Thanjavur

Dean

DEAN
School of Arts & Science
Ponnaiyah Ramajayam Institute of
Science & Technology (PRIST)
Deemed to be University
Vallam, Thanjavur - 613 403.



PONNAIYAH RAMAJAYAM INSTITUTE OF
SCIENCE & TECHNOLOGY (PRIST)

Declared as DEEMED-TO-BE-UNIVERSITY
U/s 3 of UGC Act, 1956



CERTIFICATE

THIS IS PRESENTED TO

S.NANTHAKUMAR (2101CA10140)

for completing the Certificate / Diploma course on “Android

App Development” From 17/07/2023 To 13/09/2023 In Department of

Computer Science , PRIST University, Thanjavur

K. Pinnalath

Coordinator

HOD
Department of Computer Science
School of Arts and Science
Ponnaiyah Ramajayam Institute of
Science and Technology (PRIST)
Thanjavur - 613 403.

Dean

DEAN
School of Arts & Science
Ponnaiyah Ramajayam Institute of
Science & Technology (PRIST)
Deemed to be University
Thanjavur - 613 403.



PONNAIYAH RAMAJAYAM INSTITUTE OF
SCIENCE & TECHNOLOGY (PRIST)

Declared as DEEMED-TO-BE-UNIVERSITY
U/s 3 of UGC Act, 1956



CERTIFICATE

THIS IS PRESENTED TO

K.SANJAI KANNAN (2101CA10141)

for completing the Certificate / Diploma course on “Android

App Development” From 17/07/2023 To 13/09/2023 In Department of

Computer Science , PRIST University, Thanjavur

K. P. Prasad

Coordinator

HOD
Department of Computer Science
School of Arts and Science
Ponnaiyah Ramajayam Institute of
Science and Technology (PRIST)
Thanjavur - 613 403.

Dean

DEAN
School of Arts & Science
Ponnaiyah Ramajayam Institute of
Science & Technology (PRIST)
Deemed to be University
Vallam, Thanjavur - 613 403.



PONNAIYAH RAMAJAYAM INSTITUTE OF
SCIENCE & TECHNOLOGY (PRIST)

Declared as DEEMED-TO-BE-UNIVERSITY
U/s 3 of UGC Act, 1956



CERTIFICATE

THIS IS PRESENTED TO

D.JAGADEESAN (2101CA10142)

for completing the Certificate / Diploma course on “Android

App Development” From 17/07/2023 To 13/09/2023 In Department of

Computer Science , PRIST University, Thanjavur

K. Prasad

Coordinator

HOD
Department of Computer Science
School of Arts and Science
Ponnaiyah Ramajayam Institute of
Science and Technology (PRIST)
Thanjavur - 613 403.

Dean

DEAN
School of Arts & Science
Ponnaiyah Ramajayam Institute of
Science & Technology (PRIST)
Deemed to be University
Thanjavur - 613 403.



PONNAIYAH RAMAJAYAM INSTITUTE OF
SCIENCE & TECHNOLOGY (PRIST)

Declared as DEEMED-TO-BE-UNIVERSITY
U/s 3 of UGC Act, 1956



CERTIFICATE

THIS IS PRESENTED TO

V.KAVIYARASAN (2101CA10143)

for completing the Certificate / Diploma course on “Android

App Development” From 17/07/2023 To 13/09/2023 In Department of

Computer Science , PRIST University, Thanjavur

K. Pinnalathar
Coordinator

HOD
Department of Computer Science
School of Arts & Science
Ponnaiyah Ramajayam
Institute of Science and Technology
(PRIST)
Thanjavur

Dean

DEAN
School of Arts & Science
Ponnaiyah Ramajayam Institute of
Science & Technology (PRIST)
Deemed to be University
Vallam, Thanjavur - 613 403.



PONNAIYAH RAMAJAYAM INSTITUTE OF
SCIENCE & TECHNOLOGY (PRIST)

Declared as DEEMED-TO-BE-UNIVERSITY
U/s 3 of UGC Act, 1956



CERTIFICATE

THIS IS PRESENTED TO

P.GOKUL (2101CA10144)

for completing the Certificate / Diploma course on “Android

App Development” From 17/07/2023 To 13/09/2023 In Department of

Computer Science , PRIST University, Thanjavur

K. Prasadharan

Coordinator

HOD
Department of Computer Science
School of Arts and Science
Ponnaiyah Ramajayam Institute of
Science and Technology (PRIST)
Thanjavur - 613 403.

[Signature]

DEAN

Dean

School of Arts & Science
Ponnaiyah Ramajayam Institute
Science & Technology (PRIST)
Deemed to be University
Vallam, Thanjavur - 613 403.



PONNAIYAH RAMAJAYAM INSTITUTE OF
SCIENCE & TECHNOLOGY (PRIST)

Declared as DEEMED-TO-BE-UNIVERSITY
U/s 3 of UGC Act, 1956



CERTIFICATE

THIS IS PRESENTED TO

R.PRAGADEESH (2101CA10145)

for completing the Certificate / Diploma course on “Android

App Development” From 17/07/2023 To 13/09/2023 In Department of

Computer Science , PRIST University, Thanjavur

K. P. Prasad

Coordinator

HOD
Department of Computer Science
School of Arts and Science
Ponnaiyah Ramajayam Institute of
Science and Technology (PRIST)
Thanjavur - 613 403.

[Handwritten Signature]

Dean

School of Arts & Science
Ponnaiyah Ramajayam Institute of
Science & Technology (PRIST)
Deemed to be University
Valmiki, Thanjavur - 613 403.

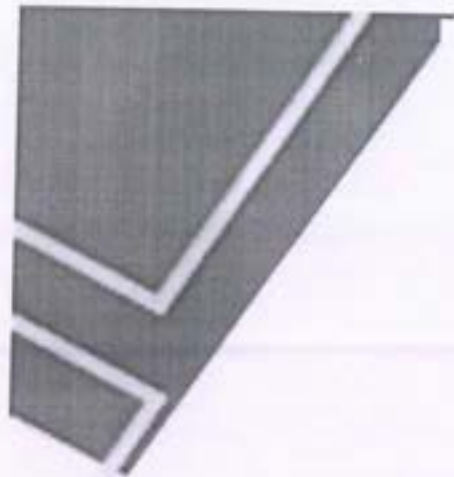

PONNAIYAH RAMAJAYAM INSTITUTE OF
SCIENCE & TECHNOLOGY (PRIST)

Declared as DEEMED-TO-BE-UNIVERSITY
U/s 3 of UGC Act, 1956



CERTIFICATE

THIS IS PRESENTED TO

S.GOWRIDHANYAYAN (2101CA10146)

for completing the Certificate / Diploma course on “Android

App Development” From 17/07/2023 To 13/09/2023 In Department of

Computer Science , PRIST University, Thanjavur

K. Ponnaiyer

Coordinator

HOD
Department of Computer Science
School of Arts and Science
Ponnaiyah Ramajayam Institute of
Science and Technology (PRIST)
Thanjavur - 613 403.

Dean

DEAN
School of Arts & Science
Ponnaiyah Ramajayam Institute
Science & Technology (PRIST)
Deemed to be University
Thanjavur - 613 403



PONNAIYAH RAMAJAYAM INSTITUTE OF
SCIENCE & TECHNOLOGY (PRIST)

Declared as DEEMED-TO-BE-UNIVERSITY
U/s 3 of UGC Act, 1956



CERTIFICATE

THIS IS PRESENTED TO

E.SIKAN (2101CA10147)

for completing the Certificate / Diploma course on “Android

App Development” From 17/07/2023 To 13/09/2023 In Department of

Computer Science , PRIST University, Thanjavur

K. Pinnalathini

Coordinator

HOD
Department of Computer Science
School of Arts and Science
Ponnaiyah Ramajayam Institute of
Science and Technology (PRIST)
Thanjavur - 613 403.

Dean

DEAN
School of Arts & Science
Ponnaiyah Ramajayam Institute of
Science & Technology (PRIST)
Deemed to be University
Vallam, Thanjavur - 613 403.



PONNAIYAH RAMAJAYAM INSTITUTE OF
SCIENCE & TECHNOLOGY (PRIST)

Declared as DEEMED-TO-BE-UNIVERSITY
U/s 3 of UGC Act, 1956



CERTIFICATE

THIS IS PRESENTED TO

M.ARIHARAN (2101CA10148)

for completing the Certificate / Diploma course on “Android

App Development” From 17/07/2023 To 13/09/2023 In Department of

Computer Science , PRIST University, Thanjavur

K. Pinnalathu

Coordinator

HOD
Department of Computer Science
School of Arts and Science
Ponnaiyah Ramajayam Institute of
Science and Technology (PRIST)
Thanjavur - 613 403.

[Signature]

Dean

DEAN
School of Arts & Science
Ponnaiyah Ramajayam Institute of
Science & Technology (PRIST)
Deemed to be University
Thanjavur - 613 403.



PONNAIYAH RAMAJAYAM INSTITUTE OF
SCIENCE & TECHNOLOGY (PRIST)

Declared as DEEMED-TO-BE-UNIVERSITY
U/s 3 of UGC Act, 1956



CERTIFICATE

THIS IS PRESENTED TO

M.EHIYA RAIHAN (2101CA10149)

for completing the Certificate / Diploma course on “Android

App Development” From 17/07/2023 To 13/09/2023 In Department of

Computer Science , PRIST University, Thanjavur

K. Prasad

Coordinator

HOD
Department of Computer Science
School of Arts and Science
Ponnaiyah Ramajayam Institute of
Science and Technology (PRIST)
Thanjavur - 613 403.

[Signature]

Dean

DEAN
School of Arts & Science
Ponnaiyah Ramajayam Institute of
Science & Technology (PRIST)
Deemed to be University
Vallam, Thanjavur - 613 403.



PONNAIYAH RAMAJAYAM INSTITUTE OF
SCIENCE & TECHNOLOGY (PRIST)

Declared as DEEMED-TO-BE-UNIVERSITY
U/s 3 of UGC Act, 1956



CERTIFICATE

THIS IS PRESENTED TO

P.KRISHNAN (2101CA10150)

for completing the Certificate / Diploma course on “Android

App Development” From 17/07/2023 To 13/09/2023 In Department of

Computer Science , PRIST University, Thanjavur

K. Pinnellu

Coordinator

HOD
Department of Computer Science
School of Arts and Science
Ponnaiyah Ramajayam Institute of
Science and Technology (PRIST)
Thanjavur - 613 403

Dean

DEAN
School of Arts & Science
Ponnaiyah Ramajayam Institute of
Science & Technology (PRIST)
Deemed to be University
Vallam, Thanjavur - 613 403.



PONNAIYAH RAMAJAYAM INSTITUTE OF
SCIENCE & TECHNOLOGY (PRIST)

Declared as DEEMED-TO-BE-UNIVERSITY
U/s 3 of UGC Act, 1956



CERTIFICATE

THIS IS PRESENTED TO

P.SURESH KUMAR (2101CA10151)

for completing the Certificate / Diploma course on “Android

App Development” From 17/07/2023 To 13/09/2023 In Department of

Computer Science , PRIST University, Thanjavur

K. Pinnalathu

Coordinator

HOD

Department of Computer Science
School of Arts and Science
Ponnaiyah Ramajayam Institute of
Science and Technology (PRIST)
Thanjavur - 613 403.

DEAN

Dean

School of Arts & Science
Ponnaiyah Ramajayam Institute of
Science & Technology (PRIST)
Deemed to be University
Vallem, Thanjavur - 613 403.

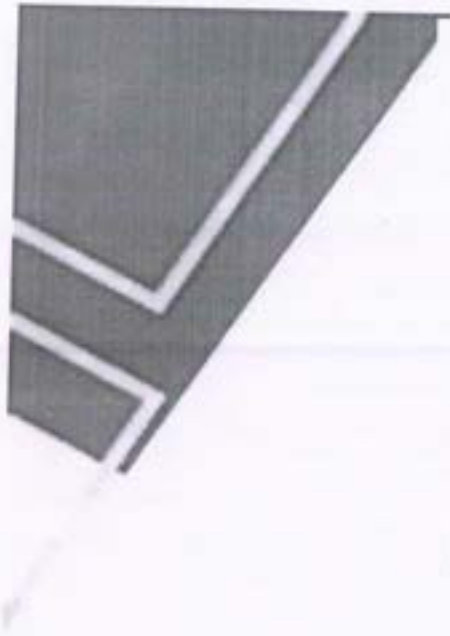

**PONNAIYAH RAMAJAYAM INSTITUTE OF
SCIENCE & TECHNOLOGY (PRIST)**

Declared as DEEMED-TO-BE-UNIVERSITY
U/s 3 of UGC Act, 1956



CERTIFICATE

THIS IS PRESENTED TO

VEERAMANI K (2201CS10101)

for completing the Certificate / Diploma course on “Android

App Development” From 17/07/2023 To 13/09/2023 In Department of

Computer Science , PRIST University, Thanjavur

K. Prasadharan
Coordinator

[Signature]
Dean

HOD
Department of Computer Science
School of Arts and Science
Ponnaiyah Ramajayam Institute of
Science and Technology (PRIST)
Thanjavur - 613 403.

DEAN
School of Arts & Science
Ponnaiyah Ramajayam Institute of
Science & Technology (PRIST)
Deemed to be University
Vallem, Thanjavur - 613 403.



PONNAIYAH RAMAJAYAM INSTITUTE OF
SCIENCE & TECHNOLOGY (PRIST)

Declared as DEEMED-TO-BE-UNIVERSITY
U/s 3 of UGC Act, 1956



CERTIFICATE

THIS IS PRESENTED TO

ABINASH V (2201CS10102)

for completing the Certificate / Diploma course on “Android

App Development” From 17/07/2023 To 13/09/2023 In Department of

Computer Science , PRIST University, Thanjavur

K. Prasad

Coordinator

HOD
Department of Computer Science
School of Science
Ponnaiyah Ramajayam Institute of
Science & Technology (PRIST)
Thanjavur - 613 403.

DEAN

Dean

School of Arts & Science
Ponnaiyah Ramajayam Institute of
Science & Technology (PRIST)
Deemed to be University
Thanjavur - 613 403.



PONNAIYAH RAMAJAYAM INSTITUTE OF
SCIENCE & TECHNOLOGY (PRIST)

Declared as DEEMED-TO-BE-UNIVERSITY
U/s 3 of UGC Act, 1956



CERTIFICATE

THIS IS PRESENTED TO

RAGHU R (2201CS10103)

for completing the Certificate / Diploma course on “Android

App Development” From 17/07/2023 To 13/09/2023 In Department of

Computer Science , PRIST University, Thanjavur

K. P. Prasad

Coordinator

HOD
Department of Computer Science
School of Arts and Science
Ponnaiyah Ramajayam Institute of
Science and Technology (PRIST)
Thanjavur - 613 403.

DEAN

Dean

School of Arts & Science
Ponnaiyah Ramajayam Institute of
Science & Technology (PRIST)
Deemed to be University
Vallem, Thanjavur - 613 403.



PONNAIYAH RAMAJAYAM INSTITUTE OF
SCIENCE & TECHNOLOGY (PRIST)

Declared as DEEMED-TO-BE-UNIVERSITY
U/s 3 of UGC Act, 1956



CERTIFICATE

THIS IS PRESENTED TO

MANISHKANTH P S (2201CS10104)

*for completing the Certificate / Diploma course on “Android
App Development” From 17/07/2023 To 13/09/2023 In Department of
Computer Science , PRIST University, Thanjavur*

K. P. Prasad

Coordinator

HOD

Department of Computer Science
School of Arts and Science
Ponnaiyah Ramajayam Institute of
Science and Technology (PRIST)
Thanjavur - 613 403.

DEAN

Dean

School of Arts & Science
Ponnaiyah Ramajayam Institute of
Science & Technology (PRIST)
Deemed to be University
Thanjavur - 613 403



PONNAIYAH RAMAJAYAM INSTITUTE OF
SCIENCE & TECHNOLOGY (PRIST)

Declared as DEEMED-TO-BE-UNIVERSITY
U/s 3 of UGC Act, 1956



CERTIFICATE

THIS IS PRESENTED TO

SANJAI I (2201CS10105)

for completing the Certificate / Diploma course on “Android

App Development” From 17/07/2023 To 13/09/2023 In Department of

Computer Science , PRIST University, Thanjavur

K. P. Prasad

Coordinator

HOD

Department of Computer Science
School of Arts and Science
Ponnaiyah Ramajayam Institute of
Science and Technology (PRIST)
Thanjavur - 613 403.

[Signature]

DEAN

Dean

School of Arts & Science
Ponnaiyah Ramajayam Institute of
Science & Technology (PRIST)
Deemed to be University
Valiam, Thanjavur - 613 403.



PONNAIYAH RAMAJAYAM INSTITUTE OF
SCIENCE & TECHNOLOGY (PRIST)

Declared as DEEMED-TO-BE-UNIVERSITY
U/s 3 of UGC Act, 1956



CERTIFICATE

THIS IS PRESENTED TO

MANIKANDAN K (2201CS10106)

for completing the Certificate / Diploma course on “Android

App Development” From 17/07/2023 To 13/09/2023 In Department of

Computer Science , PRIST University, Thanjavur

K. Pinnalatha
Coordinator

Dean
Dean

HOD
Department of Computer Science
School of Computer Science
Ponnaiyah Ramajayam Institute of
Science and Technology (PRIST)
Thanjavur - 613 403.

DEAN
School of Arts & Science
Ponnaiyah Ramajayam Institute of
Science & Technology (PRIST)
Deemed to be University
Thanjavur - 613 403.



PONNAIYAH RAMAJAYAM INSTITUTE OF
SCIENCE & TECHNOLOGY (PRIST)

Declared as DEEMED-TO-BE-UNIVERSITY
U/s 3 of UGC Act, 1956



CERTIFICATE

THIS IS PRESENTED TO

JAGADESHWARAN P (2201CS10107)

for completing the Certificate / Diploma course on “Android

App Development” From 17/07/2023 To 13/09/2023 In Department of

Computer Science , PRIST University, Thanjavur

K. Prasad
Coordinator

HOD
Department of Computer Science
School of Arts and Science
Ponnaiyah Ramajayam Institute of
Science & Technology (PRIST)
Deemed to be University
Vellam, Thanjavur - 613 403.

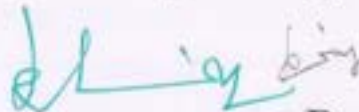
Dean

DEAN
School of Arts & Science
Ponnaiyah Ramajayam Institute of
Science & Technology (PRIST)
Deemed to be University
Vellam, Thanjavur - 613 403.



PONNAIYAH RAMAJAYAM INSTITUTE OF
SCIENCE & TECHNOLOGY (PRIST)

Declared as DEEMED-TO-BE-UNIVERSITY
U/s 3 of UGC Act, 1956



CERTIFICATE

THIS IS PRESENTED TO

PRAVEEN B (2201CS10108)

for completing the Certificate / Diploma course on “Android

App Development” From 17/07/2023 To 13/09/2023 In Department of

Computer Science , PRIST University, Thanjavur

K. Prasad
Coordinator

HOD
Department of Computer Science
School of Arts and Science
Ponnaiyah Ramajayam Institute of
Science and Technology (PRIST)
Thanjavur - 613 403.

Dean

DEAN
School of Arts & Science
Ponnaiyah Ramajayam Institute of
Science & Technology (PRIST)
Deemed to be University
Thanjavur - 613 403.



PONNAIYAH RAMAJAYAM INSTITUTE OF
SCIENCE & TECHNOLOGY (PRIST)

Declared as DEEMED-TO-BE-UNIVERSITY
U/s 3 of UGC Act, 1956



CERTIFICATE

THIS IS PRESENTED TO

MOHAMED THOUFIK M (2201CS10110)

*for completing the Certificate / Diploma course on “Android
App Development” From 17/07/2023 To 13/09/2023 In Department of
Computer Science , PRIST University, Thanjavur*

K. Prasad Kumar
Coordinator

HOD
Department of Computer Science
School of Arts & Science
Ponnaiyah Ramajayam Institute of
Science & Technology (PRIST)
Thanjavur - 613 403.

Dean

DEAN
School of Arts & Science
Ponnaiyah Ramajayam Institute of
Science & Technology (PRIST)
Deemed to be University
Thanjavur - 613 403



PONNAIYAH RAMAJAYAM INSTITUTE OF
SCIENCE & TECHNOLOGY (PRIST)

Declared as DEEMED-TO-BE-UNIVERSITY
U/s 3 of UGC Act, 1956



CERTIFICATE

THIS IS PRESENTED TO

KESHAVARAM M S (2201CS10111)

for completing the Certificate / Diploma course on “Android

App Development” From 17/07/2023 To 13/09/2023 In Department of

Computer Science , PRIST University, Thanjavur

K. Prasad

Coordinator

HOD
Department of Computer Science
School of Arts & Science
Ponnaiyah Ramajayam Institute of
Science and Technology (PRIST)
Thanjavur

Dean

DEAN
School of Arts & Science
Ponnaiyah Ramajayam Institute of
Science & Technology (PRIST)
Deemed to be University
Thanjavur - 613 403.



PONNAIYAH RAMAJAYAM INSTITUTE OF
SCIENCE & TECHNOLOGY (PRIST)

Declared as DEEMED-TO-BE-UNIVERSITY
U/s 3 of UGC Act, 1956



CERTIFICATE

THIS IS PRESENTED TO

SANTHOSH S (2201CS10112)

for completing the Certificate / Diploma course on “Android

App Development” From 17/07/2023 To 13/09/2023 In Department of

Computer Science , PRIST University, Thanjavur

K. P. Prasad

Coordinator

HOD

Department of Computer Science
School of Arts and Science
Ponnaiyah Ramajayam Institute of
Science and Technology (PRIST)
Thanjavur - 613 403.

Dean

DEAN

School of Arts & Science
Ponnaiyah Ramajayam Institute of
Science & Technology (PRIST)
Deemed to be University
Thanjavur - 613 403.



PONNAIYAH RAMAJAYAM INSTITUTE OF
SCIENCE & TECHNOLOGY (PRIST)

Declared as DEEMED-TO-BE-UNIVERSITY
U/s 3 of UGC Act, 1956



CERTIFICATE

THIS IS PRESENTED TO

ABISHEK E (2201CS10113)

for completing the Certificate / Diploma course on “Android

App Development” From 17/07/2023 To 13/09/2023 In Department of

Computer Science , PRIST University, Thanjavur

K. Pinnalathu

Coordinator

HOD

Department of Computer Science
School of Arts and Science
Ponnaiyah Ramajayam Institute of
Science and Technology (PRIST)
Thanjavur - 613 403.

Dean

DEAN

School of Arts & Science
Ponnaiyah Ramajayam Institute of
Science & Technology (PRIST)
Deemed to be University
Thanjavur - 613 403.

PNNAIYAH RAMAJAYAM INSTITUTE OF
SCIENCE & TECHNOLOGY (PRIST)

Declared as DEEMED-TO-BE-UNIVERSITY
U/s 3 of UGC Act, 1956



CERTIFICATE

THIS IS PRESENTED TO

K.BHUVANESHKUMAR (2101CS10135)

for completing the Certificate / Diploma course on "Designing

[Photoshop, Premium, Illustrator]" From 17/07/2023 To 13/09/2023

In Department of Computer Science , PRIST University, Thanjavur

Coordinator

K. P. M.

HOD

[Signature]

Department of Computer Science
School of Arts and Science
Ponnaiyah Ramajayam Institute of
Science and Technology (PRIST)
Thanjavur - 613 403.

Dean

[Signature]

DEAN
School of Arts & Science
Ponnaiyah Ramajayam Institute of
Science & Technology (PRIST)
Deemed to be University
Thanjavur, Thanjavur - 613 403.



PONNAIYAH RAMAJAYAM INSTITUTE OF
SCIENCE & TECHNOLOGY (PRIST)

Declared as DEEMED-TO-BE-UNIVERSITY
U/s 3 of UGC Act, 1956

CERTIFICATE

THIS IS PRESENTED TO

R.VIJAY (2101CS10136)

for completing the Certificate / Diploma course on “Designing

[Photoshop, Premium, Illustrator]” From 17/07/2023 To 13/09/2023

In Department of Computer Science , PRIST University, Thanjavur

K. Prasadharan
Coordinator

HOD

Department of Computer Science
School of Arts and Science
Ponnaiyah Ramajayam Institute of
Science and Technology (PRIST)
Thanjavur - 613 403.

Dean

DEAN

School of Arts & Science
Ponnaiyah Ramajayam Institute of
Science & Technology (PRIST)
Deemed to be University
Thanjavur - 613 403.





PONNAIYAH RAMAJAYAM INSTITUTE OF
SCIENCE & TECHNOLOGY (PRIST)

Declared as DEEMED-TO-BE-UNIVERSITY
U/s 3 of UGC Act, 1956

CERTIFICATE

THIS IS PRESENTED TO

S.KEERTHIVASAN (2101CS10137)

for completing the Certificate / Diploma course on “Designing

[Photoshop, Premium, Illustrator]” From 17/07/2023 To 13/09/2023

In Department of Computer Science , PRIST University, Thanjavur

K. P. *P. Prasad*
Coordinator

Department of Computer Science
School of Arts and Science
Ponnaiyah Ramajayam Institute of
Science and Technology (PRIST)
Thanjavur - 613 403.

Dean

DEAN
School of Arts & Science
Ponnaiyah Ramajayam Institute of
Science & Technology (PRIST)
Deemed to be University
Vellam, Thanjavur - 613 403.



PONNAIYAH RAMAJAYAM INSTITUTE OF
SCIENCE & TECHNOLOGY (PRIST)

Declared as DEEMED-TO-BE-UNIVERSITY
U/s 3 of UGC Act, 1956



CERTIFICATE

THIS IS PRESENTED TO

FELIX BHARATH R (2101CS10138)

for completing the Certificate / Diploma course on "Designing

[Photoshop, Premium, Illustrator]" From 17/07/2023 To 13/09/2023

In Department of Computer Science , PRIST University, Thanjavur

Coordinator

K. P. M. S.

HOD

[Signature]

Department of Computer Science
School of Arts and Science
Ponnaiyah Ramajayam Institute of
Science and Technology (PRIST)
Thanjavur - 613 403.

DEAN

Dean

[Signature]

School of Arts & Science
Ponnaiyah Ramajayam Institute of
Science & Technology (PRIST)
Deemed to be University
Valur, Thanjavur - 613 403.



PONNAIYAH RAMAJAYAM INSTITUTE OF
SCIENCE & TECHNOLOGY (PRIST)

Declared as DEEMED-TO-BE-UNIVERSITY
U/s 3 of UGC Act, 1956

CERTIFICATE

THIS IS PRESENTED TO

A.KAMESHWARAN (2101CS10139)

for completing the Certificate / Diploma course on “Designing

[Photoshop, Premium, Illustrator]” From 17/07/2023 To 13/09/2023

In Department of Computer Science , PRIST University, Thanjavur

K. Pinnalath
Coordinator

HOD

Department of Computer Science
School of Arts and Science
Ponnaiyah Ramajayam Institute of
Science & Technology (PRIST)
Vellam, Thanjavur - 613 403.

Dean

DEAN
School of Arts & Science
Ponnaiyah Ramajayam Institute of
Science & Technology (PRIST)
Deemed to be University
Vellam, Thanjavur - 613 403.





PONNAIYAH RAMAJAYAM INSTITUTE OF
SCIENCE & TECHNOLOGY (PRIST)

Declared as DEEMED-TO-BE-UNIVERSITY
U/s 3 of UGC Act, 1956

CERTIFICATE

THIS IS PRESENTED TO

K.YOGESH (2101CS10140)

for completing the Certificate / Diploma course on “Designing

[Photoshop, Premium, Illustrator]” From 17/07/2023 To 13/09/2023

In Department of Computer Science , PRIST University, Thanjavur

K. Prasadharan
Coordinator

HOD

Department of Computer Science
School of Arts and Science
Ponnaiyah Ramajayam Institute of
Science and Technology (PRIST)
Thanjavur - 613 403.

Dean

DEAN

School of Arts & Science
Ponnaiyah Ramajayam Institute of
Science & Technology (PRIST)
Deemed to be University
Valiam, Thanjavur - 613 403.





PONNAIYAH RAMAJAYAM INSTITUTE OF
SCIENCE & TECHNOLOGY (PRIST)

Declared as DEEMED-TO-BE-UNIVERSITY
U/s 3 of UGC Act, 1956

CERTIFICATE

THIS IS PRESENTED TO

SANGEETHA D (2101CS10208)

for completing the Certificate / Diploma course on “Designing

[Photoshop, Premium, Illustrator]” From 17/07/2023 To 13/09/2023

In Department of Computer Science , PRIST University, Thanjavur

K. Pinaraj
Coordinator

HOD

Department of Computer Science
School of Arts and Science
Ponnaiyah Ramajayam Institute of
Science and Technology (PRIST)
Thanjavur - 613 403.

Dean

DEAN
School of Arts & Science
Ponnaiyah Ramajayam Institute of
Science & Technology (PRIST)
Deemed to be University
Valiam, Thanjavur - 613 403.





PONNAIYAH RAMAJAYAM INSTITUTE OF
SCIENCE & TECHNOLOGY (PRIST)

Declared as DEEMED-TO-BE-UNIVERSITY
U/s 3 of UGC Act, 1956

CERTIFICATE

THIS IS PRESENTED TO

SARANYA L (2101CS10209)

for completing the Certificate / Diploma course on “Designing

[Photoshop, Premium, Illustrator]” From 17/07/2023 To 13/09/2023

In Department of Computer Science , PRIST University, Thanjavur

K. P. Prasad
Coordinator

HOD

Department of Computer Science
School of Arts and Science
Ponnaiyah Ramajayam Institute of
Science and Technology (PRIST)
Thanjavur - 613 403.

Dean

DEAN

School of Arts & Science
Ponnaiyah Ramajayam Institute of
Science & Technology (PRIST)
Deemed to be University
Valiam, Thanjavur - 613 403.





PONNAIYAH RAMAJAYAM INSTITUTE OF
SCIENCE & TECHNOLOGY (PRIST)

Declared as DEEMED-TO-BE-UNIVERSITY
U/s 3 of UGC Act, 1956

CERTIFICATE

THIS IS PRESENTED TO

SIVAPRIYA P (2101CS10210)

for completing the Certificate / Diploma course on “Designing

[Photoshop, Premium, Illustrator]” From 17/07/2023 To 13/09/2023

In Department of Computer Science , PRIST University, Thanjavur

K. P. S. S. S.
Coordinator

HOD

Department of Computer Science
School of Arts and Science
Ponnaiyah Ramajayam Institute of
Science and Technology (PRIST)
Thanjavur - 613 403.

Dean

DEAN
School of Arts & Science
Ponnaiyah Ramajayam Institute of
Science & Technology (PRIST)
Deemed to be University
Vellam, Thanjavur - 613 403.





PONNAIYAH RAMAJAYAM INSTITUTE OF
SCIENCE & TECHNOLOGY (PRIST)

Declared as DEEMED-TO-BE-UNIVERSITY
U/s 3 of UGC Act, 1956

CERTIFICATE

THIS IS PRESENTED TO

SUSISTRA S (2101CS10211)

for completing the Certificate / Diploma course on “Designing

[Photoshop, Premium, Illustrator]” From 17/07/2023 To 13/09/2023

In Department of Computer Science , PRIST University, Thanjavur

K. P. Prasad
Coordinator

HOD

Department of Computer Science
School of Arts and Science
Ponnaiyah Ramajayam Institute of
Science and Technology (PRIST)
Thanjavur - 813 403.

Dean

DEAN
School of Arts & Science
Ponnaiyah Ramajayam Institute of
Science & Technology (PRIST)
Deemed to be University
Valiam, Thanjavur - 813 403.





PONNAIYAH RAMAJAYAM INSTITUTE OF
SCIENCE & TECHNOLOGY (PRIST)

Declared as DEEMED-TO-BE-UNIVERSITY
U/s 3 of UGC Act, 1956

CERTIFICATE

THIS IS PRESENTED TO

KAVIMANI M (2010CA10101)

for completing the Certificate / Diploma course on “Designing

[Photoshop, Premium, Illustrator]” From 17/07/2023 To 13/09/2023

In Department of Computer Science , PRIST University, Thanjavur

K. Pinaraj
Coordinator

HOD

Department of Computer Science
School of Arts and Science
Ponnaiyah Ramajayam Institute of
Science and Technology (PRIST)
Thanjavur - 813 403.

Dean

DEAN
School of Arts & Science
Ponnaiyah Ramajayam Institute of
Science & Technology (PRIST)
Deemed to be University
Vallem, Thanjavur - 813 403.





PONNAIYAH RAMAJAYAM INSTITUTE OF
SCIENCE & TECHNOLOGY (PRIST)

Declared as DEEMED-TO-BE-UNIVERSITY
U/s 3 of UGC Act, 1956



CERTIFICATE

THIS IS PRESENTED TO

R.PRAKASH (2101CA10102)

for completing the Certificate / Diploma course on “Designing

[Photoshop, Premium, Illustrator]” From 17/07/2023 To 13/09/2023

In Department of Computer Science , PRIST University, Thanjavur

K. P. Prasad
Coordinator

HOD

Department of Computer Science
School of Arts and Science
Ponnaiyah Ramajayam Institute of
Science and Technology (PRIST)
Thanjavur - 613 403.

Dean

DEAN

School of Arts & Science
Ponnaiyah Ramajayam Institute of
Science & Technology (PRIST)
Deemed to be University
Vallem, Thanjavur - 613 403.



PONNAIYAH RAMAJAYAM INSTITUTE OF
SCIENCE & TECHNOLOGY (PRIST)

Declared as DEEMED-TO-BE-UNIVERSITY
U/s 3 of UGC Act, 1956

CERTIFICATE

THIS IS PRESENTED TO

D.AKASH (2101CA10104)

for completing the Certificate / Diploma course on “Designing

[Photoshop, Premium, Illustrator]” From 17/07/2023 To 13/09/2023

In Department of Computer Science , PRIST University, Thanjavur

K. Pinnalatha
Coordinator

HOD
Department of Computer Science
School of Arts and Science
Ponnaiyah Ramajayam Institute of
Science and Technology (PRIST)
Thanjavur - 613 403.

Dean

DEAN
School of Arts & Science
Ponnaiyah Ramajayam Institute of
Science & Technology (PRIST)
Deemed to be University
Valiam, Thanjavur - 613 403.





PONNAIYAH RAMAJAYAM INSTITUTE OF
SCIENCE & TECHNOLOGY (PRIST)

Declared as DEEMED-TO-BE-UNIVERSITY
U/s 3 of UGC Act, 1956

CERTIFICATE

THIS IS PRESENTED TO

M.DHINESH BALAJI (2101CA10105)

for completing the Certificate / Diploma course on “Designing

[Photoshop, Premium, Illustrator]” From 17/07/2023 To 13/09/2023

In Department of Computer Science , PRIST University, Thanjavur

K. Prasadharan
Coordinator

HOD

Department of Computer Science
School of Arts and Science
Ponnaiyah Ramajayam Institute of
Science and Technology (PRIST)
Thanjavur - 613 403.

Dean

DEAN
School of Arts & Science
Ponnaiyah Ramajayam Institute of
Science & Technology (PRIST)
Deemed to be University
Vallem, Thanjavur - 613 403.





PONNAIYAH RAMAJAYAM INSTITUTE OF
SCIENCE & TECHNOLOGY (PRIST)

Declared as DEEMED-TO-BE-UNIVERSITY
U/s 3 of UGC Act, 1956

CERTIFICATE

THIS IS PRESENTED TO

A.ARSHAD JASIR (2101CA10106)

for completing the Certificate / Diploma course on “Designing

[Photoshop, Premium, Illustrator]” From 17/07/2023 To 13/09/2023

In Department of Computer Science , PRIST University, Thanjavur

K. Pinnalathin
Coordinator

HOD

Department of Computer Science
School of Arts and Science
Ponnaiyah Ramajayam Institute of
Science and Technology (PRIST)
Thanjavur - 613 403.

Dean

DEAN
School of Arts & Science
Ponnaiyah Ramajayam Institute of
Science & Technology (PRIST)
Deemed to be University
Valiam, Thanjavur - 613 403.





PONNAIYAH RAMAJAYAM INSTITUTE OF
SCIENCE & TECHNOLOGY (PRIST)

Declared as DEEMED-TO-BE-UNIVERSITY
U/s 3 of UGC Act, 1956

CERTIFICATE

THIS IS PRESENTED TO

M.HAREESH (2101CA10107)

for completing the Certificate / Diploma course on “Designing

[Photoshop, Premium, Illustrator]” From 17/07/2023 To 13/09/2023

In Department of Computer Science , PRIST University, Thanjavur

K. Prasadharan
Coordinator

HOD

Department of Computer Science
School of Arts and Science
Ponnaiyah Ramajayam Institute of
Science and Technology (PRIST)
Thanjavur - 613 403.

Dean

DEAN

School of Arts & Science
Ponnaiyah Ramajayam Institute of
Science & Technology (PRIST)
Deemed to be University
Valiam, Thanjavur - 613 403.





PONNAIYAH RAMAJAYAM INSTITUTE OF
SCIENCE & TECHNOLOGY (PRIST)

Declared as DEEMED-TO-BE-UNIVERSITY
U/s 3 of UGC Act, 1956

CERTIFICATE

THIS IS PRESENTED TO

M.VEERAKUMAR (2101CA10108)

for completing the Certificate / Diploma course on “Designing

[Photoshop, Premium, Illustrator]” From 17/07/2023 To 13/09/2023

In Department of Computer Science , PRIST University, Thanjavur

K. P. Prasad
Coordinator

HOD

Department of Computer Science
School of Arts and Science
Ponnaiyah Ramajayam Institute of
Science and Technology (PRIST)
Thanjavur - 613 403.

Dean

DEAN
School of Arts & Science
Ponnaiyah Ramajayam Institute of
Science & Technology (PRIST)
Deemed to be University
Valiam, Thanjavur - 613 403.





PONNAIYAH RAMAJAYAM INSTITUTE OF
SCIENCE & TECHNOLOGY (PRIST)

Declared as DEEMED-TO-BE-UNIVERSITY
U/s 3 of UGC Act, 1956

CERTIFICATE

THIS IS PRESENTED TO

A.NAVEEBRAJ (2101CA10110)

for completing the Certificate / Diploma course on “Designing

[Photoshop, Premium, Illustrator]” From 17/07/2023 To 13/09/2023

In Department of Computer Science , PRIST University, Thanjavur

K. Pinnalatha
Coordinator

HOD

Department of Computer Science
School of Arts and Science
Ponnaiyah Ramajayam Institute of
Science and Technology (PRIST)
Thanjavur - 613 403.

Dean

DEAN

School of Arts & Science
Ponnaiyah Ramajayam Institute of
Science & Technology (PRIST)
Deemed to be University
Valiam, Thanjavur - 613 403.





PONNAIYAH RAMAJAYAM INSTITUTE OF
SCIENCE & TECHNOLOGY (PRIST)

Declared as DEEMED-TO-BE-UNIVERSITY
U/s 3 of UGC Act, 1956

CERTIFICATE

THIS IS PRESENTED TO

B.MITHUNRAJ (2101CA10111)

for completing the Certificate / Diploma course on “Designing

[Photoshop, Premium, Illustrator]” From 17/07/2023 To 13/09/2023

In Department of Computer Science , PRIST University, Thanjavur

K. Pinnalathin
Coordinator

HOD

Department of Computer Science
School of Arts and Science
Ponnaiyah Ramajayam Institute of
Science and Technology (PRIST)
Thanjavur - 613 403.

Dean

DEAN
School of Arts & Science
Ponnaiyah Ramajayam Institute of
Science & Technology (PRIST)
Deemed to be University
Valiam, Thanjavur - 613 403.





PONNAIYAH RAMAJAYAM INSTITUTE OF
SCIENCE & TECHNOLOGY (PRIST)

Declared as DEEMED-TO-BE-UNIVERSITY
U/s 3 of UGC Act, 1956

CERTIFICATE

THIS IS PRESENTED TO

M.FAYAS AHAMED (2101CA10112)

for completing the Certificate / Diploma course on “Designing

[Photoshop, Premium, Illustrator]” From 17/07/2023 To 13/09/2023

In Department of Computer Science , PRIST University, Thanjavur

K. Pinnalatha
Coordinator

HUD

Department of Computer Science
School of Arts and Science
Ponnaiyah Ramajayam Institute of
Science and Technology (PRIST)
Thanjavur - 613 403.

Dean

DEAN
School of Arts & Science
Ponnaiyah Ramajayam Institute of
Science & Technology (PRIST)
Deemed to be University
Vellam, Thanjavur - 613 403.





PONNAIYAH RAMAJAYAM INSTITUTE OF
SCIENCE & TECHNOLOGY (PRIST)

Declared as DEEMED-TO-BE-UNIVERSITY
U/s 3 of UGC Act, 1956

CERTIFICATE

THIS IS PRESENTED TO

MADHAN KUMAR G (2101CA10113)

for completing the Certificate / Diploma course on “Designing

[Photoshop, Premium, Illustrator]” From 17/07/2023 To 13/09/2023

In Department of Computer Science , PRIST University, Thanjavur

K. Pinnalathin
Coordinator

HOD

Department of Computer Science
School of Arts and Science
Ponnaiyah Ramajayam Institute of
Science and Technology (PRIST)
Thanjavur - 613 403.

Dean

DEAN

School of Arts & Science
Ponnaiyah Ramajayam Institute of
Science & Technology (PRIST)
Deemed to be University
Vellam, Thanjavur - 613 403.





PONNAIYAH RAMAJAYAM INSTITUTE OF
SCIENCE & TECHNOLOGY (PRIST)

Declared as DEEMED-TO-BE-UNIVERSITY
U/s 3 of UGC Act, 1956

CERTIFICATE

THIS IS PRESENTED TO

E.TAMIZHARASAN (2101CA10114)

for completing the Certificate / Diploma course on “Designing

[Photoshop, Premium, Illustrator]” From 17/07/2023 To 13/09/2023

In Department of Computer Science , PRIST University, Thanjavur

K. P. Prasad
Coordinator

HOD

Department of Computer Science
School of Arts and Science
Ponnaiyah Ramajayam Institute of
Science and Technology (PRIST)
Thanjavur - 613 403

Dean

DEAN
School of Arts & Science
Ponnaiyah Ramajayam Institute of
Science & Technology (PRIST)
Deemed to be University
Vallam, Thanjavur - 613 403.





PONNAIYAH RAMAJAYAM INSTITUTE OF
SCIENCE & TECHNOLOGY (PRIST)

Declared as DEEMED-TO-BE-UNIVERSITY
U/s 3 of UGC Act, 1956



CERTIFICATE

THIS IS PRESENTED TO

MOHAMED HABZAR H (2101CA10115)

for completing the Certificate / Diploma course on “Designing

[Photoshop, Premium, Illustrator]” From 17/07/2023 To 13/09/2023

In Department of Computer Science , PRIST University, Thanjavur

K. P. Prasad
Coordinator

HOD

Department of Computer Science
School of Arts and Science
Ponnaiyah Ramajayam Institute of
Science and Technology (PRIST)
Thanjavur - 613 403.

Dean

DEAN
School of Arts & Science
Ponnaiyah Ramajayam Institute of
Science & Technology (PRIST)
Deemed to be University
Valiam, Thanjavur - 613 403.



PONNAIYAH RAMAJAYAM INSTITUTE OF
SCIENCE & TECHNOLOGY (PRIST)

Declared as DEEMED-TO-BE-UNIVERSITY
U/s 3 of UGC Act, 1956

CERTIFICATE

THIS IS PRESENTED TO

K.MOHAMED FAYAS (2101CA10116)

for completing the Certificate / Diploma course on “Designing

[Photoshop, Premium, Illustrator]” From 17/07/2023 To 13/09/2023

In Department of Computer Science , PRIST University, Thanjavur

K. Pinnalathin
Coordinator

HOD

Department of Computer Science
School of Arts and Science
Ponnaiyah Ramajayam Institute of
Science and Technology (PRIST)
Thanjavur - 613 403.

Dean

DEAN

School of Arts & Science
Ponnaiyah Ramajayam Institute of
Science & Technology (PRIST)
Deemed to be University
Vallam, Thanjavur - 613 403.



PONNAIYAH RAMAJAYAM INSTITUTE OF
SCIENCE & TECHNOLOGY (PRIST)

Declared as DEEMED-TO-BE-UNIVERSITY
U/s 3 of UGC Act, 1956



CERTIFICATE

THIS IS PRESENTED TO

MOHAMED SIRAJUDEN S (2101CA10117)

for completing the Certificate / Diploma course on "Designing

[Photoshop, Premium, Illustrator]" From 17/07/2023 To 13/09/2023

In Department of Computer Science , PRIST University, Thanjavur

Coordinator

K. P. M. B.

Department of Computer Science
School of Arts and Science
Ponnaiyah Ramajayam Institute of
Science and Technology (PRIST)
Thanjavur - 613 403.

HOD

DEAN
School of Arts & Science
Ponnaiyah Ramajayam Institute of
Science & Technology (PRIST)
Deemed to be University
Vallam, Thanjavur - 613 403.

Dean





PONNAIYAH RAMAJAYAM INSTITUTE OF
SCIENCE & TECHNOLOGY (PRIST)

Declared as DEEMED-TO-BE-UNIVERSITY
U/s 3 of UGC Act, 1956

CERTIFICATE

THIS IS PRESENTED TO

J.MOHAMED BILAL J (2101CA10118)

for completing the Certificate / Diploma course on “Designing

[Photoshop, Premium, Illustrator]” From 17/07/2023 To 13/09/2023

In Department of Computer Science , PRIST University, Thanjavur

K. P. S. S. S.
Coordinator

[Signature]
HOD
Department of Computer Science
School of Arts and Science
Ponnaiyah Ramajayam Institute of
Science and Technology (PRIST)
Thanjavur - 613 403.

[Signature]
Dean
DEAN
School of Arts & Science
Ponnaiyah Ramajayam Institute of
Science & Technology (PRIST)
Deemed to be University
Vallam, Thanjavur - 613 403.





PONNAIYAH RAMAJAYAM INSTITUTE OF
SCIENCE & TECHNOLOGY (PRIST)

Declared as DEEMED-TO-BE-UNIVERSITY
U/s 3 of UGC Act, 1956

CERTIFICATE

THIS IS PRESENTED TO

SUNDARESWARAN M (2101CA10119)

for completing the Certificate / Diploma course on “Designing

[Photoshop, Premium, Illustrator]” From 17/07/2023 To 13/09/2023

In Department of Computer Science , PRIST University, Thanjavur

K. P. Prasad
Coordinator

HOD

Department of Computer Science
School of Arts and Science
Ponnaiyah Ramajayam Institute of
Science and Technology (PRIST)
Thanjavur - 613 403.

Dean

DEAN

School of Arts & Science
Ponnaiyah Ramajayam Institute of
Science & Technology (PRIST)
Deemed to be University
Valur m, Thanjavur - 613 403.





PONNAIYAH RAMAJAYAM INSTITUTE OF
SCIENCE & TECHNOLOGY (PRIST)

Declared as DEEMED-TO-BE-UNIVERSITY
U/s 3 of UGC Act, 1956

CERTIFICATE

THIS IS PRESENTED TO

L.SELVA (2101CA10120)

for completing the Certificate / Diploma course on “Designing

[Photoshop, Premium, Illustrator]” From 17/07/2023 To 13/09/2023

In Department of Computer Science , PRIST University, Thanjavur

K. Pinnalathin
Coordinator

Coordinator
Department of Computer Science
School of Arts and Science
Ponnaiyah Ramajayam Institute of
Science and Technology (PRIST)
Thanjavur - 613 403.

Dean

DEAN
School of Arts & Science
Ponnaiyah Ramajayam Institute of
Science & Technology (PRIST)
Deemed to be University
Vallam, Thanjavur - 613 403.





PONNAIYAH RAMAJAYAM INSTITUTE OF
SCIENCE & TECHNOLOGY (PRIST)

Declared as DEEMED-TO-BE-UNIVERSITY
U/s 3 of UGC Act, 1956

CERTIFICATE

THIS IS PRESENTED TO

R.SANTHOSH (2101CA10121)

for completing the Certificate / Diploma course on “Designing

[Photoshop, Premium, Illustrator]” From 17/07/2023 To 13/09/2023

In Department of Computer Science , PRIST University, Thanjavur

K. Prasadharan
Coordinator

HOD
Department of Computer Science
School of Arts and Science
Ponnaiyah Ramajayam Institute of
Science and Technology (PRIST)
Thanjavur - 613 403.

Dean

DEAN
School of Arts & Science
Ponnaiyah Ramajayam Institute of
Science & Technology (PRIST)
Deemed to be University
Thanjavur - 613 403.





PONNAIYAH RAMAJAYAM INSTITUTE OF
SCIENCE & TECHNOLOGY (PRIST)

Declared as DEEMED-TO-BE-UNIVERSITY
U/s 3 of UGC Act, 1956

CERTIFICATE

THIS IS PRESENTED TO

U.GOKUL (2101CA10122)

for completing the Certificate / Diploma course on “Designing

[Photoshop, Premium, Illustrator]” From 17/07/2023 To 13/09/2023

In Department of Computer Science , PRIST University, Thanjavur

K. P. Srinivasan
Coordinator

[Signature]
HOD
Department of Computer Science
School of Arts and Science
Ponnaiyah Ramajayam Institute of
Science and Technology (PRIST)
Thanjavur - 613 403.

[Signature]
Dean
DEAN
School of Arts & Science
Ponnaiyah Ramajayam Institute of
Science & Technology (PRIST)
Deemed to be University
Valiam, Thanjavur - 613 403.



PONNAIYAH RAMAJAYAM INSTITUTE OF
SCIENCE & TECHNOLOGY (PRIST)

Declared as DEEMED-TO-BE-UNIVERSITY
U/s 3 of UGC Act, 1956

CERTIFICATE

THIS IS PRESENTED TO

T.HARI HARA SUDHAN (2101CA10123)

for completing the Certificate / Diploma course on “Designing

[Photoshop, Premium, Illustrator]” From 17/07/2023 To 13/09/2023

In Department of Computer Science , PRIST University, Thanjavur

K. Pinnalethu
Coordinator

HOD

Department of Computer Science
School of Arts and Science
Ponnaiyah Ramajayam Institute of
Science and Technology (PRIST)
Thanjavur - 613 403.

Dean

DEAN
School of Arts & Science
Ponnaiyah Ramajayam Institute of
Science & Technology (PRIST)
Deemed to be University
Valam, Thanjavur - 613 403.



PONNAIYAH RAMAJAYAM INSTITUTE OF
SCIENCE & TECHNOLOGY (PRIST)

Declared as DEEMED-TO-BE-UNIVERSITY
U/s 3 of UGC Act, 1956

CERTIFICATE

THIS IS PRESENTED TO

P.AKASH (2101CA10124)

for completing the Certificate / Diploma course on “Designing

[Photoshop, Premium, Illustrator]” From 17/07/2023 To 13/09/2023

In Department of Computer Science , PRIST University, Thanjavur

K. P. Prasad
Coordinator

HOD

Department of Computer Science
School of Arts and Science
Ponnaiyah Ramajayam Institute of
Science and Technology (PRIST)
Thanjavur - 613 403.

Dean

DEAN
School of Arts & Science
Ponnaiyah Ramajayam Institute of
Science & Technology (PRIST)
Deemed to be University
Valuram, Thanjavur - 613 403.





PONNAIYAH RAMAJAYAM INSTITUTE OF
SCIENCE & TECHNOLOGY (PRIST)

Declared as DEEMED-TO-BE-UNIVERSITY
U/s 3 of UGC Act, 1956

CERTIFICATE

THIS IS PRESENTED TO

M.AHILESHWARAN (2101CA10125)

for completing the Certificate / Diploma course on “Designing

[Photoshop, Premium, Illustrator]” From 17/07/2023 To 13/09/2023

In Department of Computer Science , PRIST University, Thanjavur

K. P. Prasad
Coordinator

HOD

Department of Computer Science
School of Arts and Science
Ponnaiyah Ramajayam Institute of
Science and Technology (PRIST)
Thanjavur - 613 403.

Dean

DEAN
School of Arts & Science
Ponnaiyah Ramajayam Institute of
Science & Technology (PRIST)
Deemed to be University
Valiam, Thanjavur - 613 403.

PONNAIYAH RAMAJAYAM INSTITUTE OF
SCIENCE & TECHNOLOGY (PRIST)

Declared as DEEMED TO BE UNIVERSITY
U/s 3 of UGC Act, 1956



CERTIFICATE

THIS IS PRESENTED TO

J. MUKESH RAO (2101CA10126)

for completing the Certificate / Diploma course on "Designing

[Photoshop, Premium, Illustrator]" From 17/07/2023 To 13/09/2023

In Department of Computer Science, PRIST University, Thanjavur

K. P. ...
Coordinator

Department of Computer Science
School of Arts and Science
Ponnaiyah Ramajayam Institute of
Science and Technology (PRIST)
Thanjavur - 613 403.

J. ...
HOD

J. ...
Dean

School of Arts & Science
Ponnaiyah Ramajayam Institute of
Science & Technology (PRIST)
Deemed to be University
Thanjavur - 613 403.





PONNAIYAH RAMAJAYAM INSTITUTE OF
SCIENCE & TECHNOLOGY (PRIST)

Declared as DEEMED-TO-BE-UNIVERSITY
U/s 3 of UGC Act, 1956

CERTIFICATE

THIS IS PRESENTED TO

GURUPRASATH K (2101CA10127)

for completing the Certificate / Diploma course on “Designing

[Photoshop, Premium, Illustrator]” From 17/07/2023 To 13/09/2023

In Department of Computer Science , PRIST University, Thanjavur

K. P. Prasad
Coordinator

[Signature]
HOD
Department of Computer Science
School of Arts and Science
Ponnaiyah Ramajayam Institute of
Science and Technology (PRIST)
Thanjavur - 613 403.

[Signature]
DEAN
Dean
School of Arts & Science
Ponnaiyah Ramajayam Institute of
Science & Technology (PRIST)
Deemed to be University
Vallam, Thanjavur - 613 403.



PONNAIYAH RAMAJAYAM INSTITUTE OF
SCIENCE & TECHNOLOGY (PRIST)

Declared as DEEMED-TO-BE-UNIVERSITY
U/s 3 of UGC Act, 1956

CERTIFICATE

THIS IS PRESENTED TO

S.HARIHARAN (2101CA10128)

for completing the Certificate / Diploma course on “Designing

[Photoshop, Premium, Illustrator]” From 17/07/2023 To 13/09/2023

In Department of Computer Science , PRIST University, Thanjavur

K. Pinnalathin
Coordinator

Department of Computer Science
School of Arts and Science
Ponnaiyah Ramajayam Institute of
Science and Technology (PRIST)
Thanjavur - 613 403.

DEAN
Dean
School of Arts & Science
Ponnaiyah Ramajayam Institute
Science & Technology (PRIST,
Deemed to be University
Valiam, Thanjavur - 613 403.





PONNAIYAH RAMAJAYAM INSTITUTE OF
SCIENCE & TECHNOLOGY (PRIST)

Declared as DEEMED-TO-BE-UNIVERSITY
U/s 3 of UGC Act, 1956

CERTIFICATE

THIS IS PRESENTED TO

M.THINAKARAN (2101CA10109)

for completing the Certificate / Diploma course on “Designing

[Photoshop, Premium, Illustrator]” From 17/07/2023 To 13/09/2023

In Department of Computer Science , PRIST University, Thanjavur

K. P. Senthil Kumar
Coordinator

[Signature]
HOD
Department of Computer Science
School of Arts and Science
Ponnaiyah Ramajayam Institute of
Science and Technology (PRIST)
Thanjavur - 613 403.

[Signature]
DEAN
School of Arts & Science
Ponnaiyah Ramajayam Institute of
Science & Technology (PRIST)
Deemed to be University
Vellam, Thanjavur - 613 403.





PONNAIYAH RAMAJAYAM INSTITUTE OF
SCIENCE & TECHNOLOGY (PRIST)

Declared as DEEMED-TO-BE-UNIVERSITY
U/s 3 of UGC Act, 1956



CERTIFICATE

THIS IS PRESENTED TO
AARTHI R (2201CA10216)

*for completing the Certificate / Diploma course on “Introduction to
Cyber Security and Cyber Attacks” From 23/01/2024 To 14/03/2024 In*

Department of Computer Science , PRIST University, Thanjavur

K. P. ...

Coordinator

HOD

Department of Computer Science
School of Arts and Science
Ponnaiyah Ramajayam Institute of
Science and Technology (PRIST)
Thanjavur - 613 403.

Dean

DEAN
School of Arts & Science
Ponnaiyah Ramajayam Institute of
Science & Technology (PRIST)
Deemed to be University
Thanjavur - 613 403.



PONNAIYAH RAMAJAYAM INSTITUTE OF
SCIENCE & TECHNOLOGY (PRIST)

Declared as DEEMED-TO-BE-UNIVERSITY
U/s 3 of UGC Act, 1956



CERTIFICATE

THIS IS PRESENTED TO

AARTHI K (2201CA10215)

*for completing the Certificate / Diploma course on “Introduction to
Cyber Security and Cyber Attacks” From 23/01/2024 To 14/03/2024 In
Department of Computer Science , PRIST University, Thanjavur*

K. Pinnalabai
Coordinator

[Signature]
HOD
Department of Computer Science
School of Arts and Science
Ponnaiyah Ramajayam Institute of
Science and Technology (PRIST)
Thanjavur - 613 403.

[Signature]
Dean

DEAN
School of Arts & Science
Ponnaiyah Ramajayam Institute of
Science & Technology (PRIST)
Deemed to be University
Vallam, Thanjavur - 613 403.



PONNAIYAH RAMAJAYAM INSTITUTE OF
SCIENCE & TECHNOLOGY (PRIST)

Declared as DEEMED-TO-BE-UNIVERSITY
U/s 3 of UGC Act, 1956



CERTIFICATE

THIS IS PRESENTED TO

KAVITHA R (2201CA10214)

*for completing the Certificate / Diploma course on “Introduction to
Cyber Security and Cyber Attacks” From 23/01/2024 To 14/03/2024 In
Department of Computer Science , PRIST University, Thanjavur*

K. P. ...

Coordinator

HOD

Department of Computer Science
School of Arts and Science
Ponnaiyah Ramajayam Institute of
Science and Technology (PRIST)
Thanjavur - 613 403.

Dean

DEAN

School of Arts & Science
Ponnaiyah Ramajayam Institute of
Science & Technology (PRIST)
Deemed to be University
Valiam, Thanjavur - 613 403.



PONNAIYAH RAMAJAYAM INSTITUTE OF
SCIENCE & TECHNOLOGY (PRIST)

Declared as DEEMED-TO-BE-UNIVERSITY
U/s 3 of UGC Act, 1956



CERTIFICATE

THIS IS PRESENTED TO

ATCHAYA R (2201CA10213)

*for completing the Certificate / Diploma course on “Introduction to
Cyber Security and Cyber Attacks” From 23/01/2024 To 14/03/2024 In*

Department of Computer Science , PRIST University, Thanjavur

K. Pinnalalan

Coordinator

HOD

Department of Computer Science
School of Arts and Science
Ponnaiyah Ramajayam Institute of
Science and Technology (PRIST)
Thanjavur - 613 403.

Dean

DEAN

School of Arts & Science
Ponnaiyah Ramajayam Institute of
Science & Technology (PRIST)
Deemed to be University
Thanjavur - 613 403.



PONNAIYAH RAMAJAYAM INSTITUTE OF
SCIENCE & TECHNOLOGY (PRIST)

Declared as DEEMED-TO-BE-UNIVERSITY
U/s 3 of UGC Act, 1956



CERTIFICATE

THIS IS PRESENTED TO

JENIFER M (2201CA10212)

*for completing the Certificate / Diploma course on “Introduction to
Cyber Security and Cyber Attacks” From 23/01/2024 To 14/03/2024 In*

Department of Computer Science , PRIST University, Thanjavur

K. P. ...

Coordinator

HOD

Department of Computer Science
School of Arts and Science
Ponnaiyah Ramajayam Institute of
Science and Technology (PRIST)
Thanjavur - 613 403.

Dean

DEAN

School of Arts & Science
Ponnaiyah Ramajayam Institute of
Science & Technology (PRIST)
Deemed to be University
Vallam, Thanjavur - 613 403.



PONNAIYAH RAMAJAYAM INSTITUTE OF
SCIENCE & TECHNOLOGY (PRIST)

Declared as DEEMED-TO-BE-UNIVERSITY
U/s 3 of UGC Act, 1956



CERTIFICATE

THIS IS PRESENTED TO

AMEERA S (2201CA10211)

*for completing the Certificate / Diploma course on “Introduction to
Cyber Security and Cyber Attacks” From 23/01/2024 To 14/03/2024 In*

Department of Computer Science , PRIST University, Thanjavur

K. P. ...

Coordinator

HOD

Department of Computer Science
School of Arts and Science
Ponnaiyah Ramajayam Institute of
Science and Technology (PRIST)
Thanjavur - 613 403.

DEAN

Dean

School of Arts & Science
Ponnaiyah Ramajayam Institute of
Science & Technology (PRIST)
Deemed to be University
Vallam, Thanjavur - 613 403.



PONNAIYAH RAMAJAYAM INSTITUTE OF
SCIENCE & TECHNOLOGY (PRIST)

Declared as DEEMED-TO-BE-UNIVERSITY
U/s 3 of UGC Act, 1956



CERTIFICATE

THIS IS PRESENTED TO

KEERTHIKA M (2201CA10208)

*for completing the Certificate / Diploma course on “Introduction to
Cyber Security and Cyber Attacks” From 23/01/2024 To 14/03/2024 In*

Department of Computer Science , PRIST University, Thanjavur

K. P. ...

Coordinator

HOD
Department of Computer Science
School of Arts and Science
Ponnaiyah Ramajayam Institute of
Science and Technology (PRIST)
Thanjavur - 613 403.

Dean

DEAN
School of Arts & Science
Ponnaiyah Ramajayam Institute of
Science & Technology (PRIST)
Deemed to be University
Vallam, Thanjavur - 613 403.

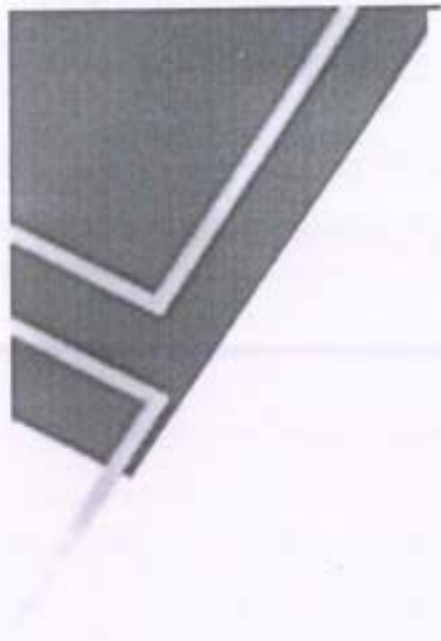

**PONNAIYAH RAMAJAYAM INSTITUTE OF
SCIENCE & TECHNOLOGY (PRIST)**

Declared as DEEMED-TO-BE-UNIVERSITY
U/s 3 of UGC Act, 1956



CERTIFICATE

THIS IS PRESENTED TO

RANJISRI S (2201CA10209)

for completing the Certificate / Diploma course on **“Introduction to
Cyber Security and Cyber Attacks”** From 23/01/2024 To 14/03/2024 In

Department of Computer Science , PRIST University, Thanjavur

K. Pinnalathar

Coordinator

HOD

Department of Computer Science
School of Arts and Science
Ponnaiyah Ramajayam Institute of
Science and Technology (PRIST)
Thanjavur - 813 403.

Dean

DEAN
School of Arts & Science
Ponnaiyah Ramajayam Institute of
Science and Technology (PRIST)
Thanjavur - 813 403.



PONNAIYAH RAMAJAYAM INSTITUTE OF
SCIENCE & TECHNOLOGY (PRIST)

Declared as DEEMED-TO-BE-UNIVERSITY
U/s 3 of UGC Act, 1956



CERTIFICATE

THIS IS PRESENTED TO
USHA J (2201CA10217)

*for completing the Certificate / Diploma course on “Introduction to
Cyber Security and Cyber Attacks” From 23/01/2024 To 14/03/2024 In*

Department of Computer Science , PRIST University, Thanjavur

K. P. ...

Coordinator

HOD

Department of Computer Science
School of Arts and Science
Ponnaiyah Ramajayam Institute of
Science and Technology (PRIST)
Thanjavur - 613 403.

Dean

DEAN
School of Arts & Science
Ponnaiyah Ramajayam Institute of
Science & Technology (PRIST)
Deemed to be University
Vailam, Thanjavur - 613 403.



PONNAIYAH RAMAJAYAM INSTITUTE OF
SCIENCE & TECHNOLOGY (PRIST)

Declared as DEEMED-TO-BE-UNIVERSITY
U/s 3 of UGC Act, 1956



CERTIFICATE

THIS IS PRESENTED TO

GAYATHRI L (2201CA10218)

for completing the Certificate / Diploma course on **“Introduction to
Cyber Security and Cyber Attacks”** From 23/01/2024 To 14/03/2024 In
Department of Computer Science , PRIST University, Thanjavur

K. P. S. S. S.

Coordinator

HOD

Department of Computer Science
School of Arts and Science
Ponnaiyah Ramajayam Institute of
Science and Technology (PRIST)
Thanjavur - 813 403.

DEAN

Dean

School of Arts & Science
Ponnaiyah Ramajayam Inst.
Science & Technology (PRIST)
Deemed to be University
Vellam, Thanjavur - 813 403.



PONNAIYAH RAMAJAYAM INSTITUTE OF
SCIENCE & TECHNOLOGY (PRIST)

Declared as DEEMED-TO-BE-UNIVERSITY
U/s 3 of UGC Act, 1956



CERTIFICATE

THIS IS PRESENTED TO

PRIYA H (2201CA10219)

for completing the Certificate / Diploma course on **“Introduction to
Cyber Security and Cyber Attacks”** From 23/01/2024 To 14/03/2024 In

Department of Computer Science , PRIST University, Thanjavur

K. Pinnalathas
Coordinator

[Signature]
HOD
Department of Computer Science
School of Arts and Science
Ponnaiyah Ramajayam Institute of
Science and Technology (PRIST)
Thanjavur - 613 403

[Signature]
DEAN **Dean**
School of Arts & Science
Ponnaiyah Ramajayam Institute of
Science and Technology (PRIST)
Deemed to be University
Thanjavur, Thanjavur - 613 403



PONNAIYAH RAMAJAYAM INSTITUTE OF
SCIENCE & TECHNOLOGY (PRIST)

Declared as DEEMED-TO-BE-UNIVERSITY
U/s 3 of UGC Act, 1956



CERTIFICATE

THIS IS PRESENTED TO

ABDUR RAHMAN A (2201CA10101)

for completing the Certificate / Diploma course on "Google IT

Support" From 23/01/2024 To 14/03/2024 In Department of Computer

Science , PRIST University, Thanjavur

K. P. Prasad

Coordinator

[Signature]

HOD

Department of Computer Science
School of Arts and Science
Ponnaiyah Ramajayam Institute of
Science and Technology (PRIST)
Thanjavur - 613 403.

[Signature]

DEAN

Dean

School of Arts & Science
Ponnaiyah Ramajayam Institute of
Science & Technology (PRIST)
Deemed to be University
Vellam, Thanjavur - 613 403.



**PONNAIYAH RAMAJAYAM INSTITUTE OF
SCIENCE & TECHNOLOGY (PRIST)**

Declared as DEEMED-TO-BE-UNIVERSITY
U/s 3 of UGC Act, 1956

CERTIFICATE

THIS IS PRESENTED TO

VISHVA GANESH J (2201CA10103)



for completing the Certificate / Diploma course on “Google IT

Support” From 23/01/2024 To 14/03/2024 In Department of Computer

Science , PRIST University, Thanjavur

K. Pinaraj

Coordinator

HOD
Department of Computer Science
School of Arts and Science
Ponnaiyah Ramajayam Institute of
Science and Technology (PRIST)
Thanjavur - 613 403.

Dean

DEAN
School of Arts & Science
Ponnaiyah Ramajayam Institute of
Science & Technology (PRIST)
Deemed to be University
Thanjavur - 613 403.



PONNAIYAH RAMAJAYAM INSTITUTE OF
SCIENCE & TECHNOLOGY (PRIST)

Declared as DEEMED-TO-BE UNIVERSITY
U/s 3 of UGC Act, 1956

CERTIFICATE

THIS IS PRESENTED TO

DINESH R (2201CA10105)



for completing the Certificate / Diploma course on “Google IT

Support” From 23/01/2024 To 14/03/2024 In Department of Computer

Science , PRIST University, Thanjavur

K. P. Senthil Kumar
Coordinator

[Signature]
HOD
Department of Computer Science
School of Arts and Science
Ponnaiyah Ramajayam Institute of
Science and Technology (PRIST)
Thanjavur - 613 403.

[Signature]
Dean

DEAN
School of Arts & Science
Ponnaiyah Ramajayam Institute of
Science & Technology (PRIST)
Deemed to be University
Vellore, Thanjavur - 613 403.



PONNAIYAH RAMAJAYAM INSTITUTE OF
SCIENCE & TECHNOLOGY (PRIST)

Declared as DEEMED-TO-BE-UNIVERSITY
U/s 3 of UGC Act, 1956

CERTIFICATE

THIS IS PRESENTED TO

ELAKIYAN I (2201CA10106)



for completing the Certificate / Diploma course on "Google IT

Support" From 23/01/2024 To 14/03/2024 In Department of Computer

Science , PRIST University, Thanjavur

K. Prasad
Coordinator

HOD
Department of Computer Science
School of Arts and Science
Ponnaiyah Ramajayam Institute of
Science and Technology (PRIST)
Thanjavur - 613 403.

[Signature]
Dean

DEAN
School of Arts & Science
Ponnaiyah Ramajayam Institute of
Science & Technology (PRIST)
Deemed to be University
Vallam, Thanjavur - 613 403.



**PONNAIYAH RAMAJAYAM INSTITUTE OF
SCIENCE & TECHNOLOGY (PRIST)**

Declared as DEEMED TO BE UNIVERSITY
U/s 3 of UGC Act, 1956

CERTIFICATE

THIS IS PRESENTED TO

SANJAY KUMAR S (2201CA10107)



for completing the Certificate / Diploma course on “Google IT

Support” From 23/01/2024 To 14/03/2024 In Department of Computer

Science , PRIST University, Thanjavur

K. P. ...

Coordinator

[Signature]

HOD
Department of Computer Science
School of Arts and Science
Ponnaiyah Ramajayam Institute of
Science and Technology (PRIST)
Thanjavur - 613 403.

[Signature]

Dean

DEAN
School of Arts & Science
Ponnaiyah Ramajayam Institute of
Science & Technology (PRIST)
Deemed to be University
Thanjavur - 613 403.



**PONNAIYAH RAMAJAYAM INSTITUTE OF
SCIENCE & TECHNOLOGY (PRIST)**

Declared as DEEMED-TO-BE-UNIVERSITY
U/s 3 of UGC Act, 1956

CERTIFICATE

THIS IS PRESENTED TO

MOHAMED MANAS J (2201CA10109)



for completing the Certificate / Diploma course on "Google IT

Support" From 23/01/2024 To 14/03/2024 In Department of Computer

Science , PRIST University, Thanjavur

K. Pinnalathin
Coordinator

HOD
Department of Computer Science
School of Arts and Science
Ponnaiyah Ramajayam Institute of
Science and Technology (PRIST)
Thanjavur - 613 403.

DEAN
Ponnaiyah Ramajayam Institute of
Science & Technology (PRIST)
Deemed to be University
Vallam, Thanjavur - 613 403.





PONNAIYAH RAMAJAYAM INSTITUTE OF
SCIENCE & TECHNOLOGY (PRIST)

Declared as DEEMED-TO-BE-UNIVERSITY
U/s 3 of UGC Act, 1956

CERTIFICATE

THIS IS PRESENTED TO

[OHAMED AFIR ABU MUMEEN M (2201CA10110)

for completing the Certificate / Diploma course on "Google IT

Support" From 23/01/2024 To 14/03/2024 In Department of Computer

Science , PRIST University, Thanjavur

K. Pinnalathin
Coordinator

[Signature]
HOD
Department of Computer Science
School of Arts and Science
Ponnaiyah Ramajayam Institute of
Science and Technology (PRIST)
Thanjavur - 613 403.

[Signature]
Dean
School of Arts & Science
Ponnaiyah Ramajayam Institute of
Science & Technology (PRIST)
Deemed to be University
Vallam, Thanjavur - 613 403.

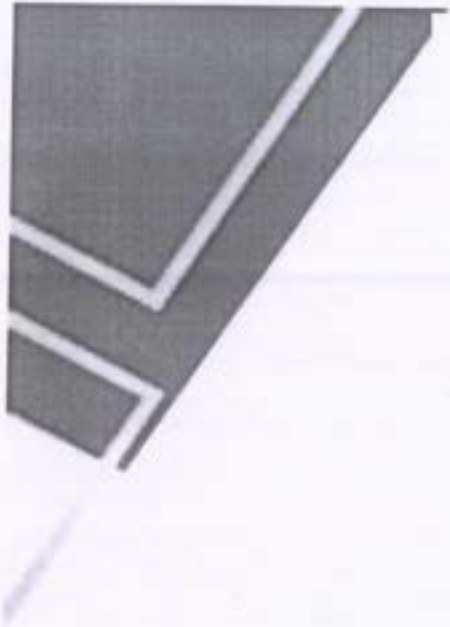

PONNAIYAH RAMAJAYAM INSTITUTE OF SCIENCE & TECHNOLOGY (PRIST)

Declared as DEEMED TO BE UNIVERSITY U/s 3 of UGC Act, 1956

CERTIFICATE

THIS IS PRESENTED TO

MOHAMED THOUFIC S (2201CA10112)



for completing the Certificate / Diploma course on “Google IT

Support” From 23/01/2024 To 14/03/2024 In Department of Computer

Science , PRIST University, Thanjavur

K. Prasadharan

Coordinator

HOD

Department of Computer Science
School of Arts and Science
Ponnaiyah Ramajayam Institute of
Science and Technology (PRIST)
Thanjavur - 613 403.

Dean

DEAN

School of Arts & Science
Ponnaiyah Ramajayam Institute of
Science & Technology (PRIST)
Deemed to be University
Vallem, Thanjavur - 613 403.



**PONNAIYAH RAMAJAYAM INSTITUTE OF
SCIENCE & TECHNOLOGY (PRIST)**

Declared as DEEMED-TO-BE-UNIVERSITY
U/s 3 of UGC Act, 1956

CERTIFICATE

THIS IS PRESENTED TO

MANOJ S (2201CA10113)

for completing the Certificate / Diploma course on “Google IT

Support” From 23/01/2024 To 14/03/2024 In Department of Computer

Science , PRIST University, Thanjavur

K. Prasad
Coordinator

HOD
Department of Computer Science
School of Arts and Science
Ponnaiyah Ramajayam Institute of
Science and Technology (PRIST)
Thanjavur - 613 403.

[Signature]
Dean

DEAN
School of Arts & Science
Ponnaiyah Ramajayam Institute of
Science & Technology (PRIST)
Deemed to be University
Vallam, Thanjavur - 613 403.



PONNAIYAH RAMAJAYAM INSTITUTE OF
SCIENCE & TECHNOLOGY (PRIST)

Declared as DEEMED-TO-BE-UNIVERSITY
U/s 3 of UGC Act, 1956

CERTIFICATE

THIS IS PRESENTED TO

MOHAMED IMRAN J (2201CA10114)

for completing the Certificate / Diploma course on “Google IT

Support” From 23/01/2024 To 14/03/2024 In Department of Computer

Science , PRIST University, Thanjavur

K. P. Senthil Kumar
Coordinator

HOD
Department of Computer Science
School of Arts and Science
Ponnaiyah Ramajayam Institute of
Science and Technology (PRIST)
Thanjavur - 613 403.

[Signature]
Dean

DEAN
School of Arts & Science
Ponnaiyah Ramajayam Institute of
Science & Technology (PRIST)
Deemed to be University
Valliam, Thanjavur - 613 403.



PONNAIYAH RAMAJAYAM INSTITUTE OF
SCIENCE & TECHNOLOGY (PRIST)

Declared as DEEMED-TO-BE-UNIVERSITY
U/s 3 of UGC Act, 1956

CERTIFICATE

THIS IS PRESENTED TO

SRIRAM (2201CA10116)

for completing the Certificate / Diploma course on “Google IT

Support” From 23/01/2024 To 14/03/2024 In Department of Computer

Science , PRIST University, Thanjavur

K. P. Prasad
Coordinator

[Signature]
HOD
Department of Computer Science
School of Arts and Science
Ponnaiyah Ramajayam Institute of
Science and Technology (PRIST)
Thanjavur - 613 403.

[Signature]
Dean

[Signature]
DEAN
School of Arts & Science
Ponnaiyah Ramajayam Institute of
Science & Technology (PRIST)
Deemed to be University
Ve: n, Thanjavur - 613 403.



**PONNAIYAH RAMAJAYAM INSTITUTE OF
SCIENCE & TECHNOLOGY (PRIST)**
Declared as DEEMED-TO-BE-UNIVERSITY
U/s 3 of UGC Act, 1956

CERTIFICATE

THIS IS PRESENTED TO

ABINESH A (2201CA10117)



for completing the Certificate / Diploma course on “Google IT

Support” From 23/01/2024 To 14/03/2024 In Department of Computer

Science , PRIST University, Thanjavur

K. Pinnalathu
Coordinator

HOD
Department of Computer Science
School of Arts and Science
Ponnaiyah Ramajayam Institute of
Science and Technology (PRIST)
Thanjavur - 613 403.

[Handwritten Signature]
Dean

DEAN
School of Arts & Science,
Ponnaiyah Ramajayam Institute of
Science & Technology (PRIST)
Deemed to be University,
Vallam, Thanjavur - 613 403.



PONNAIYAH RAMAJAYAM INSTITUTE OF
SCIENCE & TECHNOLOGY (PRIST)

Declared as DEEMED-TO-BE-UNIVERSITY
U/s 3 of UGC Act, 1956

CERTIFICATE

THIS IS PRESENTED TO

HARISH G (2201CA10118)



for completing the Certificate / Diploma course on “Google IT

Support” From 23/01/2024 To 14/03/2024 In Department of Computer

Science , PRIST University, Thanjavur

K. P. Prasad

Coordinator

[Signature]

HOD

Department of Computer Science
School of Arts and Science
Ponnaiyah Ramajayam Institute of
Science and Technology (PRIST)
Thanjavur - 613 403.

[Signature]

Dean

DEAN
School of Arts & Science
Ponnaiyah Ramajayam Institute of
Science & Technology (PRIST)
Deemed to be University
Vallam, Thanjavur - 613 403.



PONNAIYAH RAMAJAYAM INSTITUTE OF
SCIENCE & TECHNOLOGY (PRIST)

Declared as DEEMED-TO-BE-UNIVERSITY
U/s 3 of UGC Act, 1956

CERTIFICATE

THIS IS PRESENTED TO

SURENTHARAN K (2201CA10119)



for completing the Certificate / Diploma course on "Google IT

Support" From 23/01/2024 To 14/03/2024 In Department of Computer

Science , PRIST University, Thanjavur

K. Prasad
Coordinator

[Signature]
HOD
Department of Computer Science
School of Arts and Science
Ponnaiyah Ramajayam Institute of
Science and Technology (PRIST)
Thanjavur - 613 403.

[Signature]
Dean
DEAN
School of Arts & Science
Ponnaiyah Ramajayam Institute of
Science & Technology (PRIST)
Deemed to be University
Vallam, Thanjavur - 613 403.



PONNAIYAH RAMAJAYAM INSTITUTE OF
SCIENCE & TECHNOLOGY (PRIST)

Declared as DEEMED-TO-BE-UNIVERSITY
U/s 3 of UGC Act, 1956

CERTIFICATE

THIS IS PRESENTED TO

SUNIL KUMAR M (2201CA10120)



for completing the Certificate / Diploma course on “Google IT

Support” From 23/01/2024 To 14/03/2024 In Department of Computer

Science , PRIST University, Thanjavur

K. Prasad

Coordinator

[Signature]

HOD
Department of Computer Science
School of Arts and Science
Ponnaiyah Ramajayam Institute of
Science and Technology (PRIST)
Thanjavur - 613 403.

[Signature]

DEAN Dean

School of Arts & Science
Ponnaiyah Ramajayam Institute of
Science & Technology (PRIST)
Deemed to be University
Vallam, Thanjavur - 613 403.

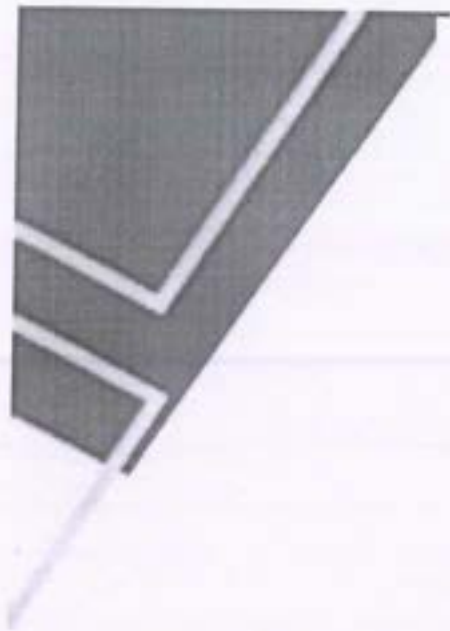

PONNAIYAH RAMAJAYAM INSTITUTE OF
SCIENCE & TECHNOLOGY (PRIST)

Declared as DEEMED-TO-BE-UNIVERSITY
U/s 3 of UGC Act, 1956



CERTIFICATE

THIS IS PRESENTED TO

DHANESH PRABU (2201CA10121)

for completing the Certificate / Diploma course on "Google IT

Support" From 23/01/2024 To 14/03/2024 In Department of Computer

Science , PRIST University, Thanjavur

K. Pinnathala

Coordinator

[Signature]

HOD,

Department of Computer Science
Department of Computer Science
School of Arts and Science
Ponnaiyah Ramajayam Institute of
Science and Technology (PRIST)
Thanjavur - 613 403.

[Signature]

DEAN

Dean

School of Arts & Science
Ponnaiyah Ramajayam Institute of
Science & Technology (PRIST)
Deemed to be University
Thanjavur, Thanjavur - 613 403.





PONNAIYAH RAMAJAYAM INSTITUTE OF
SCIENCE & TECHNOLOGY (PRIST)

Declared as DEEMED-TO-BE-UNIVERSITY
U/s 3 of UGC Act, 1956

CERTIFICATE

THIS IS PRESENTED TO

PRAVIN V (2201CA10123)



for completing the Certificate / Diploma course on “Google IT

Support” From 23/01/2024 To 14/03/2024 In Department of Computer

Science , PRIST University, Thanjavur

K. Praveen Kumar

Coordinator

[Signature]

HOD

Department of Computer Science
School of Arts and Science
Ponnaiyah Ramajayam Institute of
Science and Technology (PRIST)
Thanjavur - 613 403.

[Signature]

Dean

DEAN

School of Arts & Science
Ponnaiyah Ramajayam Institute of
Science & Technology (PRIST)
Deemed to be University
Vallam, Thanjavur - 613 403.



PONNAIYAH RAMAJAYAM INSTITUTE OF
SCIENCE & TECHNOLOGY (PRIST)

Declared as DEEMED-TO-BE UNIVERSITY
U/s 3 of UGC Act, 1956

CERTIFICATE

THIS IS PRESENTED TO

SHESHATHIRY R (2201CA10125)



for completing the Certificate / Diploma course on “Google IT

Support” From 23/01/2024 To 14/03/2024 In Department of Computer

Science , PRIST University, Thanjavur

K. Prasad
Coordinator

[Signature]
HOD
Department of Computer Science
School of Arts and Science
Ponnaiyah Ramajayam Institute of
Science and Technology (PRIST)
Thanjavur - 613 403.

[Signature]
DEAN Dean
School of Arts & Science
Ponnaiyah Ramajayam Institute of
Science & Technology (PRIST)
Deemed to be University
Vellur, Thanjavur - 613 403.



**PONNAIYAH RAMAJAYAM INSTITUTE OF
SCIENCE & TECHNOLOGY (PRIST)**

Declared as DEEMED-TO-BE-UNIVERSITY
U/s 3 of UGC Act, 1956

CERTIFICATE

THIS IS PRESENTED TO

SATHISH P (2201CA10126)



for completing the Certificate / Diploma course on “Google IT

Support” From 23/01/2024 To 14/03/2024 In Department of Computer

Science , PRIST University, Thanjavur

K. Prasad
Coordinator

[Signature]
HOD
Department of Computer Science
School of Arts and Science
Ponnaiyah Ramajayam Institute of
Science and Technology (PRIST)
Thanjavur - 613 403.

[Signature]
DEAN **Dean**
School of Arts & Science
Ponnaiyah Ramajayam Institute of
Science & Technology (PRIST)
Deemed to be University
Vallam, Thanjavur - 613 403.



PONNAIYAH RAMAJAYAM INSTITUTE OF
SCIENCE & TECHNOLOGY (PRIST)

Declared as DEEMED-TO-BE UNIVERSITY
U/s 3 of UGC Act, 1956

CERTIFICATE

THIS IS PRESENTED TO

LOGESHWARA S (2201CA10127)



for completing the Certificate / Diploma course on "Google IT

Support" From 23/01/2024 To 14/03/2024 In Department of Computer

Science , PRIST University, Thanjavur

K. P. Prasad
Coordinator

[Signature]
HOD
Department of Computer Science
School of Arts and Science
Ponnaiyah Ramajayam Institute of
Science and Technology (PRIST)
Thanjavur - 613 403.

[Signature]
Dean
DEAN
School of Arts & Science
Ponnaiyah Ramajayam Institute of
Science & Technology (PRIST)
Deemed to be University
Vallam, Thanjavur - 613 403.



PONNAIYAH RAMAJAYAM INSTITUTE OF SCIENCE & TECHNOLOGY (PRIST)

Declared as DEEMED-TO-BE-UNIVERSITY U/s 3 of UGC Act, 1956

CERTIFICATE

THIS IS PRESENTED TO

PRAGADESH K S (2201CA10128)



for completing the Certificate / Diploma course on "Google IT

Support" From 23/01/2024 To 14/03/2024 In Department of Computer

Science , PRIST University, Thanjavur

K. P. Prasad
Coordinator

HOD
Department of Computer Science
School of Arts and Science
Ponnaiyah Ramajayam Institute of
Science and Technology (PRIST)
Thanjavur - 613 403.

Dean

DEAN
School of Arts & Science
Ponnaiyah Ramajayam Institute of
Science & Technology (PRIST)
Deemed to be University
Vallam, Thanjavur - 613 403.



PONNAIYAH RAMAJAYAM INSTITUTE OF
SCIENCE & TECHNOLOGY (PRIST)

Declared as DEEMED-TO-BE-UNIVERSITY
U/s 3 of UGC Act, 1956

CERTIFICATE

THIS IS PRESENTED TO

MANIMARAN A (2201CA10129)



for completing the Certificate / Diploma course on "Google IT

Support" From 23/01/2024 To 14/03/2024 In Department of Computer

Science , PRIST University, Thanjavur

K. Pinnalathar

Coordinator

HOD

Department of Computer Science
School of Arts and Science
Ponnaiyah Ramajayam Institute of
Science and Technology (PRIST)
Thanjavur - 613 403.

Dean

DEAN

School of Arts & Science
Ponnaiyah Ramajayam Institute of
Science & Technology (PRIST)
Deemed to be University
Illam, Thanjavur - 613 403.



**PONNAIYAH RAMAJAYAM INSTITUTE OF
SCIENCE & TECHNOLOGY (PRIST)**

Declared as DEEMED-TO-BE-UNIVERSITY
U/s 3 of UGC Act, 1956

CERTIFICATE

THIS IS PRESENTED TO

NITHISH KUMAR T (2201CA10131)

for completing the Certificate / Diploma course on “Google IT

Support” From 23/01/2024 To 14/03/2024 In Department of Computer

Science , PRIST University, Thanjavur

K. P. Prasad

Coordinator

HOD

Department of Computer Science
Department of Computer Science
School of Arts and Science
Ponnaiyah Ramajayam Institute of
Science and Technology (PRIST)
Thanjavur - 613 403.

DEAN

Dean

School of Arts & Science
Ponnaiyah Ramajayam Institute of
Science & Technology (PRIST)
Deemed to be University
Vellam, Thanjavur - 613 403.



PONNAIYAH RAMAJAYAM INSTITUTE OF
SCIENCE & TECHNOLOGY (PRIST)

Declared as DEEMED-TO-BE UNIVERSITY
U/s 3 of UGC Act, 1956

CERTIFICATE

THIS IS PRESENTED TO

BALAJI K (2201CA10132)



for completing the Certificate / Diploma course on “Google IT

Support” From 23/01/2024 To 14/03/2024 In Department of Computer

Science , PRIST University, Thanjavur

K. Pinnalathar
Coordinator

[Signature]
HOD
Department of Computer Science
School of Arts and Science
Ponnaiyah Ramajayam Institute of
Science and Technology (PRIST)
Thanjavur - 613 403.

[Signature]
DEAN Dean
School of Arts & Science
Ponnaiyah Ramajayam Institute of
Science & Technology (PRIST)
Deemed to be University
Vallam, Thanjavur - 613 403.

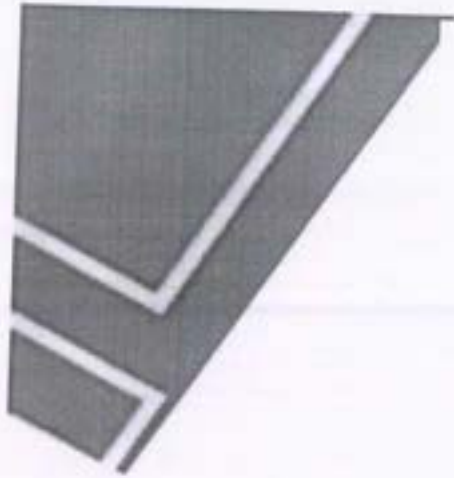

**PONNAIYAH RAMAJAYAM INSTITUTE OF
SCIENCE & TECHNOLOGY (PRIST)**

Declared as DEEMED TO BE UNIVERSITY
U/s 3 of UGC Act, 1956



CERTIFICATE

THIS IS PRESENTED TO

SEENIVASAN M (2201CA10134)

for completing the Certificate / Diploma course on "Google IT

Support" From 23/01/2024 To 14/03/2024 In Department of Computer

Science , PRIST University, Thanjavur

K. Pinnathilagan
Coordinator

HOD
Department of Computer Science
School of Arts and Science
Ponnaiyah Ramajayam Institute of
Science and Technology (PRIST)
Thanjavur - 613 403.

DEAN **Dean**
School of Arts & Science
Ponnaiyah Ramajayam Institute of
Science and Technology (PRIST)
Thanjavur - 613 403.



PONNAIYAH RAMAJAYAM INSTITUTE OF
SCIENCE & TECHNOLOGY (PRIST)

Declared as DEEMED-TO-BE-UNIVERSITY
U/s 3 of UGC Act, 1956



CERTIFICATE

THIS IS PRESENTED TO

KALAIMARAN K (2201CA10133)

for completing the Certificate / Diploma course on “Google IT

Support” From 23/01/2024 To 14/03/2024 In Department of Computer

Science , PRIST University, Thanjavur

K. Prasad
Coordinator

[Signature]
HOD
Department of Computer Science
School of Arts and Science
Ponnaiyah Ramajayam Institute of
Science and Technology (PRIST)
Thanjavur - 613 403.

[Signature]
DEAN **Dean**
School of Arts & Science
Ponnaiyah Ramajayam Institute of
Science & Technology (PRIST)
Deemed to be University
Vallam, Thanjavur - 613 403.



PONNAIYAH RAMAJAYAM INSTITUTE OF
SCIENCE & TECHNOLOGY (PRIST)

Declared as DEEMED-TO-BE-UNIVERSITY
U/s 3 of UGC Act, 1956

CERTIFICATE

THIS IS PRESENTED TO

MOHAMED THOUFIQ M (2201CA10135)

for completing the Certificate / Diploma course on "Google IT

Support" From 23/01/2024 To 14/03/2024 In Department of Computer

Science , PRIST University, Thanjavur

K. Pinnalathin
Coordinator

[Signature]
HOD
Department of Computer Science
School of Arts and Science
Ponnaiyah Ramajayam Institute of
Science and Technology (PRIST)
Thanjavur - 613 403.

[Signature]
DEAN **Dean**
School of Arts & Science
Ponnaiyah Ramajayam Institute of
Science & Technology (PRIST)
Deemed to be University
Thanjavur - 613 403



**PONNAIYAH RAMAJAYAM INSTITUTE OF
SCIENCE & TECHNOLOGY (PRIST)**

Declared as DEEMED-TO-BE-UNIVERSITY
U/s 3 of UGC Act, 1956

CERTIFICATE

THIS IS PRESENTED TO

BALASINGAM (2201CA10136)



for completing the Certificate / Diploma course on "Google IT

Support" From 23/01/2024 To 14/03/2024 In Department of Computer

Science , PRIST University, Thanjavur

K. Pinnalathu
Coordinator

HOD
Department of Computer Science
School of Arts and Science
Ponnaiyah Ramajayam Institute of
Science and Technology (PRIST)
Thanjavur - 613 403.

DEAN **Dean**
School of Arts & Science
Ponnaiyah Ramajayam Institute of
Science & Technology (PRIST)
Deemed to be University
Vallam, Thanjavur - 613 403.



PONNAIYAH RAMAJAYAM INSTITUTE OF
SCIENCE & TECHNOLOGY (PRIST)

Declared as DEEMED-TO-BE-UNIVERSITY
U/s 3 of UGC Act, 1956

CERTIFICATE

THIS IS PRESENTED TO

SHAHUL HAMEED H (2201CA10137)

for completing the Certificate / Diploma course on “Google IT

Support” From 23/01/2024 To 14/03/2024 In Department of Computer

Science , PRIST University, Thanjavur

K. Pinnalathin
Coordinator

[Signature]
HOD
Department of Computer Science
School of Arts and Science
Ponnaiyah Ramajayam Institute of
Science and Technology (PRIST)
Thanjavur - 613 403.

[Signature]
DEAN
Dean
School of Arts & Science
Ponnaiyah Ramajayam Institute of
Science & Technology (PRIST)
Deemed to be University
Velur m, Thanjavur - 613 403.



PONNAIYAH RAMAJAYAM INSTITUTE OF
SCIENCE & TECHNOLOGY (PRIST)

Declared as DEEMED-TO-BE-UNIVERSITY
U/s 3 of UGC Act, 1956

CERTIFICATE

THIS IS PRESENTED TO

KARTHICK RAJ (2201CA10138)



for completing the Certificate / Diploma course on “Google IT

Support” From 23/01/2024 To 14/03/2024 In Department of Computer

Science , PRIST University, Thanjavur

K. Pinnalathin
Coordinator

HOD
Department of Computer Science
School of Arts and Science
Ponnaiyah Ramajayam Institute of
Science and Technology (PRIST)
Thanjavur - 613 403.

DEAN Dean

School of Arts & Science
Ponnaiyah Ramajayam Institute of
Science & Technology (PRIST)
The University
Thanjavur - 613 403



**PONNAIYAH RAMAJAYAM INSTITUTE OF
SCIENCE & TECHNOLOGY (PRIST)**

Declared as DEEMED-TO-BE-UNIVERSITY
U/s 3 of UGC Act, 1956



CERTIFICATE

THIS IS PRESENTED TO

NISHA E (2201CA10201)

for completing the Certificate / Diploma course on “Google IT

Support” From 23/01/2024 To 14/03/2024 In Department of Computer

Science , PRIST University, Thanjavur

K. Prasadharan
Coordinator

HOD
Department of Computer Science
School of Arts and Science
Ponnaiyah Ramajayam Institute of
Science and Technology (PRIST)
Thanjavur - 613 403.

DEAN **Dean**
School of Arts & Science
Ponnaiyah Ramajayam Institute of
Science & Technology (PRIST)
Deemed to be University
V. V. T. Thanjavur - 613 403.





PONNAIYAH RAMAJAYAM INSTITUTE OF
SCIENCE & TECHNOLOGY (PRIST)

Declared as DEEMED-TO-BE-UNIVERSITY
U/s 3 of UGC Act, 1956

CERTIFICATE

THIS IS PRESENTED TO

DHASNEEM FIRTHOUS M R (2201CA10202)

for completing the Certificate / Diploma course on "Google IT

Support" From 23/01/2024 To 14/03/2024 In Department of Computer

Science , PRIST University, Thanjavur

K. Pinnalathin
Coordinator

HOD
Department of Computer Science
School of Arts and Science
Ponnaiyah Ramajayam Institute of
Science and Technology (PRIST)
Thanjavur - 613 403.

DEAN **Dean**
School of Arts & Science
Ponnaiyah Ramajayam Institute of
Science & Technology (PRIST)
Deemed to be University
Vellam, Thanjavur - 613 403.



PONNAIYAH RAMAJAYAM INSTITUTE OF
SCIENCE & TECHNOLOGY (PRIST)

Declared as DEEMED-TO-BE UNIVERSITY
U/s 3 of UGC Act, 1956

CERTIFICATE

THIS IS PRESENTED TO

RITHANYA S (2201CA10203)



for completing the Certificate / Diploma course on "Google IT

Support" From 23/01/2024 To 14/03/2024 In Department of Computer

Science , PRIST University, Thanjavur

K. Pinnalathin
Coordinator

HOD
Department of Computer Science
School of Arts and Science
Ponnaiyah Ramajayam Institute of
Science and Technology (PRIST)
Thanjavur - 613 403.

DEAN **Dean**
School of Arts & Science
Ponnaiyah Ramajayam Institute of
Science & Technology (PRIST)
Deemed to be University
Thanjavur - 613 403.

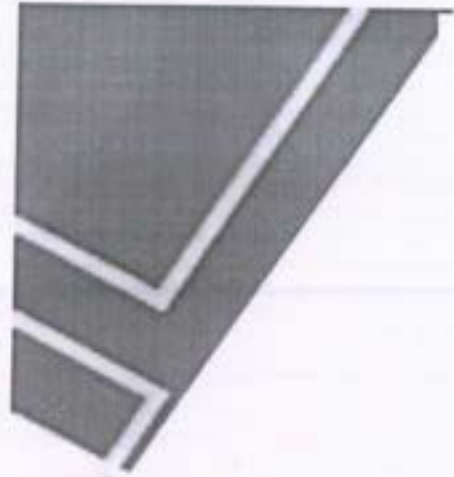

PONNAIYAH RAMAJAYAM INSTITUTE OF SCIENCE & TECHNOLOGY (PRIST)

Declared as DEEMED-TO-BE-UNIVERSITY
U/s 3 of UGC Act, 1958



CERTIFICATE

THIS IS PRESENTED TO

ASMITHA K (2201CA10204)

for completing the Certificate / Diploma course on “Google IT

Support” From 23/01/2024 To 14/03/2024 In Department of Computer

Science , PRIST University, Thanjavur

K. Pinnalathin
Coordinator

[Signature]
HOD
Department of Computer Science
Department of Arts and Science
School of Arts and Science
Ponnaiyah Ramajayam Institute of
Science and Technology (PRIST)
Thanjavur - 613 403.

[Signature]
DEAN Dean
School of Arts & Science
Ponnaiyah Ramajayam Institute of
Science & Technology (PRIST)
Deemed to be University
Vellam, Thanjavur - 613 403.



PONNAIYAH RAMAJAYAM INSTITUTE OF
SCIENCE & TECHNOLOGY (PRIST)

Declared as DEEMED-TO-BE UNIVERSITY
U/s 3 of UGC Act, 1956

CERTIFICATE

THIS IS PRESENTED TO

ABIRAMI (2201CA10205)



for completing the Certificate / Diploma course on "Google IT

Support" From 23/01/2024 To 14/03/2024 In Department of Computer

Science , PRIST University, Thanjavur

K. Pinnalathin

Coordinator

HOD

Department of Computer Science
School of Arts and Science
Ponnaiyah Ramajayam Institute of
Science and Technology (PRIST)
Thanjavur - 613 403.

Dean

DEAN

School of Arts & Science
Ponnaiyah Ramajayam Institute of
Science & Technology (PRIST)
Deemed to be University
Vallem, Thanjavur - 613 403.

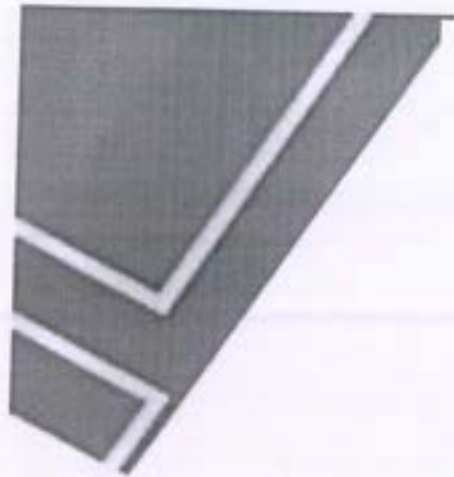

PONNAIYAH RAMAJAYAM INSTITUTE OF
SCIENCE & TECHNOLOGY (PRIST)

Declared as DEEMED-TO-BE-UNIVERSITY
U/s 3 of UGC Act, 1956



CERTIFICATE

THIS IS PRESENTED TO

JOSEPHINE ABIGAL M (2201CA10206)

for completing the Certificate / Diploma course on "Google IT

Support" From 23/01/2024 To 14/03/2024 In Department of Computer

Science , PRIST University, Thanjavur

K. Prasad Kumar
Coordinator

HOD
Department of Computer Science
School of Arts and Science
Ponnaiyah Ramajayam Institute of
Science and Technology (PRIST)
Thanjavur - 613 403.

DEAN **Dean**
School of Arts & Science
Ponnaiyah Ramajayam Institute of
Science & Technology (PRIST)
Deemed to be University
Vallam, Thanjavur - 613 403.





PONNAIYAH RAMAJAYAM INSTITUTE OF
SCIENCE & TECHNOLOGY (PRIST)

Declared as DEEMED-TO-BE-UNIVERSITY
U/s 3 of UGC Act, 1956

CERTIFICATE

THIS IS PRESENTED TO

SABRITH BEGUM A (2201CA10207)

for completing the Certificate / Diploma course on "Google IT

Support" From 23/01/2024 To 14/03/2024 In Department of Computer

Science , PRIST University, Thanjavur

K. P. Prasad
Coordinator

[Signature]
HOD
Department of Computer Science
School of Arts and Science
Ponnaiyah Ramajayam Institute of
Science and Technology (PRIST)
Thanjavur - 613 403.

[Signature]
DEAN
School of Arts & Science
Ponnaiyah Ramajayam Institute
Science & Technology
Deemed to be University
Vallam, Thanjavur - 613 403. Dean



PONNAIYAH RAMAJAYAM INSTITUTE OF
SCIENCE & TECHNOLOGY (PRIST)

Declared as DEEMED-TO-BE-UNIVERSITY
U/s 3 of UGC Act, 1956



CERTIFICATE

THIS IS PRESENTED TO

BOOPATHI V (2201CS10117)

for completing the Certificate / Diploma course on “Software

Testing using Selenium” From 17/07/2023 To 13/09/2023 In Department

of Computer Science , PRIST University, Thanjavur

K. Prasadharan
Coordinator

[Signature]

HOD
Department of Computer Science
School of Arts and Science
Ponnaiyah Ramajayam Institute of
Science and Technology (PRIST)
Thanjavur - 613 402.

[Signature]

DEAN

School of Arts & Science
Ponnaiyah Ramajayam Institute of
Science & Technology (PRIST)
Deemed to be University
Vallu m. Thanjavur - 613 402.

[Signature]
Dean



PONNAIYAH RAMAJAYAM INSTITUTE OF
SCIENCE & TECHNOLOGY (PRIST)

Declared as DEEMED-TO-BE-UNIVERSITY
U/s 3 of UGC Act, 1956



CERTIFICATE

THIS IS PRESENTED TO

SARANRAJ D (2201CS10118)

for completing the Certificate / Diploma course on "Software

Testing using Selenium" From 17/07/2023 To 13/09/2023 In Department

of Computer Science , PRIST University, Thanjavur

K. Pinnas
Coordinator

[Signature]
HOD
Department of Computer Science
School of Arts and Science
Ponnaiyah Ramajayam Institute of
Science and Technology (PRIST)
Thanjavur - 613 403.

[Signature]
Dean

DEAN
School of Arts & Science
Ponnaiyah Ramajayam Institute of
Science & Technology (PRIST)
Deemed to be University
Thanjavur - 613 403.



**PONNAIYAH RAMAJAYAM INSTITUTE OF
SCIENCE & TECHNOLOGY (PRIST)**

Declared as DEEMED-TO-BE-UNIVERSITY
U/s 3 of UGC Act, 1956



CERTIFICATE

THIS IS PRESENTED TO

RAGUL GANDHI R (2201CS10119)

for completing the Certificate / Diploma course on "Software

Testing using Selenium" From 17/07/2023 To 13/09/2023 In Department

of Computer Science , PRIST University, Thanjavur

K. Pinnasethan
Coordinator

HOD
Department of Computer Science
School of Arts and Science
Ponnaiyah Ramajayam Institute of
Science and Technology (PRIST)
Thanjavur - 613 403.

DEAN

School of Arts & Science
Ponnaiyah Ramajayam Institute of
Science & Technology (PRIST)
Deemed to be University
Velur, Thanjavur - 613 403.

Dean

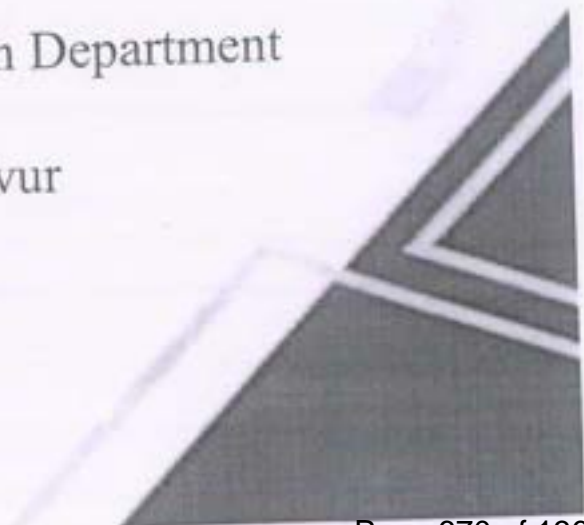

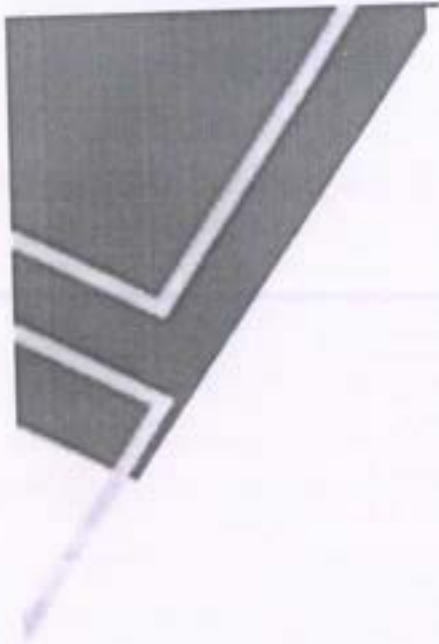

**PONNAIYAH RAMAJAYAM INSTITUTE OF
SCIENCE & TECHNOLOGY (PRIST)**

Declared as DEEMED-TO-BE-UNIVERSITY
U/s 3 of UGC Act, 1956



CERTIFICATE

THIS IS PRESENTED TO

RAJINI KUMAR M (2201CS10120)

for completing the Certificate / Diploma course on "Software

Testing using Selenium" From 17/07/2023 To 13/09/2023 In Department

of Computer Science , PRIST University, Thanjavur

K. Pinnasleban

Coordinator

Department of Computer Science
School of Arts and Science
Ponnaiyah Ramajayam Institute of
Science and Technology (PRIST)
Thanjavur - 613 403.

[Signature]

HOD

[Signature]

DEAN

Dean

School of Arts & Science
Ponnaiyah Ramajayam Institute of
Science & Technology (PRIST)
Deemed to be University
Thanjavur - 613 403.

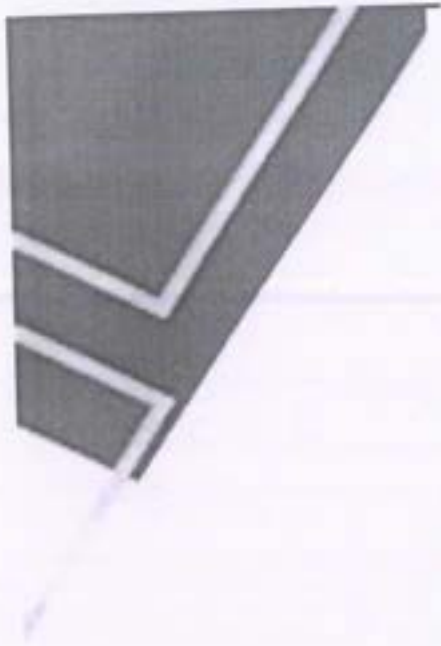

**PONNAIYAH RAMAJAYAM INSTITUTE OF
SCIENCE & TECHNOLOGY (PRIST)**

Declared as DEEMED-TO-BE-UNIVERSITY
U/s 3 of UGC Act, 1956



CERTIFICATE

THIS IS PRESENTED TO

DHINESH B (2201CS10121)

for completing the Certificate / Diploma course on "Software

Testing using Selenium" From 17/07/2023 To 13/09/2023 In Department

of Computer Science , PRIST University, Thanjavur

K. Pinnasethan
Coordinator

[Signature]
HOD
Department of Computer Science
School of Arts and Science
Ponnaiyah Ramajayam Institute of
Science and Technology (PRIST)
Thanjavur - 613 403.

[Signature]
DEAN
Dean
School of Arts & Science
Ponnaiyah Ramajayam Institute of
Science & Technology (PRIST)
Deemed to be University
Thanjavur - 613 403.

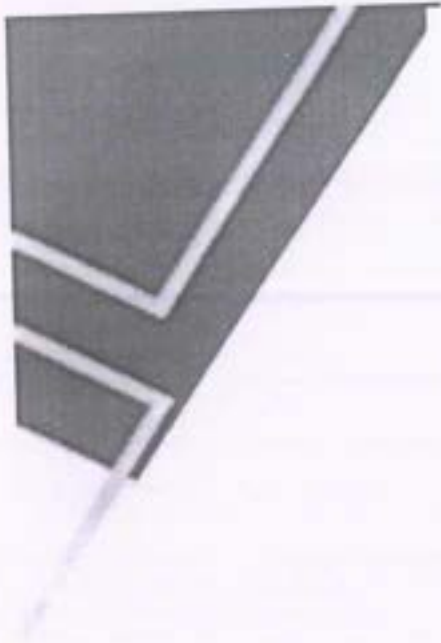

PONNAIYAH RAMAJAYAM INSTITUTE OF
SCIENCE & TECHNOLOGY (PRIST)

Declared as DEEMED-TO-BE-UNIVERSITY
U/s 3 of UGC Act, 1956



CERTIFICATE

THIS IS PRESENTED TO

HEMAVARSHAN T (2201CS10122)

for completing the Certificate / Diploma course on "Software

Testing using Selenium" From 17/07/2023 To 13/09/2023 In Department

of Computer Science , PRIST University, Thanjavur

K. Pinnasleban

Coordinator

Department of Computer Science
School of Arts and Science
Ponnaiyah Ramajayam Institute of
Science and Technology (PRIST)
Thanjavur - 613 403.

[Signature]

HOD

[Signature]

DEAN

School of Arts & Science
Ponnaiyah Ramajayam Institute of
Science & Technology (PRIST)
Deemed to be University
Thanjavur - 613 403.

Dean

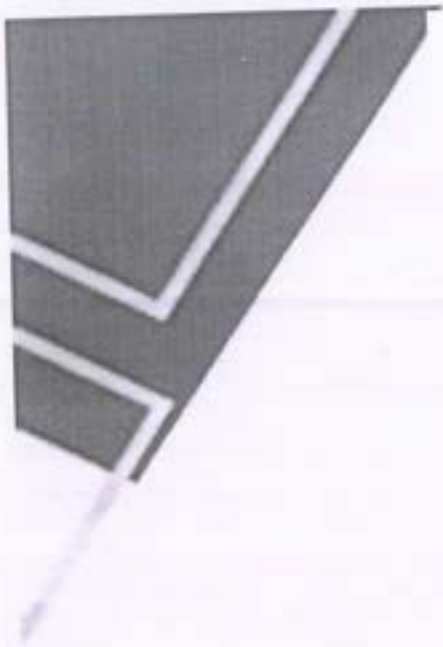

**PONNAIYAH RAMAJAYAM INSTITUTE OF
SCIENCE & TECHNOLOGY (PRIST)**

Declared as DEEMED-TO-BE-UNIVERSITY
U/s 3 of UGC Act, 1956



CERTIFICATE

THIS IS PRESENTED TO

MADHESWARAN M (2201CS10123)

for completing the Certificate / Diploma course on "Software

Testing using Selenium" From 17/07/2023 To 13/09/2023 In Department

of Computer Science , PRIST University, Thanjavur

K. Pinnalatha
Coordinator

[Signature]
HOD
Department of Computer Science
School of Arts and Science
Ponnaiyah Ramajayam Institute of
Science and Technology (PRIST)
Thanjavur - 613 403.

[Signature]
Dean

DEAN
School of Arts & Science
Ponnaiyah Ramajayam Institute of
Science & Technology (PRIST)
Deemed to be University
Vallem, Thanjavur - 613 403.

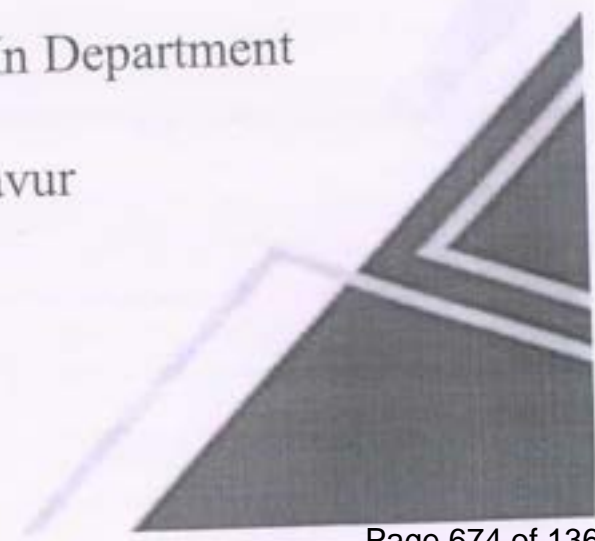



**PONNAIYAH RAMAJAYAM INSTITUTE OF
SCIENCE & TECHNOLOGY (PRIST)**

Declared as DEEMED-TO-BE-UNIVERSITY
U/s 3 of UGC Act, 1956



CERTIFICATE

THIS IS PRESENTED TO

RETHNESWARI S (2201CS10201)

for completing the Certificate / Diploma course on "Software

Testing using Selenium" From 17/07/2023 To 13/09/2023 In Department

of Computer Science , PRIST University, Thanjavur

K. Pinnaleban
Coordinator

[Signature]
HOD
Department of Computer Science
School of Arts and Science
Ponnaiyah Ramajayam Institute of
Science and Technology (PRIST)
Thanjavur - 613 403.

[Signature] *[Signature]*
Dean
School of Arts and Science
Ponnaiyah Ramajayam Institute of
Science & Technology (PRIST)
Deemed to be University
Vallam, Thanjavur - 613 403.

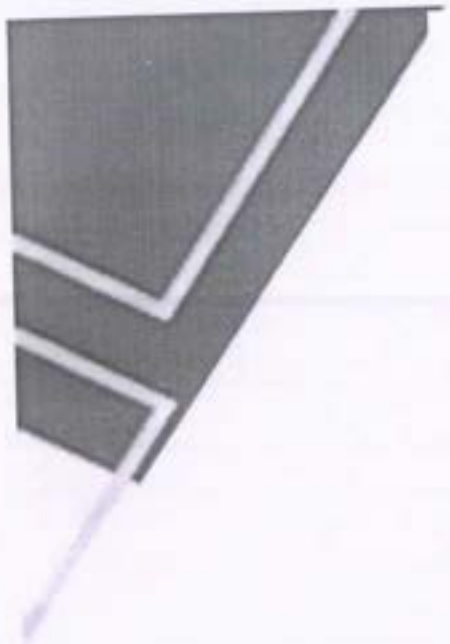

PONNAIYAH RAMAJAYAM INSTITUTE OF
SCIENCE & TECHNOLOGY (PRIST)

Declared as DEEMED-TO-BE-UNIVERSITY
U/s 3 of UGC Act, 1956



CERTIFICATE

THIS IS PRESENTED TO

GAYATHRI THIRISHA K (2201CS10202)

for completing the Certificate / Diploma course on "Software

Testing using Selenium" From 17/07/2023 To 13/09/2023 In Department

of Computer Science , PRIST University, Thanjavur

K. Pinnalathin
Coordinator

[Signature]
HOD
Department of Computer Science
School of Arts and Science
Ponnaiyah Ramajayam Institute of
Science and Technology (PRIST)
Thanjavur - 613 403.

[Signature]
Dean
DEAN
School of Arts & Science
Ponnaiyah Ramajayam Institute of
Science & Technology (PRIST)
Deemed to be University
Thanjavur - 613 403.



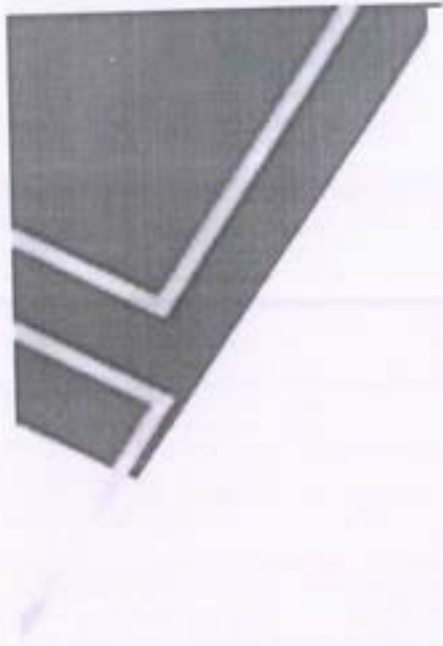

PONNAIYAH RAMAJAYAM INSTITUTE OF
SCIENCE & TECHNOLOGY (PRIST)

Declared as DEEMED-TO-BE-UNIVERSITY
U/s 3 of UGC Act, 1956



CERTIFICATE

THIS IS PRESENTED TO

BHUVANESHWARI S (2201CS10203)

for completing the Certificate / Diploma course on "Software

Testing using Selenium" From 17/07/2023 To 13/09/2023 In Department

of Computer Science , PRIST University, Thanjavur

K. Prasadharan
Coordinator

[Signature]
HOD
Department of Computer Science
School of Arts and Science
Ponnaiyah Ramajayam Institute of
Science and Technology (PRIST)
Thanjavur - 613 403.

[Signature]
DEAN
Dean
School of Arts & Science
Ponnaiyah Ramajayam Institute of
Science & Technology (PRIST)
Deemed to be University
Vallam, Thanjavur - 613 403.

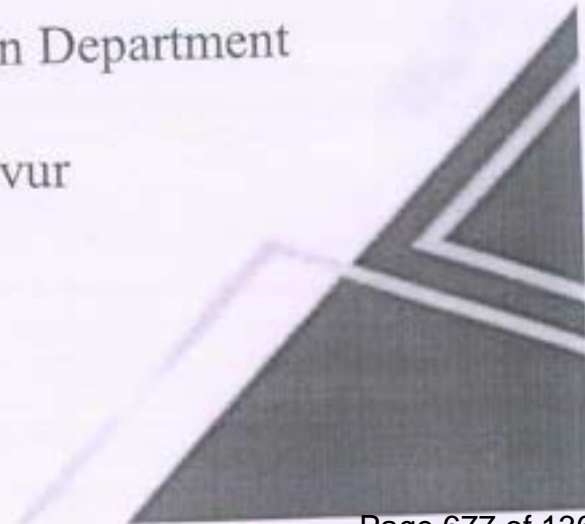



**PONNAIYAH RAMAJAYAM INSTITUTE OF
SCIENCE & TECHNOLOGY (PRIST)**

Declared as DEEMED-TO-BE-UNIVERSITY
U/s 3 of UGC Act, 1956



CERTIFICATE

THIS IS PRESENTED TO

ABIRAMI R (2201CS10204)

for completing the Certificate / Diploma course on "Software

Testing using Selenium" From 17/07/2023 To 13/09/2023 In Department

of Computer Science , PRIST University, Thanjavur

K. P. ...
Coordinator

[Signature]
HOD
Department of Computer Science
School of Arts and Science
Ponnaiyah Ramajayam Institute of
Science and Technology (PRIST)
Thanjavur - 613 403.

[Signature]

DEAN
Dean
School of Arts & Science
Ponnaiyah Ramajayam Institute of
Science & Technology (PRIST)
Deemed to be University
Thanjavur - 613 403.



**PONNAIYAH RAMAJAYAM INSTITUTE OF
SCIENCE & TECHNOLOGY (PRIST)**

Declared as DEEMED-TO-BE-UNIVERSITY
U/s 3 of UGC Act, 1956



CERTIFICATE

THIS IS PRESENTED TO

AARTHI P (2201CS10205)

for completing the Certificate / Diploma course on “Software

Testing using Selenium” From 17/07/2023 To 13/09/2023 In Department

of Computer Science , PRIST University, Thanjavur

K. Pinnalatha
Coordinator

[Signature]
HOD
Department of Computer Science
School of Arts and Science
Ponnaiyah Ramajayam Institute of
Science and Technology (PRIST)
Thanjavur - 613 403.

[Signature]
DEAN Dean
School of Arts & Science
Ponnaiyah Ramajayam Institute of
Science & Technology (PRIST)
Deemed to be University
Thanjavur - 613 403.

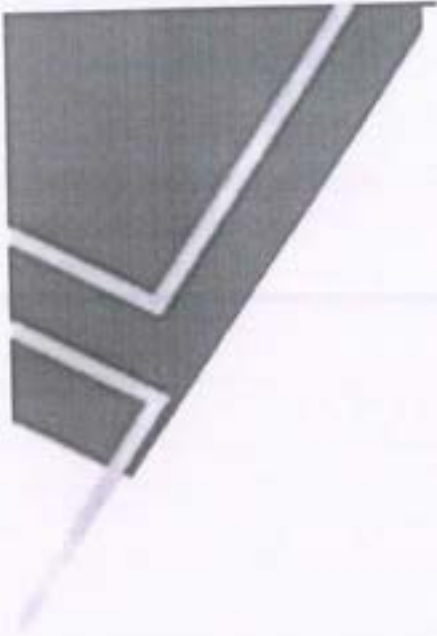

PONNAIYAH RAMAJAYAM INSTITUTE OF
SCIENCE & TECHNOLOGY (PRIST)

Declared as DEEMED-TO-BE-UNIVERSITY
U/s 3 of UGC Act, 1956



CERTIFICATE

THIS IS PRESENTED TO

BHAVANI K (2201CS10206)

for completing the Certificate / Diploma course on "Software

Testing using Selenium" From 17/07/2023 To 13/09/2023 In Department

of Computer Science , PRIST University, Thanjavur

K. P. Prasad
Coordinator

[Signature]
HOD
Department of Computer Science
School of Arts and Science
Ponnaiyah Ramajayam Institute of
Science and Technology (PRIST)
Thanjavur - 613 403.

[Signature]
DEAN
Dean
School of Arts & Science
Ponnaiyah Ramajayam Institute of
Science & Technology (PRIST)
Deemed to be University
Thanjavur - 613 403.



PONNAIYAH RAMAJAYAM INSTITUTE OF
SCIENCE & TECHNOLOGY (PRIST)

Declared as DEEMED-TO-BE-UNIVERSITY
U/s 3 of UGC Act, 1956



CERTIFICATE

THIS IS PRESENTED TO

SANDHYA S (2201CS10207)

for completing the Certificate / Diploma course on "Software

Testing using Selenium" From 17/07/2023 To 13/09/2023 In Department

of Computer Science , PRIST University, Thanjavur

K. Pinnalathu
Coordinator

[Signature]
HOD
Department of Computer Science
School of Arts and Science
Ponnaiyah Ramajayam Institute of
Science and Technology (PRIST)

[Signature]
Dean

DEAN
School of Arts & Science
Ponnaiyah Ramajayam Institute of
Science & Technology (PRIST)
Deemed to be University
Thanjavur



PONNAIYAH RAMAJAYAM INSTITUTE OF
SCIENCE & TECHNOLOGY (PRIST)

Declared as DEEMED-TO-BE-UNIVERSITY
U/s 3 of UGC Act, 1956



CERTIFICATE

THIS IS PRESENTED TO

SENGA R (2201CS10208)

for completing the Certificate / Diploma course on “Software

Testing using Selenium” From 17/07/2023 To 13/09/2023 In Department

of Computer Science , PRIST University, Thanjavur

K. Pinnalatha
Coordinator

[Signature]
HOD
Department of Computer Science
School of Arts and Science
Ponnaiyah Ramajayam Institute of
Science and Technology (PRIST)
Thanjavur - 613 403.

[Signature]
DEAN Dean
School of Arts & Science
Ponnaiyah Ramajayam Institute of
Science & Technology (PRIST)
Deemed to be University
Thanjavur - 613 403.

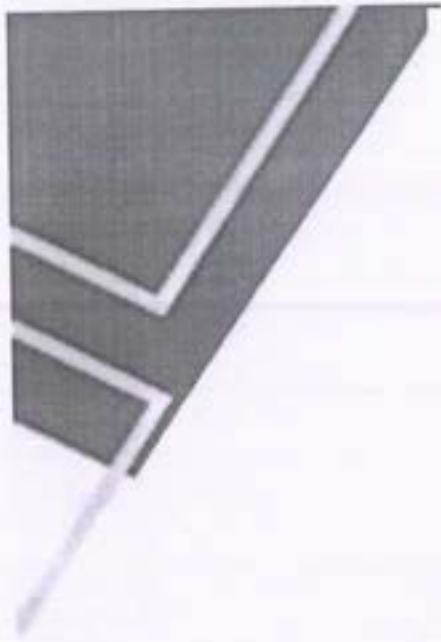

**PONNAIYAH RAMAJAYAM INSTITUTE OF
SCIENCE & TECHNOLOGY (PRIST)**

Declared as DEEMED-TO-BE-UNIVERSITY
U/s 3 of UGC Act, 1956



CERTIFICATE

THIS IS PRESENTED TO

SOUNDHARYA S (2201CS10209)

for completing the Certificate / Diploma course on “Software

Testing using Selenium” From 17/07/2023 To 13/09/2023 In Department

of Computer Science , PRIST University, Thanjavur

K. Pinnalethu
Coordinator

[Signature]
HOD
Department of Computer Science
School of Arts and Science
Ponnaiyah Ramajayam Institute of
Science and Technology (PRIST)
Thanjavur - 613 403.

[Signature]
Dean
DEAN
School of Arts & Science
Ponnaiyah Ramajayam Institute of
Science & Technology (PRIST)
Deemed to be University
Thanjavur - 613 403.



PONNAIYAH RAMAJAYAM INSTITUTE OF
SCIENCE & TECHNOLOGY (PRIST)

Declared as DEEMED-TO-BE-UNIVERSITY
U/s 3 of UGC Act, 1956



CERTIFICATE

THIS IS PRESENTED TO

SIVAGAMI M (2201CS10210)

for completing the Certificate / Diploma course on “Software

Testing using Selenium” From 17/07/2023 To 13/09/2023 In Department

of Computer Science , PRIST University, Thanjavur

K. Pinnalatha
Coordinator

[Signature]
HOD
Department of Computer Science
School of Arts and Science
Ponnaiyah Ramajayam Institute of
Science and Technology (PRIST)
Thanjavur - 613 403.

[Signature]
Dean
DEAN
School of Arts & Science
Ponnaiyah Ramajayam Institute of
Science & Technology (PRIST)
Deemed to be University
Thanjavur - 613 403.



PONNAIYAH RAMAJAYAM INSTITUTE OF
SCIENCE & TECHNOLOGY (PRIST)

Declared as DEEMED-TO-BE-UNIVERSITY
U/s 3 of UGC Act, 1956



CERTIFICATE

THIS IS PRESENTED TO

ELAKKIYA S (2201CS10211)

for completing the Certificate / Diploma course on "Software

Testing using Selenium" From 17/07/2023 To 13/09/2023 In Department

of Computer Science , PRIST University, Thanjavur

K. Pinnalatha
Coordinator

[Signature]
Department of Computer Science
School of Arts and Science
Ponnaiyah Ramajayam Institute of
Science and Technology (PRIST)
Thanjavur - 613 403.

[Signature]
Dean

DEAN
School of Arts & Science
Ponnaiyah Ramajayam Institute of
Science & Technology (PRIST)
Deemed to be University
Thanjavur - 613 403.



PONNAIYAH RAMAJAYAM INSTITUTE OF
SCIENCE & TECHNOLOGY (PRIST)

Declared as DEEMED-TO-BE-UNIVERSITY
U/s 3 of UGC Act, 1956



CERTIFICATE

THIS IS PRESENTED TO

SARANYA S (2201CS10212)

for completing the Certificate / Diploma course on “Software

Testing using Selenium” From 17/07/2023 To 13/09/2023 In Department

of Computer Science , PRIST University, Thanjavur

K. Pinnandharan
Coordinator

[Signature]
HOD
Department of Computer Science
School of Arts and Science
Ponnaiyah Ramajayam Institute of
Science and Technology (PRIST)
Thanjavur - 613 403.

[Signature]
DEAN Dean
School of Arts & Science
Ponnaiyah Ramajayam Institute of
Science & Technology (PRIST)
Deemed to be University
Thanjavur - 613 403.



PONNAIYAH RAMAJAYAM INSTITUTE OF
SCIENCE & TECHNOLOGY (PRIST)

Declared as DEEMED-TO-BE-UNIVERSITY
U/s 3 of UGC Act, 1956



CERTIFICATE

THIS IS PRESENTED TO

GAYATHRI M (2201CS10213)

for completing the Certificate / Diploma course on “Software

Testing using Selenium” From 17/07/2023 To 13/09/2023 In Department
of Computer Science , PRIST University, Thanjavur

K. Pinnalathar
Coordinator

[Signature]
HOD
Department of Computer Science
School of Arts and Science
Ponnaiyah Ramajayam Institute of
Science and Technology (PRIST)
Thanjavur - 613 403.

[Signature]
DEAN Dean
School of Arts & Science
Ponnaiyah Ramajayam Institute of
Science & Technology (PRIST)
Deemed to be University
Thanjavur - 613 403.



PONNAIYAH RAMAJAYAM INSTITUTE OF
SCIENCE & TECHNOLOGY (PRIST)

Declared as DEEMED-TO-BE-UNIVERSITY
U/s 3 of UGC Act, 1956



CERTIFICATE

THIS IS PRESENTED TO

NISHA R (2201CS10214)

for completing the Certificate / Diploma course on “Software

Testing using Selenium” From 17/07/2023 To 13/09/2023 In Department

of Computer Science , PRIST University, Thanjavur

K. Pinnalatha
Coordinator

[Signature]
HOD
Department of Computer Science
School of Arts and Science
Ponnaiyah Ramajayam Institute of
Science and Technology (PRIST)
Thanjavur - 613 403.

[Signature]
Dean
School of Arts & Science
Ponnaiyah Ramajayam Institute of
Science & Technology (PRIST)
Deemed to be University
Vallam, Thanjavur - 613 403.

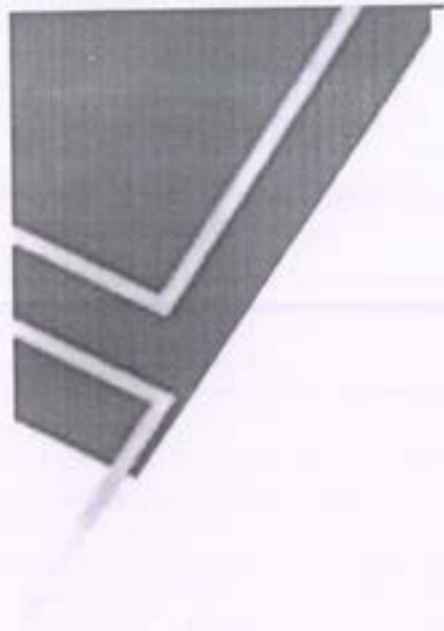

**PONNAIYAH RAMAJAYAM INSTITUTE OF
SCIENCE & TECHNOLOGY (PRIST)**

Declared as DEEMED-TO-BE-UNIVERSITY
U/s 3 of UGC Act, 1956



CERTIFICATE

THIS IS PRESENTED TO

NIVETHA M (2201CS10215)

for completing the Certificate / Diploma course on “Software

Testing using Selenium” From 17/07/2023 To 13/09/2023 In Department

of Computer Science , PRIST University, Thanjavur

K. P. ...
Coordinator

[Signature]
HOD
Department of Computer Science
School of Arts and Science
Ponnaiyah Ramajayam Institute of
Science and Technology (PRIST)
Thanjavur - 613 403.

[Signature]
DEAN Dean
School of Arts & Science
Ponnaiyah Ramajayam Institute of
Science & Technology (PRIST)
Deemed to be University
n, Thanjavur - 613 403.



PONNAIYAH RAMAJAYAM INSTITUTE OF
SCIENCE & TECHNOLOGY (PRIST)

Declared as DEEMED-TO-BE-UNIVERSITY
U/s 3 of UGC Act, 1956



CERTIFICATE

THIS IS PRESENTED TO

MAGESWARI R (2201CS10216)

for completing the Certificate / Diploma course on "Software

Testing using Selenium" From 17/07/2023 To 13/09/2023 In Department

of Computer Science , PRIST University, Thanjavur

K. Pinnalatha
Coordinator

HOD

Department of Computer Science
School of Arts and Science
Ponnaiyah Ramajayam Institute of
Science and Technology (PRIST)
Thanjavur - 613 403.

Dean

School of Arts and Science
Ponnaiyah Ramajayam Institute of
Science & Technology (PRIST)
Deemed to be University
Vallam, Thanjavur - 613 403.



**PONNAIYAH RAMAJAYAM INSTITUTE OF
SCIENCE & TECHNOLOGY (PRIST)**

Declared as DEEMED-TO-BE-UNIVERSITY
U/s 3 of UGC Act, 1956



CERTIFICATE

THIS IS PRESENTED TO

SUGASRI S (2201CS10217)

for completing the Certificate / Diploma course on “Software

Testing using Selenium” From 17/07/2023 To 13/09/2023 In Department

of Computer Science , PRIST University, Thanjavur

K. Pinnaslethu
Coordinator

[Signature]
HOD
Department of Computer Science
School of Arts and Science
Ponnaiyah Ramajayam Institute of
Science and Technology (PRIST)
Thanjavur - 613 403.

[Signature]
Dean
School of Arts & Science
Ponnaiyah Ramajayam Institute
of Science & Technology (PRIST)
Deemed to be University
Valiam, Thanjavur - 613 403.



PONNAIYAH RAMAJAYAM INSTITUTE OF
SCIENCE & TECHNOLOGY (PRIST)

Declared as DEEMED-TO-BE-UNIVERSITY
U/s 3 of UGC Act, 1956



CERTIFICATE

THIS IS PRESENTED TO

GAYATHRI K (2201CS10218)

for completing the Certificate / Diploma course on “Software

Testing using Selenium” From 17/07/2023 To 13/09/2023 In Department

of Computer Science , PRIST University, Thanjavur

K. Pinnalathar
Coordinator

[Signature]
HOD
Department of Computer Science
School of Arts and Science
Ponnaiyah Ramajayam Institute of
Science and Technology (PRIST)
Thanjavur - 613 403.

[Signature]
DEAN
Dean
School of Arts & Science
Ponnaiyah Ramajayam Institute of
Science & Technology (PRIST)
Deemed to be University
Vallam, Thanjavur - 613 403.



**PONNAIYAH RAMAJAYAM INSTITUTE OF
SCIENCE & TECHNOLOGY (PRIST)**

Declared as DEEMED-TO-BE-UNIVERSITY
U/s 3 of UGC Act, 1956



CERTIFICATE

THIS IS PRESENTED TO

DIVYA S (2201CS10219)

for completing the Certificate / Diploma course on “Software

Testing using Selenium” From 17/07/2023 To 13/09/2023 In Department

of Computer Science , PRIST University, Thanjavur

K. Prasad
Coordinator

[Signature]
HOD
Department of Computer Science
School of Arts and Science
Ponnaiyah Ramajayam Institute of
Science and Technology (PRIST)
Thanjavur - 613 403.

[Signature]
DEAN Dean
School of Arts & Science
Ponnaiyah Ramajayam Institute of
Science & Technology (PRIST)
Deemed to be University
Vellam, Thanjavur - 613 403.



PONNAIYAH RAMAJAYAM INSTITUTE OF
SCIENCE & TECHNOLOGY (PRIST)

Declared as DEEMED-TO-BE-UNIVERSITY
U/s 3 of UGC Act, 1956



CERTIFICATE

THIS IS PRESENTED TO

NITHYA T (2201CS10220)

for completing the Certificate / Diploma course on “Software

Testing using Selenium” From 17/07/2023 To 13/09/2023 In Department

of Computer Science , PRIST University, Thanjavur

K. Pinnalathin
Coordinator

[Signature]
HOD
Department of Computer Science
School of Arts and Science
Ponnaiyah Ramajayam Institute of
Science and Technology (PRIST)
Thanjavur - 613 403.

[Signature]
DEAN
Dean
School of Arts & Science
Ponnaiyah Ramajayam Institute of
Science & Technology (PRIST)
Deemed to be University
Vallam, Thanjavur - 613 403.



PONNAIYAH RAMAJAYAM INSTITUTE OF
SCIENCE & TECHNOLOGY (PRIST)

Declared as DEEMED-TO-BE-UNIVERSITY
U/s 3 of UGC Act, 1956



CERTIFICATE

THIS IS PRESENTED TO

SATHYA P (2201CS10221)

for completing the Certificate / Diploma course on “Software

Testing using Selenium” From 17/07/2023 To 13/09/2023 In Department

of Computer Science , PRIST University, Thanjavur

K. P. Senthil Kumar
Coordinator

[Signature]
HOD
Department of Computer Science
School of Arts and Science
Ponnaiyah Ramajayam Institute of
Science and Technology (PRIST)
Thanjavur - 613 403.

[Signature]
DEAN
Dean
School of Arts & Science
Ponnaiyah Ramajayam Institute of
Science & Technology (PRIST)
Deemed to be University
Valam, Thanjavur - 613 403.



PONNAIYAH RAMAJAYAM INSTITUTE OF
SCIENCE & TECHNOLOGY (PRIST)

Declared as DEEMED-TO-BE-UNIVERSITY
U/s 3 of UGC Act, 1956



CERTIFICATE

THIS IS PRESENTED TO

NANDHINI R (2201CS10222)

for completing the Certificate / Diploma course on “Software

Testing using Selenium” From 17/07/2023 To 13/09/2023 In Department

of Computer Science , PRIST University, Thanjavur

K. Pinnaleela
Coordinator

[Signature]
HOD
Department of Computer Science
School of Arts and Science
Ponnaiyah Ramajayam Institute of
Science and Technology (PRIST)
Thanjavur - 613 403.

[Signature] *[Signature]*
DEAN
Dean
School of Arts & Science
Ponnaiyah Ramajayam Institute of
Science & Technology (PRIST)
Deemed to be University
Vallam, Thanjavur - 613 403.



**PONNAIYAH RAMAJAYAM INSTITUTE OF
SCIENCE & TECHNOLOGY (PRIST)**

Declared as DEEMED-TO-BE-UNIVERSITY
U/s 3 of UGC Act, 1956



CERTIFICATE

THIS IS PRESENTED TO

SOUNDHARYA G (2201CS10223)

for completing the Certificate / Diploma course on “Software

Testing using Selenium” From 17/07/2023 To 13/09/2023 In Department

of Computer Science , PRIST University, Thanjavur

K. Pinnandharan
Coordinator

[Signature]
HOD
Department of Computer Science
School of Arts and Science
Ponnaiyah Ramajayam Institute of
Science and Technology (PRIST)
Thanjavur - 613 403.

[Signature]
DEAN
Dean
School of Arts & Science
Ponnaiyah Ramajayam Institute
of Science & Technology (PRIST)
Deemed to be University
Vallam, Thanjavur - 613 403.



PONNAIYAH RAMAJAYAM INSTITUTE OF
SCIENCE & TECHNOLOGY (PRIST)

Declared as DEEMED-TO-BE-UNIVERSITY
U/s 3 of UGC Act, 1956



CERTIFICATE

THIS IS PRESENTED TO

THIRISHA P (2201CS10224)

for completing the Certificate / Diploma course on “Software

Testing using Selenium” From 17/07/2023 To 13/09/2023 In Department

of Computer Science , PRIST University, Thanjavur

K. P. ...
Coordinator

[Signature]
HOD

[Signature]
DEAN

Department of Computer Science
School of Arts and Science
Ponnaiyah Ramajayam Institute of
Science and Technology (PRIST)
Thanjavur - 613 403.

School of Arts & Science
Ponnaiyah Ramajayam Institute of
Science & Technology (PRIST)
Deemed to be University
Vallem, Thanjavur - 613 403.



PONNAIYAH RAMAJAYAM INSTITUTE OF
SCIENCE & TECHNOLOGY (PRIST)

Declared as DEEMED-TO-BE-UNIVERSITY
U/s 3 of UGC Act, 1956



CERTIFICATE

THIS IS PRESENTED TO

SRI PRIYA K (2201CS10225)

for completing the Certificate / Diploma course on “Software

Testing using Selenium” From 17/07/2023 To 13/09/2023 In Department

of Computer Science , PRIST University, Thanjavur

K. Praveen Kumar
Coordinator

[Signature]
HOD
Department of Computer Science,
School of Arts and Science
Ponnaiyah Ramajayam Institute of
Science and Technology (PRIST)
Thanjavur - 613 403.

[Signature]
DEAN
School of Arts & Science
Ponnaiyah Ramajayam Institute
of Science & Technology (PRIST)
Deemed to be University
Vellam, Thanjavur - 613 403.



PONNAIYAH RAMAJAYAM INSTITUTE OF
SCIENCE & TECHNOLOGY (PRIST)

Declared as DEEMED-TO-BE-UNIVERSITY
U/s 3 of UGC Act, 1956



CERTIFICATE

THIS IS PRESENTED TO

KUMARI J (2201CS10226)

for completing the Certificate / Diploma course on “Software

Testing using Selenium” From 17/07/2023 To 13/09/2023 In Department

of Computer Science , PRIST University, Thanjavur

K. Pinnalatha
Coordinator

[Signature]
HOD
Department of Computer Science,
School of Arts and Science,
Ponnaiyah Ramajayam Institute of
Science and Technology (PRIST),
Thanjavur - 613 403.

[Signature]
DEAN
School of Arts & Science,
Ponnaiyah Ramajayam Institute
of Science & Technology (PRIST),
Deemed to be University
Vallem, Thanjavur - 613 403.



PONNAIYAH RAMAJAYAM INSTITUTE OF
SCIENCE & TECHNOLOGY (PRIST)

Declared as DEEMED-TO-BE-UNIVERSITY
U/s 3 of UGC Act, 1956



CERTIFICATE

THIS IS PRESENTED TO

SRI RISHITH.R (2301CA10124)

for completing the Certificate / Diploma course on “ Web

Designing And Hosting” From 20/07/2023 To 18/12/2023 In Department

of Computer Science , PRIST University, Thanjavur

K. Pinarathan
Coordinator

HOD
Department of Computer Science
School of Arts and Science
Ponnaiyah Ramajayam Institute of
Science & Technology (PRIST)
Deemed to be University
Thanjavur - 613 403

Dean

DEAN
School of Arts & Science
Ponnaiyah Ramajayam Institute of
Science & Technology (PRIST)
Deemed to be University
Vallam, Thanjavur - 613 403.



PONNAIYAH RAMAJAYAM INSTITUTE OF
SCIENCE & TECHNOLOGY (PRIST)

Declared as DEEMED-TO-BE-UNIVERSITY
U/s 3 of UGC Act, 1956



CERTIFICATE

THIS IS PRESENTED TO

S.KABILAN (2301CA10125)

for completing the Certificate / Diploma course on “ Web

Designing And Hosting” From 20/07/2023 To 18/12/2023 In Department

of Computer Science , PRIST University, Thanjavur

K. Pinnalabai
Coordinator

HOD
Department of Computer Science
School of Arts and Science
Ponnaiyah Ramajayam Institute of
Science and Technology (PRIST)
Thanjavur - 613 403

[Handwritten Signature]
Dean

DEAN
School of Arts & Science
Ponnaiyah Ramajayam Institute of
Science & Technology (PRIST)
Deemed to be University
Thanjavur - 613 403.

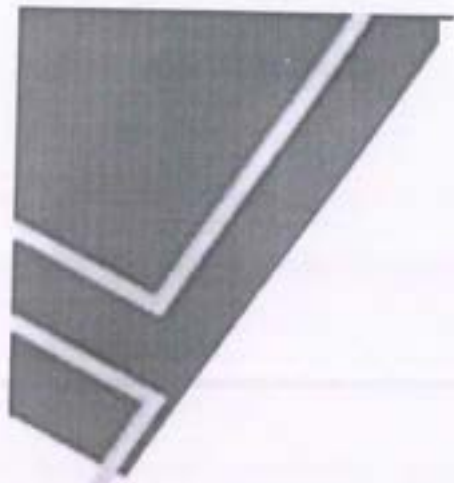

**PONNAIYAH RAMAJAYAM INSTITUTE OF
SCIENCE & TECHNOLOGY (PRIST)**

Declared as DEEMED-TO-BE-UNIVERSITY
U/s 3 of UGC Act, 1956



CERTIFICATE

THIS IS PRESENTED TO

SELVA C (2301CA10126)

for completing the Certificate / Diploma course on “ Web

Designing And Hosting” From 20/07/2023 To 18/12/2023 In Department

of Computer Science , PRIST University, Thanjavur

K. P. ...
Coordinator

HOD
Department of Computer Science
School of Arts and Science
Ponnaiyah Ramajayam Institute of
Science and Technology (PRIST)
Thanjavur - 613 403.

Se ...
Dean

DEAN
School of Arts & Science
Ponnaiyah Ramajayam Institute of
Science & Technology (PRIST)
Deemed to be University
Vallam, Thanjavur - 613 403.



PONNAIYAH RAMAJAYAM INSTITUTE OF
SCIENCE & TECHNOLOGY (PRIST)

Declared as DEEMED-TO-BE-UNIVERSITY
U/s 3 of UGC Act, 1956



CERTIFICATE

THIS IS PRESENTED TO

P M JAWAHAR MOHAN (2301CA10127)

for completing the Certificate / Diploma course on “ Web

Designing And Hosting” From 20/07/2023 To 18/12/2023 In Department

of Computer Science , PRIST University, Thanjavur

K. Prasad
Coordinator

HOD
Department of Computer Science
School of Arts and Science
Ponnaiyah Ramajayam Institute of
Science and Technology (PRIST)
Thanjavur

Debi
Dean

DEAN
School of Arts & Science
Ponnaiyah Ramajayam Institute of
Science & Technology (PRIST)
Deemed to be University
Vallam, Thanjavur - 613 403.

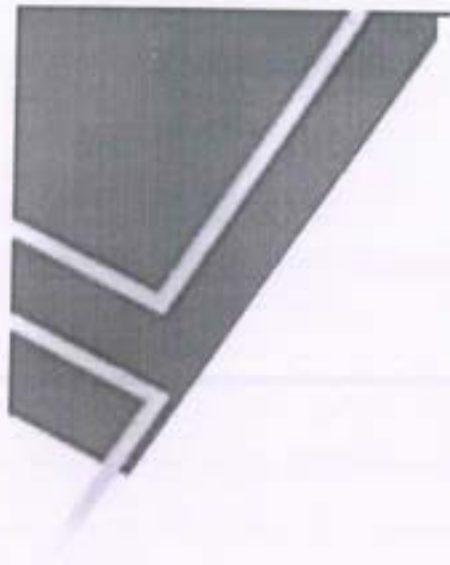

**PONNAIYAH RAMAJAYAM INSTITUTE OF
SCIENCE & TECHNOLOGY (PRIST)**

Declared as DEEMED-TO-BE-UNIVERSITY
U/s 3 of UGC Act, 1956



CERTIFICATE

THIS IS PRESENTED TO

PRASANTH R (2301CA10128)

for completing the Certificate / Diploma course on “ Web

Designing And Hosting” From 20/07/2023 To 18/12/2023 In Department

of Computer Science , PRIST University, Thanjavur

K. Pinnalatha
Coordinator

HOD
Department of Computer Science
School of Arts and Science
Ponnaiyah Ramajayam Institute of
Science and Technology (PRIST)
Thanjavur

[Handwritten Signature]
Dean

DEAN
School of Arts & Science
Ponnaiyah Ramajayam Institute of
Science & Technology (PRIST)
Deemed to be University
Vallam, Thanjavur - 613 403.



**PONNAIYAH RAMAJAYAM INSTITUTE OF
SCIENCE & TECHNOLOGY (PRIST)**

Declared as DEEMED-TO-BE-UNIVERSITY
U/s 3 of UGC Act, 1956



CERTIFICATE

THIS IS PRESENTED TO

INZAMAM ULHAQ B (2301CA10131)

for completing the Certificate / Diploma course on “ Web

Designing And Hosting” From 20/07/2023 To 18/12/2023 In Department

of Computer Science , PRIST University, Thanjavur

K. P. ...
Coordinator

HOD
Department of Computer Science
School of Arts and Science
Ponnaiyah Ramajayam Institute of
Science and Technology (PRIST)
Thanjavur - 613 403

...
Dean

DEAN
School of Arts & Science
Ponnaiyah Ramajayam Institute of
Science & Technology (PRIST)
Deemed to be University
Vallam, Thanjavur - 613 403



PONNAIYAH RAMAJAYAM INSTITUTE OF
SCIENCE & TECHNOLOGY (PRIST)

Declared as DEEMED-TO-BE-UNIVERSITY
U/s 3 of UGC Act, 1956



CERTIFICATE

THIS IS PRESENTED TO

YUVARAJ S (2301CA10132)

for completing the Certificate / Diploma course on “ Web

Designing And Hosting” From 20/07/2023 To 18/12/2023 In Department

of Computer Science , PRIST University, Thanjavur

K. P. Prasad
Coordinator

HOD

Department of Computer Science
School of Arts and Science
Ponnaiyah Ramajayam Institute of
Science and Technology (PRIST)
Thanjavur - 613 403.

[Signature]
Dean

DEAN

School of Arts & Science
Ponnaiyah Ramajayam Institute of
Science & Technology (PRIST)
Deemed to be University
Vallam, Thanjavur - 613 403



PONNAIYAH RAMAJAYAM INSTITUTE OF
SCIENCE & TECHNOLOGY (PRIST)

Declared as DEEMED-TO-BE-UNIVERSITY
U/s 3 of UGC Act, 1956



CERTIFICATE

THIS IS PRESENTED TO

VENKADESH M (2301CA10133)

for completing the Certificate / Diploma course on “ Web

Designing And Hosting” From 20/07/2023 To 18/12/2023 In Department

of Computer Science , PRIST University, Thanjavur

K. Pinnalatha
Coordinator

HOD
Department of Computer Science
School of Arts and Science
Ponnaiyah Ramajayam Institute of
Science and Technology (PRIST)
Thanjavur - 613 403.

Debin
Dean

DEAN
School of Arts & Science
Ponnaiyah Ramajayam Institute of
Science & Technology (PRIST)
Deemed to be University
Vallam, Thanjavur - 613 403.



PONNAIYAH RAMAJAYAM INSTITUTE OF
SCIENCE & TECHNOLOGY (PRIST)

Declared as DEEMED-TO-BE-UNIVERSITY
U/s 3 of UGC Act, 1956



CERTIFICATE

THIS IS PRESENTED TO

VIJAY I (2301CA10134)

for completing the Certificate / Diploma course on “ Web

Designing And Hosting” From 20/07/2023 To 18/12/2023 In Department

of Computer Science , PRIST University, Thanjavur

K. Pinnalethu
Coordinator

HOD
Department of Computer Science
School of Arts and Science
Ponnaiyah Ramajayam Institute of
Science and Technology (PRIST)
Thanjavur - 613 403

Debin
Dean

DEAN
School of Arts & Science
Ponnaiyah Ramajayam Institute of
Science & Technology (PRIST)
Deemed to be University
Vallam, Thanjavur - 613 403.



PONNAIYAH RAMAJAYAM INSTITUTE OF
SCIENCE & TECHNOLOGY (PRIST)

Declared as DEEMED-TO-BE-UNIVERSITY
U/s 3 of UGC Act, 1956



CERTIFICATE

THIS IS PRESENTED TO

PRAVEEN KUMAR I (2301CA10135)

for completing the Certificate / Diploma course on “ Web

Designing And Hosting” From 20/07/2023 To 18/12/2023 In Department

of Computer Science , PRIST University, Thanjavur

K. P. Prasad
Coordinator

HOD
Department of Computer Science
School of Arts and Science
Ponnaiyah Ramajayam Institute of
Science and Technology (PRIST)
Thanjavur - 613 403.

D. J. Jeyaraj
Dean

School of Arts & Science
Ponnaiyah Ramajayam Institute of
Science & Technology (PRIST)
Deemed to be University
Vallam, Thanjavur - 613 403.



**PONNAIYAH RAMAJAYAM INSTITUTE OF
SCIENCE & TECHNOLOGY (PRIST)**

Declared as DEEMED-TO-BE-UNIVERSITY
U/s 3 of UGC Act, 1956



CERTIFICATE

THIS IS PRESENTED TO

PRAKATHISH R (2301CA10137)

for completing the Certificate / Diploma course on “ Web

Designing And Hosting” From 20/07/2023 To 18/12/2023 In Department

of Computer Science , PRIST University, Thanjavur

K. Pinnalethu
Coordinator

HOD

Department of Computer Science
School of Arts and Science
Ponnaiyah Ramajayam Institute of
Science and Technology (PRIST)
Thanjavur - 613 403.

[Handwritten signature]
Dean

DEAN

School of Arts & Science
Ponnaiyah Ramajayam Institute of
Science & Technology (PRIST)
Deemed to be University
Vallam, Thanjavur - 613 403.



**PONNAIYAH RAMAJAYAM INSTITUTE OF
SCIENCE & TECHNOLOGY (PRIST)**

Declared as DEEMED-TO-BE-UNIVERSITY
U/s 3 of UGC Act, 1956



CERTIFICATE

THIS IS PRESENTED TO

IYYAPPAN M (2301CA10138)

for completing the Certificate / Diploma course on “ Web

Designing And Hosting” From 20/07/2023 To 18/12/2023 In Department

of Computer Science , PRIST University, Thanjavur

K. Pinnalibus
Coordinator

HOD
Department of Computer Science
School of Arts and Science
Ponnaiyah Ramajayam Institute of
Science and Technology (PRIST)
Thanjavur - 613 403.

[Handwritten Signature]
Dean

DEAN
School of Arts & Science
Ponnaiyah Ramajayam Institute of
Science & Technology (PRIST)
Deemed to be University
Vallam, Thanjavur - 613 403.





PONNAIYAH RAMAJAYAM INSTITUTE OF
SCIENCE & TECHNOLOGY (PRIST)

Declared as DEEMED-TO-BE-UNIVERSITY
U/s 3 of UGC Act, 1956



CERTIFICATE

THIS IS PRESENTED TO

JERIN M (2301CA10139)

for completing the Certificate / Diploma course on “ Web

Designing And Hosting” From 20/07/2023 To 18/12/2023 In Department

of Computer Science , PRIST University, Thanjavur

K. Pinnalatha
Coordinator

HOD
Department of Computer Science
School of Arts and Science
Ponnaiyah Ramajayam Institute of
Science and Technology (PRIST)
Thanjavur - 613 403.

Di. King
Dean

DEAN
School of Arts & Science
Ponnaiyah Ramajayam Institute of
Science & Technology (PRIST)
Deemed to be University
Vallam, Thanjavur - 613 403.



PONNAIYAH RAMAJAYAM INSTITUTE OF
SCIENCE & TECHNOLOGY (PRIST)

Declared as DEEMED-TO-BE-UNIVERSITY
U/s 3 of UGC Act, 1956



CERTIFICATE

THIS IS PRESENTED TO

AKASH B (2301CA10141)

for completing the Certificate / Diploma course on “ Web

Designing And Hosting” From 20/07/2023 To 18/12/2023 In Department

of Computer Science , PRIST University, Thanjavur

K. Pinnalethu
Coordinator

HOD

Department of Computer Science
School of Arts and Science
Ponnaiyah Ramajayam Institute of
Science and Technology (PRIST)
Thanjavur - 613 403.

debinay

Dean

DEAN

School of Arts & Science
Ponnaiyah Ramajayam Institute of
Science & Technology (PRIST)
Deemed to be University
Vallam, Thanjavur - 613 403.



PONNAIYAH RAMAJAYAM INSTITUTE OF
SCIENCE & TECHNOLOGY (PRIST)

Declared as DEEMED-TO-BE-UNIVERSITY
U/s 3 of UGC Act, 1956



CERTIFICATE

THIS IS PRESENTED TO

JAYASIMMAN D (2301CA10107)

for completing the Certificate / Diploma course on “ R/Weka

Tool” From 20/07/2023 To 18/12/2023 In Department of Computer

Science , PRIST University, Thanjavur

K. Pinnalathin
Coordinator

HOD

Department of Computer Science
School of Arts and Science
Ponnaiyah Ramajayam Institute of
Science and Technology (PRIST)
Thanjavur - 613 403.

Diya Singh
Dean

Dean
School of Arts and Science
Ponnaiyah Ramajayam Institute of
Science & Technology (PRIST)
Deemed to be University
Vallem, Thanjavur - 613 403.



PONNAIYAH RAMAJAYAM INSTITUTE OF
SCIENCE & TECHNOLOGY (PRIST)

Declared as DEEMED-TO-BE-UNIVERSITY
U/s 3 of UGC Act, 1956



CERTIFICATE

THIS IS PRESENTED TO

SHEIK ABDUL ALIM S (2301CA10108)

for completing the Certificate / Diploma course on “ R/Weka

Tool” From 20/07/2023 To 18/12/2023 In Department of Computer

Science , PRIST University, Thanjavur

K. Pinnalethu
Coordinator

HOD
Department of Computer Science
School of Arts and Science
Ponnaiyah Ramajayam Institute of
Science and Technology (PRIST)
Thanjavur - 613 403.

DEAN
School of Arts & Science
Ponnaiyah Ramajayam Institute of
Science & Technology (PRIST)
Deemed to be University
Vallam, Thanjavur - 613 403.



PONNAIYAH RAMAJAYAM INSTITUTE OF
SCIENCE & TECHNOLOGY (PRIST)

Declared as DEEMED-TO-BE-UNIVERSITY
U/s 3 of UGC Act, 1956



CERTIFICATE

THIS IS PRESENTED TO

KANNAN K (2301CA10109)

for completing the Certificate / Diploma course on “ R/Weka

Tool” From 20/07/2023 To 18/12/2023 In Department of Computer

Science , PRIST University, Thanjavur

K. Pinnalathar
Coordinator

HOD

Department of Computer Science
School of Arts and Science
Ponnaiyah Ramajayam Institute of
Science and Technology (PRIST)
Thanjavur - 613 403.

Diya Bin
Dean

DEAN

School of Arts & Science
Ponnaiyah Ramajayam Institute of
Science & Technology (PRIST)
Deemed to be University
Vallam, Thanjavur - 613 403.



**PONNAIYAH RAMAJAYAM INSTITUTE OF
SCIENCE & TECHNOLOGY (PRIST)**

Declared as DEEMED-TO-BE-UNIVERSITY
U/s 3 of UGC Act, 1956



CERTIFICATE

THIS IS PRESENTED TO

K.KARAN (2301CA10111)

for completing the Certificate / Diploma course on “ R/Weka

Tool” From 20/07/2023 To 18/12/2023 In Department of Computer

Science , PRIST University, Thanjavur

K. P. ...
Coordinator

HOD
Department of Computer Science
School of Arts and Science
Ponnaiyah Ramajayam Institute of
Science and Technology (PRIST)
Thanjavur - 613 403.

Dean

DEAN
School of Arts & Science
Ponnaiyah Ramajayam Institute
Science & Technology (PRIST)
Deemed to be University
Vallam, Thanjavur - 613 403.

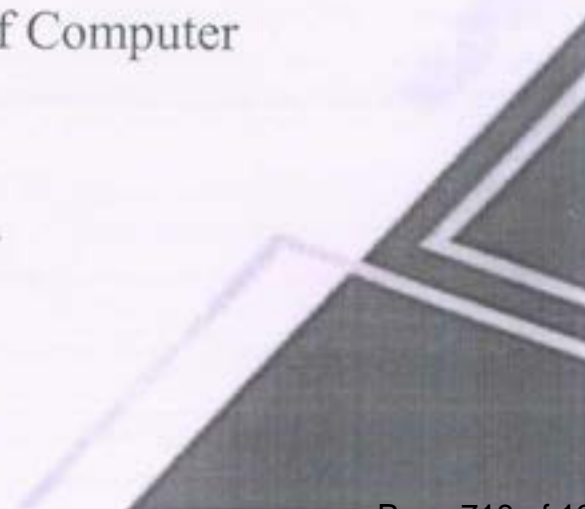



PONNAIYAH RAMAJAYAM INSTITUTE OF
SCIENCE & TECHNOLOGY (PRIST)

Declared as DEEMED-TO-BE-UNIVERSITY
U/s 3 of UGC Act, 1956



CERTIFICATE

THIS IS PRESENTED TO

AJITHKUMAR K (2301CA10112)

for completing the Certificate / Diploma course on “ R/Weka

Tool” From 20/07/2023 To 18/12/2023 In Department of Computer

Science , PRIST University, Thanjavur

K. Pinnalathin
Coordinator

HOD
Department of Computer Science
School of Arts and Science
Ponnaiyah Ramajayam Institute of
Science and Technology (PRIST)
Thanjavur - 613 403.

ling
Dean

DEAN
School of Arts & Science
Ponnaiyah Ramajayam Institute
Science & Technology (PRIST)
Deemed to be University
Vallam, Thanjavur - 613 403.



PONNAIYAH RAMAJAYAM INSTITUTE OF
SCIENCE & TECHNOLOGY (PRIST)

Declared as DEEMED-TO-BE-UNIVERSITY
U/s 3 of UGC Act, 1956



CERTIFICATE

THIS IS PRESENTED TO

DHARANIDHARAN P (2301CA10113)

for completing the Certificate / Diploma course on “ R/Weka

Tool” From 20/07/2023 To 18/12/2023 In Department of Computer

Science , PRIST University, Thanjavur

K. Pinnalaba
Coordinator

HOD
Department of Computer Science
School of Arts and Science
Ponnaiyah Ramajayam Institute of
Science and Technology (PRIST)
Thanjavur - 613 403.

king
Dean

DEAN
School of Arts & Science
Ponnaiyah Ramajayam Institute of
Science & Technology (PRIST)
Deemed to be University
Vallam, Thanjavur - 613 403.

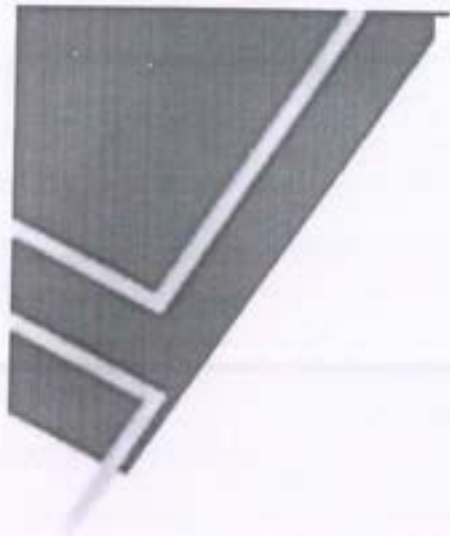

PONNAIYAH RAMAJAYAM INSTITUTE OF
SCIENCE & TECHNOLOGY (PRIST)

Declared as DEEMED-TO-BE-UNIVERSITY
U/s 3 of UGC Act, 1956



CERTIFICATE

THIS IS PRESENTED TO

GURU PANDIYAN.R (2301CA10114)

for completing the Certificate / Diploma course on “ R/Weka

Tool” From 20/07/2023 To 18/12/2023 In Department of Computer

Science , PRIST University, Thanjavur

K. Pinnalathur
Coordinator

HOD

Department of Computer Science
School of Arts and Science
Ponnaiyah Ramajayam Institute of
Science and Technology (PRIST)
Thanjavur - 613 403.

Dean

DEAN

School of Arts & Science
Ponnaiyah Ramajayam Institute of
Science & Technology (PRIST)
Deemed to be University
Vallam, Thanjavur - 613 403.





PONNAIYAH RAMAJAYAM INSTITUTE OF
SCIENCE & TECHNOLOGY (PRIST)

Declared as DEEMED-TO-BE-UNIVERSITY
U/s 3 of UGC Act, 1956



CERTIFICATE

THIS IS PRESENTED TO

GUGANESHWARAN B (2301CA10115)

for completing the Certificate / Diploma course on “ R/Weka

Tool” From 20/07/2023 To 18/12/2023 In Department of Computer

Science , PRIST University, Thanjavur

K. Pinnalethu
Coordinator

HOD
Department of Computer Science
School of Arts and Science
Ponnaiyah Ramajayam Institute of
Science and Technology (PRIST)
Thanjavur - 613 403.

Dean

DEAN
School of Arts & Science
Ponnaiyah Ramajayam Institute of
Science & Technology (PRIST)
Deemed to be University
Vallam, Thanjavur - 613 403.

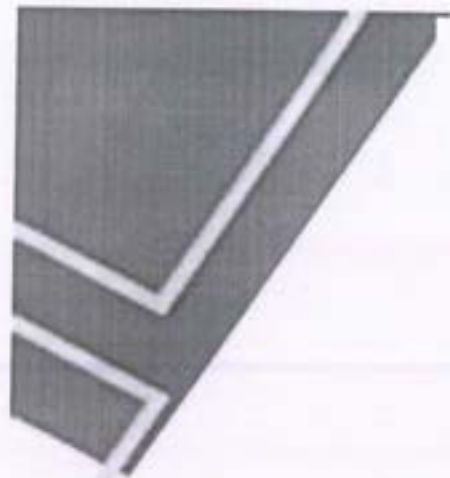

PONNAIYAH RAMAJAYAM INSTITUTE OF
SCIENCE & TECHNOLOGY (PRIST)

Declared as DEEMED-TO-BE-UNIVERSITY
U/s 3 of UGC Act, 1956



CERTIFICATE

THIS IS PRESENTED TO

RAJGANESH K (2301CA10117)

for completing the Certificate / Diploma course on “ R/Weka

Tool” From 20/07/2023 To 18/12/2023 In Department of Computer

Science , PRIST University, Thanjavur

K. Pinnalethu
Coordinator

HOD
Department of Computer Science
School of Arts and Science
Ponnaiyah Ramajayam Institute of
Science and Technology (PRIST)
Thanjavur - 613 403.

Dean

DEAN
School of Arts & Science
Ponnaiyah Ramajayam Institute of
Science & Technology (PRIST)
Deemed to be University
Vallam, Thanjavur - 613 403.





PONNAIYAH RAMAJAYAM INSTITUTE OF
SCIENCE & TECHNOLOGY (PRIST)

Declared as DEEMED-TO-BE-UNIVERSITY
U/s 3 of UGC Act, 1956



CERTIFICATE

THIS IS PRESENTED TO

SRIRAMAKRISHNAN R (2301CA10118)

for completing the Certificate / Diploma course on “ R/Weka

Tool” From 20/07/2023 To 18/12/2023 In Department of Computer

Science , PRIST University, Thanjavur

K. Pinnalathu
Coordinator

HOD

Department of Computer Sci...
School of Arts and Science
Ponnaiyah Ramajayam Institute of
Science and Technology (PRIST)
Thanjavur - 613 403.

Dean

DEAN

School of Arts & Science
Ponnaiyah Ramajayam
Science & Technology
Deemed to be Univ.
Vallam, Thanjavur - 613 403.

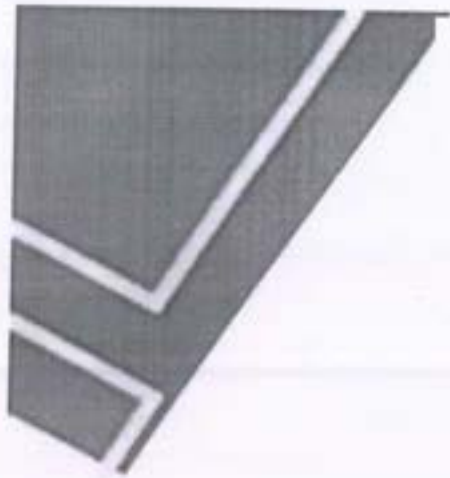

PONNAIYAH RAMAJAYAM INSTITUTE OF
SCIENCE & TECHNOLOGY (PRIST)

Declared as DEEMED-TO-BE-UNIVERSITY
U/s 3 of UGC Act, 1956



CERTIFICATE

THIS IS PRESENTED TO

AMUTHAN P (2301CA10119)

for completing the Certificate / Diploma course on “ R/Weka

Tool” From 20/07/2023 To 18/12/2023 In Department of Computer

Science , PRIST University, Thanjavur

K. Pinnalath
Coordinator

HOD
Department of Computer Science,
School of Arts and Science
Ponnaiyah Ramajayam Institute of
Science and Technology (PRIST)
Thanjavur - 613 403.

Dean

DEAN
School of Arts & Science
Ponnaiyah Ramajayam Institute of
Science & Technology (PRIST)
Deemed to be University
Vallam, Thanjavur - 613 403.





PONNAIYAH RAMAJAYAM INSTITUTE OF
SCIENCE & TECHNOLOGY (PRIST)

Declared as DEEMED-TO-BE-UNIVERSITY
U/s 3 of UGC Act, 1956



CERTIFICATE

THIS IS PRESENTED TO

SUDHAKARAN S (2301CA10120)

for completing the Certificate / Diploma course on “ R/Weka

Tool” From 20/07/2023 To 18/12/2023 In Department of Computer

Science , PRIST University, Thanjavur

K. Pinnalathas
Coordinator

HO,
Department of Computer
School of Arts and Science
Ponnaiyah Ramajayam Institute of
Science and Technology (PRIST)
Thanjavur - 613 403.

Dean

DEAN
School of Arts & Science
Ponnaiyah Ramajayam Institute of
Science & Technology (PRIST)
Deemed to be University
Vallam, Thanjavur - 613 403.

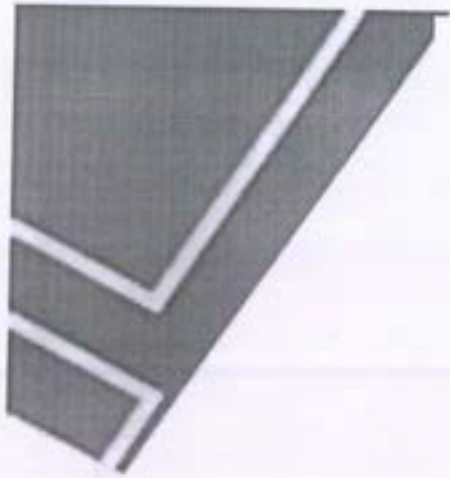

PONNAIYAH RAMAJAYAM INSTITUTE OF
SCIENCE & TECHNOLOGY (PRIST)

Declared as DEEMED-TO-BE-UNIVERSITY
U/s 3 of UGC Act, 1956



CERTIFICATE

THIS IS PRESENTED TO

H.MOHAMED AFSAR (2301CA10121)

for completing the Certificate / Diploma course on “ R/Weka

Tool” From 20/07/2023 To 18/12/2023 In Department of Computer

Science , PRIST University, Thanjavur

K. Pinnalethu
Coordinator

HOD
Department of Computer
School of Arts and Science
Ponnaiyah Ramajayam Institute of
Science and Technology (PRIST)
Thanjavur - 613 403.

Dean

DEAN
School of Arts & Science
Ponnaiyah Ramajayam Institute of
Science & Technology (PRIST)
Deemed to be University
Vallam, Thanjavur - 613 403.





PONNAIYAH RAMAJAYAM INSTITUTE OF
SCIENCE & TECHNOLOGY (PRIST)

Declared as DEEMED-TO-BE-UNIVERSITY
U/s 3 of UGC Act, 1956



CERTIFICATE

THIS IS PRESENTED TO

R.BARATH (2301CA10122)

for completing the Certificate / Diploma course on “ R/Weka

Tool” From 20/07/2023 To 18/12/2023 In Department of Computer

Science , PRIST University, Thanjavur

K. Pinnalethu
Coordinator

HOD

Department of Computer Science
School of Arts and Science
Ponnaiyah Ramajayam Institute of
Science and Technology (PRIST)
Thanjavur - 613 403.

DEAN

School of Arts & Science
Ponnaiyah Ramajayam Institute of
Science & Technology (PRIST)
Deemed to be University
Vallam, Thanjavur - 613 403.

Dean



PONNAIYAH RAMAJAYAM INSTITUTE OF
SCIENCE & TECHNOLOGY (PRIST)

Declared as DEEMED-TO-BE-UNIVERSITY
U/s 3 of UGC Act, 1956



CERTIFICATE

THIS IS PRESENTED TO

PRAKASH.R (2301CA10123)

for completing the Certificate / Diploma course on “ R/Weka

Tool” From 20/07/2023 To 18/12/2023 In Department of Computer

Science , PRIST University, Thanjavur

K. Pinnalatha
Coordinator

[Signature]
H.L.
Department of Computer
School of Arts and Science
Ponnaiyah Ramajayam Institute of
Science and Technology (PRIST)
Thanjavur - 613 403.

[Signature]
Dean

DEAN
School of Arts & Science
Ponnaiyah Ramajayam Institute
Science & Technology (PRIST)
Deemed to be University
Vallam, Thanjavur - 613 403.





PONNAIYAH RAMAJAYAM INSTITUTE OF
SCIENCE & TECHNOLOGY (PRIST)
Deemed as DEEMED TO BE UNIVERSITY
Uts. 2 of UGC Act, 1956

SCHOOL OF ARTS AND SCIENCE

DEPARTMENT OF ENGLISH

2023 – 2024

Diploma course

In

Radio Jockey

Department of English

HOB

Ponnaiyah

Ponnaiyah Ramajayam Institute of
Science & Technology (PRIST)
Deemed to be University
Vallur, Thanjavur - 613 403

Eligibility: Students studying

Any degree programme

Course duration: 1 year

Examination: Practical exam

Duration: 3 hrs

Award of Certificate:

*Certificates will be awarded after passing
the practical exam*

Dean

School of Arts & Science
Ponnaiyah Ramajayam Institute of
Science & Technology (PRIST)
Deemed to be University
Vallur, Thanjavur - 613 403

ABOUT THE UNIVERSITY

PRIST University, Ponnaiyah Ramajayam Institutions, made a foray into the Academic Domain, with the establishment of Sri Ram Institute of Computer Science and Technology in 1985. Over time, various institutions of higher learning such as Arts and Science College, College of Engineering and Technology, College of Education, Research Institution, Polytechnic College are added feathers to the PRIST crown. Today, PRIST commands a massive student base, spread across a whole array of campuses such as Pudukcherry, Tirchi, Kumbakonam, Chennai and Madurai. The Academic research extends right from school education up to the level of the Ph.D Doctoral programmes in a rich array of disciplines such as Medicine, Engineering, Arts & Science, education, Pharmacy, Management, and Technology etc.

ABOUT THE DEPARTMENT

The Department of English under Ponnaiyah Ramajayam Institute of Science and Technology (PRIST) was established at Valliam, Thanjavur in the year 2008. The Department of English runs B.A, M.A., M.Phil., and Ph.D degree in English. It imparts English language skills to the rural students. The Department brings out the hidden talents of the students. Students are encouraged to pursue their higher studies and research works.

DIPLOMA IN RADIO JOCKEY

Objectives

Make Confident, Creative and personality ability to do multi-tasking by handling public relations

To Roles ranged from supervising producers and appeared on a number of TV shows for making

people aware of career choices as a Radio Jockey

Outcome
To enhance correct breathing techniques, pronunciation, modulation, projection etc.

To Enrich correct body language and flow of language

Unit-I- Effectively make airlines, weather and railway announcements

Unit-II- Effectively write/present interesting Radio Scripts & how to read the news on Radio & TV

Unit-III- How to get over the fear of public speaking & "Professional Presentation" correct body language

Unit-IV- Narration, cartoon and lip sync dubbing (Theory only)

Unit-V- E-Book Narration- How to narrate & explore the upcoming E- book market boom

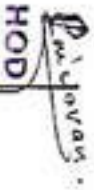
P. S. GOVAN

HOD

Department of English

Ponnaiyah Ramajayam Institute of
Science & Technology (PRIST)

Deemed to be University
Valliam, Thanjavur - 613 403

Dean

School of Arts & Science

Ponnaiyah Ramajayam Institute of
Science & Technology (PRIST)

Deemed to be University
Valliam, Thanjavur - 613 403





**PONNAIYAH RAMAJAYAM INSTITUTE OF
SCIENCE & TECHNOLOGY (PRIST)**

Declared as OCEMED TO BE UNIVERSITY
Uis 3 of UGC Act, 1956

SCHOOL OF ARTS AND SCIENCE

DEPARTMENT OF ENGLISH

2023 – 2024

CERTIFICATE E COURSE

PERSONAL BRANDING FOR CAREER ENHANCEMENT

P. S. S. S.

HOD

Department of English
Ponnaiyah Ramajayam Institute of
Science & Technology (PRIST)
Deemed to be University
Vallam, Tirunelveli - 627 002

Eligibility: Students studying

Any programme

Course duration: 6 months

Examination: Practical exam

Duration: 3 hrs

Award of Certificate:

**Certificates will be awarded after
passing the practical exam**

[Signature]

Dean

School of Arts & Science
Ponnaiyah Ramajayam Institute of
Science & Technology (PRIST)
Deemed to be University
Vallam, Tirunelveli - 627 002

UT THE UNIVERSITY

PRIST University, Ponnaiyah Ramajayam Institutions, made a foray into the Academic Domain, with the establishment of Sri Ram Institute of Computer Science and Technology in 1985. Over time, various institutions of higher learning such as Arts and Science College, College of Engineering and Technology, College of Education, Research Institution, Polytechnic College are added feathers to the PRIST crown. Today, PRIST commands a massive student base, spread across a whole array of campuses such as Chuchery, Trichy, Kumbakonam, Chennai and Madurai. The Academic research extends it from school education up to the level of the Ph.D Doctoral programmes in a rich variety of disciplines such as Medicine, Engineering, Arts & Science, education, Pharmacy, Management, and Technology etc.

ABOUT THE DEPARTMENT

The Department of English under Ponnaiyah Ramajayam Institute Science and Technology (PRIST) was established at Vallam, Thanjavur the year 2008. The Department of English runs B.A, M.A., M.Phil., and D degree in English. It imparts English language skills to the rural talents. The Department brings out the hidden talents of the students. Talents are encouraged to pursue their higher studies and research works.

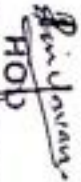
HOB

Department of English
Ponnaiyah Ramajayam Institute of
Science & Technology (PRIST)
Deemed to be University
Vallam, Thanjavur - 613 403

CERTIFICATE COURSE ON

PERSONAL BRANDING FOR CAREER ENHANCEMENT

Objectives

Personal Branding for Career Enhancement includes the essentials of personal branding, Self-awareness, communication, and leveraging personal brand strategies for career advancement.

Outcome

This syllabus introduces key concepts of personal branding and provides practical tools for developing and leveraging a personal brand for career success. Each unit builds on the previous one, offering students a step-by-step guide to crafting a brand that aligns with their professional goals.

Unit- I-What is Personal Branding

Why personal branding matters in the professional world

Key Elements of Personal Branding

The Psychology of Personal Branding

Introduction to Career Enhancement

Unit II -Discovering Your Personal Strengths, Defining Your Unique Value Proposition (UVP), Building Confidence and Presence-Visual Identity

UNIT- III

The Importance of an Online Presence, Creating a LinkedIn Profile That Stands Out, Personal Website or Portfolio, Social Media Strategy

UNIT- IV - The Role of Communication in Personal Branding, Public Speaking and Presentation Skills, Networking and Relationship-Building, Managing Difficult Conversations and Feedback

UNIT-V

Aligning Your Personal Brand with Career Goals, Personal Branding for Job Search and Promotion, Becoming a Thought Leader, Measuring the Success of Your Personal Brand



Dean

School of Arts & Science
Ponnaiyah Ramajayam Institute of
Science & Technology (PRIST)
Deemed to be University
Vallam, Thanjavur - 613 403

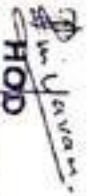

PONNAIYAH RAMALINGAM INSTITUTE OF
SCIENCE & TECHNOLOGY (PRIST)
Deemed as ODEWD to be UNIVERSITY
UO 3 of ODC Act, 1956

SCHOOL OF ARTS AND SCIENCE
DEPARTMENT OF ENGLISH
2023 - 2024
Diploma
In
ENGLISH FOR SUBTITLING

HOD

Department of English
Ponnaiyah Ramalingam Institute of
Science & Technology (PRIST)
Deemed to be University
Vallam, Thanjavur - 613 32

Eligibility: Students studying
any degree programme

Course duration: 1 year

Examination: Practical exam

Duration: 3 hrs

Award of Certificate:
Certificates will be awarded after passing the
practical exam



Dean
School of Arts & Science
Ponnaiyah Ramalingam Institute of
Science & Technology (PRIST)
Deemed to be University
Vallam, Thanjavur - 613 403

ABOUT THE UNIVERSITY

PRIST University, Ponnaiyah Ramajayam Institutions, made a foray into the Academic Domain, with the establishment of Sri Ram Institute of Computer Science and Technology in 1985. Over time, various institutions of higher learning such as Arts and Science College, College of Engineering and Technology, College of Education, Research Institution, Polytechnic College are added feathers to the PRIST crown. Today, PRIST commands a massive student base, spread across a whole array of campuses such as Pudukhery, Trichy, Kumbakonam, Chennai and Madurai. The Academic research extends right from school education up to the level of the Ph.D Doctoral programmes in a rich array of disciplines such as Medicine, Engineering, Arts & Science, education, Pharmacy, Management, and Technology etc.

ABOUT THE DEPARTMENT

The Department of English under Ponnaiyah Ramajayam Institute of Science and Technology (PRIST) was established at Vallam, Thanjavur in the year 2008. The Department of English runs B.A., M.A., M.Phil. and PhD degree in English. It imparts English language skills to the rural students. The Department brings out the hidden talents of the students. Students are encouraged to pursue their higher studies and research works.

S. Indu Lakshmi
HOD

Department of English
Ponnaiyah Ramajayam Institute of
Science & Technology (PRIST)
Deemed to be University
Vallam, Thanjavur - 613 403

DIPLOMA IN ENGLISH FOR SUBTITLING

Objectives:

Understand the basics of subtitling, its purpose, and the fundamental skills required to create subtitles. Learn the technical skills necessary to time and synchronize subtitles effectively with Video content.

Course Outcome:

This syllabus provides a comprehensive introduction to subtitling in English, from the basic concepts and technical aspects to the creative challenges of translating and adapting content for global audiences. Each unit builds on the previous one, offering students hands-on experience in the process of creating, timing, and editing subtitles for different media types.

Course Content:

Unit I: Definition and history of subtitling
Different types of subtitles (closed captions, soft subtitles, and burned-in subtitles)

Unit II:
The role of subtitles in global media

Unit III: The Importance of Clarity and Brevity in Subtitling, Grammatical Considerations, Subtitling for Different Genres, Addressing Multilingual Content

Unit IV: Basic Timing Rules, Subtitle Duration, Subtitle Formatting Best Practices, Advanced Synchronization Techniques

Unit V: Subtitling Translation Techniques, Avoiding Overcrowding in Subtitles Strategies for Subtitling Complex Dialogues, Cultural Sensitivity in Subtitling

Unit VI: The Subtitling Review Process, Subtitle File Formats and Delivery, Post-Production Workflow, Ethical Considerations in Subtitling

S. Indu Lakshmi
Dean

School of Arts & Science
Ponnaiyah Ramajayam Institute of
Science & Technology (PRIST)
Deemed to be University
Vallam, Thanjavur - 613 403



PONNAIYAH RAMAJAYAM INSTITUTE OF
SCIENCE & TECHNOLOGY (PRIST)

Declared as DEEMED TO BE UNIVERSITY
Via 3 of UGC Act, 1956

SCHOOL OF ARTS AND SCIENCE

DEPARTMENT OF ENGLISH

2023 – 2024

Diploma

In

Visual Narratives

Richwan
HOD

Department of English
Ponnaiyah Ramajayam Institute of
Science & Technology
Deemed to be University
Vallam, Thanjavur - 613 401

Eligibility: Students studying

Any degree programme

Course duration: 1 year

Examination: Practical exam

Duration: 3 hrs

Award of Certificate:

Certificates will be awarded after passing the
practical exam

Shiv

Doan
School of Arts & Science
Ponnaiyah Ramajayam Institute of
Science & Technology (PRIST)
Deemed to be University
Vallam, Thanjavur - 613 401

ABOUT THE UNIVERSITY

PRIST University, Ponnaiyah Ramajayam Institutions, made a foray into the Academic Domain, with the establishment of Sri Ram Institute of Computer Science and Technology in 1985. Over time, various institutions of higher learning such as Arts and Science College, College of Engineering and Technology, College of Education, Research Institution, Polytechnic College are added feathers to the PRIST crown. Today, PRIST commands a massive student base, spread across a whole array of campuses such as Pudukkottai, Tirichy, Kumbakonam, Chennai and Madurai. The Academic research extends right from school education up to the level of the Ph.D Doctoral programmes in a rich array of disciplines such as Medicine, Engineering, Arts & Science, education, Pharmacy, Management, and Technology etc.

ABOUT THE DEPARTMENT

The Department of English under Ponnaiyah Ramajayam Institute of Science and Technology (PRIST) was established at Vallam, Thanjavur in the year 2008. The Department of English runs B.A., M.A., M.Phil., and Ph.D degree in English. It imparts English language skills to the rural students. The Department brings out the hidden talents of the students. Students are encouraged to pursue their higher studies and research works.

Department of English
Ponnaiyah Ramajayam Institute of
Science & Technology (PRIST)
Deemed to be University

Vallam, Thanjavur - 613 403

P. S. S. S. S.
HOD

DIPLOMA IN VISUAL NARRATIVES

Objectives:

Using elements of visual language effectively

Course Outcome:

Developing new uses and functions for word and image based storytelling

Course Content:

Unit I:

Visual storytelling techniques - to create dynamic imagery that conveys mood and emotion

Unit II:

Media, image making drawing instruments - critical reflection on narrative as a visual form

Unit III:

Analysis of essential drawing systems and techniques - "Glossary of Film Terminology" (Golden)

Analyze Once Upon a Time in the West as a visual narrative

Unit IV:

Compositional design and conceptualise scenes - Language of drawing, film, comics and sequential images

Unit V:

Animation - The Principles of Animation (Thomas&Johnston), Animation processes and studios, Analyze animated works as visual narratives

P. S. S. S. S.

School of Arts & Science
Ponnaiyah Ramajayam Institute of
Science & Technology (PRIST)
Deemed to be University
Vallam, Thanjavur - 613 403



PONNAIYAH RAMAJAYAM INSTITUTE OF
SCIENCE & TECHNOLOGY (PRIST)

Declared as DEEMED-TO-BE UNIVERSITY
U/S 3 of UGC Act, 1956

SCHOOL OF ARTS AND SCIENCE

DEPARTMENT OF ENGLISH

2023 – 2024

Certificate Course

In

Accent Training

P. S. Jayaraman
HOD

Department of English
Ponnaiyah Ramajayam Institute of
Science & Technology (PRIST)
Deemed to be University
Vellam, Thanjavur - 613 403

*Eligibility: Students studying
any degree*

Course duration: 6 months

*Examination: Practical exam
Duration: 3 hrs*

*Award of Certificate:
Certificates will be awarded after passing the
practical exam*

Dean

[Signature]

School of Arts & Science
Ponnaiyah Ramajayam Institute of
Science & Technology (PRIST)
Deemed to be University
Vellam, Thanjavur - 613 403

ABOUT THE UNIVERSITY

PRIST University, Ponnaiyah Ramajayam Institutions, made a foray into the Academic Domain, with the establishment of Sri Ram Institute of Computer Science and Technology in 1985. Over time, various institutions of higher learning such as Arts and Science College, College of Engineering and Technology, College of Education, Research Institution, Polytechnic College are added feathers to the PRIST crown. Today, PRIST commands a massive student base, spread across a whole array of campuses such as Pudukherry, Trichy, Kumbakonam, Chennai and Madurai. The Academic research extends right from school education up to the level of the Ph.D Doctoral programmes in a rich array of disciplines such as Medicine, Engineering, Arts & Science, education, Pharmacy, Management, and Technology etc.

ABOUT THE DEPARTMENT

The Department of English under Ponnaiyah Ramajayam Institute of Science and Technology (PRIST) was established at Vallam, Thanjavur in the year 2008. The Department of English runs B.A, M.A., M.Phil., and Ph.D degree in English. It imparts English language skills to the rural students. The Department brings out the hidden talents of the students. Students are encouraged to pursue their higher studies and research works.

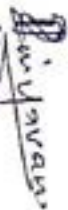
HOD

Department of English
Ponnaiyah Ramajayam Institute
of Science & Technology (PRIST)
Deemed to be University
Vallam, Thanjavur - 613 403

CERTIFICATE COURSE ON ACCENT TRAINING

Objectives:

Segmental and suprasegmental aspects of pronunciation
Phonemes and sounds in isolation

Course Outcome:

Ability to understand English spoken by native speakers
Ability to speak in a more neutral fashion
Increased career growth opportunities, Improved self-confidence

Course Content:

Unit I:
Foundations of Narrative Design

Unit II:
Visual Storytelling - Storytelling Structure: Time and Space,
Interactive Storytelling

Unit III:
Advertising, Branding, and Information Design

Unit IV:
Computers, Multimedia, and World Building

Unit V:
Neutral Accent and its types

Dean

School of Arts & Science
Ponnaiyah Ramajayam Institute of
Science & Technology (PRIST)
Deemed to be University
Vallam, Thanjavur - 613 403.



**PONNAIYAH RAMAJAYAM INSTITUTE OF
SCIENCE & TECHNOLOGY (PRIST)**

Declared as DEEMED-TO-BE-UNIVERSITY
U/s 3 of UGC Act, 1956

**DEPARTMENT OF ENGLISH
2023-2024
CERTIFICATE COURSE IN
ACCENT TRAINING
STUDENTS ATTENDANCE**

S.No	Name	Reg No	14-7-23	21-7-23	28-7-23	10-08-23	17-08-23	24-08-23	08-09-23	15-09-23	29-09-23	13-10-23	20-10-23	27-10-23	3-11-23	10-11-23	17-11-23
1	M. JAYAVANAN	2101EN10101	/	/	/	/	/	/	/	/	/	/	/	/	/	/	/
2	K.HARISH	2101EN10102	/	/	/	o	/	/	/	/	/	/	/	/	/	/	/
3	B.ASWIN RAJ	2101EN10104	/	/	/	/	/	/	/	/	/	/	/	/	/	/	/
4	M.MANIRAJAN	2101EN10105	/	/	/	/	/	/	/	/	/	/	/	/	o	/	/
5	R.EMANUEL	2101EN10106	/	/	/	/	/	/	/	/	/	/	/	/	/	/	o
6	M.AZAR	2101EN10107	/	o	/	/	/	/	/	/	/	/	/	/	/	/	/
7	F.BENJAMIN	2101EN10108	/	/	/	/	/	/	/	/	/	/	/	/	/	/	/
8	D.PRAVEENRAJ	2101EN10109	/	/	/	/	/	/	o	/	/	/	/	/	/	/	/
9	M.ARUL LAWRENCE	2101EN10110	/	/	/	o	/	/	/	/	/	/	/	/	/	/	/
10	G.PRADEEPRAJ	2101EN10111	/	/	/	/	o	/	/	/	/	/	/	/	/	/	/
11	A.AUGUSTINE	2101EN10112	/	/	/	/	/	/	/	/	/	/	/	/	/	/	o
12	D.NITHESH	2101EN10113	/	/	/	/	/	/	/	/	/	/	/	/	/	/	/
13	S.VIDHIYASAGAR	2101EN10114	/	/	/	/	/	/	/	/	/	/	/	/	/	/	/
14	K. NARAIN	2101EN10115	/	/	/	/	/	/	/	/	/	/	/	/	/	/	/
15	K.ABDULKADER	2101EN10116	/	/	/	/	/	/	/	/	/	/	/	/	/	/	/
16	J.MOHAMEDABBAS	2101EN10117	/	/	/	/	/	/	/	/	/	/	/	/	/	/	/
17	S.AGARAN	2101EN10118	/	o	/	/	/	/	/	/	/	/	/	o	/	/	/
18	G.SOORYAPRAKASH	2101EN10119	/	/	/	/	o	/	/	/	/	/	/	/	/	/	/
19	B.RANILVARMA	2101EN10120	/	/	/	/	/	/	/	/	/	/	/	/	/	o	/
20	K.SABARISH	2101EN10121	/	/	/	/	/	/	/	/	/	/	/	/	/	/	/
21	J.PRAGADEESH	2101EN10122	/	/	/	/	/	/	/	/	/	/	/	/	/	/	/
22	R.HARIHARAN	2101EN10123	/	/	o	/	/	/	o	/	/	/	/	/	/	/	/
23	J.VASANTHKUMAR	2101EN10124	/	/	/	/	/	/	/	/	/	/	/	/	/	/	/
24	A.JAMEELMOHAMED	2101EN10125	/	/	/	/	/	/	/	/	/	/	/	/	/	/	o
25	S.INBAVEL	2101EN10126	/	/	/	/	/	/	/	/	/	/	/	/	/	/	/
26	S.NANDHAKUMAR	2101EN10127	/	/	/	/	/	o	/	/	/	/	/	/	o	/	/
27	K.YOGITHRAJ	2101EN10128	/	/	/	/	/	/	/	/	o	/	/	/	/	/	/
28	D.YUVAN	2101EN10129	/	o	/	/	/	/	/	/	/	/	/	/	/	/	/
29	T.RUTHRAN	2101EN10130	/	/	/	/	/	/	/	/	/	/	/	/	/	/	o
30	S.GURUPRASATH	2101EN10131	/	/	/	/	/	/	o	/	/	/	/	/	/	/	/
31	A.SAHULAHAMED	2101EN10132	/	/	/	/	/	/	/	/	/	/	/	/	/	/	/
32	E.JUSTINRAJ	2101EN10133	/	/	/	/	/	/	/	/	/	o	/	/	/	/	/
33	D.CHRISTOPHER	2101EN10134	/	/	/	/	/	/	/	/	/	/	/	/	/	/	/

34	V.HARSHAVARTHAN	2101EN10135	/	/	/	/	/	/	/	/	/	/	/	/	/	/	/
35	L.ASHWINKUMAR	2101EN10136	/	/	/	/	/	/	a	/	/	/	/	/	/	/	/
36	N.PRANEETSINGH	2101EN10137	/	/	a	/	/	/	/	/	/	/	/	/	/	/	/
37	L.WILSON	2101EN10138	/	/	/	/	/	/	/	/	/	/	/	/	/	/	/
38	N.RAMPRASATH	2101EN10139	/	a	/	/	a	/	a	/	/	/	/	/	/	/	a
39	S.VIKRAM	2101EN10140	/	/	/	/	/	/	/	/	/	a	/	a	/	/	/
40	A.MOHAMED IRFAN	2101EN10141	/	/	/	/	/	/	/	/	/	/	/	/	/	/	/
41	D.SARAVANAN	2101EN10142	/	/	/	/	/	/	/	/	/	/	/	/	/	/	/
42	T.THAMARISELVAN	2101EN10143	/	/	a	/	/	/	a	/	/	/	/	/	/	/	/
43	G.RAHUL KANNAN	2101EN10144	/	/	/	/	a	/	/	/	/	/	/	/	/	/	/
44	A.S.DISHA	2101EN10201	/	/	/	/	/	/	/	/	/	/	/	/	/	/	/
45	A.PRIYADARSIKAA	2101EN10202	/	a	/	/	/	/	/	/	/	/	/	/	a	/	/
46	M. SAMIKSHA	2101EN10203	/	/	/	/	/	/	/	/	/	a	/	/	/	/	/
47	G.HARINI	2101EN10204	/	/	/	/	/	/	/	/	/	/	/	/	/	/	/
48	M.GOKULABHARATHI	2101EN10205	/	/	/	/	/	/	/	/	/	/	/	/	/	/	a

HOD
 Department of English
 Ponnalyah Ramajayam Institute of
 Science & Technology (PRIST)
 Deemed to be University
 Vallam, Thanjavur - 613 400

Deen
 School of Arts & Science
 Ponnalyah Ramajayam Institute of
 Science & Technology (PRIST)
 Deemed to be University
 Vallam, Thanjavur - 613 400



**PONNAIYAH RAMAJAYAM INSTITUTE OF
SCIENCE & TECHNOLOGY (PRIST)**

Declared as DEEMED-TO-BE-UNIVERSITY
U/s 3 of UGC Act, 1956

**DEPARTMENT OF ENGLISH
2023-2024
CERTIFICATE COURSE IN
PERSONAL BRANDING FOR CAREER ENHANCEMENT
STUDENTS ATTENDANCE**

S.No	Name	Reg No	14-7-23	21-7-23	28-7-23	10-08-23	17-08-23	24-08-23	08-09-23	15-09-23	29-09-23	13-10-23	20-10-23	27-10-23	3-11-23	10-11-23	17-11-23
1	Mathan Kumar V	2202EN10101	/	/	/	/	/	/	/	/	/	/	/	/	/	/	/
2	Abdul Rahman S	2202EN10102	/	/	/	/	/	/	/	/	/	/	/	/	/	/	/
3	Aswin Raj S	2202EN10103	/	/	/	/	a	/	/	/	/	/	/	/	/	/	/
4	Mukilan S	2202EN10104	/	/	/	/	/	/	/	/	/	/	/	/	/	/	/
5	SureshKumar M	2202EN10105	/	/	/	/	/	/	/	/	/	/	a	/	/	/	/
6	Muthupandi M	2202EN10106	a	/	/	/	/	/	/	/	/	/	/	/	/	/	a
7	Chellamuthu M	2202EN10107	/	a	/	/	/	/	/	/	/	/	/	/	/	/	/
8	Ramkumar .M	2202EN10108	/	/	/	/	/	/	/	/	/	/	/	/	/	/	/
9	Sathyamoorthy .B	2202EN10109	/	/	/	/	/	/	/	/	/	/	/	/	/	/	/
10	Priyadharshini S	2202EN10201	a	/	/	/	/	/	/	/	/	/	/	/	/	/	/
11	Kaipana M	2202EN10202	/	/	/	/	/	/	/	/	/	/	/	/	/	/	/
12	Kaviya R	2202EN10203	/	/	/	/	/	/	/	/	/	/	/	/	/	/	/
13	Priyanka .M	2202EN10204	/	/	/	/	/	/	/	/	/	/	/	/	/	/	/
14	Anbarasi .R	2202EN10205	/	/	/	/	/	/	/	/	/	/	/	/	/	/	/
15	Viniciya .A	2202EN10206	/	/	/	/	/	/	/	/	/	/	/	/	/	/	/
16	Ezhilarasi .T	2202EN10207	/	/	/	/	/	/	a	a	/	/	a	/	/	/	/
17	Deepika .S	2202EN10208	/	/	/	/	/	/	/	/	/	/	/	/	/	/	/
18	Dhanalakshmi .V	2202EN10209	/	/	/	/	/	/	/	/	/	a	/	/	a	/	/
19	Vijayapoorani .M	2202EN10210	/	/	/	/	/	/	/	/	/	/	/	/	/	/	/
20	Keerthana .I	2202EN10211	/	/	/	/	/	/	/	/	/	/	/	/	/	/	/

Priyavan
HOD

Department of English
Ponnaiyah Ramajayam Institute of
Science & Technology (PRIST)
Deemed to be University
Vallam, Thanjavur - 613 403

Dean

Dean
School of Arts & Science
Ponnaiyah Ramajayam Institute of
Science & Technology (PRIST)
Deemed to be University
Vallam, Thanjavur - 613 403



PONNAIYAH RAMAJAYAM INSTITUTE OF SCIENCE & TECHNOLOGY (PRIST)

Declared as DEEMED-TO-BE-UNIVERSITY
U/s 3 of UDC Act, 1956

**DEPARTMENT OF ENGLISH
2023-2024
DIPLOMA IN ENGLISH FOR SUBTITLING
STUDENTS ATTENDANCE**

S.No	Name	Reg No	14-7-23	21-7-23	28-7-23	10-08-23	17-08-23	24-08-23	08-09-23	15-09-23	29-09-23	13-10-23	20-10-23	27-10-23	3-11-23	10-11-23	17-11-23	5-12-23	19-12-23	09-01-24	16-01-24	23-01-24	30-01-24	06-02-24	13-02-24	20-02-24	27-02-24	06-03-24	13-03-24	20-03-24	27-03-24	04-04-24	11-04-24	18-04-24	25-04-24			
1	KARTHIKEYAN M	2301EN10101	/	/	/	/	/	/	/	/	/	/	/	/	/	/	/	/	/	/	/	/	/	/	/	/	/	/	/	/	/	/	/	/	/	/	/	/
2	GOWTHAM K	2301EN10102	/	/	/	/	/	/	/	/	/	/	/	/	/	/	/	/	/	/	/	/	/	/	/	/	/	/	/	/	/	/	/	/	/	/	/	/
3	MAHESHWARAN S	2301EN10103	/	/	/	/	/	/	/	/	/	/	/	/	/	/	/	/	/	/	/	/	/	/	/	/	/	/	/	/	/	/	/	/	/	/	/	/
4	KATHIRESAN A	2301EN10104	/	/	/	/	/	/	/	/	/	/	/	/	/	/	/	/	/	/	/	/	/	/	/	/	/	/	/	/	/	/	/	/	/	/	/	/
5	MANIKANDAN M	2301EN10105	/	/	/	/	/	/	/	/	/	/	/	/	/	/	/	/	/	/	/	/	/	/	/	/	/	/	/	/	/	/	/	/	/	/	/	/
6	ABINESH S	2301EN10106	/	/	/	/	/	/	/	/	/	/	/	/	/	/	/	/	/	/	/	/	/	/	/	/	/	/	/	/	/	/	/	/	/	/	/	/
7	KANAGARAJ K	2301EN10107	/	/	/	/	/	/	/	/	/	/	/	/	/	/	/	/	/	/	/	/	/	/	/	/	/	/	/	/	/	/	/	/	/	/	/	/
8	THILAK M	2301EN10109	/	/	/	/	/	/	/	/	/	/	/	/	/	/	/	/	/	/	/	/	/	/	/	/	/	/	/	/	/	/	/	/	/	/	/	/
9	MARIESWARAN M	2301EN10111	/	/	/	/	/	/	/	/	/	/	/	/	/	/	/	/	/	/	/	/	/	/	/	/	/	/	/	/	/	/	/	/	/	/	/	/
10	SARAVANAN A	2301EN10112	/	/	/	/	/	/	/	/	/	/	/	/	/	/	/	/	/	/	/	/	/	/	/	/	/	/	/	/	/	/	/	/	/	/	/	/
11	MATHI PRAKASH T	2301EN10113	/	/	/	/	/	/	/	/	/	/	/	/	/	/	/	/	/	/	/	/	/	/	/	/	/	/	/	/	/	/	/	/	/	/	/	/
12	MAHENDRAN S	2301EN10114	/	/	/	/	/	/	/	/	/	/	/	/	/	/	/	/	/	/	/	/	/	/	/	/	/	/	/	/	/	/	/	/	/	/	/	/
13	THANGAMANI E	2301EN10115	/	/	/	/	/	/	/	/	/	/	/	/	/	/	/	/	/	/	/	/	/	/	/	/	/	/	/	/	/	/	/	/	/	/	/	/
14	HARIHARAN M	2301EN10116	/	/	/	/	/	/	/	/	/	/	/	/	/	/	/	/	/	/	/	/	/	/	/	/	/	/	/	/	/	/	/	/	/	/	/	/
15	TAMILSELVAN D	2301EN10117	/	/	/	/	/	/	/	/	/	/	/	/	/	/	/	/	/	/	/	/	/	/	/	/	/	/	/	/	/	/	/	/	/	/	/	/
16	SATHEESHKUMAR T	2301EN10120	/	/	/	/	/	/	/	/	/	/	/	/	/	/	/	/	/	/	/	/	/	/	/	/	/	/	/	/	/	/	/	/	/	/	/	/
17	KATTURAJA R	2301EN10121	/	/	/	/	/	/	/	/	/	/	/	/	/	/	/	/	/	/	/	/	/	/	/	/	/	/	/	/	/	/	/	/	/	/	/	/
18	DHANUSH R	2301EN10122	/	/	/	/	/	/	/	/	/	/	/	/	/	/	/	/	/	/	/	/	/	/	/	/	/	/	/	/	/	/	/	/	/	/	/	/
19	KARTHICK G	2301EN10123	/	/	/	/	/	/	/	/	/	/	/	/	/	/	/	/	/	/	/	/	/	/	/	/	/	/	/	/	/	/	/	/	/	/	/	/
20	MANOJ KUMAR K	2301EN10124	/	/	/	/	/	/	/	/	/	/	/	/	/	/	/	/	/	/	/	/	/	/	/	/	/	/	/	/	/	/	/	/	/	/	/	/
21	PRAVEEN KUMAR R	2301EN10125	/	/	/	/	/	/	/	/	/	/	/	/	/	/	/	/	/	/	/	/	/	/	/	/	/	/	/	/	/	/	/	/	/	/	/	/
22	SIVASAKTHIVEL M	2301EN10126	/	/	/	/	/	/	/	/	/	/	/	/	/	/	/	/	/	/	/	/	/	/	/	/	/	/	/	/	/	/	/	/	/	/	/	/
23	PRABHAKARAN K	2301EN10127	/	/	/	/	/	/	/	/	/	/	/	/	/	/	/	/	/	/	/	/	/	/	/	/	/	/	/	/	/	/	/	/	/	/	/	/
24	KANAGARAJ S	2301EN10128	/	/	/	/	/	/	/	/	/	/	/	/	/	/	/	/	/	/	/	/	/	/	/	/	/	/	/	/	/	/	/	/	/	/	/	/
25	SANTHOSH B	2301EN10129	/	/	/	/	/	/	/	/	/	/	/	/	/	/	/	/	/	/	/	/	/	/	/	/	/	/	/	/	/	/	/	/	/	/	/	/
26	GURUSANKAR C	2301EN10130	/	/	/	/	/	/	/	/	/	/	/	/	/	/	/	/	/	/	/	/	/	/	/	/	/	/	/	/	/	/	/	/	/	/	/	/
27	AMARAN M	2301EN10131	/	/	/	/	/	/	/	/	/	/	/	/	/	/	/	/	/	/	/	/	/	/	/	/	/	/	/	/	/	/	/	/	/	/	/	/
28	MUNIYASAMY M	2301EN10132	/	/	/	/	/	/	/	/	/	/	/	/	/	/	/	/	/	/	/	/	/	/	/	/	/	/	/	/	/	/	/	/	/	/	/	/
29	MURALI VASANTH M	2301EN10133	/	/	/	/	/	/	/	/	/	/	/	/	/	/	/	/	/	/	/	/	/	/	/	/	/	/	/	/	/	/	/	/	/	/	/	/
30	KALAI MURUGAN P	2301EN10134	/	/	/	/	/	/	/	/	/	/	/	/	/	/	/	/	/	/	/	/	/	/	/	/	/	/	/	/	/	/	/	/	/	/	/	/
31	MUNIYASAMY K	2301EN10135	/	/	/	/	/	/	/	/	/	/	/	/	/	/	/	/	/	/	/	/	/	/	/	/	/	/	/	/	/	/	/	/	/	/	/	/
32	SARATHY K	2301EN10136	/	/	/	/	/	/	/	/	/	/	/	/	/	/	/	/	/	/	/	/	/	/	/	/	/	/	/	/	/	/	/	/	/	/	/	/
33	SIVAKUMAR M	2301EN10137	/	/	/	/	/	/	/	/	/	/	/	/	/	/	/	/	/	/	/	/	/	/	/	/	/	/	/	/	/	/	/	/	/	/	/	/
34	PRADHEEP P	2301EN10138	/	/	/	/	/	/	/	/	/	/	/	/	/	/	/	/	/	/	/	/	/	/	/	/	/	/	/	/	/	/	/	/	/	/	/	/

36	LITHISKUMAR P	2301EN10139	✓	/	/	/	/	/	/	/	/	/	/	/	/	/	/	/	/	/	/	/	/	/	/	/
	VEERA MANI R	2301EN10140	/	/	/	/	/	/	/	/	/	/	/	/	/	/	/	/	/	/	/	/	/	✓		
37	MANOJ KUMAR V	2301EN10141	/	/	/	/	/	/	/	/	/	/	/	/	/	/	/	/	/	/	/	/	/			
38	SUDHAKARAN K	2301EN10142	/	/	/	/	/	/	/	/	/	/	/	/	/	/	/	/	/	/	/	/	/			
39	AIYAPPAN R	2301EN10143	/	/	/	/	/	/	/	✓	/	/	/	/	/	/	/	/	/	/	/	/	/	✓		
40	MADHESH WARAN M	2301EN10144	/	/	/	/	/	/	/	/	/	/	/	/	/	/	/	/	/	/	/	/	/			
41	AJAYKUMAR R	2301EN10145	/	/	/	/	/	/	/	/	/	/	/	/	/	/	/	/	/	/	/	/	/			
42	SELVAMANI M	2301EN10146	✓	/	/	/	/	/	/	/	/	/	/	/	/	/	/	/	/	/	/	/	/			
43	JEGAN B	2301EN10147	/	/	/	/	/	/	/	/	✓	/	/	/	/	/	/	/	/	/	/	✓				
44	GUNASEKARAN S	2301EN10148	/	/	/	/	/	/	/	/	/	/	/	/	/	/	/	/	/	/	/	/	/			
45	MAHARAJA S	2301EN10149	/	/	/	/	/	/	/	/	/	/	/	/	/	/	/	/	/	/	/	/	/			
46	PON ARAVINDRAJA K	2301EN10150	/	/	/	/	/	/	✓	/	/	/	/	/	/	/	/	/	/	/	/	✓				
47	AJITH KUMAR M	2301EN10151	/	/	/	/	/	/	/	/	/	/	/	/	/	/	/	/	/	/	/	/	/			
48	KAMALA SUNDARI K	2301EN10201	/	/	/	/	/	/	/	/	/	/	/	/	/	/	/	/	/	/	✓					
49	VIJAYA T	2301EN10202	/	/	/	/	/	/	/	/	/	/	/	/	/	/	/	/	/	/	/	/	/			
50	PADMA SURYA S	2301EN10203	✓	/	/	/	/	/	/	/	/	/	/	/	/	/	/	/	/	/	/	✓				

Ponjayan
HOD

Department of English
Ponnalyah Ramojayam Institute of
Science & Technology (PRIST)
Deemed to be University
Vallam, Thanjavur - 613 403

[Signature]
Dean
School of Arts & Science
Ponnalyah Ramojayam Institute of
Science & Technology (PRIST)
Deemed to be University
Vallam, Thanjavur - 613 403



**PONNAIYAH RAMAJAYAM INSTITUTE OF
SCIENCE & TECHNOLOGY (PRIST)**

Declared as DEEMED-TO-BE-UNIVERSITY
U/s 3 of UGC Act, 1956

**DEPARTMENT OF ENGLISH
2023-2024
DIPLOMA IN
VISUAL NARRATIVES
STUDENTS ATTENDANCE**

S.No	Name	Reg No	14-7-23	21-7-23	28-7-23	04-08-23	11-08-23	18-08-23	25-08-23	01-09-23	08-09-23	15-09-23	22-09-23	29-09-23	06-10-23	13-10-23	20-10-23	27-10-23	03-11-23	10-11-23	17-11-23	24-11-23	01-12-23	08-12-23	15-12-23	22-12-23	29-12-23	05-01-24	12-01-24	19-01-24	26-01-24			
1	Mahendra D	2301EN20101	/	/	/	/	/	/	/	/	/	/	/	/	/	/	/	/	/	/	/	/	/	/	/	/	/	/	/	/	/	/	/	
2	Ranjith Kumar M	2301EN20102	/	/	/	/	/	/	/	/	/	/	/	/	/	/	/	/	/	/	/	/	/	/	/	/	/	/	/	/	/	/	/	
3	Muthumaharajan U	2301EN20103	/	/	/	/	/	/	/	/	/	/	/	/	/	/	/	/	/	/	/	/	/	/	/	/	/	/	/	/	/	/	/	
4	Vinobalaji K	2301EN20104	/	/	/	/	/	/	/	/	/	/	/	/	/	/	/	/	/	/	/	/	/	/	/	/	/	/	/	/	/	/	/	
5	Aravinthan M	2301EN20105	/	/	/	/	/	/	A	/	/	/	/	/	/	/	/	/	/	/	/	/	/	/	/	/	/	/	/	/	/	/	/	
6	Gowtham S	2301EN20106	/	/	/	/	/	/	/	/	/	/	/	/	/	/	/	/	/	/	/	/	/	/	/	/	/	/	/	/	/	/	/	
7	Azhagudurai A	2301EN20107	/	/	/	/	/	/	/	/	/	/	/	/	/	/	/	/	/	/	/	/	/	/	/	/	/	/	/	/	/	/	/	
8	Sathriyan I	2301EN20108	/	/	/	/	/	/	/	/	/	/	/	/	/	/	/	/	/	/	/	/	/	/	/	/	/	/	/	/	/	/	/	
9	Sathish M	2301EN20109	a	/	/	/	/	/	/	/	/	/	/	/	/	/	/	/	/	/	/	/	/	/	/	/	/	/	/	/	/	/	/	
10	Sankar D	2301EN20110	/	/	/	/	/	/	/	/	/	/	/	/	/	/	/	/	/	/	/	/	/	/	/	/	/	/	/	/	/	/	/	
11	Jawahar S	2301EN20111	/	/	/	/	/	/	/	/	/	/	/	/	/	/	/	/	/	/	/	/	/	/	/	/	/	/	/	/	/	/	/	
12	Kathiresan R	2301EN20112	/	/	/	/	/	/	/	/	/	/	/	/	/	/	/	/	/	a	/	/	/	/	/	/	/	/	/	/	/	/	/	
13	Rajajivairam M	2301EN20113	/	/	/	/	/	/	/	/	/	/	/	/	/	/	/	/	/	/	/	/	/	/	/	/	/	/	/	/	/	/	/	
14	Sathish Kumar M	2301EN20114	/	/	/	/	/	/	/	/	/	/	/	/	/	/	/	/	/	/	/	/	/	/	/	/	/	/	/	/	/	/	/	
15	Senthil Kumar P	2301EN20115	/	/	/	/	/	/	/	/	/	/	/	/	/	/	/	/	/	/	/	/	/	/	/	/	/	/	/	/	/	/	/	
16	Muruganantham T	2301EN20123	/	/	/	/	/	/	/	/	/	/	/	/	/	/	/	/	/	/	/	/	/	/	/	/	/	/	/	/	/	/	/	
17	Jagan R	2301EN20127	/	/	/	/	/	/	/	/	/	/	/	/	/	/	/	/	/	/	/	/	/	/	/	/	/	/	/	/	/	/	/	a
18	Nallasamy S	2301EN20118	/	/	/	/	/	/	/	/	/	/	/	/	/	/	/	/	/	/	/	/	/	/	/	/	/	/	/	/	/	/	/	/
19	Sudhakar M	2301EN20119	/	/	/	/	/	/	/	/	/	/	/	/	/	/	/	/	/	/	/	/	/	/	/	/	/	/	/	/	/	/	/	/
20	Thamilarasan S	2301EN20121	/	/	/	/	/	/	/	/	/	/	/	/	/	/	/	/	/	/	/	/	/	/	/	/	/	/	/	/	/	/	/	a
21	Sujitha E	2301EN20201	/	/	/	/	/	/	/	/	/	/	/	/	/	/	/	/	/	/	/	/	/	/	/	/	/	/	/	/	/	/	/	/
22	Jenifer N	2301EN20202	/	/	/	/	/	/	/	/	/	/	/	/	/	/	/	/	/	/	/	/	/	/	/	/	/	/	/	/	/	/	/	/
23	Rubha K	2301EN20203	/	/	/	/	/	/	/	/	/	/	/	/	/	/	/	/	/	/	/	/	/	/	/	/	/	/	/	/	/	/	/	/
24	Vimala D	2301EN20204	/	/	/	/	/	/	/	/	/	/	/	/	/	/	/	/	/	/	/	/	/	/	/	/	/	/	/	/	/	/	/	/

P. Rajan
HOD

Department of English
Ponnaiyah Ramajayam Institute of
Science & Technology (PRIST)
Deemed to be University
Vallam, Thanjavur - 6

Dr. J. J.

Dean
School of Arts & Science
Ponnaiyah Ramajayam Institute of
Science & Technology (PRIST)
Deemed to be University
Vallam, Thanjavur - 6



**PONNAIYAH RAMAJAYAM INSTITUTE OF
SCIENCE & TECHNOLOGY (PRIST)**

Declared as DEEMED-TO-BE-UNIVERSITY
U/s 3 of UGC Act, 1956

**DEPARTMENT OF ENGLISH
2023-2024
DIPLOMA IN RADIO JOCKEY
STUDENTS ATTENDANCE**

S. No	Name	Reg No	14-7-23	21-7-23	28-7-23	10-08-23	17-08-23	24-08-23	08-09-23	15-09-23	29-09-23	13-10-23	20-10-23	27-10-23	3-11-23	10-11-23	17-11-23	5-12-23	19-01-24	09-02-24	16-02-24	23-02-24	08-03-24	15-03-24	29-03-24	12-04-24	19-04-24	26-04-24
1	S. ANAND RAJ	2201EN10102	/	/	/	/	/	/	/	/	/	/	/	/	/	/	/	/	/	/	/	/	/	/	/	/	/	/
2	K. KARIKALVALAVAN	2201EN10103	/	/	/	/	/	/	/	/	/	/	/	/	/	/	/	/	/	/	/	/	/	/	/	/	/	/
3	N. DEENADAYALAN	2201EN10104	/	/	/	/	/	/	/	/	/	/	/	/	/	/	/	/	/	/	/	/	/	/	/	/	/	/
4	R. ELANDENRAL	2201EN10105	/	/	/	/	/	/	/	/	/	/	/	/	/	/	/	/	/	/	/	/	/	/	/	/	/	/
5	K. HEMAVARMAN	2201EN10106	/	/	/	/	/	/	/	/	/	/	/	/	/	/	/	/	/	/	/	/	/	/	/	/	/	/
6	A. MARKANDAYEN	2201EN10107	/	/	/	/	/	/	/	/	/	/	/	/	/	/	/	/	/	/	/	/	/	/	/	/	/	/
7	N. NAVEEN KUMAR	2201EN10108	/	/	/	/	/	/	/	/	/	/	/	/	/	/	/	/	/	/	/	/	/	/	/	/	/	/
8	S. MUKESH KANNAN	2201EN10109	/	/	/	/	/	/	/	/	/	/	/	/	/	/	/	/	/	/	/	/	/	/	/	/	/	/
9	M. DINESH	2201EN10110	/	/	/	/	/	/	/	/	/	/	/	/	/	/	/	/	/	/	/	/	/	/	/	/	/	/
10	T.SANTHOSH	2201EN10111	/	/	/	/	/	/	/	/	/	/	/	/	/	/	/	/	/	/	/	/	/	/	/	/	/	/
11	S.KARTHICK	2201EN10112	/	/	/	/	/	/	/	/	/	/	/	/	/	/	/	/	/	/	/	/	/	/	/	/	/	/
12	MSIVATHARUN	2201EN10113	/	/	/	/	/	/	/	/	/	/	/	/	/	/	/	/	/	/	/	/	/	/	/	/	/	/
13	VANJINATHAN .M	2201EN10114	/	/	/	/	/	/	/	/	/	/	/	/	/	/	/	/	/	/	/	/	/	/	/	/	/	/
14	ANBARASAN .D	2201EN10115	/	/	/	/	/	/	/	/	/	/	/	/	/	/	/	/	/	/	/	/	/	/	/	/	/	/
15	M.HARISHWARAN	2201EN10116	/	/	/	/	/	/	/	/	/	/	/	/	/	/	/	/	/	/	/	/	/	/	/	/	/	/
16	KARANSINGH.K	2201EN10117	/	/	/	/	/	/	/	/	/	/	/	/	/	/	/	/	/	/	/	/	/	/	/	/	/	/
17	R.JAISHANTHI	2201EN10118	/	/	/	/	/	/	/	/	/	/	/	/	/	/	/	/	/	/	/	/	/	/	/	/	/	/
18	M.SURESH	2201EN10119	/	/	/	/	/	/	/	/	/	/	/	/	/	/	/	/	/	/	/	/	/	/	/	/	/	/
19	R.V.MALAIYAN	2201EN10120	/	/	/	/	/	/	/	/	/	/	/	/	/	/	/	/	/	/	/	/	/	/	/	/	/	/
20	RAJAKUMAR .S	2201EN10121	/	/	/	/	/	/	/	/	/	/	/	/	/	/	/	/	/	/	/	/	/	/	/	/	/	/
21	RAJADURAI .S	2201EN10122	/	/	/	/	/	/	/	/	/	/	/	/	/	/	/	/	/	/	/	/	/	/	/	/	/	/
22	ANAND .R	2201EN10123	/	/	/	/	/	/	/	/	/	/	/	/	/	/	/	/	/	/	/	/	/	/	/	/	/	/
23	VENGATESHAN .A	2201EN10124	/	/	/	/	/	/	/	/	/	/	/	/	/	/	/	/	/	/	/	/	/	/	/	/	/	/
24	MURUGARAJ .S	2201EN10125	/	/	/	/	/	/	/	/	/	/	/	/	/	/	/	/	/	/	/	/	/	/	/	/	/	/
25	SURYA .A	2201EN10126	/	/	/	/	/	/	/	/	/	/	/	/	/	/	/	/	/	/	/	/	/	/	/	/	/	/
26	SILAMBARASU .C	2201EN10127	/	/	/	/	/	/	/	/	/	/	/	/	/	/	/	/	/	/	/	/	/	/	/	/	/	/
27	DANIEL RAJ .S	2201EN10128	/	/	/	/	/	/	/	/	/	/	/	/	/	/	/	/	/	/	/	/	/	/	/	/	/	/
28	ANANDHARAJ .A	2201EN10129	/	/	/	/	/	/	/	/	/	/	/	/	/	/	/	/	/	/	/	/	/	/	/	/	/	/
29	K.DEVI SRI	2201EN10201	/	/	/	/	/	/	/	/	/	/	/	/	/	/	/	/	/	/	/	/	/	/	/	/	/	/
30	S.ISHWARYA	2201EN10202	/	/	/	/	/	/	/	/	/	/	/	/	/	/	/	/	/	/	/	/	/	/	/	/	/	/
31	MAHALAKSHIMI .R	2201EN10203	/	/	/	/	/	/	/	/	/	/	/	/	/	/	/	/	/	/	/	/	/	/	/	/	/	/
32	DELFI .S	2201EN10204	/	/	/	/	/	/	/	/	/	/	/	/	/	/	/	/	/	/	/	/	/	/	/	/	/	/
33	JAYASREE .P.S	2201EN10205	/	/	/	/	/	/	/	/	/	/	/	/	/	/	/	/	/	/	/	/	/	/	/	/	/	/
34	DIVYA .E	2201EN10206	/	/	/	/	/	/	/	/	/	/	/	/	/	/	/	/	/	/	/	/	/	/	/	/	/	/

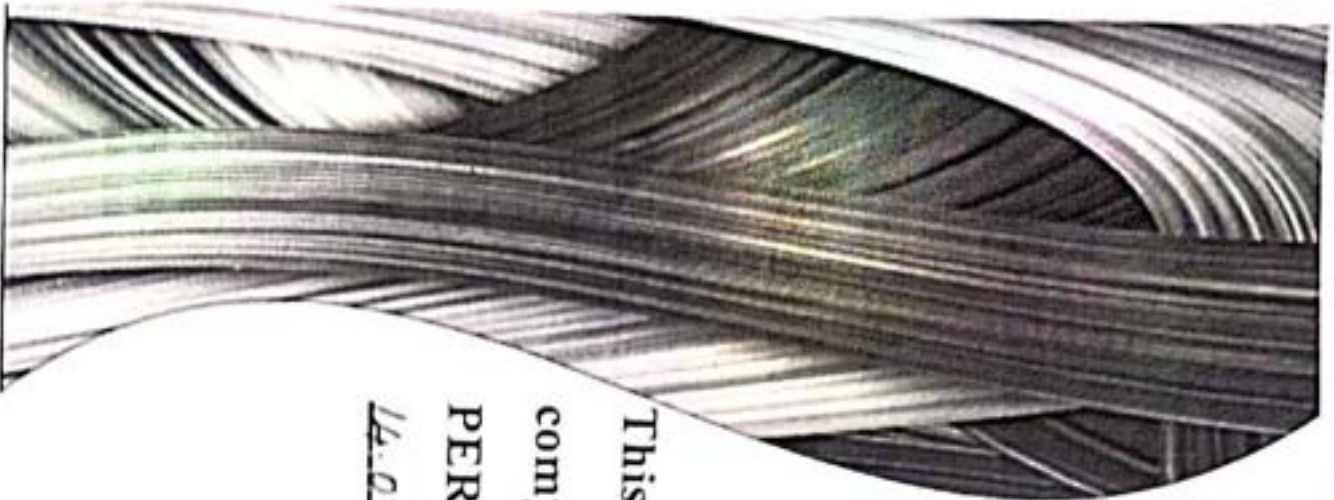

PONNAIYAH RAMAJAYAM INSTITUTE OF
SCIENCE & TECHNOLOGY (PRIST)
Declared as DEEMED TO BE UNIVERSITY
U/s 3 of UGC Act, 1956



SCHOOL OF ARTS AND SCIENCE

VALUE ADDED COURSE

Certificate of Appreciation

This is to certify that Ms/Mr Kalpna. M has
completed the Value Added Course - CERTIFICATE COURSE ON
PERSONAL BRANDING FOR CAREER ENHANCEMENT from -
14.07.2023 to 17.11.2023 during the Academic year of 2023 to 2024.

P. Sankar
Course
coordinator

P. Sankar
HOD

[Signature]
DEAN



PONNAIYAH RAMAJAYAM INSTITUTE OF
SCIENCE & TECHNOLOGY (PRIST)
Declared as DEEMED TO BE UNIVERSITY
U/S 3 of UGC Act, 1956



SCHOOL OF ARTS AND SCIENCE

VALUE ADDED COURSE

Certificate of Appreciation

This is to certify that Ms/Mr Agar. M has
completed the Value Added Course on **CERTIFICATE COURSE
ON ACCENT TRAINING** from 14.7.2023 to 17.11.2023 during
the Academic year of 2023 to 2024.

Course
coordinator

HOD

DEAN



PONNAIYAH RAMAJAYAM INSTITUTE OF
SCIENCE & TECHNOLOGY (PRIST)
Declared as DEEMED-TO-BE-UNIVERSITY
U/s 3 of UGC Act, 1956



SCHOOL OF ARTS AND SCIENCE
VALUE ADDED COURSE
Certificate of Appreciation

This is to certify that Ms/Mr Thilak.M has
completed the Value Added Course on **DIPLOMA IN ENGLISH**
FOR SUBTTLING from 14.07.2023 to 24.05.2024 during the
Academic year of 2023 to 2024.

Course
coordinator

HOD

DEAN



PONNAIYAH RAMAJAYAM INSTITUTE OF
SCIENCE & TECHNOLOGY (PRIST)
Declared as DEEMED TO BE UNIVERSITY
U/S 3 of UGC Act, 1956



SCHOOL OF ARTS AND SCIENCE

VALUE ADDED COURSE Certificate of Appreciation

This is to certify that Ms/Mr Shantham.S has
completed the Value Added Course on DIPLOMA IN VISUAL
NARRATIVES from 14.07.2023 to 24.05.2024 during the
Academic year of 2023 to 2024.

S.P. Moorthy
Course
coordinator

Prin. Jayas
HOD

[Signature]
DEAN



**PONNAIYAH RAMAJAYAM INSTITUTE OF
SCIENCE & TECHNOLOGY (PRIST)**
Declared as DEEMED-TO-BE UNIVERSITY
U/s 3 of UGC Act, 1956



SCHOOL OF ARTS AND SCIENCE
VALUE ADDED COURSE
Certificate of Appreciation

This is to certify that Ms/Mr Surya. A has
completed the Value Added Course on **DIPLOMA IN RADIO
JOCKEY** from 14.07.2023 to 24.05.2024 during the Academic
year of 2023 to 2024.

Course
coordinator

HOD

DEAN



**PONNAIYAH RAMAJAYAM INSTITUTE OF
SCIENCE & TECHNOLOGY (PRIST)**

Declared as DEEMED-TO-BE UNIVERSITY
U/a 3 of UGC Act, 1956

SCHOOL OF ARTS AND SCIENCE

DEPARTMENT OF PHYSICS

Circular

PRIST/A&S/PH/23-24/3

Date: 10.07.2023

This is to inform all physics students that the value added courses classes for academic year 2023-24 odd semester will be commenced from 17.07.2023. Hence requesting all registered students to attend the classes without fail.

1. Diploma course on crystal growth analysis
2. Certificate course on industry linked optical fiber technology
3. Certificate course on installation and maintenance of digital circuits
4. Certificate course on regulated power supply
5. Certificate course on cosmology and structure formation

The Head, Department of Physics,
PRIST Deemed to be University,
Vallam Thaniavur-613403.

DEAN

1. Hon'ble Vice Chancellor (for your kind information)
2. Registrar
3. Registrar office
4. Dean
5. Department file

DEAN
School of Arts & Science
Ponnaiyah Ramajayam Institute of
Science & Technology (PRIST)
Deemed to be University
Thaniavur - 613 403.



PONNAIYAH RAMAJAYAM INSTITUTE OF
SCIENCE & TECHNOLOGY (PRIST)

Deemed to be University
UO 3 of UGC Act, 1956

Value Added Course

Crystal Growth Analysis



Organized by

Department of Physics

School of Arts and Science

**PONNAIYA RAMAJAYAM INSTITUTE OF
SCIENCE & TECHNOLOGY**

Thanjavur 613 403

DE. Tamil Nadu

School of Arts & Science

Ponnaiyah Ramajayam Institute of

Science & Technology (PRIST)

Deemed to be University

Vallam, Thanjavur - 613 403.

Registration Form

1. Name: _____
2. Reg. No.: _____
3. Programme & Branch: _____
4. Name of value added course: _____
5. E-mail: _____
6. Mobile No: _____

Signature

Submission of application form

Filled in application form has to be submitted in person to course coordinator. Last date for registration is **12.07.2023.**

Head of the Department,
Department of Physics,
PRIST Deemed to be University,
Vallam,
Thanjavur – 613403.

Upon successful completion of the course,
the Head, Department of Physics will be provided.

PRIST Deemed to be University,
Vallam, Thanjavur-613403.

Tamil Nadu, India. *S. S. S. S.*

About PRIST

Ponnaiyah Ramajayam Institute of Science and Technology (PRIST), a Deemed University (U/s 3 of the UGC Act 1956), is one of the renowned units of Ponnaiyah Ramajayam Institutions, which are serving for more than 30 years in promoting quality education and research for our Indian community, since its inception. The institution is now brimming with many social responsibilities, particularly in promoting quality education through research.

About School of Arts and Science

School of Arts and Sciences consists of Tamil, English, Mathematics, Physics, Chemistry, Biochemistry, Biotechnology, and Microbiology departments. It offers B. Sc., M.Sc. M.Phil. and Ph.D. programmes in all disciplines. It comprises of well qualified and research oriented faculty members whose are experts in the frontier areas in Sciences. Faculty members have received research projects from various funding agencies such as DST, CSIR, DRDO, and ICMR.

About Physics Department

The Physics Department offers credit based undergraduate programme, Bachelor of Science (B.Sc.) in Physics, postgraduate programme, Master of Science (M.Sc.) in Physics and Ph.D. programmes. The Department also offers credit based core and elective courses in basic Physics to undergraduate first year engineering (B.Tech)

The Head, Department of Physics,

PRIST Deemed to be University,
Vallam, Thanjavur-613403.

Tamilnadu, India.



List of topics covered in the programme

Unit I - Thermodynamics of Crystal Growth

Saturation and super saturation – solubility curve – expression for super saturation–solubility diagram

–nucleation – Theories of nucleation – Gibbs Thomson equation for vapour –Modified Thomson's equation for melt – Gibbs Thomson equation for solution – Kinetic of crystal growth– Single and rough faces – Models of surface roughness - KSU theory and BCF theory.

Unit II - Growth from solutions

Low temperature solution growth: Slow cooling process – solvent evaporation process –Temperature difference process – Use of electrolytic process high temperature solution growth: Solvent & methods – slow cooling methods – temperature difference methods – high pressure method – solvent evaporation method – electrolytic process - liquid phase epitaxial.

Unit III - Growth from melt

Bridgeman and related techniques – crystal pulling – convection in melts – modeling and simulation of bulk crystal growth considering melt growth – Czochralski technique – zone melting technique – skull melting process – Verneuil process-Heat exchange method.

Unit IV - Other Crystal Growth Techniques

Physical vapour deposition–chemical vapour deposition – chemical vapour transport –definition – fundamentals – choice of transport reactions – specifications – Transported materials and agents- STP, LTVP,OTP-Hydrothermal growth: Design aspect of autoclave-electro crystallization-Gel method: principle-types of gels-structure of gels-growth in gels-experimental procedure-biological crystallization.

Unit V - Analysis and Characterization of Crystals

Optical transmission studies (UV) Micro hardness studies-Structural analysis-XRD-Fourier Transform-IR-Spectral analysis-Scanning Electron Microscopy (SEM)-different etching techniques.

School of Arts & Sciences
Ponnaiyah Ramajayam Institute of
Science & Technology (PRIST)

Deemed to be University

Vallam, Thanjavur - 613 403.



PONNAIYAH RAMAJAYAM INSTITUTE OF SCIENCE & TECHNOLOGY (PRIST)

Declared as DEEMED-TO-BE-UNIVERSITY
Via 3 of UGC Act, 1956

CRYSTAL GROWTH ANALYSIS

Course Objectives:

This course is designed to provide a detailed study on Ceramic materials and their applications in devices. The prerequisite for this would be to do a first course on concepts of materials science.

Course Outcomes:

At the end of this course, students will have a thorough knowledge of functional ceramic materials. Know the methods of synthesis of functional ceramics. Acquire knowledge of how to choose ceramic materials for specific applications.

Unit I - Thermodynamics of Crystal Growth

Saturation and super saturation – solubility curve – expression for super saturation–solubility diagram –nucleation – Theories of nucleation – Gibbs Thomson equation for vapour –Modified Thomson's equation for melt – Gibbs Thomson equation for solution – Kinetic of crystal growth– Single and rough faces – Models of surface roughness - KSU theory and BCF theory.

Unit II - Growth from solutions

Low temperature solution growth: Slow cooling process – solvent evaporation process –Temperature difference process – Use of electrolytic process high temperature solution growth: Solvent & solutions - slow cooling methods – temperature difference methods – high pressure method – solvent evaporation method – electrolytic process - liquid phase epitaxial.

Unit III - Growth from melt

Bridgeman and related techniques – crystal pulling – convection in melts – modeling and simulation of bulk crystal growth considering melt growth – czocharalski technique – zone melting technique – skull melting process – verneuil process-Heat exchange method.

Unit IV - Other Crystal Growth Techniques

Physical vapour deposition-chemical vapour deposition – chemical vapour transport –definition – fundamentals – choice of transport reactions – specifications – Transported materials and agents-STP,LTVTP,OTP-Hydrothermal growth: Design aspect of autoclave-electro crystallization-Gel method: principle-types of gels-structure of gels-growth in gels-experimental procedure-biological crystallization.

Unit V - Analysis and Characterization of Crystals

Optical transmission studies (UV) Micro hardness studies-Structural analysis-XRD-Fourier Transform-IR-Spectral analysis-Scanning Electron Microscope (SEM)-different etching techniques.

Books for Reference:

1. Brice J.C, Crystal Growth Processes, John Wiley & sons , New York 1986,
2. Santhanaraghavan P, Ramasamy . P, Crystal Growth – Process and Methods, KRU Publications, Kumbakonam, 2000.
3. Buckley H.E, Crystal Growth, John Wiley & Sons, New York, 1986.
4. Gilman J, The Art of Science of Growing Crystals, John Wiley & Sons, New York, 1956.

The Head, Department of Physics,
PRIST Deemed to be University,
Vallam, Thanjavur-613403.

DEAN
School of Arts & Science
Ponnaiyah Ramajayam Institute of
Science & Technology (PRIST)
Deemed to be University,
Vallam, Thanjavur - 613403

Registration Form

1. Name: _____
2. Reg. No.: _____
3. Programme & Branch: _____
4. Name of value added course: _____
5. E-mail: _____
6. Mobile No: _____

Signature

Submission of application form

Filled in application form has to be submitted in person to course coordinator. Last date for registration is **12.07.2023.**

Head of the Department,
Department of Physics,
PRIST Deemed to be University,
Vallam,
Thanjavur – 613403.

Upon successful completion of the course, certificate will be provided.

S. S. S.
The Head, Department of Physics,
PRIST Deemed to be University,
Vallam, Thanjavur-613403.
Tamilnadu, India.



**PONNAIYAH RAMAJAYAM INSTITUTE OF
SCIENCE & TECHNOLOGY (PRIST)**
DEEMED TO BE UNIVERSITY
UIN 3 of UGC Act, 1986

Value Added Course

**Industry Linked Optical Fiber
Technology**



Organized by

**Department of Physics
School of Arts and Science**

**PONNAIYA RAMAJAYAM INSTITUTE OF
SCIENCE & TECHNOLOGY**

Thanjavur 613 403

D. Tamil Nadu
School of Arts & Science

Ponnaiyah Ramajayam Institute of
Science & Technology (PRIST)
Deemed to be University
Vallam, Thanjavur - 613 403.

About PRIST

Ponnaiyah Ramajayam Institute of Science and Technology (PRIST), a Deemed University (U/s 3 of the UGC Act 1956), is one of the renowned units of Ponnaiyah Ramajayam Institutions, which are serving for more than 30 years in promoting quality education and research for our Indian community, since its inception. The institution is now brimming with many social responsibilities, particularly in promoting quality education through research.

About School of Arts and Science

School of Arts and Sciences consists of Tamil, English, Mathematics, Physics, Chemistry, Biochemistry, Biotechnology, and Microbiology departments. It offers B. Sc., M.Sc. M.Phil. and Ph.D. programmes in all disciplines. It comprises of well qualified and research oriented faculty members whose are experts in the frontier areas in Sciences. Faculty members have received research projects from various funding agencies such as DST, CSIR, DRDO, and ICMR.

About Physics Department

The Physics Department offers credit based undergraduate programme, Bachelor of Science (B.Sc.) in Physics, postgraduate programme, Master of Science (M.Sc.) in Physics and Ph.D. programmes. The Department also offers credit based core and elective courses in basic Physics to undergraduate first year engineering (B.Tech) students.

The Head, Department of Physics,
PRIST Deemed to be University,
Vallam, Thanjavur-613403.
Tamilnadu, India.

List of topics covered in the programme

Unit 1- Introduction

Need for optical communication, salient features of optical fibers, ray theory of light guidance, numerical aperture, modes of a fiber, single and multimode fibers, step-index and graded-index fibers.

Transmission characteristics of optical fibers, attenuation, pulse broadening mechanism, intermodal dispersion, bit rate - length product, material dispersion.

Unit 2- Basic Optical Communications Concepts

P2P System, Transmitter, Light Source, LED, Laser Diode, Detector, PIN diode, Avalanche PhotoDiode, Optical Amplifiers, EDFA, PDFA, Regeneration, ADM, OADM, Digital Cross Connect, RPR Ring.

Unit 3- Optical Fiber

Core, Cladding, Primary Buffer, Types of Fibers, Silica Core Silica Cladding, Silica Core, Plastic Cladding (PCS), Plastic Core Plastic Cladding (POF), fiber fabrication techniques.

Unit 4- Cable Splicing

Fusion Splicing, Mechanical Splicing, Single Fiber Fusion Splicing, Mass Fusion Splicing, Stages of Splicing, Splicing Precautions, Misalignment, End Gap, End Angle, NA Mismatch, Core Mismatch, Waisting, Bulging, Axial Run-out, Bubble, Incomplete Fusion.

Unit 5- Testing of Cables

Continuity Test, Light Source- Power Meter, OLTS, Visual Fault Locator, OTDR Testing, Measuring Cable Span, Attenuation Coefficient, Connector/ Splice Loss Measurement, Distance to Fault, OTDR Trace Analysis, Optical Loss Budget.

DEAN

School of Arts & Science
Ponnaiyah Ramajayam Institute of
Science & Technology (PRIST)
Deemed to be University
Vallam, Thanjavur - 613 403.



**PONNAIYAH RAMAJAYAM INSTITUTE OF
SCIENCE & TECHNOLOGY (PRIST)**

Declared as DEEMED-TO-BE UNIVERSITY
U/s 3 of UGC Act, 1956

Department of Physics

Subject Code	Subject Name
22513OFT	Certificate course on industry linked optical fiber technology

Total : 45 hours

Syllabus

COURSE OBJECTIVES:

1. To realize the significance of optical fiber communications.
2. To understand the construction and characteristics of optical fiber cable.
3. To develop the knowledge of optical signal sources and power launching.
4. To identify and understand the operation of various optical detectors.
5. To under the design of optical systems and WDM.

Unit 1- Introduction

Need for optical communication, salient features of optical fibers, ray theory of light guidance, numerical aperture, modes of a fiber, single and multimode fibers, step-index and graded-index fibers.

Transmission characteristics of optical fibers, attenuation, pulse broadening mechanism, intermodal dispersion, bit rate - length product, material dispersion.

Unit 2- Basic Optical Communications Concepts

P2P System, Transmitter, Light Source, LED, Laser Diode, Detector, PIN diode, Avalanche Photo Diode, Optical Amplifiers, EDFA, PDFA, Regeneration, ADM, OADM, Digital Cross Connect, RPR Ring.

Unit 3- Optical Fiber

Core, Cladding, Primary Buffer, Types of Fibers, Silica Core Silica Cladding, Silica Core, Plastic Cladding (PCS), Plastic Core Plastic Cladding (POF), fiber fabrication techniques.

Unit 4- Cable Splicing

Fusion Splicing, Mechanical Splicing, Single Fiber Fusion Splicing, Mass Fusion Splicing, Stages

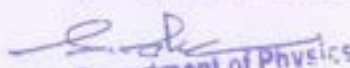
The Head, Department of Physics,
PRIST Deemed to be University,
Vallam, Thanjavur-613403.
Tamil Nadu, India.

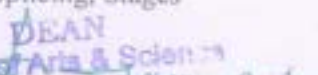
DEAN
School of Arts & Sciences
Ponnaiyah Ramajayam Institute
of Science & Technology (PRIST)
Deemed to be University
Vallam, Thanjavur - 613403

of Splicing, Splicing Precautions, Misalignment, End Gap, End Angle, NA Mismatch, Core Mismatch, Waisting, Bulging, Axial Run-out, Bubble, Incomplete Fusion

Unit 5- Testing of Cables

Continuity Test, Light Source- Power Meter, OLTS, Visual Fault Locator, OTDR Testing, Measuring Cable Span, Attenuation Coefficient, Connector/ Splice Loss Measurement, Distance to Fault, OTDR Trace Analysis, Optical Loss Budget.

TEXT BOOKS:

1. Optical Fiber Communications – Gerd Keiser, Tata Mc Graw-Hill International edition, 4th Edition, 2008.

2. Optical Fiber Communications – John M. Senior, PHI, 2nd Edition, 2002. REFERENCE BOOKS:

1. Fiber Optic Communications – D.K. Mynbaev , S.C. Gupta and Lowell L. Scheiner, Pearson Education, 2005.

2. Text Book on Optical Fibre Communication and its Applications – S.C.Gupta, PHI, 2005. 3. Fiber Optic Communication Systems – Govind P. Agarwal , John Wiley, 3rd Edition, 2004.

4. Fiber Optic Communications – Joseph C. Palais, 4th Edition, Pearson Education, 2004.

COURSE OUTCOMES:

At the end of the course the student will be able to:

1. Understand and analyze the constructional parameters of optical fibers.
2. Be able to design the optical system.
3. Estimate the losses due to attenuation, absorption, scattering and bending.
4. Compare various optical detectors and choose suitable one for different applications.

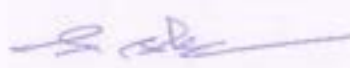
The Head, Department of Physics
PRIST Deemed to be University,
Vellore, Thanjavur-613403.
Tamil Nadu India.

DEAN
School of Arts & Science
Ponnalyah Ramajeyam Institute of
Science & Technology (PRIST)
Deemed to be University
Vellore, Thanjavur - 613 403.

Registration Form

1. Name: _____
2. Reg. No.: _____
3. Programme & Branch: _____
4. Name of value added course: _____
5. E-mail: _____
6. Mobile No: _____

Signature of the applicant

Submission of application form

Filled in application form has to be submitted in person to course coordinator. Last date for registration is **12.07.2023.**

Head of the Department,
Department of Physics,
PRIST Deemed to be University,
Vallam,
Thanjavur – 613403.

Upon successful completion of the course, certificate will be provided.

The Head, Department of Physics,
PRIST Deemed to be University,
Vallam, Thanjavur-613403.
Tamilnadu, India.



**PONNAIYAH RAMAJAYAM INSTITUTE OF
SCIENCE & TECHNOLOGY (PRIST)**
Deemed to be University
UFA 3 of OBC Act, 1994

Value Added Course
Installation and maintenance of
digital circuits



Organized by
Department of Physics
School of Arts and Science

**PONNAIYA RAMAJAYAM INSTITUTE OF
SCIENCE & TECHNOLOGY**
Thanjavur 613 403

DE Tamil Nadu
School of Arts & Science
Ponnaiyah Ramajayam Institute of
Science & Technology (PRIST)
Deemed to be University
Vellam, Thanjavur - 613 403.

About PRIST

Ponnaiyah Ramajayam Institute of Science and Technology (PRIST), a Deemed University (U/s 3 of the UGC Act 1956), is one of the renowned units of Ponnaiyah Ramajayam Institutions, which are serving for more than 30 years in promoting quality education and research for our Indian community, since its inception. The institution is now brimming with many social responsibilities, particularly in promoting quality education through research.

About School of Arts and Science

School of Arts and Sciences consists of Tamil, English, Mathematics, Physics, Chemistry, Biochemistry, Biotechnology, and Microbiology departments. It offers B. Sc., M.Sc. M.Phil. and Ph.D. programmes in all disciplines. It comprises of well qualified and research oriented faculty members whose are experts in the frontier areas in Sciences. Faculty members have received research projects from various funding agencies such as DST, CSIR, DRDO, and ICMR.

About Physics Department

The Physics Department offers credit based undergraduate programme, Bachelor of Science (B.Sc.) in Physics, postgraduate programme, Master of Science (M.Sc.) in Physics and Ph.D. programmes. The Department also offers credit based core and elective courses in basic Physics to undergraduate first year engineering (B.Tech) students.

S. Sk
The Head, Department of Physics,
PRIST Deemed to be University,
Vallam, Thanjavur-613403,
Tamilnadu, India.

List of topics covered in the programme

Unit 1

Digital System and Binary Numbers: Number System and its arithmetic, Signed binary numbers, Binary codes, Cyclic codes, Hamming Code, the map method up to five variable, Don't care conditions, POS simplification, NAND and NOR implementation, Quine McClusky method (Tabular method).

Unit 2

Combinational Logic: Combinational Circuits: Analysis Procedure, Design procedure, Binary adder, subtractor, Decimal adder, Binary multiplier, Magnitude comparator, Multiplexers, Demultiplexers, Decoders, Encoders.

Unit 3

Sequential Logic and Its Applications: Storage elements: latches & flip Flops, Characteristic Equations of Flip Flops, Flip Flop Conversion, Shift Registers, Ripple Counters, Synchronous Counters, Other Counters: Johnson & Ring Counter.

Unit 4

Synchronous & Asynchronous Sequential Circuits: Analysis of clocked sequential circuits with state machine designing, State reduction and assignments, Design procedure. Analysis procedure of Asynchronous sequential circuits, circuit with latches, Design procedure, Reduction of state and flow table, Race-free state assignment, Hazards.

Unit 5

Memory & Programmable Logic Devices: Digital Logic Families: DTL, DCTL, TTL, ECL & CMOS etc., Fan Out, Fan in, Noise Margin; RAM, ROM, PLA, PAL; Circuits of Logic Families, Interfacing of Digital Logic Families, Circuit implementation using ROM, PLA and PAL; CPLD and FPGA.

DEAN

[Signature]
School of Arts & Science
Ponnaiyah Ramajayam Institute of
Science & Technology (PRIST)
Deemed to be University
Vallam, Thanjavur - 613 403.



**PONNAIYAH RAMAJAYAM INSTITUTE OF
SCIENCE & TECHNOLOGY (PRIST)**

Declared as DEEMED-TO-BE-UNIVERSITY
U/s 3 of UGC Act, 1956

Department of Physics

Subject Code	Subject Name
22513DC	Certificate course on installation and maintenance of digital circuits

Total : 45 hours

Syllabus

Course Objectives:

The main objectives of this course are to:

1. To make student to understand the importance of digital electronic circuits
2. To bring exposure to various tools and equipment used for installation of digital electronic circuits.
3. To get hands-on training on the installation and maintenance of digital electronic circuits.
4. To bring knowledge on the possibility of Employability and Entrepreneurship avenues in the area of digital electronic circuits.

Unit 1

Digital System and Binary Numbers: Number System and its arithmetic, Signed binary numbers, Binary codes, Cyclic codes, Hamming Code, the map method up to five variable, Don't care conditions, POS simplification, NAND and NOR implementation, Quine McClusky method (Tabular method).

Unit 2

Combinational Logic: Combinational Circuits: Analysis Procedure, Design procedure, Binary addersubtractor, Decimal adder, Binary multiplier, Magnitude comparator, Multiplexers, Demultiplexers, Decoders, Encoders.

Unit 3

Sequential Logic and Its Applications: Storage elements: latches & flip flops, Characteristic Equations of Flip Flops, Flip Flop Conversion, Shift Registers, Ripple Counters, Synchronous Counters, Other Counters: Johnson & Ring Counter.

Unit 4

Synchronous & Asynchronous Sequential Circuits: Analysis of clocked sequential circuits with state machine designing, State reduction and assignments, Design procedure. Analysis procedure of Asynchronous sequential circuits, circuit with latches, Design procedure, Reduction of state and flow table, Race-free state assignment, Hazards.

The Head, Department of Physics.
PRIST Deemed to be University,
Vallam, Thanjavur-613403,
Tamilnadu, India.

DEAN
School of Arts & Science
Ponnaiyah Ramajayam Institute of
Science & Technology (PRIST)
Deemed to be University
Vallam, Thanjavur - 613403

Unit 5

Memory & Programmable Logic Devices: Digital Logic Families: DTL, DCTL, TTL, ECL & CMOS etc., Fan Out, Fan in, Noise Margin; RAM, ROM, PLA, PAL; Circuits of Logic Families, Interfacing of Digital Logic Families, Circuit Implementation using ROM, PLA and PAL; CPLD and FPGA.

Course Outcomes

At the end of the course, trainees/students will be able to:

- 1 Apply concepts of Digital Binary System and implementation of Gates.
- 2 Analyze and design of Combinational logic circuits.
- 3 Analyze and design of Sequential logic circuits with their applications
- 4 Implement the Design procedure of Synchronous & Asynchronous Sequential Circuits
- 5 Apply the concept of Digital Logic Families with circuit implementation

References

1. M. Morris Mano and M. D. Ciletti, "Digital Design", Pearson Education.
2. David J. Comer, "Digital Logic & State Machine Design", Oxford University Press.
3. RP Jain, "Modern Digital Electronics", Tata McGraw Hill Publication.



The Head, Department of Physics,
PRIST Deemed to be University,
Vallam, Thanjavur-613403.
Tamilnadu, India.



DEAN
School of Arts & Sciences
Ponnalyah Ramaleeyam Institute of
Science & Technology (PRIST)
Deemed to be University
Vallam, Thanjavur - 613 403.

Registration Form

1. Name: _____
2. Reg. No.: _____
3. Programme & Branch: _____
4. Name of value added course: _____
5. E-mail: _____
6. Mobile No: _____

Signature

Submission of application form

Filled in application form has to be submitted in person to course coordinator. Last date for registration is **12.07.2023.**

Head of the Department,
Department of Physics,
PRIST Deemed to be University,
Vallam,
Thanjavur – 613403.

Upon successful completion of the course, certificate will be provided.

The Head, Department of Physics,
PRIST Deemed to be University,
Vallam Thanjavur-613403.
Tamil Nadu, India.



PONNAIYAH RAMAJAYAM INSTITUTE OF
SCIENCE & TECHNOLOGY (PRIST)
Declared as DEEMED TO BE UNIVERSITY
Via 3 of UGC Act, 1956

Value Added Course

Regulated Power Supply



Organized by

**Department of Physics
School of Arts and Science**

**PONNAIYA RAMAJAYAM INSTITUTE OF
SCIENCE & TECHNOLOGY**

Thanjavur 613 403

Dr. Tamil Nadu
DEAN

School of Arts & Science
Ponnaiyah Ramajayam Institute of
Science & Technology (PRIST)
Deemed to be University,
Thanjavur, Tamil Nadu, India.

About PRIST

Ponnaiyah Ramajayam Institute of Science and Technology (PRIST), a Deemed University (U/s 3 of the UGC Act 1956), is one of the renowned units of Ponnaiyah Ramajayam Institutions, which are serving for more than 30 years in promoting quality education and research for our Indian community, since its inception. The institution is now brimming with many social responsibilities, particularly in promoting quality education through research.

About School of Arts and Science

School of Arts and Sciences consists of Tamil, English, Mathematics, Physics, Chemistry, Biochemistry, Biotechnology, and Microbiology departments. It offers B. Sc., M.Sc., M.Phil. and Ph.D. programmes in all disciplines. It comprises of well qualified and research oriented faculty members whose are experts in the frontier areas in Sciences. Faculty members have received research projects from various funding agencies such as DST, CSIR, DRDO, and ICMR.

About Physics Department

The Physics Department offers credit based undergraduate programme, Bachelor of Science (B.Sc.) in Physics, postgraduate programme, Master of Science (M.Sc.) in Physics and Ph.D. programmes. The Department also offers credit based core and elective courses in basic Physics to undergraduate first year engineering (B.Tech) students.

The Head, Department of Physics,
PRIST Deemed to be University,
Vallam, Thanjavur-613403.

List of topics covered in the programme

Unit I

Basic elements (Resistor, Inductor & Capacitor) & its working. Colour coding of resistor & current rating of resistance. Transformers its principal working, types of transformer current rating of transformer. Multi-meter & testing of components using multi-meter

Unit II

Instantaneous current time period, frequency, wavelength, peak or maximum amplitude, peak to peak value, effective current or RMS value of current & voltage, the average current & Voltage, power in ac circuit. Phase & phase difference. Inductive reactance & capacitive reactance.

Unit III

Working of half wave, full wave & bridge rectifier. Rectifier with capacitor filter (shunt capacitor filter), with series inductor filter, LC filter & π - section filter, Ripple factor, efficiency & voltage regulation for each filter

Unit IV

Zener diode: Its working & characteristics, Zener diode as regulated power supply. Design consideration with one example.

Unit V

Concept of IC, Three pin IC regulator block diagram, 78xx series & 79xx series. Dual power supply.

DEAN

School of Arts & Science
Ponnaiyah Ramajayam Institute of
Science & Technology (PRIST)
Deemed to be University,
Vallam, Thanjavur - 613 403



**PONNAIYAH RAMAJAYAM INSTITUTE OF
SCIENCE & TECHNOLOGY (PRIST)**

Declared as DEEMED-TO-BE-UNIVERSITY
U/s 3 of UGC Act, 1956

Subject Code	Subject Name
23513RPS	Certificate course on Regulated Power Supply

Course Objectives:

To impart knowledge on

- Working principles of electrical and electronic circuits
- Operation of electrical and electronic circuits

Unit I

Basic elements (Resistor, Inductor & Capacitor) & its working. Colour coding of resistor & current rating of resistance. Transformers its principal working, types of transformer current rating of transformer. Multi-meter & testing of components using multi- meter

Unit II

Instantaneous current time period, frequency, wavelength, peak or maximum amplitude, peak to peak value, effective current or RMS value of current & voltage, the average current & Voltage, power in ac circuit. Phase & phase difference. Inductive reactance & capacitive reactance.

Unit III

Working of half wave, full wave & bridge rectifier. Rectifier with capacitor filter (shunt capacitor filter), with series inductor filter, LC filter & π - section filter. Ripple factor, efficiency & voltage regulation for each filter.

Unit IV

Zener diode: Its working & characteristics, Zener diode as regulated power supply. Design consideration with one example.

Unit V

Concept of IC, Three pin IC regulator block diagram, 78xx series & 79xx series. Dual power supply.

Course Outcomes:

At the end of the course the students will be able to

- Understand the working principles of electrical and electronic circuits
- Comprehend the operation of electrical and electronic circuits

REFERENCE BOOKS:

- 1) Electronic Circuits by A.P. Godse & U.A .Bakshi
- 2) Solid state electronics by Agarawal & Agarawal
- 3) Basics electronics by B.K. Bagade & Singh
- 4) Principles of electronics by Malivno
- 5) Electricity & magnetism by Murgeshan
- 6) Electricity & magnetism by Brijjal & Subramian

The Head, Department of Physics,
PRIST Deemed to be University,
Vallam, Thanjavur-613403.
Tamilnadu, India.

DEAN
School of Arts & Science
Ponnaiyah Ramajayam Institute of
Science & Technology (PRIST)
Deemed to be University
Vallam, Thanjavur - 613 403.

Registration Form

1. Name: _____
2. Reg. No.: _____
3. Programme & Branch: _____
4. Name of value added course: _____
5. E-mail: _____
6. Mobile No: _____

Signature

Submission of application form

Filled in application form has to be submitted in person to course coordinator. Last date for registration is **12.07.2023.**

Head of the Department,
Department of Physics,
PRIST Deemed to be University,
Vallam,
Thanjavur – 613403.

Upon successful completion of the course, certificate will be provided.

The Head, Department of Physics,
PRIST Deemed to be University,
Vallam, Thanjavur-613403,
Tamilnadu, India.



**PONNAIYAH RAMAJAYAM INSTITUTE OF
SCIENCE & TECHNOLOGY (PRIST)**
Deemed to be University
Via 3 of UBC Act, 1956

Value Added Course

Cosmology and structure formation



Organized by
Department of Physics
School of Arts and Science
**PONNAIYA RAMAJAYAM INSTITUTE OF
SCIENCE & TECHNOLOGY**

Thanjavur 613 403

Tamil Nadu

DEAN

School of Arts & Science
Ponnaiyah Ramajayam Institute of
Science & Technology (PRIST)
Deemed to be University
Vallam, Thanjavur - 613 403

About PRIST

Ponnaiyah Ramajayam Institute of Science and Technology (PRIST), a Deemed University (U/s 3 of the UGC Act 1956), is one of the renowned units of Ponnaiyah Ramajayam Institutions, which are serving for more than 30 years in promoting quality education and research for our Indian community, since its inception. The institution is now brimming with many social responsibilities, particularly in promoting quality education through research.

About School of Arts and Science

School of Arts and Sciences consists of Tamil, English, Mathematics, Physics, Chemistry, Biochemistry, Biotechnology, and Microbiology departments. It offers B. Sc., M.Sc. M.Phil. and Ph.D. programmes in all disciplines. It comprises of well qualified and research oriented faculty members whose are experts in the frontier areas in Sciences. Faculty members have received research projects from various funding agencies such as DST, CSIR, DRDO, and ICMR.

About Physics Department

The Physics Department offers credit based undergraduate programme, Bachelor of Science (B.Sc.) in Physics, postgraduate programme, Master of Science (M.Sc.) in Physics and Ph.D. programmes. The Department also offers credit based core and elective courses in basic Physics to undergraduate first year engineering (B.Tech) students.

The Head, Department of Physics,
PRIST Deemed to be University,
Vallam, Thanjavur-613403.

Tamiraparani, India. 

List of topics covered in the programme

Unit I

Introduction: observational and theoretical basis of the standard model

Unit II

The homogeneous universe - A minimal sketch of general relativity

Unit III

Homogeneous cosmological models (the Friedmann-Robertson Walker universe) Thumbnail sketch of cosmic history - The cosmic microwave background - Primordial nucleosynthesis Horizons and inflation

Unit IV

The inhomogeneous universe - Perturbation theory - Spherical collapse - The cold dark matter paradigm

Unit V

The cosmic expansion history and dark energy - Microwave background fluctuations - Large-scale structure - Galaxy formation



DEAN A
School of Arts & Science
Ponnaiyah Ramajayam Institute of
Science & Technology (PRIST)
Deemed to be University
Vallam, Thanjavur - 613403.



**PONNAIYAH RAMAJAYAM INSTITUTE OF
SCIENCE & TECHNOLOGY (PRIST)**

Declared as DEEMED-TO-BE-UNIVERSITY
U/s 3 of UGC Act, 1956

Subject Code	Subject Name
23513CSF	Certificate course on Cosmology and Structure Formation

Course Objectives

This course is a graduate-level introduction to astrophysical cosmology, with emphasis on the “standard” big bang theory of the universe and, in the latter part of the course, its extension to a more detailed theory (the inflation + cold dark matter + cosmological constant model) that is presently the leading scenario for explaining the origin of structure in the universe.

Unit I

Introduction: observational and theoretical basis of the standard model

Unit II

The homogeneous universe - A minimal sketch of general relativity

Unit III

Homogeneous cosmological models (the Friedmann-Robertson Walker universe) Thumbnail sketch of cosmic history - The cosmic microwave background - Primordial nucleosynthesis Horizons and inflation

Unit IV

The inhomogeneous universe - Perturbation theory- Spherical collapse - The cold dark matter paradigm

Unit V

The cosmic expansion history and dark energy - Microwave background fluctuations - Large-scale structure- Galaxy formation

Course Outcomes:

At the end of the course the students will be able to

- Know the “standard” big bang theory of the universe
- Realize the origin of structure in the universe

References

1. Ryden, *Introduction to Cosmology*
2. Kolb and Turner, *The Early Universe*
3. Padmanabhan, *Structure Formation in the Universe*
4. Peacock, *Cosmological Physics*
5. Peebles, *Principles of Physical Cosmology*

The Head, Department of Physics,
PRIST Deemed to be University,
Vallamthangal, P. 613403,
Tamilnadu, India.

DEAN
School of Arts & Science
Ponnaiyah Ramajayam Institute of
Science & Technology (PRIST)
Deemed to be University
Vallam, Thanjavur - 613 403.



**PONNAIYAH RAMAJAYAM INSTITUTE OF
SCIENCE & TECHNOLOGY (PRIST)**

Declared as DEEMED TO BE UNIVERSITY
U/s 3 of UGC Act, 1956

**SCHOOL OF ARTS AND SCIENCE
DEPARTMENT OF PHYSICS**

Circular

PRIST/A&S/PH/23-24/12

Date: 25.01.2024

This is to inform all physics students that the value added courses classes for academic year 2023-24 even semester will be commenced from 02.02.2024. Hence requesting all registered students to attend the classes without fail.

1. Certificate course on installation and maintenance of solar photovoltaic systems
2. Certificate course on microcontroller

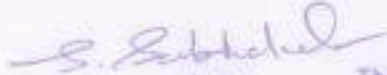
HOD

The Head, Department of Physics,
PRIST Deemed to be University,
Vallam, Thanjavur-613403,
Tamilnadu, India.

DEAN

DEAN
School of Arts & Science
Ponnaiyah Ramajayam Institute of
Science & Technology (PRIST)
Deemed to be University
Vallam, Thanjavur - 613 403.

Copy to:

1. Hon'ble Vice Chancellor (for your kind information)
2. Registrar
3. Registrar office
4. Dean
5. Department file

Registration Form

1. Name: _____
2. Reg. No.: _____
3. Programme & Branch: _____
4. Name of value added course: _____
5. E-mail: _____
6. Mobile No: _____

Signature of the applicant

Submission of application form

Filled in application form has to be submitted in person to course coordinator. Last date for registration is 29.01.2024.

Head of the Department,
Department of Physics,
PRIST Deemed to be University,
Vallam,
Thanjavur – 613403.

Upon successful completion of the course, certificate will be provided.

The Head, Department of Physics,
PRIST Deemed to be University,
Vallam, Thanjavur-613403.
Tamilnadu, India.



PONNAIYAH RAMAJAYAM INSTITUTE OF
SCIENCE & TECHNOLOGY (PRIST)

Declared as DEEMED-TO-BE UNIVERSITY
DUE 3 of UGC Act, 1956

Value Added Course

**Installation and Maintenance of Solar
Photovoltaic Systems**



Organized by

**Department of Physics
School of Art; and Science**

**PONNAIYA RAMAJAYAM INSTITUTE OF
SCIENCE & TECHNOLOGY**

Thanjavur 613 403

PRIST
School of **Tamil Nadu**
Ponnaiyah Ramajayam Institute of
Science & Technology (PRIST)
Deemed to be University,
Vallam, Thanjavur - 613 403.

About PRIST

Ponnaiyah Ramajayam Institute of Science and Technology (PRIST), a Deemed University (U/s 3 of the UGC Act 1956), is one of the renowned units of Ponnaiyah Ramajayam Institutions, which are serving for more than 30 years in promoting quality education and research for our Indian community, since its inception. The institution is now brimming with many social responsibilities, particularly in promoting quality education through research.

About School of Arts and Science

School of Arts and Sciences consists of Tamil, English, Mathematics, Physics, Chemistry, Biochemistry, Biotechnology, and Microbiology departments. It offers B. Sc., M.Sc. M.Phil. and Ph.D. programmes in all disciplines. It comprises of well qualified and research oriented faculty members whose are experts in the frontier areas in Sciences. Faculty members have received research projects from various funding agencies such as DST, CSIR, DRDO, and ICMR.

About Physics Department

The Physics Department offers credit based undergraduate programme, Bachelor of Science (B.Sc.) in Physics, postgraduate programme, Master of Science (M.Sc.) in Physics and Ph.D. programmes. The Department also offers credit based core and elective courses in basic Physics to undergraduate first year engineering (B.Tech) students.

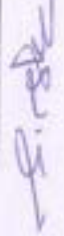
The Head, Department of Physics,
PRIST Deemed to be University,
Vailam, Thanjavur-613403.
Tamilnadu, India.

List of topics covered in the programme

Unit 1- Introduction

An Introduction: Energy from the Sun-Sun Path Diagram and Solar Radiation

Unit 2- Fundamentals of Solar Photovoltaic Systems

Components of a Solar PV System-Types of Solar Photovoltaic Systems-Technical Parameters and Performance of a Solar PV Panel. Identification and Uses of Tools and Equipment Used for Solar PV Installation.

Unit 3- Installation of Solar Photovoltaic Systems

The Importance of Accurate Load and Site Assessment-Steps for Conducting a Load Assessment-Steps for Conducting a Site Assessment-Procurement of the Solar PV System Components- Civil and Mechanical Parts of Solar PV System-Construction of Equipment

Unit 4- Components of Solar Photovoltaic Systems

Foundation-Installation of Mounting System, Photovoltaic Module and Battery Bank and inverter stands, Installation of Electrical Components, Conduits, Cables- Installation of Grounding Systems and Battery Bank.

Unit 5- Test & Measurement and Maintenance of Solar Photovoltaic Systems

Tools and Accessories Required for PV System Testing-Overall System Inspection-Testing of Solar Array-Wire and Earthing Continuity Tests-Testing of Charge Controller-Testing of Batteries-Start-up the System-Unintentional Islanding Functionality Tests-Sample Test and Commission Record Sheet-Tools Required for Maintenance-Preventive Maintenance of PV System-Troubleshooting and Maintenance.

DEAN

School of Arts & Science

Ponnaiyah Ramajayam Institute of Science and Technology

Deemed to be University

Vailam, Thanjavur-613403

Tamilnadu, India



**PONNAIYAH RAMAJAYAM INSTITUTE OF
SCIENCE & TECHNOLOGY (PRIST)**

Declared as DEEMED-TO-BE-UNIVERSITY
U/s 3 of UGC Act, 1956

Department of Physics

Subject Code	Subject Name
22513SPS	Certificate course on installation and maintenance of solar photovoltaic systems

Total : 45 hours

Syllabus

Course Objectives:

The main objectives of this course are to:

1. To make student to understand the importance of solar energy and its effective utilization.
2. To bring exposure to various tools and equipment used for Solar Photovoltaic installation.
3. To get hands-on training on the installation and maintenance of Solar Photovoltaic Systems.
4. To bring knowledge on the possibility of Employability and Entrepreneurship avenues in the area of solar energy extraction and utilization.

Unit 1- Introduction

An Introduction: Energy from the Sun-Sun Path Diagram and Solar Radiation

Unit 2- Fundamentals of Solar Photovoltaic Systems

Components of a Solar PV System-Types of Solar Photovoltaic Systems-Technical Parameters and Performance of a Solar PV Panel. Identification and Uses of Tools and Equipment Used for Solar PV Installation.

Unit 3- Installation of Solar Photovoltaic Systems

The Importance of Accurate Load and Site Assessment-Steps for Conducting a Load Assessment-Steps for Conducting a Site Assessment-Procurement of the Solar PV System Components-Civil and Mechanical Parts of Solar PV System-Construction of Equipment

Unit 4- Components of Solar Photovoltaic Systems

Foundation-Installation of Mounting System, Photovoltaic Module and Battery Bank and inverter stands. Installation of Electrical Components, Conduits, Cables- Installation of Grounding Systems and Battery Bank.

Unit 5- Test & Measurement and Maintenance of Solar Photovoltaic Systems

Tools and Accessories Required for PV System Testing-Overall System Inspection-Testing of Solar Array-Wire and Earthing Continuity Tests-Testing of Charge Controller-Testing of

The Head, Department of Physics
PRIST Deemed to be University,
Vallam, Thanjavur-613403.
Tamilnadu, India.

DEAN
School of Arts & Science
Ponnaiyah Ramajayam Inst
Science & Technology (PRIST)
Deemed to be University
Vallam, Thanjavur - 613 403.

Batteries-Start-up the System-Unintentional Islanding Functionality Tests-Sample Test and Commission Record Sheet-Tools Required for Maintenance-Preventive Maintenance of PV System-Troubleshooting and Maintenance.

Course Outcomes

At the end of the course, trainees/students will be able to:

- 1 Gain knowledge on renewable energy sources, solar PV systems, potential, and applications.
- 2 Analyze the solar geometry, system parameters, challenges, and opportunities.
- 3 Understand the system sizing, costing, installation, and operation with and without storage systems.
- 4 Development of solar PV systems for domestic, commercial, and industrial applications.
- 5 Performance analysis of a solar PV system for livelihood development.
- 6 Develop an understanding of the perspective on SDGs 7, 8, and 13.

References

1. Solar energy by Sukhatme, Tata McGraw-Hill Education, 1987.
2. Solar Energy Utilization Edited by Hafit Yüncü, E. Paykoc, Y. Yener, Springer Netherlands, 1987.
3. Solar Energy Utilization: A Textbook for Engineering Students by G. D. Rai Khanna Publishers, 1987.

The Head, Department of Physics,
Pondicherry Deemed to be University,
Karaikal, Thanjavur-613403,
Tamil Nadu, India.

DEAN
School of Arts & Science,
Ponnaiyah Ramajayam Institute of
Science & Technology (PRTI)
Deemed to be University,
Karaikal, Thanjavur - 613403.

Registration Form

1. Name: _____
2. Reg. No.: _____
3. Programme & Branch: _____
4. Name of value added course: _____
5. E-mail: _____
6. Mobile No: _____

Signature of the applicant

Submission of application form

Filled in application form has to be submitted in person to course coordinator. Last date for registration is **29.01.2024.**

Head of the Department,
Department of Physics,
PRIST Deemed to be University,
Vallam,
Thanjavur – 613403.

Upon successful completion of the course, certificate will be provided.

S. S. S.
The Head, Department of Physics,
PRIST Deemed to be University,
Vallam, Thanjavur-613403.
Tamilnadu, India.



**PONNAIYAH RAMAJAYAM INSTITUTE OF
SCIENCE & TECHNOLOGY (PRIST)**

Declared as Deemed-to-be University
Df. 3 of UGC Act, 1956

Value Added Course

Microcontroller



Organized by

**Department of Physics
School of Arts and Science**

**PONNAIYA RAMAJAYAM INSTITUTE OF
SCIENCE & TECHNOLOGY
Thanjavur 613 403**

Tamil Nadu

**School of Arts & Science
Ponnaiyah Ramajayam Institute of
Science & Technology (PRIST)
Deemed to be University
Vallam, Thanjavur - 613 403**

About PRIST

Ponnaiyah Ramajayam Institute of Science and Technology (PRIST), a Deemed University (U/s 3 of the UGC Act 1956), is one of the renowned units of Ponnaiyah Ramajayam Institutions, which are serving for more than 30 years in promoting quality education and research for our Indian community, since its inception. The institution is now brimming with many social responsibilities, particularly in promoting quality education through research.

About School of Arts and Science

School of Arts and Sciences consists of Tamil, English, Mathematics, Physics, Chemistry, Biochemistry, Biotechnology, and Microbiology departments. It offers B. Sc., M.Sc. M.Phil. and Ph.D. programmes in all disciplines. It comprises of well qualified and research oriented faculty members whose are experts in the frontier areas in Sciences. Faculty members have received research projects from various funding agencies such as DST, CSIR, DRDO, and ICMR.

About Physics Department

The Physics Department offers credit based undergraduate programme, Bachelor of Science (B.Sc.) in Physics, postgraduate programme, Master of Science (M.Sc.) in Physics and Ph.D. programmes. The Department also offers credit based core and elective courses in basic Physics to undergraduate first year engineering (B.Tech) students.

The Head, Department of Physics,
PRIST Deemed to be University,
Vallam, Thanjavur-613403.
Tamilnadu, India.

List of topics covered in the programme

Unit 1

Block diagram of microcontroller : CPU, input device, output device, memory and buses, common features of Microcontrollers : On-chip Oscillator, program and data memory, I/O Ports, Watchdog-timer reset, SFRs, Timers, Counters, Interrupts, ADC, PWM,

Unit 2

Blocks of Microcontroller 8051: ALU, PC, DPTR, PSW, Internal RAM, Internal ROM, Latch, SFRs, General purpose registers, Timer/Counter, Interrupt, Ports, Functions of each pin of 8051 Clock circuit, reset Circuit , phase and state in machine cycle of 8051, Memory organization of 8051: Program and Data memory Map, External Memory Addressing and Decoding Logic of 8051.

Unit 3

Addressing Modes : Immediate, Register, Direct, Indirect, Indexed, Relative and bit addressing, Instruction set :Data Transfer, Arithmetic, Logical, Branching, and Machine Control, Looping , Counting, sorting and Indexing. Data manipulation, Masking , Stack operation, Conditional programming,

Unit 4

Switch: Pushbutton, DIP, Thumbwheel, Tilt, Relay, LED, 7 segment LED, LCD, ADC0804, Temperature sensor LM35, DAC0808, ADC0804, Damper Control, Hoper Control, DC Motor, Stepper motor, Serial communication using MAX 232, Hyperterminal

Unit 5

Application of microcontroller in various field - Using LM35, ADCC0804, Microcontroller, 7 segment LED - Using Analog Multiplexer 4051, ADC0804, Microcontroller, 7 segment LED, MAX232 - Using GSM Modem, Microcontroller, Relay, Switches - Using Photo interrupter, Microcontroller, 7 Segment LED - Using Pushbutton switches, Microcontroller, Relay, NVRAM.

DEAN

School of Arts & Science
Ponnaiyah Ramajayam Institute of
Science & Technology (PRIST)
Deemed to be University
Vallam, Thanjavur - 613 403.



**PONNAIYAH RAMAJAYAM INSTITUTE OF
SCIENCE & TECHNOLOGY (PRIST)**

Declared as DEEMED-TO-BE-UNIVERSITY
U/s 3 of UGC Act, 1956

Department of Physics

Subject Code	Subject Name
22513DC	Certificate course on microcontroller

Total : 45 hours

Syllabus

Course Objectives:

The main objectives of this course are to:

1. To make student to know the significance of microcontroller
2. To convey details about several tools about microcontroller
3. To acquire hands-on training on the maintenance of microcontroller
4. To transfer knowledge on the possibility of Employability and Entrepreneurship avenues in the field of microcontroller

Unit 1

Block diagram of microcontroller : CPU, input device, output device, memory and buses, common features of Microcontrollers : On-chip Oscillator, program and data memory, I/O Ports, Watchdog-timer reset, SFRs, Timers, Counters, Interrupts, ADC, PWM, microprocessor and microcontroller, Hierarchy of microcontrollers, architectures of microcontroller Harvard, Von Neumann RISC and CISC, Applications: House hold, Communication, Office equipment and industrial automation

Unit 2

Blocks of Microcontroller 8051: ALU, PC, DPTR, PSW, Internal RAM, Internal ROM, Latch, SFRs, General purpose registers, Timer/Counter, Interrupt, Ports, Functions of each pin of 8051 Clock circuit, reset Circuit, phase and state in machine cycle of 8051, Memory organization of 8051: Program and Data memory Map, External Memory Addressing and Decoding Logic of 8051, Stack, Stack Pointer and Stack operation, Timers/Counters logic diagram and its operation in various modes, I/O Ports structure: Port 0, Port 1, Port2, Port 3., Serial Communication in various modes, Interrupt structure, vector address, priority and operation

Unit 3

Addressing Modes : Immediate, Register, Direct, Indirect, Indexed, Relative and bit addressing, Instruction set :Data Transfer, Arithmetic, Logical, Branching, and Machine Control, Looping, Counting, sorting and Indexing, Data manipulation, Masking, Stack operation, Conditional programming, Configuration and programming of Timer/Counter using SFRs: TMOD, TCON,

The Head, Department of Physics,
PRIST Deemed to be University,
Vallam Thaniavur-613403,
Tamil Nadu India.

DEAN
School of Arts & Science
Ponnaiyah Ramajayam Institute of
Science & Technology (PRIST)
Deemed to be University
Vallam, Thanjavur - 613403

THx, TLx., Configuration and programming of interrupts using SFRs: IE,IP,Configuration and programming of I/O Port : P0,P1,P2,P3

Unit 4

Switch: Pushbutton, DIP, Thumbwheel, Tilt, Relay,LED,7 segment LED, LCD, ADC0804, Temperature sensor LM35, DAC0808, ADC0804, Damper Control, Hoper Control, DC Motor, Stepper motor, Serial communication using MAX 232,Hyperterminal

Unit 5

Application of microcontroller in various field - Using LM35, ADCC0804, Microcontroller, 7 segment LED - Using Analog Multiplexer 4051,ADC0804,Microcontroller, 7 segment LED,MAX232 - Using GSM Modem, Microcontroller, Relay, Switches - Using Photo interrupter, Microcontroller, 7 Segment LED - Using Pushbutton switches, Microcontroller, Relay, NVRAM.

Course Outcomes

- i. At the end of the course, trainees/students will be able to:
 - I Identify features of various microcontroller
- ii. Select appropriate microcontroller for different application
- iii. Interface microcontroller with hardware for given application
- iv. Write and execute assembly language programs(software) for given application
- v. Develop small microcontroller based applications.

References

1. Microcontrollers : Principles And Applications Pal Ajit EEE, PHI ,New Delhi,(Latest edition)
2. The 8051 Microcontrollers: Architecture, Programming and Applications Rao Dr. K Uma Pearson Education India, New Delhi,(Latest edition)
- 3.The 8051 microcontroller and embedded systems Mazidi Ali, Muhammad Mazidi Gillispie Janice PHI, New Delhi,(Latest edition)
4. The 8051 Microcontroller: Architecture, Programming, and Applications Kenneth Ayala J. Thomson Delmar learning,(latest Edition)
5. The 8051 Microcontroller, Mackenzie Pearson Education India, New Delhi,(Latest edition)
- 6.Programming and customizing the 8051 microcontroller Predko Michael McGraw-Hill, International edition

The Head, Department of Physics
PRIST Deemed to be University,
Vallam, Thanjavur-613403.
Tamilnadu, India.

DEAN
School of Arts & Science
Ponnalyah Ramajayam Institute of
Science & Technology (PRIST)
Deemed to be University
Vallam, Thanjavur - 613 403.



PONNAIYAH RAMAJAYAM INSTITUTE OF SCIENCE & TECHNOLOGY (PRIST)

Declared as DEEMED TO BE UNIVERSITY
U/s 3 of UGC Act, 1956

**DEPARTMENT OF PHYSICS
DIPLOMA COURSE ON CRYSTAL GROWTH ANALYSIS
STUDENTS ATTENDANCE
Academic Year 2023-2024
Odd semester**

S. No	REG.NO	NAME OF THE STUDENT	JULY 2023				AUGUST 2023					SEPTEMBER 2023					OCTOBER 2023														
			17	20	24	28	2	4	11	16	18	23	25	30	1	5	8	13	15	20	22	27	29	6	11	13	14	18	19	25	27
1.	2301PH10301	Velmarigan T	/	/	/	/	/	/	/	/	/	/	/	/	/	/	/	/	/	/	/	/	/	/	/	/	/	/	/	/	/
2.	2301PH10302	Manivaranan C	/	/	/	/	/	/	/	/	/	/	/	/	/	/	/	/	/	/	/	/	/	/	/	/	/	/	/	/	/
3.	2301PH10303	Samuel R	/	/	/	/	/	/	/	/	/	/	/	/	/	/	/	/	/	/	/	/	/	/	/	/	/	/	/	/	/
4.	2301PH10304	Jamilton S	/	/	/	/	/	/	/	/	/	/	/	/	/	/	/	/	/	/	/	/	/	/	/	/	/	/	/	/	/
5.	2301PH10305	Vasanthar M	/	/	/	/	/	/	/	/	/	/	/	/	/	/	/	/	/	/	/	/	/	/	/	/	/	/	/	/	/
6.	2301PH10306	Priya L	/	/	/	/	/	/	/	/	/	/	/	/	/	/	/	/	/	/	/	/	/	/	/	/	/	/	/	/	/
7.	2301PH10307	Sivasankari C	/	/	/	/	/	/	/	/	/	/	/	/	/	/	/	/	/	/	/	/	/	/	/	/	/	/	/	/	/
8.	2301PH10308	Sirasan C	/	/	/	/	/	/	/	/	/	/	/	/	/	/	/	/	/	/	/	/	/	/	/	/	/	/	/	/	/
	2301PH10309	Jagan S	/	/	/	/	/	/	/	/	/	/	/	/	/	/	/	/	/	/	/	/	/	/	/	/	/	/	/	/	/

[Signature]
DEAN

The Head, Department of Physics,
PRIST Deemed to be University,
Vallam, Thanjavur-613403,
Tamilnadu, India. *[Signature]*

School of Arts & Science
Ponnaiyah Ramajayam Institute of
Science & Technology (PRIST)
Deemed to be University
Vallam, Thanjavur, 613403



PONNAIYAH RAMAJAYAM INSTITUTE OF SCIENCE & TECHNOLOGY (PRIST)

Declared as DEEMED-TO-BE-UNIVERSITY
 U/s 3 of UGC Act, 1956

**DEPARTMENT OF PHYSICS
 DIPLOMA COURSE ON CRYSTAL GROWTH ANALYSIS
 STUDENTS ATTENDANCE
 Academic Year 2023-2024
 Even semester**

S. No	REG.NO	NAME OF THE STUDENT	FEBRUARY 2024							MARCH 2024							
			2	7	9	12	16	22	28	2	7	9	14	16	21	26	28
1.	2301PH10301	Velmurugan T	/	/	/	/	/	/	/	/	/	/	/	/	/	/	/
2.	2301PH10302	Manivannan C	/	/	/	/	/	/	/	/	/	/	/	/	/	/	/
3.	2301PH10303	Samivel B	/	/	/	/	/	/	/	/	/	/	/	/	/	/	/
4.	2301PH10304	Jamilton S	/	/	/	/	/	/	/	/	/	/	/	/	/	/	/
5.	2301PH10305	Vanmalar M	/	/	/	/	/	/	/	/	/	/	/	/	/	/	/
6.	2301PH10306	Priya L	/	/	/	/	/	/	/	/	/	/	/	/	/	/	/
7.	2301PH10307	Sivasankari C	/	/	/	/	/	/	/	/	/	/	/	/	/	/	/
8.	2301PH10308	Sirasan C	/	/	/	/	/	/	/	/	/	/	/	/	/	/	/
9.	2301PH10309	Jagan S	/	/	/	/	/	/	/	/	/	/	/	/	/	/	/
10.	2301PH10310	Rajesh kumar R	/	/	/	/	/	/	/	/	/	/	/	/	/	/	/

Handwritten signature

The Head, Department of Physics,
 PRIST Deemed to be University,
 Vallam, Thanjavur-613403.
 Tamilnadu, India. *Sub*

DEAN
 School of Arts & Science
 Ponnaiyah Ramajayam Institute of
 Science & Technology (PRIST)
 Deemed to be University
 Vallam, Thanjavur - 613403

12.	2301PH10312	Kaviyaranan R	/	/	/	/	/	/	/	/	/	/	/	/	/	/	/	/	/
13.	2301PH10313	Sudarkavi R	/	/	/	/	/	/	/	/	/	/	/	/	/	/	/	/	/
14.	2301PH10314	Parkavi R	/	/	/	/	/	/	/	/	/	/	/	/	/	/	/	/	/
15.	2301PH10315	Priyadarshini S	/	/	/	/	/	/	/	/	/	/	/	/	/	/	/	/	/
16.	2301PH10316	Rajinikanth K	/	/	/	/	/	/	/	/	/	/	/	/	/	/	/	/	/
17.	2301PH10317	Parvathal T	/	/	/	/	/	/	/	/	/	/	/	/	/	/	/	/	/
18.	2301PH10318	Maheshwari C	/	/	/	/	/	/	/	/	/	/	/	/	/	/	/	/	/
19.	2301PH10319	Soniya M	/	/	/	/	/	/	/	/	/	/	/	/	/	/	/	/	/
20.	2301PH10320	Seethalakshmi M	/	/	/	/	/	/	/	/	/	/	/	/	/	/	/	/	/
21.	2301PH10321	Ramam M	/	/	/	/	/	/	/	/	/	/	/	/	/	/	/	/	/
Staff Signature																			

The Head, Department of Physics,
 PRIST Deemed to be University,
 Vellam, Thanjavur-613403,
 Tamilnadu, India.

DEAN
 School of Arts & Science
 Ponnaiyah Ramajeyam Institute
 Science & Technology (PRIST)
 Deemed to be University
 Vellam, Thanjavur - 613403



PONNAIYAH RAMAJAYAM INSTITUTE OF SCIENCE & TECHNOLOGY (PRIST)

Declared as DEEMED TO BE UNIVERSITY
U/s 3 of UGC Act, 1956

**DEPARTMENT OF PHYSICS
CERTIFICATE COURSE ON INDUSTRY LINKED OPTICAL FIBER TECHNOLOGY
STUDENTS ATTENDANCE
Academic Year 2023-2024**

S. No	REG.NO	NAME OF THE STUDENT	JULY 2023							AUGUST 2023							SEPTEMBER 2023							OCTOBER 2023						
			17	20	22	25	27	31	1	3	5	8	12	17	18	22	24	26	29	1	5	7	9	12	14	16	18	21	23	26
1	2201PH10101	K. MOHAMMED AFFRESH	/	/	/	/	/	/	/	/	/	/	/	/	/	/	/	/	/	/	/	/	/	/	/	/	/	/	/	/
2	2201PH10102	A. ASWINKUMAR	/	/	/	/	/	/	/	/	/	/	/	/	/	/	/	/	/	/	/	/	/	/	/	/	/	/	/	/
3	2201PH10103	D. ASHOK	/	/	/	/	/	/	/	/	/	/	/	/	/	/	/	/	/	/	/	/	/	/	/	/	/	/	/	/
4	2201PH10104	M. BALAMURUGAN	/	/	/	/	/	/	/	/	/	/	/	/	/	/	/	/	/	/	/	/	/	/	/	/	/	/	/	/
5	2201PH10105	R. BIHARANI	/	/	/	/	/	/	/	/	/	/	/	/	/	/	/	/	/	/	/	/	/	/	/	/	/	/	/	/
6	2201PH10106	K. BHARSHINI	/	/	/	/	/	/	/	/	/	/	/	/	/	/	/	/	/	/	/	/	/	/	/	/	/	/	/	/
7	2201PH10107	R. KANNAN	/	/	/	/	/	/	/	/	/	/	/	/	/	/	/	/	/	/	/	/	/	/	/	/	/	/	/	/
8	2201PH10108	FD. KARTHI	/	/	/	/	/	/	/	/	/	/	/	/	/	/	/	/	/	/	/	/	/	/	/	/	/	/	/	/
9	2201PH10109	C. KANNATHASAN	/	/	/	/	/	/	/	/	/	/	/	/	/	/	/	/	/	/	/	/	/	/	/	/	/	/	/	/
10	2201PH10110	MLIO	/	/	/	/	/	/	/	/	/	/	/	/	/	/	/	/	/	/	/	/	/	/	/	/	/	/	/	/

The Head, Department of Physics,
PRIST Deemed to be University,
Vallam, Thanjavur-613403.
Tamilnadu, India

DEAN
School of Arts & Science
Ponnaiyah Ramajayam Institute of
Science & Technology (PRIST)
Deemed to be University

30.	2201PH10130	EAKALYA	/	/	/	/	/	/	/	/	/	/	/	/	/	/	/	/	/	/	/	/	/	/	/	/	/	/	/	/	/	/	/	/	/	/	/	/	/	/
Staff Signature																																								

The Head, Department of Physics,
PRIST Deemed to be University,
Vallam, Thanjavur-613403.
Tamilnadu, India.

DEAN
School of Arts & Science
Ponnaiyah Ramajeyam Institute of
Science & Technology (PRIST)
Deemed to be University
Vallam, Thanjavur - 613403.



PONNAIYAH RAMAJAYAM INSTITUTE OF SCIENCE & TECHNOLOGY (PRIST)

Declared as DEEMED-TO-BE-UNIVERSITY
 U/s 3 of UGC Act, 1956

DEPARTMENT OF PHYSICS
CERTIFICATE COURSE ON INSTALLATION AND MAINTENANCE OF DIGITAL CIRCUITS
STUDENTS ATTENDANCE
Academic Year 2023-2024

S. No	REG.NO	NAME OF THE STUDENT	JULY 2023							AUGUST 2023							SEPTEMBER 2023							OCTOBER 2023						
			17	20	22	25	27	31	1	3	5	8	12	17	18	22	24	26	29	1	5	7	9		12	14	16	18	21	23
1	2201PH10131	S. ASWINI	/	/	a	/	/	/	/	/	/	/	/	/	/	/	/	/	/	/	/	/	/	/	/	/	/	/	/	/
2	2201PH10132	S. COMATHI	/	/	/	/	/	/	/	/	a	/	/	/	/	/	/	/	/	/	/	/	/	/	/	/	/	/	/	/
3	2201PH10133	G.MATHUMITHA	/	/	/	/	/	/	/	/	/	/	/	/	/	/	/	/	/	/	/	/	/	/	/	/	/	/	/	/
4	2201PH10134	A.DURGA	/	/	/	/	/	/	/	a	/	/	/	/	/	/	/	/	/	/	/	/	/	/	/	/	/	/	/	/
5	2201PH10135	C.ELAVARAI	/	/	/	/	/	/	/	/	/	/	/	/	/	/	/	/	/	/	/	/	/	/	/	/	/	/	/	/
6	2201PH10136	S.SAMIYAPPAN	/	/	/	/	/	/	/	/	/	/	/	/	/	/	/	/	/	/	/	/	/	/	/	/	/	/	/	/
7	2201PH10137	K.VIGNESH	/	/	/	/	/	/	/	/	/	/	/	a	/	/	/	/	/	/	/	a	/	/	/	/	/	/	/	/
8	2201PH10138	M.VIGNESH	/	/	/	/	a	/	/	/	/	/	/	/	/	a	/	/	/	/	/	a	/	/	/	/	/	/	/	/
9	2201PH10139	G.VINITH	/	/	/	/	/	/	/	/	/	/	/	/	/	/	/	/	/	/	/	/	/	/	/	/	/	/	/	/
10	2201PH10140	B.NAGESWARAI	/	/	/	/	/	/	/	/	/	/	/	/	/	/	/	/	/	/	/	/	/	/	/	/	/	/	/	/
11	2201PH10141	S.VINOTH	/	/	/	/	/	/	/	/	/	/	/	/	/	/	/	/	/	/	/	/	/	/	/	/	/	/	/	/

The Head, Department of Physics,
 PRIST Deemed to be University,
 Vailam, Thanjavur-613403,
 Tamilnadu, India

(Signature)

School of Arts & Science
 Ponnaiyah Ramajayam Institute of
 Science & Technology (PRIST)
 Deemed to be University
 Vailam, Thanjavur - 613403

12.	2201PH10142	A. NAVANTH A	/	/	/	/	/	a	/	/	/	/	/	/	/	/	/	/	/	/	/	/	/	/	/	/	/	/	/	/	/
13.	2201PH10143	G. PAVITHRA	/	a	/	/	/	/	/	/	/	/	/	/	/	/	/	/	/	/	/	a	/	/	/	/	/	/	/	/	/
14.	2201PH10144	T. VENUGOPA L	/	/	/	/	/	/	/	/	/	/	/	/	/	/	/	/	/	/	/	/	/	/	/	/	/	/	/	/	/
15.	2201PH10145	K. VIYASH	/	/	/	/	a	/	/	/	/	/	/	/	/	/	/	/	/	/	/	/	/	/	/	/	/	/	/	/	/
16.	2201PH10146	J. VIKRAMAN	/	/	/	a	/	/	/	/	/	/	/	/	/	/	/	/	/	/	/	/	a	/	/	/	/	/	/	/	/
17.	2201PH10147	R. PAVIMANI	/	/	/	/	/	/	/	/	/	/	/	/	/	/	/	/	/	/	/	/	/	/	/	/	/	/	/	/	/
18.	2201PH10148	S. VEJAYAN	a	/	/	/	/	/	/	/	/	/	/	/	/	/	/	/	/	/	/	/	/	/	/	/	/	/	/	/	/
19.	2201PH10149	B. PARANIOT HI	/	/	/	/	/	/	/	/	/	/	/	/	/	/	/	/	/	/	/	/	/	/	/	/	/	/	/	/	/
20.	2101PH10131	S. SEENAZ FARHANA	/	/	/	/	/	/	/	/	/	/	/	/	/	/	/	/	/	/	/	a	/	/	/	/	/	/	/	/	/
21.	2101PH10132	S. BACKIYAL AKSMI	/	/	/	/	/	/	/	/	/	/	/	/	/	/	/	/	/	/	/	/	/	/	/	/	/	/	/	/	/
22.	2101PH10133	G. BALASUN DARI	/	/	/	/	/	/	/	/	/	/	/	/	/	/	/	/	/	/	/	/	/	/	/	/	/	/	/	/	/
23.	2101PH10134	A. DURGA	/	/	/	/	/	/	/	/	/	/	/	/	/	/	/	/	/	/	/	/	/	/	/	/	/	/	/	/	/
24.	2101PH10135	C. SUBBULA KSHMI	/	/	/	/	/	/	/	/	/	/	/	/	/	/	/	/	/	/	/	/	/	/	/	/	/	/	/	/	/
25.	2101PH10136	S. SUBASHI	/	/	/	/	/	/	/	/	/	/	/	/	/	/	/	/	/	/	/	/	/	/	/	/	/	/	/	/	/
26.	2101PH10137	K. HARISH	/	/	/	/	/	/	/	/	/	/	/	/	/	/	/	/	/	/	/	/	/	/	/	/	/	/	/	/	/
27.	2101PH10138	M. MADHAN	/	/	/	/	/	/	/	/	/	/	/	/	/	/	/	/	/	/	/	/	/	/	/	/	/	/	/	/	/
28.	2101PH10139	G. BALA	/	/	/	/	/	/	/	/	/	/	/	/	/	/	/	/	/	/	/	/	/	/	/	/	/	/	/	/	/
29.	2101PH10140	B. SUBBULAK SHMI	/	a	/	/	/	/	/	/	/	/	/	/	/	/	/	/	/	/	/	/	/	/	/	/	/	/	/	/	/
30.	2101PH10141	S. SIVA	/	/	/	/	/	/	/	/	/	/	/	/	/	/	/	/	/	/	/	/	/	/	/	/	/	/	/	/	/
31.	2101PH10142	A. MALAR	/	/	/	/	/	/	/	/	/	/	/	/	/	/	/	/	/	/	/	/	/	/	/	/	/	/	/	/	/

The Head, Department of Physics,
 PRIST Deemed to be University,
 Vallam, Thanjavur-613403.
 Tamilnadu, India.

DRAN
 School of Arts & Science
 Ponnaiyah Ramajayam Institute of
 Science & Technology (PRIST)
 Deemed to be University
 Vallam, Thanjavur - 613 403.

32.	2101PH10143	G. KAVYA	/	/	/	/	/	/	/	/	/	/	/	/	/	/	/	/	/	/	/	/	/	/	/	/	/	/	/	/	/	/	/				
33.	2101PH10144	T. VENUGOPAL	/	/	/	/	/	/	/	/	/	/	/	/	/	/	/	/	/	/	/	/	/	/	/	/	/	/	/	/	/	/					
34.	2101PH10145	K. MATHAVAN	/	/	/	/	/	/	/	/	/	/	/	/	/	/	/	/	/	/	/	/	/	/	/	/	/	/	/	/	/	/					
35.	2101PH10146	J. MANIKANDAN	/	/	/	/	/	/	/	/	/	/	/	/	/	/	/	/	/	/	/	/	/	/	/	/	/	/	/	/	/	/					
Staff Signature																																					

The Head, Department of Physics,
PRIST Deemed to be University,
Vallam, Thanjavur-613403,
Tamilnadu, India.



DEAN
School of Arts & Science
Ponnalyah Ramajayam Institute of
Science & Technology (PRIST)
Deemed to be University,
Vallam, Thanjavur-613403.



**PONNAIYAH RAMAJAYAM INSTITUTE OF
SCIENCE & TECHNOLOGY (PRIST)**

Declared as DEEMED-TO-BE-UNIVERSITY
U/s 3 of UGC Act, 1956

**DEPARTMENT OF PHYSICS
CERTIFICATE COURSE ON REGULATED POWER SUPPLY
STUDENTS ATTENDANCE
Academic Year 2023-2024**

S. No	REG.NO	NAME OF THE STUDENT	JULY 2023						AUGUST 2023									SEPTEMBER 2023									1			
			17	20	22	25	27	31	1	3	5	8	12	17	18	22	24	26	29	1	5	7	9	12	14	16	18	21	23	26
1.	2301PH10201	Barshini K.T.	/	/	/	a	/	/	/	/	/	/	/	/	/	/	/	/	/	/	/	/	/	/	/	/	/	/	/	/
2.	2301PH10202	Siddarth B	/	/	/	/	/	/	/	/	/	/	/	/	/	/	/	/	/	/	/	/	/	/	/	/	/	/	/	/
3.	2301PH10203	Prashanth K	/	/	/	/	/	/	/	/	/	/	/	/	/	/	/	/	/	/	/	/	/	/	/	/	/	/	/	/
4.	2301PH10204	Priyadarshini K.	/	/	/	/	/	/	/	/	/	/	/	/	/	/	/	/	/	/	/	/	/	/	/	/	/	/	/	/
5.	2301PH10205	Anna Raja Rubi A	/	/	/	/	/	/	/	/	/	/	/	/	/	/	/	/	/	/	/	/	/	/	/	/	/	/	/	/
6.	2301PH10206	Yamuna M	/	/	/	/	/	/	/	/	/	/	/	/	/	/	/	/	/	/	/	/	/	/	/	/	/	/	/	/
7.	2301PH10207	J. Karthikeyan	/	/	/	/	/	/	/	/	/	/	/	/	/	/	/	/	/	/	/	/	/	/	/	/	/	/	/	/
8.	2301PH10208	C. Anitha	/	/	/	/	/	/	/	/	/	/	/	/	/	/	/	/	/	/	/	/	/	/	/	/	/	/	/	/
9.	2301PH10209	B. Praveen Bana	/	/	/	/	/	/	/	/	/	/	/	/	/	/	/	/	/	/	/	/	/	/	/	/	/	/	/	/
10.	2301PH10210	P. Priya darshini	/	/	/	/	/	/	/	/	/	/	/	/	/	/	/	/	/	/	/	/	/	/	/	/	/	/	/	/

The Head, Department of Physics,
PRIST Deemed to be University,
Vallam, Thanjavur-613403,
Tamilnadu, India.

DEAN
School of Arts & Science
Ponnaiyah Ramajayam Institute of
Science & Technology (PRIST)
Deemed to be University
Vallam, Thanjavur - 613 403.

11.	2301PH10211	B. Dhanush Isharathi	/	/	/	/	/	/	/	/	/	/	/	/	/	/	/	/	/	/	/	/	/	/	/	/	/	
12.	2301PH10212	D. Sugarcha Murthy	/	/	/	/	/	/	/	/	/	/	/	/	/	/	/	/	/	/	/	/	/	/	/	/	/	
13.	2301PH10213	S. Kowsic	/	/	/	/	/	/	/	/	/	/	/	/	/	/	/	/	/	/	/	/	/	/	/	/	/	
14.	2301PH10214	S. Gayathri	/	/	/	/	/	/	/	/	/	/	/	/	/	/	/	/	/	/	/	/	/	/	/	/	/	
15.	2301PH10215	K. Vijaya siva Nivashini	/	/	/	/	/	/	/	/	/	/	/	/	/	/	/	/	/	/	/	/	/	/	/	/	/	
16.	2301PH10216	C. Vjun Raj	/	/	/	x	/	/	/	/	/	/	/	/	/	/	/	/	/	/	/	/	/	/	/	/	/	
17.	2301PH10217	S.M. Varthini	/	/	/	/	/	/	/	/	/	/	/	/	/	/	/	/	/	/	/	/	/	/	/	/	/	
18.	2301PH10218	Kannan L.	/	/	/	/	/	/	/	/	/	/	/	/	/	/	/	/	/	x	/	/	/	/	/	/	/	
19.	2301PH10219	Mani S.	/	/	/	/	/	/	/	/	/	/	/	/	/	/	/	/	/	/	/	/	/	x	/	/	/	
20.	2301PH10220	Ramare T.	/	/	/	/	/	/	/	/	/	/	/	/	/	/	/	/	/	/	/	/	/	/	/	/	/	
21.	2301PH10221	Sivanesan V.	/	/	/	/	/	/	/	/	/	/	/	/	/	/	/	/	/	/	/	/	/	/	/	/	/	
22.	2301PH10222	Saravanan R.	/	/	/	x	/	/	/	/	/	/	/	/	/	/	/	/	/	/	/	/	/	/	/	/	/	
Staff Signature																												

 The Head, Department of Physics,
 PRIST Deemed to be University,
 Vallam, Thanjavur-613403,
 Tamilnadu, India.

 DEAN
 School of Arts & Science
 Ponnaiyah Ramajayam Institute of
 Science & Technology (PRIST),
 Deemed to be University,
 Vallam, Thanjavur - 613403.



PONNAIYAH RAMAJAYAM INSTITUTE OF SCIENCE & TECHNOLOGY (PRIST)

Declared as DEEMED TO BE UNIVERSITY
U/s 3 of UGC Act, 1956

**DEPARTMENT OF PHYSICS
CERTIFICATE COURSE ON COSMOLOGY AND STRUCTURE FORMATION
STUDENTS ATTENDANCE
Academic Year 2023-2024**

S. No	REG.NO	NAME OF THE STUDENT	JULY 2023						AUGUST 2023									SEPTEMBER 2023									OCTOBER 2023			
			17	20	22	25	27	31	1	3	5	8	12	17	18	22	24	26	29	1	5	7	9	12	14	16		18	21	23
1	2301PH10223	Saravanan V	/	/	/	/	/	a	/	/	/	/	/	/	/	/	/	/	/	/	/	/	/	/	/	/	/	/	/	/
2	2301PH10224	Sasi R	/	/	/	/	/	a	/	/	/	/	/	/	/	/	/	/	/	/	/	/	/	/	/	/	/	/	/	/
3	2301PH10225	Kalanithi K	/	/	/	a	/	/	/	/	/	/	/	/	/	/	/	/	/	/	/	/	/	/	/	/	/	/	/	/
4	2301PH10226	Swaminathan M	a	/	/	/	/	/	/	/	/	/	/	/	/	/	/	/	/	/	/	/	/	/	/	/	/	/	/	/
5	2301PH10227	Arundha selvan T	/	/	/	a	/	/	/	/	/	/	/	/	/	/	/	/	/	/	/	/	/	/	/	/	/	/	/	/
6	2301PH10228	Kaliyaperuma IR	/	/	/	/	/	/	a	/	/	/	/	/	/	/	/	/	/	/	/	/	/	/	/	/	/	/	/	/
7	2301PH10229	Senthani selvai	/	/	/	/	/	/	/	/	/	/	/	/	/	/	/	/	/	/	/	/	/	/	/	/	/	/	/	/
8	2301PH10230	Arul Mari A	/	/	/	/	/	/	/	/	/	/	/	/	/	/	/	/	/	/	/	/	/	/	/	/	/	/	/	/
9	2301PH10231	Arnachalam A	/	/	/	/	/	/	/	/	/	/	/	/	/	/	/	/	/	/	/	/	/	/	/	/	/	/	/	/
10	2301PH10232	Manikandan A	/	/	a	/	/	/	/	/	/	/	/	/	/	/	/	/	/	/	/	/	/	/	/	/	/	/	/	/
11	2301PH10233	Sanjeevraja K	/	/	/	/	/	/	/	/	/	/	/	/	/	/	/	/	/	/	/	/	/	/	/	/	/	/	/	/

The Head, Department of Physics,
PRIST - Deemed to be University,
V. V. Thiruvur - 613 403,
Tamil Nadu, India.

DEAN,
School of Arts & Science
Ponnaiyah Ramajayam Institute of
Science & Technology (PRIST)
Deemed to be University
V. V. Thiruvur - 613 403.

12	2301PH10234	Thyanthi V	/	/	/	/	/	/	/	/	/	/	/	/	/	/	/	/	/	/	/	/	/	/	/	/	/	/	/
13	2301PH10235	Vassantha Kumar V	/	/	/	/	/	/	/	/	/	/	/	/	/	/	/	/	/	/	/	/	/	/	/	/	/	/	/
14	2301PH10236	Krubanathi K	/	/	/	/	/	/	/	/	/	/	/	/	/	/	/	/	/	/	/	/	/	/	/	/	/	/	/
15	2301PH10237	Vetrivel M	/	/	/	/	/	/	/	/	/	/	/	/	/	/	/	/	/	/	/	/	/	/	/	/	/	/	/
16	2301PH10238	Rajaji K	/	/	/	/	/	/	/	/	/	/	/	/	/	/	/	/	/	/	/	/	/	/	/	/	/	/	/
17	2301PH10239	Sandru S	/	/	/	/	/	/	/	/	/	/	/	/	/	/	/	/	/	/	/	/	/	/	/	/	/	/	/
18	2301PH10240	Imayavaramb an M	/	/	/	/	/	/	/	/	/	/	/	/	/	/	/	/	/	/	/	/	/	/	/	/	/	/	/
19	2301PH10241	Amulraj P	/	/	/	/	/	/	/	/	/	/	/	/	/	/	/	/	/	/	/	/	/	/	/	/	/	/	/
20	2301PH10242	Ajithkumar	/	/	/	/	/	/	/	/	/	/	/	/	/	/	/	/	/	/	/	/	/	/	/	/	/	/	/
21	2301PH10243	Kamal Raj	/	/	/	/	/	/	/	/	/	/	/	/	/	/	/	/	/	/	/	/	/	/	/	/	/	/	/
22	2301PH10244	Sanmugasund aram P	/	/	/	/	/	/	/	/	/	/	/	/	/	/	/	/	/	/	/	/	/	/	/	/	/	/	/
23	2301PH10245	Senthuran C	/	/	/	/	/	/	/	/	/	/	/	/	/	/	/	/	/	/	/	/	/	/	/	/	/	/	/
24	2301PH10246	Uthayakumar K	/	/	/	/	/	/	/	/	/	/	/	/	/	/	/	/	/	/	/	/	/	/	/	/	/	/	/
Staff Signature			/	/	/	/	/	/	/	/	/	/	/	/	/	/	/	/	/	/	/	/	/	/	/	/	/	/	/

 The Head, Department of Physics,
 PRIST Deemed to be University,
 Vallam, Thanjavur-613403,
 Tamilnadu, India.

 DEAN
 School of Arts & Science
 Ponnalyah Ramajayam Institute of
 Science & Technology (PRIST)
 Deemed to be University
 Vallam, Thanjavur - 613 403.



PONNAIYAH RAMAJAYAM INSTITUTE OF SCIENCE & TECHNOLOGY (PRIST)

Declared as DEEMED-TO-BE-UNIVERSITY
U/s 3 of UGC Act, 1956

DEPARTMENT OF PHYSICS
CERTIFICATE COURSE ON INSTALLATION AND MAINTENANCE OF SOLAR PHOTOVOLTAIC SYSTEMS
STUDENTS ATTENDANCE
Academic Year 2023-2024

S. No	REG.NO	NAME OF THE STUDENT	FEBRUARY 2024												MARCH 2024								APRIL 2024								
			2	6	8	10	13	15	17	20	22	24	27	6	8	11	13	15	18	20	22	23	25	27	28	3	5	8	11	12	16
1	2201PH20101	V.VIMAL	/	/	/	/	/	/	/	/	/	/	/	/	/	/	/	/	/	/	/	/	/	/	/	/	/	/	/	/	/
2	2201PH20102	D.VITHYAS AHAR	/	/	/	/	/	/	/	/	/	/	/	/	/	/	/	/	/	/	/	/	/	/	/	/	/	/	/	/	/
3	2201PH20103	S. YAGAVARA YAN	/	x	/	/	/	/	/	/	/	/	/	/	/	/	/	/	/	/	/	/	/	/	/	/	/	/	/	/	/
4	2201PH20104	A. YUVAN	/	/	/	/	/	/	/	/	/	/	/	/	/	/	/	/	/	/	/	/	/	/	/	/	/	/	/	/	/
5	2201PH20105	H. YUVARAJ	/	/	/	/	/	/	/	/	/	/	/	/	/	/	/	/	/	/	/	/	/	/	/	/	/	/	/	/	/
6	2201PH20106	M. YOGIRABU	/	/	/	/	/	/	/	/	/	/	/	/	/	/	/	/	/	/	/	/	/	/	/	/	/	/	/	/	/
7	2201PH20107	R.YUNESH AHAMED	/	/	/	/	/	/	/	/	/	/	/	/	/	/	/	/	/	/	/	/	/	/	/	/	/	/	/	/	/
8	2201PH20108	R.YUSUF PATHAN	/	/	/	/	/	/	/	/	/	/	/	/	/	/	/	/	/	/	/	/	/	/	/	/	/	/	/	/	/
9	2201PH20109	A.YUSUF SYAM	/	/	/	/	/	/	/	/	/	/	/	/	/	/	/	/	/	/	/	/	/	/	/	/	/	/	/	/	/

The Head, Department of Physics,
PRIST Deemed to be University,
Vallam, Thanjavur-613403.
Tamilnadu, India.

DEAN
School of Arts & Science
Ponnaiyah Ramajayam Institute of
Science & Technology (PRIST)
Deemed to be University
Vallam, Thanjavur - 613 403.

10.	2201PH20110	R. YUSUF SIRAJ	/	/	/	/	/	/	/	/	/	/	/	/	/	/	/	/	/	/	/	/	/	/	/	/	/	/	/	/	/	/	/	/	/	/	/	/
11.	2201PH20111	S. YUSUF VIYAS	/	/	/	/	2	/	/	/	/	/	/	/	/	/	/	/	/	/	/	/	/	/	/	/	/	/	/	/	/	/	/	/	/	/	/	/
12.	2201PH20112	S. YUSUF YUVAS	/	/	/	/	/	/	/	/	/	/	/	/	/	/	/	/	/	/	/	/	/	/	/	/	/	/	/	/	/	/	/	/	/	/	/	/
13.	2201PH20113	V. SANTHASE ELAN	/	/	/	/	/	/	/	/	/	/	2	/	/	/	/	/	/	/	/	/	/	/	/	/	/	/	/	/	/	/	/	/	/	/	/	/
14.	2201PH20114	VJOHN ABLE	/	/	/	/	/	/	/	/	/	/	/	/	/	/	/	/	/	/	/	/	/	/	/	/	/	/	/	/	/	/	/	/	/	/	/	/
15.	2201PH20115	D.AKASATIN	/	/	2	/	/	/	/	/	/	/	/	/	/	/	/	/	/	/	/	/	/	/	/	/	/	/	/	/	/	/	/	/	2	/	/	/
16.	2201PH20116	T. CHINNARAJA	/	/	/	/	/	/	/	/	/	/	/	/	/	/	/	/	/	/	/	/	/	/	/	/	/	/	/	/	/	/	/	/	/	/	/	/
17.	2201PH20117	I.DINESH	/	/	/	/	/	/	/	/	/	/	/	/	/	/	/	/	/	/	/	/	/	/	/	/	/	/	/	/	/	/	/	/	/	/	/	/
18.	2201PH20118	E.RAJASH	/	/	/	/	/	/	/	/	/	/	/	/	/	/	/	/	/	/	/	/	/	/	/	/	/	/	/	/	/	/	/	/	/	/	/	/
19.	2201PH20119	M.VELLADURAJ	/	/	/	/	/	/	/	/	/	/	/	/	/	/	/	/	/	/	/	/	/	/	/	/	/	/	/	/	/	/	/	/	/	/	/	/
20.	2201PH20120	R.PUGALENTHI	/	/	/	/	/	/	/	/	/	/	/	/	/	/	/	/	/	/	/	/	/	/	/	/	/	/	/	/	/	/	/	/	/	/	/	/
21.	2201PH20123	S.A. SATHISH KANNAN	/	/	/	/	/	/	/	/	/	/	/	/	/	/	/	/	/	/	/	/	/	/	/	/	/	/	/	/	/	/	/	/	/	/	/	/
22.	2201PH20124	K. AKLANNITHI	/	2	/	/	/	/	/	/	2	/	/	/	/	/	/	/	/	/	/	/	/	/	/	/	/	/	/	/	/	/	/	/	/	/	/	/
Staff Signature																																						

The Head, Department of Physics,
PRIST Deemed to be University,
Vallam, Thanjavur-613403.
Tamilnadu, India.

DEAN
School of Arts & Science
Ponnaiyah Ramajayam Institute of
Science & Technology (PRIST)
Deemed to be University
Vallam, Thanjavur - 613 403.



**PONNAIYAH RAMAJAYAM INSTITUTE OF
SCIENCE & TECHNOLOGY (PRIST)**

Declared as DEEMED-TO-BE-UNIVERSITY
U/s 3 of UGC Act, 1956

**DEPARTMENT OF PHYSICS
CERTIFICATE COURSE ON MICROCONTROLLER
STUDENTS ATTENDANCE
Academic Year 2023-2024**

S. No	REG.NO	NAME OF THE STUDENT	FEBRUARY 2024												MARCH 2024								APRIL 2024										
			2	6	8	10	13	15	17	20	22	24	27	6	8	11	13	15	18	20	22	23	25	27	28	3	5	8	11	12	16	18	
1	2101PH10101	S.Vishwanathan	/	/	/	/	/	/	/	/	/	/	/	/	/	/	/	/	/	/	/	/	/	/	/	/	/	/	/	/	/	/	/
2	2101PH10102	S.Aravindh Kumar	/	/	/	/	/	/	/	/	/	/	/	/	/	/	/	/	/	/	/	/	/	/	/	/	/	/	/	/	/	/	/
3	2101PH10103	L.Venkatesh	/	/	/	/	/	/	/	/	/	/	/	/	/	/	/	/	/	/	/	/	/	/	/	/	/	/	/	/	/	/	/
4	2101PH10104	M.Mugil	/	/	/	/	/	/	/	/	/	/	/	/	/	/	/	/	/	/	/	/	/	/	/	/	/	/	/	/	/	/	/
5	2101PH10105	S.Santhru	/	/	/	/	/	/	/	/	/	/	/	/	/	/	/	/	/	/	/	/	/	/	/	/	/	/	/	/	/	/	/
6	2101PH10106	R.Esakk Raja	/	/	a	/	/	/	/	/	/	/	/	/	/	/	/	/	/	/	/	/	/	/	/	/	/	/	/	/	/	/	/
7	2101PH10107	B.Muthu man	/	/	/	/	/	/	/	/	/	/	/	/	/	/	/	/	/	/	/	/	/	/	/	/	/	/	/	/	/	/	/
8	2101PH10108	V.Balaji	/	/	/	/	/	/	/	/	/	/	/	/	/	/	/	/	/	/	/	/	/	/	/	/	/	/	/	/	/	/	/
9	2101PH10109	A.Suriya	/	/	/	/	/	/	/	/	/	/	/	/	/	/	/	/	/	/	/	/	/	/	/	/	/	/	/	/	/	/	/
10	2101PH10110	D.Sugan	a	/	/	/	/	/	/	/	/	/	/	/	/	/	/	/	/	/	/	/	/	/	/	/	/	/	/	/	/	/	/
11	2101PH10111	S.Kalai Vannan	/	/	/	/	/	/	/	/	/	/	/	/	/	/	/	/	/	/	/	/	/	/	/	/	/	/	/	/	/	/	/

The Head, Department of Physics,
PRIST Deemed to be University,
Vallam, Thanjavur-613403,
Tamilnadu, India.

DEAN
School of Arts & Science
Ponnaiyah Ramajayam Institute of
Science & Technology (PRIST)
Deemed to be University,
Vallam, Thanjavur - 613 403.



PONNAIYAH RAMAJAYAM INSTITUTE OF
SCIENCE & TECHNOLOGY (PRIST)

Declared as DEEMED TO BE UNIVERSITY
U/s 3 of UGC Act, 1956

SCHOOL OF ARTS AND SCIENCE
DEPARTMENT OF PHYSICS
VALUE ADDED COURSE

CERTIFICATE OF APPRECIATION

This is to certify that Mr./~~Ms.~~ Velmurugan T, Reg. No. 2301PH10301 has completed the Value Added Diploma course on Crystal Growth Analysis from July 2023 to March 2023 during the academic year 2023-24.

Course Coordinator

HOD

Dean



PONNAIYAH RAMAJAYAM INSTITUTE OF
SCIENCE & TECHNOLOGY (PRIST)

Declared as DEEMED TO-BE UNIVERSITY
U/s 3 of UGC Act, 1956

SCHOOL OF ARTS AND SCIENCE
DEPARTMENT OF PHYSICS
VALUE ADDED COURSE
CERTIFICATE OF APPRECIATION

This is to certify that ~~Mr.~~/Ms. J.ANANTHI, Reg. No. 2201PH10129 has completed the Value Added Certificate course on Industry Linked Optical Fiber Technology from July 2023 to September 2023 during the academic year 2023-24.

R. Murthy

Course Coordinator

S. Subba

HOD

S. Sanyal

Dean



PONNAIYAH RAMAJAYAM INSTITUTE OF
SCIENCE & TECHNOLOGY (PRIST)

Declared as DEEMED-TO-BE-UNIVERSITY
U/s 5 of UGC Act, 1956

SCHOOL OF ARTS AND SCIENCE
DEPARTMENT OF PHYSICS
VALUE ADDED COURSE

CERTIFICATE OF APPRECIATION

This is to certify that Mr./Ms. S. SIVA, Reg. No. 2101PH10141 has completed the Value Added Certificate course on Installation and maintenance of digital circuits from July 2023 to September 2023 during the academic year 2023-24.

Course Coordinator

HOD

Dean



PONNAIYAH RAMAJAYAM INSTITUTE OF
SCIENCE & TECHNOLOGY (PRIST)

Declared as DEEMED-TO-BE-UNIVERSITY
Via 3 of UGC Act, 1956

SCHOOL OF ARTS AND SCIENCE
DEPARTMENT OF PHYSICS
VALUE ADDED COURSE

CERTIFICATE OF APPRECIATION

This is to certify that Mr./Ms. V. Sivanesan, Reg. No. 2301PH10221 has completed the Value Added Certificate course on regulated power supply from July 2023 to September 2023 during the academic year 2023-24.

K. Vinath

Course Coordinator

HOD

Dean



PONNAIYAH RAMAJAYAM INSTITUTE OF
SCIENCE & TECHNOLOGY (PRIST)

Declared as DEEMED TO BE UNIVERSITY
U/s 3 of UGC Act, 1956

SCHOOL OF ARTS AND SCIENCE
DEPARTMENT OF PHYSICS
VALUE ADDED COURSE
CERTIFICATE OF APPRECIATION

This is to certify that ~~Mr.~~/Ms. Sasi R, Reg. No. 2301PH10224 has completed the Value Added Certificate course on cosmology and structure formation from July 2023 to September 2023 during the academic year 2023-24.

C. Thenmozhi

Course Coordinator

S. S. S.

HOD

[Signature]

Dean



PONNAIYAH RAMAJAYAM INSTITUTE OF
SCIENCE & TECHNOLOGY (PRIST)

Declared as DEEMED-TO-BE UNIVERSITY
Via 3 of UGC Act, 1956

SCHOOL OF ARTS AND SCIENCE
DEPARTMENT OF PHYSICS
VALUE ADDED COURSE
CERTIFICATE OF APPRECIATION

This is to certify that Mr./Ms. S.A. SATHISH KANNAN, Reg. No.
2201PH20123 has completed the Value Added Certificate course on
Installation and Maintenance of Solar Photovoltaic Systems from February
2024 to April 2024 during the academic year 2023-24.

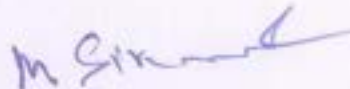
Course Coordinator

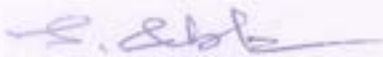
HOD

Dean



PONNAIYAH RAMAJAYAM INSTITUTE OF
SCIENCE & TECHNOLOGY (PRIST)

Declared as DEEMED-TO-BE-UNIVERSITY
U/s 3 of UGC Act, 1956

SCHOOL OF ARTS AND SCIENCE
DEPARTMENT OF PHYSICS
VALUE ADDED COURSE

CERTIFICATE OF APPRECIATION

This is to certify that Mr./Ms. S.Santhru, Reg. No. 2101PH10105 has completed the Value Added Certificate course on Microcontroller from February 2024 to April 2024 during the academic year 2023-24.

D. Nandhoni

Course Coordinator

[Signature]

HOD

[Signature]

Dean



PONNAIYAH RAMAJAYAM INSTITUTE OF SCIENCE & TECHNOLOGY (PRIST)

Declared as DEEMED-TO-BE-UNIVERSITY
U/s 3 of UGC Act, 1956

SCHOOL OF AGRICULTURE

CIRCULAR

Date: 16.10.2023

This is to inform B.Sc., (HONS.) Agriculture students that the value-added course programme classes for the academic year 2023-2024 will be commenced from 30.10.2023. Hence, requesting all the registered students to attend the classes without fail.

DEAN

SCHOOL OF AGRICULTURE

DEAN

School of Agriculture
Ponnaiyah Ramajayam Institute of
Science & Technology (PRIST)
Institution Deemed to be University
U/s 3 of the UGC Act, 1956
KAVUR - 619 400, TAMIL NADU

Copy to,

All teaching staff members

Students

Co - Ordinator



PONNAIYAH RAMAJAYAM INSTITUTE OF SCIENCE & TECHNOLOGY (PRIST)

Declared as DEEMED-TO-BE-UNIVERSITY
U/s 3 of UGC Act, 1956

SCHOOL OF AGRICULTURE



INFORMATION BROCHURE

VALUE ADDED COURSE

B. Sc. (HONS.) Agriculture

Certificate course on

"KITCHEN GARDEN"

[Signature]
HEAD
School of Agriculture
Ponnaiyah Ramajayam Institute of
Science & Technology (PRIST)
Institution Deemed to be University
U/s 3 of the UGC Act, 1956
MANJAVUR - 613 403, TAMIL NADU

[Signature]
DEAN
School of Agriculture
Ponnaiyah Ramajayam Institute of
Science & Technology (PRIST)
Institution Deemed to be University
U/s 3 of the UGC Act, 1956
MANJAVUR - 613 403, TAMIL NADU

About the University

The Institute was founded in 1985 by Prof. P. Murugesan. It was initially known as the Institute of Computer Science and Technology. Murugesan founded the Institute to introduce computer education to the Thanjavur District. In 1988, the Institute received affiliation from Bharathidasan University to offer Postgraduate Diploma Programmes in Computer Applications.

Thereafter it expanded to include an Arts and Science College, College of Engineering and Technology, College of Education, Research Institution, and Polytechnic College.

In 2004, Ponnaiya Ramajayam College applied for NAAC assessment and accreditation and was awarded an "A" grade, thus making it the first "A" grade awarded college in the Bharathidasan University area. The college then submitted its proposal to the Ministry of Human Resource Development, Government of India for deemed university status.

On 4 January 2008, the Institute was conferred deemed university status based on the recommendations of the UGC Expert Committee, the Ministry of HRD, and the Government of India. The Institute also received approval from the Distance Education Council (DEC) and its B.Ed. course is approved by The National Council for Teacher Education (NCTE).

Currently, the Institute offers degrees in Medicine, Engineering, Arts & Science, Education, Pharmacy, Management, Agriculture and Technology, as well as Ph.D. programmes in some of these fields.

About the Department

The School of Agriculture under Ponnaiyah Ramajayam Institute of Science and Technology (PRIST) was established at Vallam, Thanjavur in the year 2016.

The agriculture is intended to impart high quality education so as to produce not just agricultural graduates but agro technocrats with practical and conceptual skills. With precise and deliberate course modules, which provides education, research and training along with first hand field experiences, the students would sure be transformed as skilled human resources.

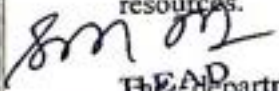
HEAD
Department of Agriculture
Ponnaiyah Ramajayam Institute of
Science & Technology (PRIST)
Affiliation Deemed to be University
11/5 3 of the UGC Act, 1956
THANJAVUR - 613 403, TAMIL NADU

DEAN
School of Agriculture
Ponnaiyah Ramajayam Institute of
Science & Technology (PRIST)
Affiliation Deemed to be University
11/5 3 of the UGC Act, 1956
THANJAVUR - 613 403, TAMIL NADU

Economics lab and Audio – Visual lab. All the laboratories are fully equipped with latest, modern and sophisticated equipment.

The Department has young as well as experienced and dynamic personalities as faculty, is involved in providing quality education at Undergraduate (UG) levels. The staffs are from various disciplines in Doctorate like Plant Pathology, Microbiology, Soil science, Plant Genetics and Veterinary. The staffs are from various disciplines in masters like Agricultural Entomology, Agronomy, Agricultural Extension, Horticulture and Economics. Many of the staff members are encouraged to pursue their higher studies and research works.

About the Course

Introduction and Overview

- Vegetable occupy an important place in our daily life particularly for vegetarians. Vegetables are the only source to increase not only the nutritive values of foods but also its palatability. For a balanced diet, an adult should have an intake of 85 g of fruits and 300 g of vegetables per day as per the dietary recommendation of nutrition specialists. But the present level of production of vegetables in our country can permit a per capita consumption of only 120 g of vegetables per day.
- However, people in India especially in the rural areas seldom eat vegetables due to the following reasons. Considering the above facts, we should plan to produce our own vegetable requirements in our backyards using the available fresh water as well as the kitchen and bathroom wastewater. This will not only facilitate prevention of stagnation unused water which will be hazardous to our health through environmental pollution, but can be useful for successful production of our own requirement of vegetables. Cultivation in a small area facilitates the methods of controlling pests and diseases through the removal of affected parts and non-use of chemicals. This is a safe practice, which does not cause toxic residues of pesticides in the vegetables produced

What Kitchen garden?

- Kitchen garden is the growing of fruits and vegetables at the backyard of house by using kitchen waste water.
- Otherwise called as Home garden or Nutrition garden or Kitchen gardening or Vegetable gardening

Benefits of Kitchen-garden

Supply fresh fruits and vegetables high in nutritive value.

Supply fruits and vegetables free from toxic chemicals.

Help to save expenditure on purchase of vegetables.

DEAN

School of Agriculture
Jinnaiyah Ramajayam Institute of
Science & Technology (PRIST)

Institution Deemed to be University
Act 3 of the UGC Act, 1956
TIRUVANANTHAPURAM : 613 403, TAMIL NADU

HEAD
School of Agriculture
Jinnaiyah Ramajayam Institute of
Science & Technology (PRIST)
Institution Deemed to be University
Act 3 of the UGC Act, 1956
TAMIL NADU

- Vegetables harvested from home garden taste better than those purchased from market.
- Effective utilization of kitchen waste water and kitchen waste materials. Exercise to the body and mind.

Learning outcomes of the course unit

- Gardeners fed their families first and then sell, barter or give away surplus garden foods. In certain contexts, however, income generation may become the primary objective of the home garden. In any case, it is counterproductive to impose the nutrition objective to the exclusion of the income generation objective, since in most contexts they are linked and compatible.
- The potential economic benefits of home gardening include the following
- Gardening gives dual benefits of food and income generation
- Garden provide fodder for household animals and supplies for other household needs (hand-crafts, fuel wood, furniture, baskets, etc.)

Eligibility: Any graduates / ongoing degree students shall be eligible for the admission to the course.

Duration of the Program: 45 hrs. Value added Certificate Course.

Lecture Hours: 4.30 p.m. to 5.30 p.m. (Monday to Saturday)

Mode of Examination: Written Exam and seminar

Award of Certificate: The candidate successfully qualifying the course shall be awarded a certificate to that effect in the appropriate form by School of Agriculture, PRIST Deemed to be University, Vallam, Thanjavur.

HEAD
 School of Agriculture
 Ponnaiyah Ramajayam Institute of
 Science & Technology (PRIST)
 Institution Deemed to be University
 U/s 3 of the UGC Act, 1956
 THANJAVUR - 613 403, TAMIL NADU

DEAN
 School of Agriculture
 Ponnaiyah Ramajayam Institute of
 Science & Technology (PRIST)
 Institution Deemed to be University
 U/s 3 of the UGC Act, 1956
 THANJAVUR - 613 403, TAMIL NADU



**PONNAIYAH RAMAJAYAM INSTITUTE OF
SCIENCE & TECHNOLOGY (PRIST)**

Declared as DEEMED-TO-BE-UNIVERSITY
U/s 3 of UGC Act, 1956

SCHOOL OF AGRICULTURE

CIRCULAR

Date: 05.2.2024

This is to inform B.Sc., (HONS.) Agriculture students that the value-added course programme classes for the academic year 2023-2024 will be commenced from 19.02.2024. Hence, requesting all the registered students to attend the classes without fail.

DEAN

SCHOOL OF AGRICULTURE

DEAN

**School of Agriculture
Ponnaiyah Ramajayam Institute of
Science & Technology (PRIST)
Institution Deemed to be University
U/s 3 of the UGC Act, 1956
NJAVUR - 613 403, TAMIL NADU**

Copy to,

All teaching staff members

Students

Co - Ordinator



PONNAIYAH RAMAJAYAM INSTITUTE OF SCIENCE & TECHNOLOGY (PRIST)

Declared as DEEMED-TO-BE-UNIVERSITY
U/s 3 of UGC Act, 1956

SCHOOL OF AGRICULTURE



INFORMATION BROCHURE

VALUE ADDED COURSE

B. Sc. (Hons.) Agriculture

Certificate course on

POST HARVEST TECHNOLOGY

to be
HEAD
School of Agriculture
Ponnaiyah Ramajayam Institute of
Science & Technology (PRIST)
Institution Deemed to be University
U/s 3 of the UGC Act, 1956
THANJAVUR - 613 403, TAMIL NADU

Verd
DEAN
School of Agriculture
Ponnaiyah Ramajayam Institute of
Science & Technology (PRIST)
Institution Deemed to be University
U/s 3 of the UGC Act, 1956
THANJAVUR - 613 403, TAMIL NADU.

About the University

The Institute was founded in 1985 by Prof. P. Murugesan. It was initially known as the Institute of Computer Science and Technology. Murugesan founded the Institute to introduce computer education to the Thanjavur District. In 1988, the Institute received affiliation from Bharathidasan University to offer Postgraduate Diploma Programmes in Computer Applications.

Thereafter it expanded to include an Arts and Science College, College of Engineering and Technology, College of Education, Research Institution, and Polytechnic College.

In 2004, Ponnaiya Ramajayam College applied for NAAC assessment and accreditation and was awarded an "A" grade, thus making it the first "A" grade awarded college in the Bharathidasan University area. The college then submitted its proposal to the Ministry of Human Resource Development, Government of India for deemed university status.

On 4 January 2008, the Institute was conferred deemed university status based on the recommendations of the UGC Expert Committee, the Ministry of HRD, and the Government of India. The Institute also received approval from the Distance Education Council (DEC) and its B.Ed. course is approved by The National Council for Teacher Education (NCTE).

Currently, the Institute offers degrees in Medicine, Engineering, Arts & Science, Education, Pharmacy, Management, Agriculture and Technology, as well as Ph.D. programmes in some of these fields.

About the Department

The School of Agriculture under Ponnaiyah Ramajayam Institute of Science and Technology (PRIST) was established at Vallam, Thanjavur in the year 2016.

The department has spacious laboratories such as Plant Pathology, Microbiology, Agricultural Entomology, Agricultural Botany and Genetics, Agronomy, Horticulture, Economics lab and Audio – Visual lab. All the laboratories are fully equipped with latest, modern and sophisticated equipment.

Handwritten signature
The Department has young as well as experienced and dynamic personalities as faculty, is involved in providing quality education at Undergraduate (UG) levels. The staff are from
DEAN
School of Agriculture
Ponnaiyah Ramajayam Institute of Science & Technology (PRIST)
Institution Deemed to be University
Act 2 of the UGC Act, 1956
THANJAVUR - 613 403, TAMIL NADU.

various disciplines in Doctorate like Plant Pathology, Microbiology, Soil science, Plant Genetics and Veterinary. The staffs are from various disciplines in masters like Agricultural Entomology, Agronomy, Agricultural Extension, Horticulture and Economics. Many of the staff members are encouraged to pursue their higher studies and research works.

About the Course

Introduction and Overview

Landscaping is the process of modifying the visible features of an area to enhance its aesthetic appeal, functionality, and overall value.

As you dive into the world of landscaping, there are a few key aspects to consider that will make your outdoor area truly shine. First of all, it's important to think about the design of your landscape.

What is post-harvest technology?

Post-harvest technology is the application of scientific and engineering principles to the handling, storage, packaging, distribution, and sale of agricultural produce after it has been harvested.

Post-harvest technology is used to improve the quality and extend the shelf life of food. It also helps to reduce wastage and improve food safety.

In agriculture, postharvest handling is the stage of crop production immediately following harvest, including cooling, cleaning, sorting and packing. The instant a crop is removed from the ground, or separated from its parent plant, it begins to deteriorate.

Postharvest treatment largely determines final quality, whether a crop is sold for fresh consumption, or used as an ingredient in a processed food product.

Learning outcomes of the course unit

- Assessing postharvest losses and quality problems for crops
- Accessing online resources on postharvest information and extension
- Identifying small-scale postharvest technologies and potential solutions which are most appropriate for local target groups

Tom
HEAD
School of Agriculture
Ponnaiyah Ramajayam Institute of
Science & Technology (PRIST)
Institution Deemed to be University
11/53 of the UGC Act, 1956
TAVUR - 613 403, TAMIL NADU

V. S. S.
DEAN
School of Agriculture
Ponnaiyah Ramajayam Institute
Science & Technology (PRIST)
Institution Deemed to be University
11/53 of the UGC Act, 1956
TAVUR - 613 403, TAMIL NADU

- Performing Cost / Benefit calculations for assessing economic feasibility of recommended postharvest technologies
- Designing postharvest demonstrations to show farmers, traders and marketers how to reduce losses, maintain quality and market value, increase shelf life and incomes
- Designing extension programs on postharvest technology topics
- Utilizing postharvest tools and equipment for quality evaluation
- Networking via social media and online forums with fellow "postharvest specialists"

COURSE CONTENT

Unit I: Post harvest technology of vegetable crops

Unit II: Post harvest technology of fruit crops

Unit III: Value addition flowers

Unit IV: Processing of plantation crop, spices, Medicinal plants and aromatic plants

Eligibility: Any graduates / ongoing degree students shall be eligible for the admission to the course.

Duration of the Program: 45 hrs. Value added Certificate Course.

Lecture Hours: 4.30 p.m. to 5.30 p.m. (Monday to Saturday)

Mode of Examination: Written Exam and seminar

Award of Certificate: The candidate successfully qualifying the course shall be awarded a certificate to that effect in the appropriate form by School of Agriculture, PRIST Deemed to be University, Vallam, Thanjavur.

[Handwritten Signature]

HEAD
 School of Agriculture
 Ponnaiyah Ramajayam Institute of
 Science & Technology (PRIST)
 Institution Deemed to be University
 11/5 3 of the UGC Act, 1956
 THANJAVUR - 613 403, TAMIL NADU

[Handwritten Signature]

DEAN
 School of Agriculture
 Ponnaiyah Ramajayam Institute of
 Science & Technology (PRIST)
 Institution Deemed to be University
 11/5 3 of the UGC Act, 1956
 THANJAVUR - 613 403, TAMIL NADU.



PONNAIYAH RAMAJAYAM INSTITUTE OF SCIENCE & TECHNOLOGY (PRIST)

Declared as DEEMED-TO-BE-UNIVERSITY
U/s 3 of UGC Act, 1956

SCHOOL OF AGRICULTURE

CIRCULAR

Date: 27.12.2023

This is to inform B.Sc., (HONS.) Agriculture students that the value-added course programme classes for the academic year 2023-2024 will be commenced from 03.01.2024. Hence, requesting all the registered students to attend the classes without fail.

DEAN

SCHOOL OF AGRICULTURE

DEAN

School of Agriculture
Ponnaiyah Ramajayam Institute of
Science & Technology (PRIST)
Institution Deemed to be University
U/s 3 of the UGC Act, 1956
THANJAVUR - 612 403, TAMIL NADU

Copy to,

All teaching staff members

Students

Co - Ordinator



PONNAIYAH RAMAJAYAM INSTITUTE OF SCIENCE & TECHNOLOGY (PRIST)

Declared as DEEMED-TO-BE-UNIVERSITY
U/s 3 of UGC Act, 1956

SCHOOL OF AGRICULTURE



INFORMATION BROCHURE

VALUE ADDED COURSE

B. Sc., (Hons.) Agriculture Programmes

Certificate course on

"AGRITOURISUM"

[Signature]
HEAD
School of Agriculture
Ponnaiyah Ramajayam Institute of
Science & Technology (PRIST)
Institution Deemed to be University
U/s 3 of the UGC Act, 1956
THANJAVUR - 613 403, TAMIL NADU

[Signature]
DEAN
School of Agriculture
Ponnaiyah Ramajayam Institute of
Science & Technology (PRIST)
Institution Deemed to be University
U/s 3 of the UGC Act, 1956
THANJAVUR - 613 403, TAMIL NADU

About the University

The Institute was founded in 1985 by Prof. P. Murugesan. It was initially known as the Institute of Computer Science and Technology. Murugesan founded the Institute to introduce computer education to the Thanjavur District. In 1988, the Institute received affiliation from Bharathidasan University to offer Postgraduate Diploma Programmes in Computer Applications.

Thereafter it expanded to include an Arts and Science College, College of Engineering and Technology, College of Education, Research Institution, and Polytechnic College.

In 2004, Ponnaiya Ramajayam College applied for NAAC assessment and accreditation and was awarded an "A" grade, thus making it the first "A" grade awarded college in the Bharathidasan University area. The college then submitted its proposal to the Ministry of Human Resource Development, Government of India for deemed university status.

On 4 January 2008, the Institute was conferred deemed university status based on the recommendations of the UGC Expert Committee, the Ministry of HRD, and the Government of India. The Institute also received approval from the Distance Education Council (DEC) and its B.Ed. course is approved by The National Council for Teacher Education (NCTE).

Currently, the Institute offers degrees in Medicine, Engineering, Arts & Science, Education, Pharmacy, Management, Agriculture and Technology, as well as Ph.D. programmes in some of these fields.

About the Department

The School of Agriculture under Ponnaiyah Ramajayam Institute of Science and Technology (PRIST) was established at Vallam, Thanjavur in the year 2016.

The agriculture is intended to impart high quality education to produce not just agricultural graduates but agro technocrats with practical

[Signature]
HEAD
School of Agriculture
Ponnaiyah Ramajayam Institute of
Science & Technology (PRIST)
Institution Deemed to be University
No 3 of the UGC Act, 1956
THANJAVUR - 613 403, TAMIL NADU.

[Signature]
DEAN
School of Agriculture
Ponnaiyah Ramajayam Institute of
Science & Technology (PRIST)
Institution Deemed to be University
No 3 of the UGC Act, 1956
THANJAVUR - 613 403, TAMIL NADU.

and conceptual skills. With precise and deliberate course modules, which provides education, research and training along with first hand field experiences, the students would sure be transformed as skilled human resources.

The department has spacious laboratories such as Plant Pathology, Microbiology, Agricultural Entomology, Agricultural Botany and Genetics, Agronomy, Horticulture, Economics lab and Audio - Visual lab. All the laboratories are fully equipped with latest, modern and sophisticated equipment.

The Department has young as well as experienced and dynamic personalities as faculty, is involved in providing quality education at Undergraduate (UG) levels. The staffs are from various disciplines in Doctorate like Plant Pathology, Microbiology, Soil science, Plant Genetics and Veterinary. The staffs are from various disciplines in masters like Agricultural Entomology, Agronomy, Agricultural Extension, Horticulture and Economics. Many of the staff members are encouraged to pursue their higher studies and research works.

About the Course

Introduction and Overview

- Agritourism is a business model that is growing in popularity as Indiana farmers recognize a need to diversify their operations and supplement their farm incomes.
- In addition, there is a growing public desire to engage in rural experiences and outdoor recreational activities.
- By combining agriculture and tourism, agritourism offers rural experiences to urban residents and economic diversification to farmers. Planning for agritourism requires a forward-thinking, locally-driven process.

HEAD
School of Agriculture
Ponnaiyah Ramajayam Institute of
Science & Technology (PRIST)
Institution Deemed to be University
U/s 3 of the UGC Act, 1956
THANJAVUR - 613 403, TAMIL NADU

ILRC designed the planning
School of Agriculture
Ponnaiyah Ramajayam Institute of
Science & Technology (PRIST)
Institution Deemed to be University
U/s 3 of the UGC Act, 1956
THANJAVUR - 613 403, TAMIL NADU

guide for agritourism providers, community leaders, extension agents, and rural economic development and tourism professionals.

What is agritourism?

- Agritourism, sometimes called rural tourism, is a subset of the leisure and hospitality industry that combines elements of tourism and agriculture. Although farm tourism is one of the most well-known types of agritourism, there is a wide array of businesses that fall under this category.
- In essence, any agricultural operation that provides tours or allows guests to visit or stay overnight on the property can be considered an agritourism business. Examples include:
 - Vineyards and wine tours
 - Family farms and hobby farms
 - Farm-to-table culinary experiences
 - Guest ranches or dude ranches
 - Barn weddings
 - Horseback rides and pony rides
 - Petting zoos
 - Corn mazes
 - Horse-drawn carriage and sleigh rides
 - Guided hunting trips on private land

Benefits of starting an agritourism business

- Many people who own an agricultural operation — such as a farm, ranch, or vineyard already have much of the necessary infrastructure to start an agritourism business, including land, attractions, and

Handwritten signature
HEAD
School of Agriculture
and Jayah Ramajayam Institute of
Science & Technology (PRIST)
Institution Deemed to be University
11/3 3 of the UGC Act, 1956
THANJAVUR - 613 403, TAMIL NADU

Handwritten signature
DEA
School of Agriculture
and Jayah Ramajayam Institute of
Science & Technology (PRIST)
Institution Deemed to be University
11/3 3 of the UGC Act, 1956
THANJAVUR - 613 403, TAMIL NADU

- Because this infrastructure often comes with a large overhead expense, the additional revenue generated by an agritourism venture can be a significant financial advantage when managed successfully.

Learn what it takes to manage a successful venture

- Developed by experts with significant experience in the tourism industry, this program provides the in-depth knowledge you need to successfully plan and manage an agritourism operation. Learn to adapt or expand existing infrastructure to create enjoyable, memorable experiences for visitors.
- Also gain insights in building a comprehensive business plan that includes elements like launching a website, promoting the business, booking guest reservations, organizing activities, managing finances, and complying with local laws and regulations.
- Offered in an online format, the program allows you to complete coursework on a flexible schedule, from the comfort of your own home.

Learning outcomes of the course unit

- To obtain and diversify knowledge from tourism, rural tourism and their specific form agri-tourism.

Course contents

Unit I: Agritourism - as part of rural development and tourism. Definition and forms. Strengths and weaknesses.

Unit II: Business projects - their content and development. Economic and environmental aspects of agritourism.

Unit III: Characteristics of quality and their grant.

Unit IV: Field exercises in agro-tourism farms and facilities.

HEAD

Unit V: Excursion on the international exhibition focusing on tourism, rural tourism and agri-tourism.

Handwritten signature

School of Agriculture
Ponnaiyah Ramajayam Institute of
Science & Technology (PRIST)
Institution Deemed to be University
Act 3 of the UGC Act, 1956
K. J. Somaiya Road - 613 403, TAMIL NADU.

DEAN
School of Agriculture
Ponnaiyah Ramajayam Institute of
Science & Technology (PRIST)
Institution Deemed to be University
Act 3 of the UGC Act, 1956
K. J. Somaiya Road - 613 403, TAMIL NADU.

Eligibility: Any graduates / ongoing degree students shall be eligible for the admission to the course.

Duration of the Program: 45 hrs. Value added Certificate Course.

Lecture Hours: 4.30 p.m. to 5.30 p.m. (Monday to Saturday)

Mode of Examination: Written Exam and seminar

Award of Certificate: The candidate successfully qualifying the course shall be awarded a certificate to that effect in the appropriate form by School of Agriculture, PRIST Deemed to be University, Vallam, Thanjavur.

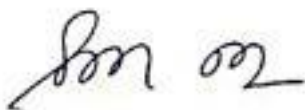

HEAD
School of Agriculture
Ponnaiyah Ramajayam Institute of
Science & Technology (PRIST)
Institution Deemed to be University
17/5 3 of the UGC Act, 1956
THANJAVUR - 613 403, TAMIL NADU.



DEAN
School of Agriculture
Ponnaiyah Ramajayam Institute of
Science & Technology (PRIST)
Institution Deemed to be University
17/5 3 of the UGC Act, 1956
THANJAVUR - 613 403, TAMIL NADU.



**PONNAIYAH RAMAJAYAM INSTITUTE OF
SCIENCE & TECHNOLOGY (PRIST)**

Declared as DEEMED-TO-BE-UNIVERSITY
U/s 3 of UGC Act, 1956

SCHOOL OF AGRICULTURE

CIRCULAR

Date: 10.8.2023

This is to inform B.Sc., (HONS.) Agriculture students that the value-added course programme classes for the academic year 2023-2024 will be commenced from 16.08.2023.

Hence, requesting all the registered students to attend the classes without fail.

DEAN

SCHOOL OF AGRICULTURE

DEAN

School of Agriculture
Ponnaiyah Ramajayam Institute of
Science & Technology (PRIST)
Institution Deemed to be University
U/s 3 of the UGC Act, 1956
THANJAVUR - 613 403, TAMIL NADU.

Copy to,

All teaching staff members

Students

Co - Ordinator



PONNAIYAH RAMAJAYAM INSTITUTE OF SCIENCE & TECHNOLOGY (PRIST)

Declared as DEEMED-TO-BE-UNIVERSITY
U/s 3 of UGC Act, 1956

SCHOOL OF AGRICULTURE



INFORMATION BROCHURE

VALUE ADDED COURSE

B. Sc., Agriculture

B. Sc., (HONS.) Agriculture

Certificate course on

DEAN

School of Agriculture
Ponnaiyah Ramajayam Institute of
Science & Technology (PRIST)
Deemed to be University
U/s 3 of UGC Act, 1956
K. J. Somaiya Institute of Management Studies & Research

“CONSERVATION AGRICULTURE”

HEAD

School of Agriculture
Ponnaiyah Ramajayam Institute of
Science & Technology (PRIST)
Deemed to be University
U/s 3 of UGC Act, 1956
K. J. Somaiya Institute of Management Studies & Research

About the University

The Institute was founded in 1985 by Prof. P. Murugesan. It was initially known as the Institute of Computer Science and Technology. Murugesan founded the Institute to introduce computer education to the Thanjavur District. In 1988, the Institute received affiliation from Bharathidasan University to offer Postgraduate Diploma Programmes in Computer Applications.

Thereafter it expanded to include an Arts and Science College, College of Engineering and Technology, College of Education, Research Institution, and Polytechnic College.

In 2004, Ponnaiya Ramajayam College applied for NAAC assessment and accreditation and was awarded an "A" grade, thus making it the first "A" grade awarded college in the Bharathidasan University area. The college then submitted its proposal to the Ministry of Human Resource Development, Government of India for deemed university status.

On 4 January 2008, the Institute was conferred deemed university status based on the recommendations of the UGC Expert Committee, the Ministry of HRD, and the Government of India. The Institute also received approval from the Distance Education Council (DEC) and its B.Ed. course is approved by The National Council for Teacher Education (NCTE).

In 2015, the Institute once again applied for NAAC assessment and accreditation and was awarded a "B" grade. In a letter signed by an undersecretary in the Union Health Ministry, it was stated that the Institute, which was granted conditional approval to offer 150 MBBS seats last year, was debarred from admitting students for the academic years of 2017-18 and 2018-19.

Currently, the Institute offers degrees in Medicine, Engineering, Arts & Science, Education, Pharmacy, Management, Agriculture and Technology, as well as Ph.D. programmes in some of these fields.

About the Department

The School of Agriculture under Ponnaiyah Ramajayam Institute of Science and Technology (PRIST) was established at Vallam, Thanjavur in the year 2016.

The department has spacious laboratories such as Plant Pathology, Microbiology, Agricultural Entomology, Agricultural Botany and Genetics, Agronomy, Horticulture

DEAN

School of Agriculture
Ponnaiyah Ramajayam Institute of
Science & Technology (PRIST)
Institution Deemed to be University
11/a 3 of the UGC Act, 1956
THANJAVUR - 613 403, TAMIL NADU.

HEAD

School of Agriculture
Ponnaiyah Ramajayam Institute of
Science & Technology (PRIST)
Institution Deemed to be University
11/a 3 of the UGC Act, 1956
THANJAVUR - 613 403, TAMIL NADU.

Economics lab and Audio – Visual lab. All the laboratories are fully equipped with latest, modern and sophisticated equipment.

The Department has young as well as experienced and dynamic personalities as faculty, is involved in providing quality education at Undergraduate (UG) levels. The staffs are from various disciplines in Doctorate like Plant Pathology, Microbiology, Soil science, Plant Genetics and Veterinary. The staffs are from various disciplines in masters like Agricultural Entomology, Agronomy, Agricultural Extension, Horticulture and Economics. Many of the staff members are encouraged to pursue their higher studies and research works.

About the Course

Introduction and Overview

- A system of "resource-saving agricultural crop production that aims to achieve acceptable profits, high and sustained production levels while concurrently conserving the environment

What is Conservation Agriculture?

Conservation Agriculture (CA) is a farming system that can prevent losses of arable land while regenerating degraded lands. It promotes maintenance of a permanent soil cover, minimum soil disturbance, and diversification of plant species. It enhances biodiversity and natural biological processes above and below the ground surface, which contribute to increased water and nutrient use efficiency and to improved and sustained crop production.

Objectives of Conservation Agriculture

- Conservation agriculture aims to improve crop yields while protecting the environment and soil
- Conservation tillage minimizes soil loss by leaving at least 30% of crop residue on the surface.

Eligibility: Any graduates / ongoing degree students shall be eligible for the admission to the course.

Duration of the Program: 45 hrs. Value added Certificate Course.

Lecture Hours: 4.30 p.m. to 5.30 p.m. (Monday to Saturday)

Amrith
HEAD
School of Agriculture
Ponnaiyah Ramajayam Institute of
Science & Technology (PRIST)
Institution Deemed to be University
Act 3 of the UGC Act, 1956
TIRUNELVELI - 610 403, TAMIL NADU.

Vm
DEAN
School of Agriculture
Ponnaiyah Ramajayam Institute of
Science & Technology (PRIST)
Institution Deemed to be University
Act 3 of the UGC Act, 1956
TIRUNELVELI - 610 403, TAMIL NADU.

Mode of Examination: Written Exam and seminar

Award of Certificate: The candidate successfully qualifying the course shall be awarded a certificate to that effect in the appropriate form by School of Agriculture, PRIST Deemed to be University, Vallam, Thanjavur.

Course content

Unit - 1 Introduction - Conservation Agriculture: Concepts, Brief History, and

Impacts on Agricultural System

Unit 2 – Elements of Conservation Agriculture - Crop Rotations and Residue Management in Conservation Agriculture - Weed Management in Conservation Agriculture Systems

Unit 3 - Conservation Agriculture in Agricultural Systems - Conservation Agriculture and Soil Carbon Sequestration

Unit 4 – Application of Microbiology in Conservation Agriculture - Evolution and Adoption of Conservation Agriculture

Unit 5 - Modeling Conservation Agriculture.

Dr. M. S.
HEAD
School of Agriculture
Ponnaiyah Ramajayam Institute of
Science & Technology (PRIST)
Institution Deemed to be University
U/s 3 of the UGC Act, 1956
THANJAVUR - 613 403, TAMIL NADU.

V. S.
DEAN
School of Agriculture
Ponnaiyah Ramajayam Instit.
Science & Technology (PRIST)
Institution Deemed to be Uni
U/s 3 of the UGC Act, 1956
THANJAVUR - 613 403, TAMIL NADU.



**PONNAIYAH RAMAJAYAM INSTITUTE OF
SCIENCE & TECHNOLOGY (PRIST)**

Declared as DEEMED-TO-BE-UNIVERSITY
U/s 3 of UGC Act, 1956

SCHOOL OF AGRICULTURE

CIRCULAR

Date: 26.2.2024

This is to inform B.Sc., (HONS.) Agriculture students that the value-added course programme classes for the academic year 2023-2024 will be commenced from 11.03.2024. Hence, requesting all the registered students to attend the classes without fail.

DEAN

SCHOOL OF AGRICULTURE

DEAN

**School of Agriculture
Ponnaiyah Ramajayam Institute of
Science & Technology (PRIST)
Institution Deemed to be University
U/s 3 of the UGC Act, 1956
PONDICHERRY - 605 003, TAMIL NADU.**

Copy to,

All teaching staff members

Students

Co - Ordinator



**PONNAIYAH RAMAJAYAM INSTITUTE OF
SCIENCE & TECHNOLOGY (PRIST)**

Declared as DEEMED TO-BE-UNIVERSITY
U/s 3 of UGC Act, 1956

SCHOOL OF AGRICULTURE



INFORMATION BROCHURE

VALUE ADDED COURSE

B. Sc., Agriculture

B. Sc., (HONS.) Agriculture

Certificate course on

“HI-TECH NURSERY”

HEAD

School of Agriculture

**Ponnaiyah Ramajayam Institute of
Science & Technology (PRIST)**
Institution Deemed to be University
U/s 3 of the UGC Act, 1956
THANJAVUR - 613 403, TAMIL NADU.

DEAN

School of Agriculture
**Ponnaiyah Ramajayam Institute of
Science & Technology (PRIST)**
Institution Deemed to be University
U/s 3 of the UGC Act, 1956
THANJAVUR - 613 403, TAMIL NADU.

About the University

The Institute was founded in 1985 by Prof. P. Murugesan. It was initially known as the Institute of Computer Science and Technology. Murugesan founded the Institute to introduce computer education to the Thanjavur District. In 1988, the Institute received affiliation from Bharathidasan University to offer Postgraduate Diploma Programmes in Computer Applications.

Thereafter it expanded to include an Arts and Science College, College of Engineering and Technology, College of Education, Research Institution, and Polytechnic College.

In 2004, Ponnaiya Ramajayam College applied for NAAC assessment and accreditation and was awarded an "A" grade, thus making it the first "A" grade awarded college in the Bharathidasan University area. The college then submitted its proposal to the Ministry of Human Resource Development, Government of India for deemed university status.

On 4 January 2008, the Institute was conferred deemed university status based on the recommendations of the UGC Expert Committee, the Ministry of HRD, and the Government of India. The Institute also received approval from the Distance Education Council (DEC) and its B.Ed. course is approved by The National Council for Teacher Education (NCTE).

In 2015, the Institute once again applied for NAAC assessment and accreditation and was awarded a "B" grade. In a letter signed by an undersecretary in the Union Health Ministry, it was stated that the Institute, which was granted conditional approval to offer 150 MBBS seats last year, was debarred from admitting students for the academic years of 2017-18 and 2018-19.

Currently, the Institute offers degrees in Medicine, Engineering, Arts & Science, Education, Pharmacy, Management, Agriculture and Technology, as well as Ph.D. programmes in some of these fields.

About the Department

The School of Agriculture under Ponnaiyah Ramajayam Institute of Science and Technology (PRIST) was established at Vallam, Thanjavur in the year 2016.

The department has spacious laboratories such as Plant Pathology, Microbiology, Agricultural Entomology, Agricultural Botany and Genetics, Agronomy, Horticulture,

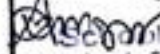
Dean
School of Agriculture
Ponnaiyah Ramajayam Institute of
Science & Technology (PRIST)
Institution Deemed to be University
UGC Act 1956
THANJAVUR - 613 403, TAMIL NADU.

Dean
School of Agriculture
Ponnaiyah Ramajayam Institute of
Science & Technology (PRIST)
Institution Deemed to be University
UGC Act 1956
THANJAVUR - 613 403, TAMIL NADU.

Economics lab and Audio – Visual lab. All the laboratories are fully equipped with latest, modern and sophisticated equipment.

The Department has young as well as experienced and dynamic personalities as faculty, is involved in providing quality education at Undergraduate (UG) levels. The staffs are from various disciplines in Doctorate like Plant Pathology, Microbiology, Soil science, Plant Genetics and Veterinary. The staffs are from various disciplines in masters like Agricultural Entomology, Agronomy, Agricultural Extension, Horticulture and Economics. Many of the staff members are encouraged to pursue their higher studies and research works.

About the Course

Introduction and Overview

Hi-tech nursery is a place where plants are raised from seeds/other vegetative methods for production of new plants under protected and controlled conditions.

What is Hi – tech nursery?

Hi Tech Nursery is a combination of poly green house and agrinet house. Vegetative reproduction is used in such nurseries to ensure genetic similarities with the source.

Objectives of Hi - tech nursery

- To produce quality seedlings in a protected environment for growers, which can lead to higher crop productivity.

Eligibility: Any graduates / ongoing degree students shall be eligible for the admission to the course.

Duration of the Program: 45 hrs. Value added Certificate Course.

Lecture Hours: 4.30 p.m. to 5.30 p.m. (Monday to Saturday)

Mode of Examination: Written Exam and seminar

Award of Certificate: The candidate successfully qualifying the course shall be awarded a certificate to that effect in the appropriate form by School of Agriculture, PRIST Deemed to be University, Vallam, Thanjavur.

See on
HEAD
School of Agriculture
Ponnaiyah Ramajayam Institute of
Science & Technology (PRIST)
Institution Deemed to be University
- 31 - UGC Act, 1956
THANJAVUR - 613 403, TAMIL NADU.

Wm
DEAN
School of Agriculture
Ponnaiyah Ramajayam Institute of
Science & Technology (PRIST)
Institution Deemed to be University
- 31 - UGC Act, 1956
THANJAVUR - 613 403, TAMIL NADU.

Course content

Unit - 1 Introduction - importance & scope of hi-tech nursery in India

Unit 2 – Hi-tech nursery management & mechanization of horticultural crops

Unit 3 – Micro propagation of horticultural crops

Unit 4 – Hi-tech field preparation and planting methods

Unit 5 - Environmental control in green house- temperature, light, Co2, relative humidity and ventilation methods & techniques.

Accepted

School of Agriculture
Ponnaiyah Ramajayam Institute of
Science & Technology (PRIST)
Institution Deemed to be University
U-3 of the UGC Act, 1956
TIRANJAVUR - 613 403, TAMIL NADU.

W

DEAN
School of Agriculture
Ponnaiyah Ramajayam Institute of
Science & Technology (PRIST)
Institution Deemed to be University
U-3 of the UGC Act, 1956
TIRANJAVUR - 613 403, TAMIL NADU.

SCHOOL OF AGRICULTURE
" KITCHEN GARDEN " STUDENTS ATTENDANCE

S.NO	REGISTER NO.	NAME	30/10	31/10	01/11	02/11	03/11	04/11	05/11	06/11	07/11	08/11	09/11	10/11	11/11	12/11	13/11	14/11	15/11	16/11	17/11	20/11
1.	2001AG10205	YUVASHREE I	/	/	/	/	a	/	/	/	/	/	/	a	/	/	/	/	/	/	/	/
2.	2001AG10206	MANO RANJANI S	/	a	/	/	/	/	/	/	/	/	/	/	/	/	/	/	/	/	/	/
3.	2001AG10207	LAVANYA A	/	/	/	/	/	/	/	/	/	/	/	/	/	/	/	/	/	/	/	/
4.	2001AG10208	YOGABARATI T	/	a	/	/	/	/	/	/	/	/	a	/	/	/	/	/	/	/	/	/
5.	2001AG10209	SANGEETHA P	/	/	/	/	/	/	a	/	/	/	/	/	/	/	/	/	a	/	/	/
6.	2001AG10211	POONGKODI V	/	/	/	a	/	/	/	/	/	/	/	/	/	/	/	/	/	a	/	/
7.	2001AG10212	DHARSHINI S	a	/	/	/	/	/	/	/	/	a	/	/	/	/	/	/	/	/	/	a
8.	2001AG10214	HENIN SHRUTHI E	/	/	/	/	/	/	/	/	/	/	/	/	/	/	/	/	/	/	/	/
9.	2101AG10101	Kumaraguru.D	/	/	/	/	a	/	/	/	/	/	/	/	/	/	/	/	/	/	/	/
10.	2101AG10103	Thirukameswarar R	a	/	/	/	/	/	/	a	/	/	/	/	/	/	/	/	/	/	/	/
11.	2101AG10104	Sivanath U.	/	/	a	/	/	/	/	/	/	/	a	/	/	/	/	/	/	/	/	/
12.	2101AG10105	Shree krishna. S	/	/	/	/	/	/	/	/	/	/	/	/	/	/	/	/	/	/	/	/
13.	2101AG10107	Dhanush kumar. G	/	/	/	/	/	/	/	/	/	/	/	a	/	/	/	/	/	/	/	/
14.	2101AG10108	Harinath. R	a	/	/	/	/	/	/	/	/	/	/	/	/	/	/	/	/	/	/	/
15.	2201AG10102	M. Madhan	/	/	/	/	/	/	/	/	/	/	/	/	/	/	/	/	/	/	/	/
16.	2201AG10107	V. Vetrivel	/	/	/	/	/	/	/	a	/	/	/	/	/	/	/	/	/	/	/	/

HEAD

DEAN

School of Agriculture
Ponnaiyah Ramajayam Institute of
Science & Technology (PRIST)
Institution Deemed to be University
Ute 3 of the UGC Act.1956
THANJAVUR - 613 403, TAMIL NADU.

School of Agriculture
Ponnaiyah Ramajayam Institute of
Science & Technology (PRIST)
Institution Deemed to be University
Ute 3 of the UGC Act.1956
THANJAVUR - 613 403, TAMIL NADU.

S. NO	REGISTER NO.	NAME	30/01/11	01/02/11	02/03/11	06/04/11	07/05/11	08/06/11	09/07/11	10/08/11	13/09/11	14/10/11	15/11/11	16/12/11	17/01/12	20/02/12
17.	2201AG10108	C. Karthiavan	a	/	/	/	a	/	/	/	/	/	/	/	/	/
18.	2201AG10111	G. Nagaraj	/	/	/	/	/	/	/	/	/	/	a	/	/	/
19.	2201AG10114	A. Abdul Waajith	/	/	/	/	a	/	/	/	/	a	/	/	/	/
20.	2201AG10115	S. Vinith	/	/	/	/	/	a	/	/	/	/	/	/	/	/

Am on

HEAD
 School of Agriculture
 Ponnaiyah Ramaiyamn
 Science & Technology (PRIST)
 Institution Deemed to be University
 U-3 of the UGC Act, 1956
 THANJAVUR - 613 403, TAMIL NADU.

Veri

SCHOOL OF AGRICULTURE

DEAN

DEAN
 School of Agriculture
 Ponnaiyah Ramaiyamn
 Science & Technology (PRIST)
 Institution Deemed to be University
 U-3 of the UGC Act, 1956
 THANJAVUR - 613 403, TAMIL NADU.

SCHOOL OF AGRICULTURE
" KITCHEN GARDEN " STUDENTS ATTENDANCE

S.NO	REGISTER NO.	NAME	21	22	23	24	27	28	29	30	01	04	05	06	07	08	11	12
1.	2001AG10205	YUVASHREE I	1	1	1	1	1	1	1	1	1	1	1	1	1	1	1	1
2.	2001AG10206	MANO RANJANI S	1	1	a	1	1	1	1	a	1	1	1	1	1	1	1	1
3.	2001AG10207	LAVANYA A	1	1	1	1	a	1	1	1	1	1	1	1	1	1	1	1
4.	2001AG10208	YOGABARATI T	1	1	1	1	1	1	a	1	1	1	1	1	1	1	1	1
5.	2001AG10209	SANGEETHA P	1	1	1	1	1	1	1	1	1	1	1	1	1	1	1	1
6.	2001AG10211	POONGKODI V	1	1	1	1	1	1	1	1	1	1	1	1	1	1	1	1
7.	2001AG10212	DHARSHINI S	1	1	1	1	1	a	1	a	1	1	1	1	1	1	1	1
8.	2001AG10214	HENIN SHRUTHI E	1	1	1	1	1	1	1	1	1	1	1	1	a	1	1	1
9.	2101AG10101	Kumaraguru.D	1	1	1	1	1	1	1	1	1	1	1	1	1	1	1	1
10.	2101AG10103	Thirukameswarar R	1	1	1	1	1	1	1	1	1	a	1	a	1	1	1	1
11.	2101AG10104	Sivanath U.	a	1	1	1	1	1	1	1	1	1	a	1	1	1	1	1
12.	2101AG10105	Shree Krishna. S	1	1	1	1	1	a	1	1	1	1	1	1	1	1	1	1
13.	2101AG10107	Dhanush Kumar. G	1	1	1	1	1	1	1	1	a	1	1	1	1	1	1	1
14.	2101AG10108	Harinath. R	1	1	1	1	1	1	1	1	1	1	1	1	1	1	1	a
15.	2201AG10102	M. Madhan	1	1	1	1	1	1	1	1	1	1	1	1	1	1	1	a
16.	2201AG10107	V. Vetrivel	a	1	1	1	1	1	1	1	1	1	1	1	1	a	1	1

Handwritten signature/initials

Handwritten signature/initials

Principal, P. Ramasamy
 School of Agriculture
 Anna University
 Chennai - 600 029

SCHOOL OF AGRICULTURE
 Anna University
 Regional Agricultural Institute of
 Science & Technology (PAIST)
 Institution Overlaid to Anna University
 ... 3 of the UGC Act, 1956
 THIRUAVUR - 613 403, TAMIL NADU.

S.NO	REGISTER NO.	NAME	21/11	22/11	23/11	24/11	25/11	26/11	27/11	28/11	29/11	30/11	01/12	02/12	03/12	04/12	05/12	06/12	07/12	08/12	11/12	12/12
17.	2201AG10108	C. Kathiravan	1	1	2	1	1	1	1	1	1	1	1	1	1	1	1	1	1	1	1	1
18.	2201AG10111	G. Nagaraj	1	1	1	1	1	1	1	1	1	1	1	1	1	1	1	1	1	1	1	1
19.	2201AG10114	A. Abdul Waajith	1	1	1	1	1	1	1	1	1	1	1	1	1	1	1	1	1	1	1	1
20.	2201AG10115	S. Vimuth	1	1	1	1	1	1	1	1	1	1	1	1	1	1	1	1	1	1	1	1

Done

Done

School of Agriculture
 Ponnalyah Ramajayan Institute of
 Science & Technology (PRIISIT)
 Ponnalyah Ramajayan Institute of
 Science & Technology
 Ponnalyah Ramajayan Institute of
 Science & Technology
 Ponnalyah Ramajayan Institute of
 Science & Technology

SCHOOL OF AGRICULTURE
 DEAN
 School of Agriculture
 Ponnalyah Ramajayan Institute of
 Science & Technology (PRIISIT)
 Ponnalyah Ramajayan Institute of
 Science & Technology
 Ponnalyah Ramajayan Institute of
 Science & Technology
 Ponnalyah Ramajayan Institute of
 Science & Technology

SCHOOL OF AGRICULTURE
" KITCHEN GARDEN " STUDENTS ATTENDANCE

S. NO	REGISTER NO.	NAME																		
1.	2001AG10205	YUVASHREE I	13/12	14/12	15/12	18/12	19/12	20/12	21/12	22/12	26/12	27/12	28/12	29/12	30/12	31/12	01/01	03/01	04/01	05/01
2.	2001AG10206	MANO RANJANI S	/	a	/	/	/	/	a	/	/	a	/	/	/	/	/	/	/	a
3.	2001AG10207	LAVANYA A	/	/	/	/	a	/	/	/	/	/	a	/	/	/	/	/	/	/
4.	2001AG10208	YOGABARATI T	/	/	/	/	/	/	a	/	/	/	/	/	/	/	/	/	/	/
5.	2001AG10209	SANGEETHA P	/	/	/	/	/	/	/	/	/	/	/	/	/	/	/	/	/	/
6.	2001AG10211	POONGKODI V	/	/	/	/	a	/	/	/	/	/	/	a	/	/	/	/	/	/
7.	2001AG10212	DHARSHINI S	/	/	a	/	/	/	/	/	/	/	/	/	a	/	/	/	/	/
8.	2001AG10214	HENIN SHRUTHI E	/	/	/	/	/	/	/	/	/	/	/	/	/	/	/	/	a	/
9.	2101AG10101	Kumaraguru.D	/	/	a	/	/	/	/	/	/	/	/	/	/	/	/	/	/	/
10.	2101AG10103	Thirukameswarar R	/	a	/	/	/	/	/	/	/	/	/	/	/	/	/	/	/	/
11.	2101AG10104	Sivanath U.	a	/	/	/	/	/	/	a	/	/	/	/	/	/	/	/	/	/
12.	2101AG10105	Shree krishna. S	/	/	/	/	/	/	/	a	/	/	/	/	/	/	/	/	/	/
13.	2101AG10107	Dhanush kumar. G	/	/	/	/	/	/	/	/	/	/	/	/	/	/	/	/	/	/
14.	2101AG10108	Harinath. R	a	/	/	/	/	/	/	/	/	/	/	/	/	/	/	/	/	/
15.	2201AG10102	M. Madhan	/	a	/	/	/	/	/	/	a	/	/	/	/	/	/	/	/	/
16.	2201AG10107	V. Vetrivel	/	/	/	a	/	a	/	/	/	/	/	/	/	/	/	/	/	/

HELEN

VEN

School of Agriculture
 Pennatyah Ramajivam Institute of
 Science & Technology (PRIST)
 Institution Deemed to be University
 Act 3 of the UGC Act, 1956
 THANJAVUR - 613 403, TAMIL NADU.

School of Agriculture
 Pennatyah Ramajivam Institute of
 Science & Technology (PRIST)
 Institution Deemed to be University
 Act 3 of the UGC Act, 1956
 THANJAVUR - 613 403, TAMIL NADU.

S.NO	REGISTER NO.	NAME	13/12	14/12	15/12	18/12	19/12	20/12	21/12	22/12	24/12	27/12	28/12	29/12	01/01	02/01	04/01	05/01
17.	2201AGI0108	C. Kathiravan	1	1	1	1	2	1	1	2	1	1	1	1	1	1	1	1
18.	2201AGI0111	G. Nagaraj	1	1	1	1	1	1	1	1	1	1	1	2	1	1	1	1
19.	2201AGI0114	A. Abdul Wasjith	1	1	1	1	1	1	1	1	2	1	1	1	1	1	2	1
20.	2201AGI0115	S. Vinith	1	1	1	1	1	1	1	1	1	2	1	1	1	2	1	1

Am

HEAD

School of Agriculture
Ponnalyah Ramajayam Institute of
Science & Technology (PRIST)
Institution Deemed to be University
Act 3 of the UGC Act, 1956
THANJAVUR - 613 403, TAMIL NADU.

DEAN

SCHOOL OF AGRICULTURE

DEAN

School of Agriculture
Ponnalyah Ramajayam Institute of
Science & Technology (PRIST)
Institution Deemed to be University
Act 3 of the UGC Act, 1956
THANJAVUR - 613 403, TAMIL NADU.

Am

SCHOOL OF AGRICULTURE
" AGRI - TOURISM " STUDENTS ATTENDANCE

S.NO	REGISTER NO.	NAME	3/1	4/1	5/1	6/1	7/1	8/1	9/1	10/1	11/1	12/1	13/1	14/1	15/1	16/1	17/1	18/1	19/1	20/1	21/1	22/1	23/1	24/1
1.	2101AG10202	Sangavi. K	/	/	/	/	/	/	/	/	a	/	/	/	/	/	/	/	/	/	/	/	/	/
2.	2101AG10204	Nisha. J	/	/	/	/	/	/	/	/	a	/	/	/	/	/	/	/	/	/	/	/	/	/
3.	2101AG10205	Kaviya shree.l.s	a	/	/	/	/	/	/	/	/	/	/	/	a	/	/	/	/	/	/	/	/	/
4.	2101AG10206	Sakthimenu G.	/	/	/	/	/	/	/	/	/	/	/	/	/	/	/	/	/	/	/	/	/	/
5.	2101AG10207	Meenakshi P.	/	/	/	/	/	/	/	/	/	/	/	/	/	/	/	/	/	/	/	/	/	/
6.	2101AG10208	Vijayalakshmi. K	/	/	/	/	/	/	a	/	/	/	/	/	/	/	/	/	/	/	/	/	/	/
7.	2101AG10209	Akshara. v	/	/	a	/	/	/	/	/	/	/	/	/	/	/	/	/	/	/	/	/	/	/
8.	2101AG10108	Harinath. R	/	a	/	/	/	/	a	/	/	/	/	/	/	a	/	/	/	/	/	/	/	/
9.	2101AG10109	Kabilan. R	/	/	/	a	/	/	/	/	/	/	/	/	/	/	/	/	/	/	/	/	/	/
10.	2201AG10214	S. Sumithra	/	/	/	/	/	/	/	/	/	/	/	/	/	/	/	/	/	/	/	/	/	/
11.	2201AG10208	Yoha shivani	/	/	/	/	/	/	/	/	/	/	/	/	/	/	/	/	/	/	/	/	/	/
12.	2201AG10117	Vignesh S	/	a	/	/	/	/	/	/	/	/	/	/	/	/	/	/	/	/	/	/	/	/
13.	2101AG10101	Kumaraguru.D	/	/	/	/	/	a	/	/	/	/	/	/	/	/	/	/	/	/	/	/	/	/
14.	2101AG10103	Thirukameswarar R	/	/	/	/	/	/	/	/	/	/	/	/	/	/	/	/	/	/	/	/	/	/
15.	2101AG10104	Sivanath U.	/	/	/	/	/	/	/	/	/	/	/	/	/	/	/	/	/	/	/	/	/	/

Handwritten signature

HEAD

School of Agriculture
 Ponnaiyah Ramajayam Institute of
 Science & Technology (P.R.I.S.T)
 Institution Deemed to be University
 Affiliated to the UGC Act 1956
 THANJAVUR - 613 403, TAMIL NADU.

Handwritten signature

SCHOOL OF AGRICULTURE

DEAN

School of Agriculture
 Ponnaiyah Ramajayam Institute of
 Science & Technology (P.R.I.S.T)
 Institution Deemed to be University
 Affiliated to the UGC Act 1956
 THANJAVUR - 613 403, TAMIL NADU.

SCHOOL OF AGRICULTURE

" AGRI - TOURISM " STUDENTS ATTENDANCE

S.NO	REGISTER NO.	NAME	24	25	26	27	28	29	30	31	32	33	34	35	36	37	38	39	40
1.	2101AG10202	Sangavi. K	/	/	a	/	/	/	/	/	/	/	/	/	/	/	/	/	/
2.	2101AG10204	Nisha. J	/	/	/	/	/	/	/	/	/	/	/	/	/	/	/	/	/
3.	2101AG10205	Kavya shree.l.s	/	/	/	/	/	a	/	/	/	/	/	/	/	/	/	/	/
4.	2101AG10206	Sakthimcenu G.	/	/	/	/	/	/	/	/	/	/	/	/	/	/	/	/	/
5.	2101AG10207	Meenakshi P.	/	/	/	/	/	/	/	/	/	/	/	/	/	/	/	/	/
6.	2101AG10208	Vijayalakshmi. K	/	/	/	/	/	/	a	/	/	/	/	/	/	/	/	/	/
7.	2101AG10209	Akshara.v	/	/	/	/	/	/	/	/	/	/	/	/	/	/	/	/	/
8.	2101AG10108	Harinath. R	/	/	a	/	/	/	/	/	/	/	/	/	/	/	/	/	/
9.	2101AG10109	Kabilan. R	/	/	/	/	/	/	/	/	/	/	/	/	/	/	/	/	/
10.	2201AG10214	S. Sunithra	/	/	/	/	/	/	/	/	/	/	/	/	/	/	/	/	/
11.	2201AG10208	Yoha shivani	/	/	/	/	/	/	a	/	/	/	/	/	/	/	/	/	/
12.	2201AG10117	Vignesh S	/	/	/	/	/	/	/	/	/	/	/	/	/	/	/	/	/
13.	2101AG10101	Kumaraguru.D	/	/	/	/	/	/	/	/	/	/	/	/	/	/	/	/	/
14.	2101AG10103	Thirakameswarar R	/	/	a	/	/	/	/	/	/	/	/	/	/	/	/	/	/
15.	2101AG10104	Sivanath U.	/	/	/	/	/	/	/	/	/	/	/	/	/	/	/	/	/

for on

for

HEAD

School of Agriculture

SCHOOL OF AGRICULTURE

DEAN

Ponnaiyah Ramajayam
Institution for Science & Technology
Uthiramerathi
THANJAVUR - 613 402

Ponnaiyah Ramajayam
Institution Deemed to be
University
Uthiramerathi
THANJAVUR - 613 402

SCHOOL OF AGRICULTURE

" AGRI - TOURISM " STUDENTS ATTENDANCE

S.NO	REGISTER NO.	NAME	15/2	16/2	17/2	18/2	19/2	20/2	21/2	22/2	23/2	24/2	25/2	26/2	27/2	28/2	29/2	1/3	2/3
1.	2101AG10202	Sangavi. K	/	/	A	/	/	/	/	/	/	/	/	/	/	/	/	/	/
2.	2101AG10204	Nisha. J	/	/	/	/	/	/	A	/	/	/	/	/	/	/	/	/	/
3.	2101AG10205	Kaviya shree.l.s	/	/	/	/	/	/	/	A	/	/	/	/	/	/	/	/	/
4.	2101AG10206	Sakthimeenu G.	/	/	/	/	/	/	/	/	/	/	/	/	/	/	/	/	/
5.	2101AG10207	Meenakshi P.	/	/	/	A	/	/	/	/	/	/	/	/	/	/	/	A	/
6.	2101AG10208	Vijayalakshmi. K	/	/	/	/	/	/	/	/	/	A	/	/	/	/	/	/	/
7.	2101AG10209	Akshara. v	/	/	/	/	/	/	/	A	/	/	/	/	/	/	/	/	A
8.	2101AG10108	Harinath. R	/	/	/	/	/	/	/	/	/	/	/	/	/	/	/	/	/
9.	2101AG10109	Kabilan. R	/	/	/	/	/	/	/	/	A	/	/	/	/	/	/	/	/
10.	2201AG10214	S. Sumithra	/	/	/	/	/	/	/	/	/	/	/	/	/	/	A	/	/
11.	2201AG10208	Yoha shivani	/	/	A	/	/	/	/	/	/	/	/	/	/	/	/	/	/
12.	2201AG10117	Vignesh S	/	/	/	/	/	/	/	/	/	A	/	/	/	/	/	/	/
13.	2101AG10101	Kumaraguru.D	/	/	/	/	/	/	/	/	/	/	/	/	A	/	/	/	/
14.	2101AG10103	Thirukameswarar R	/	/	/	/	/	/	/	/	/	/	/	/	/	/	/	/	A
15.	2101AG10104	Sivanath U.	/	/	/	/	/	/	/	/	/	A	/	/	/	/	/	/	/

Handwritten signature

HEAD

School of Agriculture

Puliyangudi, Tamil Nadu
 Agricultural University
 Thiruvananthapuram
 611 303, TAMIL NADU.

DEAN

SCHOOL OF AGRICULTURE

DEAN

School of Agriculture
 Puliyangudi, Tamil Nadu
 Agricultural University
 Thiruvananthapuram
 611 303, TAMIL NADU.

SCHOOL OF AGRICULTURE
"POST HARVEST TECHNOLOGY" STUDENTS ATTENDANCE

S.NO	REGISTER NO.	NAME	29/3	1/4	2/4	3/4	4/4	5/4	6/4	8/4	9/4	10/4	11/4	12/4	13/4	15/4	16/4	17/4
1.	2101AG10105	Shree krishna. S	/	α	/	/	/	/	/	/	/	/	/	α	/	/	/	/
2.	2101AG10107	Dhanushkumar. G	/	/	/	/	/	/	/	/	/	/	/	/	/	/	/	α
3.	2201AG10108	C. Kathiravan	/	/	/	/	α	/	/	/	/	/	/	/	/	/	/	/
4.	2201AG10107	V. Vetrivel	/	/	/	/	/	/	/	/	/	α	/	/	/	/	/	α
5.	2101AG10113	Ananda kumar A	/	/	/	/	/	/	/	/	/	/	/	/	/	/	/	/
6.	2101AG10201	Gunavazhagi. O	/	α	/	/	/	/	/	/	/	/	/	/	/	/	/	/
7.	2201AG10104	P. Kumarasamy	/	/	α	/	/	/	/	/	/	/	/	α	/	/	/	/
8.	2201AG10201	M. Sandhiya	/	/	/	/	/	α	/	/	/	/	/	/	/	/	/	/
9.	2201AG10209	S. Devika	/	/	/	/	/	/	/	/	/	α	/	/	/	/	/	/
10.	2201AG10202	C. Madhumitha	/	/	/	/	/	/	/	/	/	/	/	/	/	α	/	/
11.	2201AG10203	N. Lokeshwari	α	/	/	/	/	/	/	/	/	/	/	/	/	/	/	/

for m

Verd

HEAD
 School of Agriculture
 Ponnaiyah Ramajayam Institute of
 Science & Technology (PRIST)
 Institution Deemed to be University
 U/s 3 of the UGC Act, 1956
 THANJAVUR - 613 403, TAMIL NADU.

DEAN
 SCHOOL OF AGRICULTURE
 Ponnaiyah Ramajayam Institute of
 Science & Technology (PRIST)
 Institution Deemed to be University
 U/s 3 of the UGC Act, 1956
 THANJAVUR - 613 403, TAMIL NADU.

SCHOOL OF AGRICULTURE
"POST HARVEST TECHNOLOGY" STUDENTS ATTENDANCE

S. NO	REGISTER NO.	NAME	19	20	21	22	23	24	26	27	28	29	1/3	2/3	4/3	5/3	6/3	7/3
1.	2101AG10105	Shree Krishna. S	/	/	A	/	/	/	/	/	/	/	/	/	/	/	/	/
2.	2101AG10107	Dhanushkumar. G	/	/	/	/	/	/	/	/	A	/	/	/	/	/	/	/
3.	2201AG10108	C. Kathiravan	/	/	/	/	/	/	/	/	/	/	/	/	A	/	/	/
4.	2201AG10107	V. Vetrivel	/	/	/	/	A	/	/	/	/	/	/	/	/	/	/	/
5.	2101AG10113	Ananda Kumar A	/	/	/	/	/	/	/	/	/	/	/	/	/	/	A	/
6.	2101AG10201	Gunavazhagi. O	/	/	A	/	/	/	/	/	/	/	/	/	/	/	/	/
7.	2201AG10104	P. Kumarasamy	/	/	/	/	/	/	/	/	A	/	/	/	/	/	/	/
8.	2201AG10201	M. Sandhya	/	/	/	/	/	/	/	/	/	/	/	/	A	/	/	/
9.	2201AG10209	S. Devika	/	/	/	A	/	/	/	/	/	/	/	/	/	/	/	/
10.	2201AG10202	C. Madhumitha	/	/	/	/	/	/	/	/	/	A	/	/	/	/	/	/
11.	2201AG10203	N. Lokeshwari	/	/	/	/	/	/	/	/	/	/	/	/	/	/	A	/

Am on

Ver
DEAN

HEAD
School of Agriculture
 Ponnaiyah Ramajayam Institute of
 Science & Technology (PRIS I)
 Institution Deemed to be University
 U/s 3 of the UGC Act, 1956
 THANJAVUR - 613 403, TAMIL NADU.

SCHOOL OF AGRICULTURE
HEAD
School of Agriculture
 Ponnaiyah Ramajayam Institute of
 Science & Technology (PRIS I)
 Institution Deemed to be University
 U/s 3 of the UGC Act, 1956
 THANJAVUR - 613 403, TAMIL NADU.

SCHOOL OF AGRICULTURE
"POST HARVEST TECHNOLOGY" STUDENTS ATTENDANCE

S.NO	REGISTER NO.	NAME	8/3	11/3	12/3	14/3	15/3	18/3	19/3	20/3	21/3	22/3	23/3	24/3	25/3	27/3	28/3
1.	2101AG10105	Shree krishna. S	A	/	/	/	/	/	/	/	/	/	/	/	/	/	/
2.	2101AG10107	Dhanushkumar. G	/	/	/	A	/	/	/	/	/	/	/	/	/	/	/
3.	2201AG10108	C. Kathiravan	/	/	/	/	/	/	A	/	/	/	/	/	/	/	/
4.	2201AG10107	V. Vetrivel	/	/	/	/	/	/	/	/	/	/	/	/	/	/	/
5.	2101AG10113	Ananda kumar A	/	/	/	/	/	/	/	/	/	A	/	/	/	/	/
6.	2101AG10201	Gunavazhagi. O	/	/	/	/	/	/	/	/	/	/	/	/	/	/	/
7.	2201AG10104	P. Kumarasamy	/	/	/	/	/	A	/	/	/	/	/	/	/	/	/
8.	2201AG10201	M. Sandhiya	/	/	/	/	/	/	/	/	/	/	/	/	/	/	/
9.	2201AG10209	S. Devika	/	/	/	/	/	/	/	/	A	/	/	/	/	/	/
10.	2201AG10202	C. Madhumitha	/	/	/	/	/	/	/	/	/	/	/	/	/	/	/
11.	2201AG10203	N. Lokeshwari	/	/	/	/	/	/	/	/	/	/	/	/	A	/	/

Handwritten signature

Handwritten signature

HEAD
 School of Agriculture
 Punanaiyah Ramajayam Institute of
 Science & Technology (PRIST)
 Institution Deemed to be University
 U/s 3 of the UGC Act 1956
 THANJAVUR - 613 403, TAMIL NADU

DEAN
 SCHOOL OF AGRICULTURE
 Punanaiyah Ramajayam Institute of
 Science & Technology (PRIST)
 Institution Deemed to be University
 U/s 3 of the UGC Act, 1956
 THANJAVUR - 613 403, TAMIL NADU.

SCHOOL OF AGRICULTURE

"CONSERVATION AGRICULTURE" STUDENTS ATTENDANCE

S. NO	REGISTER NO.	NAME	16/8	17/8	18/8	21/8	22/8	23/8	24/8	25/8	26/8	28/8	29/8	30/8	31/8	1/9	2/9	4/9
1.	2001AGI0101	Thirumal S	/	/	/	a	/	/	/	/	/	/	/	/	/	/	/	/
2.	2001AGI0103	Ekashwaran T S K	/	/	/	/	/	/	/	/	a	/	/	/	/	/	a	/
3.	2001AGI0104	Jacob Kirubakaran E	/	/	a	/	/	/	/	/	/	/	/	a	/	/	/	/
4.	2001AGI0106	Parasuram S	/	/	/	/	/	/	/	/	/	/	/	/	/	/	/	/
5.	2001AGI0107	Srinivasan T	/	/	/	/	/	/	/	/	/	/	/	/	/	/	/	/
6.	2001AGI0108	Akash E	/	a	/	/	/	/	/	/	a	/	/	/	/	/	/	/
7.	2001AGI0109	Vengatesh Enbaa Sagar S	/	/	/	/	/	/	/	/	/	/	/	/	/	/	/	/
8.	2001AGI0110	Sanjay R	a	/	/	/	/	/	/	/	/	/	/	a	/	/	/	/
9.	2101AGI0107	Dhanush Kumar. G	/	/	/	/	/	/	/	/	/	/	/	/	/	/	/	/
10.	2101AGI0108	Harinath. R	/	/	/	/	/	/	/	/	/	/	/	/	/	/	/	/
11.	2101AGI0109	Kabilan. R	/	/	/	a	/	/	/	/	/	/	/	/	/	/	a	/
12.	2101AGI0113	Aranda Kumar A	/	/	/	/	/	/	/	/	/	/	/	/	/	/	/	/
13.	2101AGI0201	Gunavazhagi. O	/	/	/	/	/	/	/	/	/	/	/	/	a	/	/	/
14.	2101AGI0202	Sangavi. K	/	/	/	/	/	/	/	/	/	/	/	/	/	/	/	/
15.	2101AGI0204	Nisha. J	a	/	/	/	/	/	/	/	/	/	/	/	/	/	/	/
16.	2101AGI0107	Dhanush Kumar. G	/	/	/	/	/	/	/	/	/	/	/	/	a	/	/	/

[Signature]

[Signature]

School of Agriculture
Ponnaiyah Ramalingam Institute of
Science & Technology (PRIST)
Institution Deemed to be University
17's 3 of the UGC Act, 1956
THANJAVUR - 613 403, TAMIL NADU.

School of Agriculture
Ponnaiyah Ramalingam Institute of
Science & Technology (PRIST)
Institution Deemed to be University
17's 3 of the UGC Act, 1956
THANJAVUR - 613 403, TAMIL NADU.

S.NO	REGISTER NO.	NAME	1b/g	17/g	18/g	21/g	22/g	23/g	24/g	25/g	26/g	28/g	29/g	30/g	31/g	1/g	2/g	4/g
17.	2101AG10108	Harinath. R	/	/	/	/	/	/	/	a	/	/	/	/	/	/	/	a
18.	2201AG10102	M. Madhan	a	/	/	/	/	a	/	/	/	/	/	/	/	/	/	/
19.	2201AG10107	V. Vetrivel	/	/	/	a	/	/	/	/	/	a	/	/	/	/	/	/
20.	2201AG10108	C. Kathiravan	/	/	a	/	/	/	/	/	/	/	/	/	a	/	/	/

Shan

HEAD

School of Agriculture
Ponnaiyan Ramajayam Institute of
Science & Technology (PRIST)
Institution Deemed to be University
114 3 of the UGC Act, 1956
THANJAVUR - 613 403, TAMIL NADU.

DEAN

SCHOOL OF AGRICULTURE

Vani

DEAN
School of Agriculture
Ponnaiyan Ramajayam Institute of
Science & Technology (PRIST)
Institution Deemed to be University
114 3 of the UGC Act, 1956
THANJAVUR - 613 403, TAMIL NADU.

SCHOOL OF AGRICULTURE

"CONSERVATION AGRICULTURE" STUDENTS ATTENDANCE

S.NO	REGISTER NO.	NAME	5/9	6/9	7/9	8/9	9/9	11/9	12/9	13/9	14/9	15/9	18/9	19/9	21/9	22/9	23/9	25/9
1.	2001AG10101	Thirunmal S	/	/	/	/	/	/	a	/	/	/	/	/	/	a	/	/
2.	2001AG10103	Ekashwaran T S K	/	/	/	/	/	/	/	/	/	/	/	/	/	/	/	/
3.	2001AG10104	Jacob Kirubakaran E	/	/	/	a	/	/	/	/	/	/	/	a	/	/	/	/
4.	2001AG10106	Parasuram S	/	/	/	/	/	a	/	/	/	/	/	/	/	/	/	/
5.	2001AG10107	Srinivasan T	/	a	/	/	/	/	/	/	/	/	/	/	/	/	/	/
6.	2001AG10108	Akash E	/	/	/	/	/	/	/	/	a	/	/	/	/	/	/	/
7.	2001AG10109	Vengatesh Embaa Sagar S	/	/	/	/	/	/	/	/	/	/	/	/	/	/	/	/
8.	2001AG10110	Sanjay R	/	/	/	a	/	/	/	/	/	/	/	/	a	/	/	/
9.	2101AG10107	Dhanush Kumar. G	/	/	/	/	/	/	/	/	/	/	a	/	/	/	/	/
10.	2101AG10108	Harinath. R	a	/	/	/	/	/	/	/	/	/	/	/	/	/	/	/
11.	2101AG10109	Kabilan. R	/	/	a	/	/	/	a	/	/	/	/	/	/	/	/	/
12.	2101AG10113	Ananda Kumar A	/	/	/	/	/	/	/	/	/	/	a	/	/	/	/	/
13.	2101AG10201	Gunavazhagi. O	/	/	/	/	/	/	/	/	/	/	/	/	/	/	/	/
14.	2101AG10202	Sangavi. K	a	/	/	/	/	a	/	/	/	/	/	/	/	/	a	/
15.	2101AG10204	Nisha. J	/	/	/	/	/	/	/	/	/	/	/	/	/	/	/	/
16.	2101AG10107	Dhanush Kumar. G	/	/	/	/	/	/	a	/	/	/	/	/	/	/	/	/

[Handwritten Signature]

[Handwritten Signature]

School of Agriculture
Ponnaiyah Ramajayam Institute of
Science & Technology (PRIST)
Institution Deemed to be University
*As 3 of the UGC Act, 1956
TIRUVANJAVUR - 613 403, TAMIL NADU.

School of Agriculture
Ponnaiyah Ramajayam Institute of
Science & Technology (PRIST)
Institution Deemed to be University
*As 3 of the UGC Act, 1956
TIRUVANJAVUR - 613 403, TAMIL NADU.

S. NO	REGISTER NO.	NAME	5/9	6/9	7/9	8/9	9/9	10/9	11/9	12/9	13/9	14/9	15/9	16/9	17/9	18/9	19/9	20/9	21/9	22/9	23/9	24/9	25/9
17.	2101AG10108	Harinadh. R	/	/	/	/	/	/	/	a	/	/	/	/	/	/	/	/	/	/	/	/	/
18.	2201AG10102	M. Madhan	/	/	/	/	/	/	/	/	/	/	/	/	/	/	/	/	/	/	/	/	/
19.	2201AG10107	V. Veerivel	/	/	a	/	/	/	/	/	/	/	/	/	/	/	/	/	a	/	/	/	/
20.	2201AG10108	C. Kathiravan	/	/	/	/	/	/	/	/	/	/	/	/	/	/	/	/	/	/	/	/	/

Dean

HEAD

School of Agricutture
Ponnaiyeh Ramajayam Institute of
Science & Technology (PRIST)
Institution Deamed to the University
17/3 of the UGC Act, 1956
THANJAVUR - 613 403, TAMIL NADU

DEAN

SCHOOL OF AGRICULTURE

DEAN

School of Agricutture
Ponnaiyeh Ramajayam Institute of
Science & Technology (PRIST)
Institution Deamed to the University
17/3 of the UGC Act, 1956
THANJAVUR - 613 403, TAMIL NADU

Dean

SCHOOL OF AGRICULTURE
"CONSERVATION AGRICULTURE" STUDENTS ATTENDANCE

S.NO	REGISTER NO.	NAME	26/9	27/9	28/9	29/9	01/10	02/10	03/10	04/10	05/10	06/10	07/10	08/10	09/10	10/10	11/10	12/10	13/10	14/10	15/10	16/10
1.	2001AGI0101	Thirunal S	/	/	/	/	a	/	/	/	/	/	/	/	/	/	a	/	/	/	/	/
2.	2001AGI0103	Ekashwaran T S K	/	/	/	/	/	/	/	/	/	/	/	/	/	/	/	/	/	/	/	/
3.	2001AGI0104	Jacob Kirubakaran E	/	/	/	/	/	a	/	/	/	/	/	/	/	/	/	/	/	/	/	/
4.	2001AGI0106	Parasuram S	/	/	/	/	/	/	/	/	/	/	/	/	/	/	a	/	/	/	/	/
5.	2001AGI0107	Srinivasan T	/	/	/	/	a	/	/	/	/	/	/	/	/	/	/	/	a	/	/	/
6.	2001AGI0108	Akash E	/	/	/	/	/	/	/	/	/	/	/	/	/	/	/	/	/	/	/	/
7.	2001AGI0109	Vengatesh Enbaa Sagar S	/	/	a	/	/	/	/	/	/	/	/	/	/	/	/	a	/	/	/	/
8.	2001AGI0110	Sanjay R	/	/	/	/	/	/	/	/	/	/	a	/	/	/	/	/	/	/	/	/
9.	2101AGI0107	Dhanush Kumar. G	/	/	/	a	/	/	/	/	/	/	/	/	/	/	/	/	/	/	/	/
10.	2101AGI0108	Harinath. R	/	/	/	/	/	/	/	/	/	/	/	/	/	/	/	a	/	/	/	/
11.	2101AGI0109	Kabilan. R	/	/	/	/	/	/	/	/	/	/	/	/	/	/	/	/	/	/	/	/
12.	2101AGI0113	Ananda Kumar A	/	/	/	/	/	/	/	/	/	/	a	/	/	/	/	/	/	/	/	/
13.	2101AGI0201	Gunavazhagi. O	a	/	/	/	/	/	/	/	/	/	/	/	/	/	/	/	a	/	/	/
14.	2101AGI0202	Sangavi. K	/	/	/	/	/	/	/	/	/	/	/	/	/	/	/	/	/	/	/	/
15.	2101AGI0204	Nisha. J	/	/	/	/	/	a	/	/	/	/	/	/	/	/	/	/	/	/	/	/
16.	2101AGI0107	Dhanush Kumar. G	a	/	/	/	/	/	/	/	/	/	/	/	/	/	/	/	/	/	/	/

DEAN
SCHOOL OF AGRICULTURE

DEAN

Ponnaiyah Ramalingam Institute of
 Science & Technology (PRIST)
 Institution Deemed to be University
 3 of the UGC Act, 1956
 CAMPUS - 613 403, TAMIL NADU.

Ponnaiyah Ramalingam Institute of
 Science & Technology (PRIST)
 Institution Deemed to be Uni.
 3 of the UGC Act, 1956
 CHANNAYANUR - 613 403, TAMIL NADU.

S. NO	REGISTER NO.	NAME	01/9	02/9	03/9	04/9	05/9	06/9	07/9	08/9	09/9	10/9	11/9	12/9	13/9	14/9	15/9
17.	2101AG10108	Harinath. R	/	/	/	/	/	/	/	/	/	/	/	/	/	/	/
18.	2201AG10102	M. Madhan	/	/	/	/	/	/	/	/	/	/	/	/	/	/	/
19.	2201AG10107	V. Vetrivel	/	/	/	/	/	/	/	/	/	/	/	/	/	/	/
20.	2201AG10108	C. Kathiravan	/	/	/	/	/	/	/	/	/	/	/	/	/	/	/

Harinath

HEAD

School of Agriculture
Ponnaiyiah Ramajayam Institute of
Science & Technology (PRIST)
Institution Deemed to be University
115/3 of the UGC Act, 1956
THANJAVUR - 613 403, TAMIL NADU.

V. Vetrivel

DEAN

SCHOOL OF AGRICULTURE

DEAN

School of Agriculture
Ponnaiyiah Ramajayam Institute of
Science & Technology (PRIST)
Institution Deemed to be University
115/3 of the UGC Act, 1956
THANJAVUR - 613 403, TAMIL NADU.

SCHOOL OF AGRICULTURE

"HI - TECH NURSEY" STUDENTS ATTENDANCE

S.NO	REGISTER NO.	NAME	11/3	12/3	13/3	14/3	15/3	16/3	17/3	18/3	19/3	20/3	21/3	22/3	23/3	24/3	25/3	26/3	27/3	28/3	29/3	30/3	1/4	2/4	3/4	4/4	5/4	6/4	7/4	8/4	9/4	10/4	11/4	12/4	13/4	14/4	15/4					
1.	2001AGI0127	SUDHARSAN V	/	/	/	/	/	/	/	/	/	/	/	/	/	/	/	/	/	/	/	/	/	/	/	/	/	/	/	/	/	/	/	/	/	/	/	/	/	/		
2.	2001AGI0128	UMAR FAROOK F	/	/	/	/	/	/	/	/	/	/	/	/	/	/	/	/	/	/	/	/	/	/	/	/	/	/	/	/	/	/	/	/	/	/	/	/	/	/	/	
3.	2001AGI0129	SANJAY G	/	/	/	/	/	/	/	/	/	/	/	/	/	/	/	/	/	/	/	/	/	/	/	/	/	/	/	/	/	/	/	/	/	/	/	/	/	/	/	
4.	2001AGI0130	GIRI PRASATH S	/	/	/	/	/	/	/	/	/	/	/	/	/	/	/	/	/	/	/	/	/	/	/	/	/	/	/	/	/	/	/	/	/	/	/	/	/	/	/	
5.	2001AGI0131	LOGESHWARAN K	/	/	/	/	/	/	/	/	/	/	/	/	/	/	/	/	/	/	/	/	/	/	/	/	/	/	/	/	/	/	/	/	/	/	/	/	/	/	/	
6.	2001AGI0132	GOWTHAM M	/	/	/	/	/	/	/	/	/	/	/	/	/	/	/	/	/	/	/	/	/	/	/	/	/	/	/	/	/	/	/	/	/	/	/	/	/	/	/	
7.	2001AGI0201	KALEESHWARI S	/	/	/	/	/	/	/	/	/	/	/	/	/	/	/	/	/	/	/	/	/	/	/	/	/	/	/	/	/	/	/	/	/	/	/	/	/	/	/	
8.	2001AGI0202	PRIYA K	/	/	/	/	/	/	/	/	/	/	/	/	/	/	/	/	/	/	/	/	/	/	/	/	/	/	/	/	/	/	/	/	/	/	/	/	/	/	/	
9.	2001AGI0203	GOPIKA T	/	/	/	/	/	/	/	/	/	/	/	/	/	/	/	/	/	/	/	/	/	/	/	/	/	/	/	/	/	/	/	/	/	/	/	/	/	/	/	
10.	2001AGI0204	SWATHISRI T	/	/	/	/	/	/	/	/	/	/	/	/	/	/	/	/	/	/	/	/	/	/	/	/	/	/	/	/	/	/	/	/	/	/	/	/	/	/	/	/
11.	2101AGI0205	Kaviya shree.l.s	/	/	/	/	/	/	/	/	/	/	/	/	/	/	/	/	/	/	/	/	/	/	/	/	/	/	/	/	/	/	/	/	/	/	/	/	/	/	/	/
12.	2101AGI0206	Sakthimeenu G.	/	/	/	/	/	/	/	/	/	/	/	/	/	/	/	/	/	/	/	/	/	/	/	/	/	/	/	/	/	/	/	/	/	/	/	/	/	/	/	/
13.	2101AGI0207	Meenakshi P.	A	/	/	/	/	/	/	/	/	/	/	/	/	/	/	/	/	/	/	/	/	/	/	/	/	/	/	/	/	/	/	/	/	/	/	/	/	/	/	
14.	2101AGI0208	Vijayalakshmi. K	/	/	/	/	/	/	/	/	/	/	/	/	/	/	/	/	/	/	/	/	/	/	/	/	/	/	/	/	/	/	/	/	/	/	/	/	/	/	/	/
15.	2101AGI0209	Akshara. V	/	/	/	/	/	/	/	/	/	/	/	/	/	/	/	/	/	/	/	/	/	/	/	/	/	/	/	/	/	/	/	/	/	/	/	/	/	/	/	/
16.	2201AGI0214	S. Sumidra	/	/	/	/	/	/	/	/	/	/	/	/	/	/	/	/	/	/	/	/	/	/	/	/	/	/	/	/	/	/	/	/	/	/	/	/	/	/	/	/

Dr. Jaye AD
 School of Agriculture
 Ponnaiyeh Ramajayam Institute of
 Science & Technology (PRIIST)
 Institution Deemed to be University
 of the UGC Act. 1956
 403, 403, TAMIL NADU.

DRAN
 School of Agriculture
 Ponnaiyeh Ramajayam Institute of
 Science & Technology (PRIIST)
 Institution Deemed to be University
 of the UGC Act. 1956
 403, 403, TAMIL NADU.

S. NO	REGISTER NO.	NAME	11/3	12/3	13/3	14/3	15/3	16/3	17/3	18/3	19/3	20/3	21/3	22/3	23/3	24/3	25/3	26/3	27/3	28/3	29/3	30/3	1/4	2/4	3/4	4/4	5/4	6/4	7/4	8/4	9/4	10/4	11/4	12/4			
17.	2201AG10208	Yoha shivani N	/	/	/	/	/	/	2	/	/	/	/	/	/	/	/	/	/	/	/	/	/	/	/	/	/	/	/	/	/	/	/	/	/	/	
18.	2201AG10117	Vignesh S	/	/	/	/	/	/	/	/	/	/	/	/	/	/	/	/	/	/	/	/	/	/	/	/	/	/	/	/	/	/	/	/	/	/	/
19.	2201AG10102	M. Madhan	/	/	/	/	/	/	/	/	/	/	/	/	/	2	/	/	/	/	/	/	/	/	/	/	/	/	/	/	/	/	/	/	/	/	/
20.	2201AG10107	V. Vetrivel	/	/	/	/	/	/	/	/	/	/	/	/	/	/	/	/	/	/	/	/	/	/	/	/	/	/	/	/	/	/	/	/	/	/	/

Handwritten signature

HEAD

School of Agriculture
Ponnaiyah Ramajayam Institute of
Science & Technology (PRIST)
Insitution Deemed to be University
U/s 3 of the UGC Act, 1956
THANJAVUR - 613 403, TAMIL NADU.

Handwritten signature
DEAN

SCHOOL OF AGRICULTURE

DEAN

School of Agriculture
Ponnaiyah Ramajayam Institute of
Science & Technology (PRIST)
Insitution Deemed to be University
U/s 3 of the UGC Act, 1956
THANJAVUR - 613 403, TAMIL NADU.

SCHOOL OF AGRICULTURE
" III - TECH NURSEY " STUDENTS ATTENDANCE

S.NO	REGISTER NO.	NAME	18/4	20/4	23/4	25/4	27/4	29/4	31/5	3/5	4/5	6/5	8/5	10/5	13/5	15/5	17/5	20/5
1.	2001AGI0127	SUDHARSSAN V	/	/	/	/	/	/	/	a	/	/	/	/	/	/	/	/
2.	2001AGI0128	UMAR FAROOK F	/	/	a	/	/	/	/	/	/	/	/	/	/	/	a	/
3.	2001AGI0129	SANJAY G	/	/	/	/	/	/	/	/	/	/	/	/	/	/	/	/
4.	2001AGI0130	GIRI PRASATH S	/	/	/	/	/	/	/	/	/	/	/	/	/	/	/	/
5.	2001AGI0131	LOGESHWARAN K	a	/	/	/	/	/	a	/	/	/	/	/	/	/	/	/
6.	2001AGI0132	GOWTHAM M	/	/	/	/	/	/	/	/	a	/	/	/	/	/	/	/
7.	2001AGI0201	KALEESHWARI S	/	/	/	/	/	/	/	/	/	/	/	/	/	/	/	/
8.	2001AGI0202	PRIYA K	/	/	/	/	/	/	/	/	/	/	/	/	/	/	/	/
9.	2001AGI0203	GOPIKA T	/	/	/	/	/	a	/	/	/	/	/	/	/	/	/	/
10.	2001AGI0204	SWATHISRJI T	/	/	/	/	/	/	/	/	/	/	/	/	/	/	/	/
11.	2101AGI0205	Kaviya shreel.s	/	/	/	/	/	/	/	/	/	/	/	/	/	/	/	/
12.	2101AGI0206	Sakthimeenu G.	/	/	/	/	/	/	/	/	/	/	/	/	/	/	a	/
13.	2101AGI0207	Meenakshi P.	/	/	/	/	/	/	/	/	/	/	/	/	/	/	/	/
14.	2101AGI0208	Vijayalakshmi. K	/	/	a	/	/	/	/	/	/	/	/	/	/	/	/	/
15.	2101AGI0209	Akshara. V	/	/	/	/	/	/	/	/	/	/	/	/	/	/	/	/
16.	2201AGI0214	S. Sumithra	/	a	/	/	/	/	/	/	/	/	a	/	/	/	/	/

Average

School of Agriculture
Ramajayam Institute of
Technology (RIET)
Science & Technology
University
Deemed to be
University
U-3 of the UGC Act 1956
Warananur - 613 403, Tamil Nadu

W.A.S

School of Agriculture
Ramajayam Institute of
Technology (RIET)
Science & Technology
University
Deemed to be
University
U-3 of the UGC Act 1956
Warananur - 613 403, Tamil Nadu

S. NO	REGISTER NO.	NAME	18/4	20/4	23/4	25/4	27/4	29/4	1/5	3/5	4/5	6/5	8/5	10/5	13/5	15/5	20/5
17.	2201AG10208	Yoha shivani N	0	1	1	1	1	1	1	1	1	1	1	1	1	1	1
18.	2201AG10117	Vignesh S	1	1	1	1	1	1	1	1	1	1	1	1	1	1	1
19.	2201AG10102	M. Madhan	1	1	1	1	1	1	1	1	0	1	1	1	1	1	1
20.	2201AG10107	V. Vetrivel	1	1	1	0	1	1	1	1	1	1	1	1	1	1	1

Arum

V. Vetrivel

Director of Agriculture
 P. C. Annadurai Institute of
 Science & Technology (PRIST)
 Insititution Deamed to be University
 Ufa 3 of the UGC Act, 1956
 THANJAVUR - 613 403, TAMIL NADU

DEAN
 School of Agriculture
 Ponnaiyah Ramajayam Institute of
 Science & Technology (PRIST)
 Insititution Deamed to be University
 Ufa 3 of the UGC Act, 1956
 THANJAVUR - 613 403, TAMIL NADU

SCHOOL OF AGRICULTURE
"HI - TECH NURSEY" STUDENTS ATTENDANCE

S.NO	REGISTER NO.	NAME	22/11/24	23/11/24	24/11/24	25/11/24	27/11/24	28/11/24	29/11/24										
1.	2001AGI0127	SUDHARSAN V	/	/	/	/	/	/	/										
2.	2001AGI0128	UMAR FAROOK F	/	/	/	/	/	/	/										
3.	2001AGI0129	SANIAY G	/	/	/	a	/	/	/										
4.	2001AGI0130	GIRI PRASATH S	/	/	/	/	/	/	/										
5.	2001AGI0131	LOGESHWARAN K	/	/	/	/	/	/	/										
6.	2001AGI0132	GOWTHAM M	/	/	/	/	/	/	/										
7.	2001AGI0201	KALEESHWARI S	/	/	/	/	/	/	/										
8.	2001AGI0202	PRIYA K	a	/	/	/	/	/	/										
9.	2001AGI0203	GOPIKA T	/	/	/	/	/	/	a	/									
10.	2001AGI0204	SWATHISRIT	/	/	/	/	/	/	/										
11.	2101AGI0205	Kaviya shree.LS	/	/	/	/	/	/	/										
12.	2101AGI0206	Sakthimeenu G.	/	/	/	/	/	/	/										
13.	2101AGI0207	Mecnakshi P.	/	/	/	/	/	/	/										
14.	2101AGI0208	Vijayalakshmi. K	/	/	/	/	/	/	/										
15.	2101AGI0209	Akshara. V	/	/	/	/	/	/	/	a									
16.	2201AGI0214	S. Sumithra	/	/	/	/	/	/	/										

Arun
HEAD
 School of Agriculture
 Ponnaiyah Ramajayam Institute of
 Science & Technology (PRIST)
 Ponnaiyah Ramajayam Institute of
 Science & Technology
 Act. 1955

VEEN
 School of Agriculture
 Ponnaiyah Ramajayam Institute of
 Science & Technology
 Institution Deemed to be
 University
 JAVUR - 613 400
 Tamil Nadu

S. NO	REGISTER NO.	NAME	20/4	21/4	22/4	23/4	24/4	25/4	26/4	27/4	28/4	29/4								
17.	2201AGI0208	Yoha shivani N	/	/	/	/	/	/	/	/	/	/								
18.	2201AGI0117	Vignesh S	/	/	/	a	/	/	/	/	/	/								
19.	2201AGI0102	M. Madhan	/	/	/	/	/	/	/	/	/	/								
20.	2201AGI0107	V. Vetrivel	/	/	/	/	/	/	/	/	/	/								

[Handwritten Signature]

HEAD

School of Agriculture
Ponnaiyah Ramajayam Institute of
Science & Technology (PRIST)
Institution Deemed to be University
3 of the UGC Act, 1956
THANJAVUR - 613 403, TAMIL NADU.

[Handwritten Signature]

DEAN

SCHOOL OF AGRICULTURE

School of Agriculture
Ponnaiyah Ramajayam Institute of
Science & Technology (PRIST)
Institution Deemed to be University
3 of the UGC Act, 1956
THANJAVUR - 613 403, TAMIL NADU.



PRIST DEEMED TO BE UNIVERSITY SCHOOL OF AGRICULTURE

VALUE ADDED COURSE

Certificate of Appreciation



This is to certify that Ms/Mr T. YUVASREE

Reg.No. 2001BAG10205 has completed the Value Added Course

on KITCHEN GARDEN from _____

20.10.2023 to 25.01.2024 during the Academic year of 2023 to 2024

[Signature]
Course
coordinator

[Signature]
HOD

[Signature]
DEAN



PRIST DEEMED TO BE UNIVERSITY SCHOOL OF AGRICULTURE

VALUE ADDED COURSE

Certificate of Appreciation



This is to certify that Ms/Mr D. KUNARAJU

Reg.No. 21D1A010101 has completed the Value Added Course

on KITCHEN GARDEN from _____

20.10.2023 to 05.01.2024 during the Academic year of 2023 to 2024

[Signature]
Course
coordinator

[Signature]
HOD

[Signature]
DEAN



PRIST DEEMED TO BE UNIVERSITY SCHOOL OF AGRICULTURE

VALUE ADDED COURSE

Certificate of Appreciation



This is to certify that Ms/Mr _____

R. KABILANI

Reg.No. 2101A6110109 has completed the Value Added Course

on _____ from _____

03.01.2024 to 02.03.2024 during the Academic year of 2023 to 2024

Q.P. Jeyi
Course
coordinator

Jeyi
HOD

Jeyi
DEAN



PRIST DEEMED TO BE UNIVERSITY SCHOOL OF AGRICULTURE

VALUE ADDED COURSE

Certificate of Appreciation



This is to certify that **PRIST** Ms/Mr NISHA. J.

Reg.No. 21D1A0110204 has completed the Value Added Course

on _____ from _____

03.01.2024 to 02.03.2024 during the Academic year of 2023 to 2024

P. Praveen
Course
coordinator

for on
HOD

Year
DEAN



PRIST DEEMED TO BE UNIVERSITY SCHOOL OF AGRICULTURE

VALUE ADDED COURSE

Certificate of Appreciation



This is to certify that Ms/Mr A. ANANDHA KUMAR

Reg.No. 2101AG10113 has completed the Value Added Course

on "POST HARVEST TECHNOLOGY" from _____

19.03.24 to 17.04.24 during the Academic year of 2023 to 2024

D. Sobha
Course
coordinator

[Signature]
HOD

[Signature]
DEAN



PRIST DEEMED TO BE UNIVERSITY SCHOOL OF AGRICULTURE

VALUE ADDED COURSE

Certificate of Appreciation



This is to certify that **Ms/Mr** C. KOTHIRAVAN

Reg.No. 2201PK10108 has completed the Value Added Course

on "POST HARVEST TECHNOLOGY" from _____

19.02.24 to 17.04.24 during the Academic year of 2023 to 2024

D Sobika
Course
coordinator

Srinivas
HOD

Srinivas
DEAN



PRIST DEEMED TO BE UNIVERSITY SCHOOL OF AGRICULTURE

VALUE ADDED COURSE

Certificate of Appreciation



This is to certify that **PRIST** Ms/Mr J. NISHA
Reg.No. 2101A1410244 has completed the Value Added Course

on 16/8/23 to 18/10/23 during the Academic year of 2023 to 2024
from CONSERVATION AGRICULTURE

[Signature]
Course
coordinator

[Signature]
HOD

[Signature]
DEAN



PRIST DEEMED TO BE UNIVERSITY SCHOOL OF AGRICULTURE

VALUE ADDED COURSE

Certificate of Appreciation



This is to certify that Ms/Mr ELMATHESH ELMATHESH SATHAR.S
has completed the Value Added Course

Reg.No. 2001AFL10109 on COLLEGE OF AGRICULTURE from
16/10/23 to 18/10/23 during the Academic year of 2023 to 2024

[Signature]
Course
coordinator

[Signature]
HOD

[Signature]
DEAN



PRIST DEEMED TO BE UNIVERSITY SCHOOL OF AGRICULTURE

VALUE ADDED COURSE

Certificate of Appreciation



This is to certify that Ms/Mr T. Gopika
 Reg.No. 2001 N6 10203 has completed the Value Added Course
 on "Flit tech Nursery" from _____
 on 11-03-2024 to 29-04-2024 during the Academic year of 2023 to 2024



M. Jagan
 Course
 coordinator

Sham
 HOD

V
 DEAN



PRIST DEEMED TO BE UNIVERSITY SCHOOL OF AGRICULTURE VALUE ADDED COURSE

Certificate of Appreciation



This is to certify that Ms/Mr FKSHRPA.V
Reg.No. 21010610209 has completed the Value Added Course
on "TIT TECH INTERSECT" from

11.03.2024 to 29.04.2024 during the Academic year of 2023 to 2024

M. Jasmine
Course
coordinator

Sham
HOD

Veri
DEAN



**PONNAIYAH RAMAJAYAM INSTITUTE OF
SCIENCE & TECHNOLOGY (PRIST)**

Declared as DEEMED-TO-BE UNIVERSITY
U/s 3 of UGC Act, 1956

DEPARTMENT OF EDUCATION

SCHOOL OF EDUCATION

Value Added Course

2023 - 2024



PONNAIYAH RAMAJAYAM INSTITUTE OF SCIENCE & TECHNOLOGY (PRIST)

Declared as DEEMED-TO-BE-UNIVERSITY
U/s 3 of UGC Act, 1956

SCHOOL OF EDUCATION DEPARTMENT OF EDUCATION

Value Added Course

Circular

This is to inform all B.Ed & M.Ed Education students that the value added programme classes for academic year 2023 – 2024 will be commenced from 01.09.2023. Hence requesting all the registered without fail

S.No	Course Code	Course Offered	Branch Name	Year	Course
1	23130VAC1	General Awareness	Education	2023 - 24	B.Ed & M.Ed
2	23130VAC2	Mental Health	Education	2023 - 24	B.Ed & M.Ed
3	23130VAC3	Environmental Awareness	Education	2023 - 24	B.Ed & M.Ed
4	23130VAC4	Basics of laptop maintenance and OS installation	Education	2023 - 24	B.Ed & M.Ed
5	23130VAC5	Time management	Education	2023 - 24	B.Ed & M.Ed

HOD

HOD

School of Education
Ponnaiyah Ramajayam Institute of
Science & Technology (PRIST)
THANJAVUR - 613 403

Dean

DEAN

School of Education
Ponnaiyah Ramajayam Institute of
Science & Technology (PRIST)
THANJAVUR - 613 403



PONNAIYAH RAMAJAYAM INSTITUTE OF SCIENCE & TECHNOLOGY (PRIST)

Declared as DEEMED-TO-BE-UNIVERSITY
U/s 3 of UGC Act, 1956

SCHOOL OF EDUCATION

DEPARTMENT OF EDUCATION

Value Added Course

Details of Faculty for Value Added Course

S.No	Year	Duration	Name of the Faculty	Course Title	Number of Students
1	2023 - 2024	45 Hours	Dr.M.Aron Anthony Charles Dr. R.Gunasekaran	General Awareness	75
2	2023 - 2024	45 Hours	Dr.P.Subathra T. Selvaraj	Mental Health and Disorder	75
3	2023 - 2024	45 Hours	D.Arivumani R.Vaishnavi	Environmental awareness	75
4	2023 - 2024	45 Hours	Dr.V.Murugan F.Heme Jenita Mary	Basics of laptop maintenance and OS installation	75
5	2023 - 2024	45 Hours	Dr.K.B.Jasmin suthandira devi F.Heme Jenita Mary	Time management	75

HOD

HOD

School of Education
Ponnaiyah Ramajayam Institute of
Science & Technology (PRIST)
THANJAVUR - 613 403.

Dean

DEAN

School of Education
Ponnaiyah Ramajayam Institute of
Science & Technology (PRIST)
THANJAVUR - 613 403.



**SCHOOL OF EDUCATION
VALUE ADDED COURSE IN**

General Awareness

ABOUT PRIST DEEMED TO BE UNIVERSITY

- ❖ Established in the year 2000.
- ❖ Attained university status in the year 2008.
- ❖ Provides world class learning infrastructure.
- ❖ Offering quality higher Education in Engineering & Technology.
- ❖ Renching our Campus apart from Thanjavur, Madurai, Trichy, Pondichery, Kumbakonam & Chennai.

Our beloved patron Prof.P.Murugesan makes his humble contribution to society by providing quality education. He owes everything to his beloved father Shri.Ponnaiyah and his loving mother Shri.Ramajayalammal who inspired him, nurtured him and groomed him.

Our Ponnaiyah Ramajayam Institute of Science and Technology (PRIST) Institution, a Deemed to be University, Thanjavur, Tamil Nadu is recognized by UGC Under Section 3 of Act 1956, is one of the renowned institutions and it quality education serves more than 30 year in promoting.

PROFILE OF THE SCHOOL OF EDUCATION

The School of education under Ponnaiyah Ramajayam Institute of Science and Technology (PRIST) was established at Vallam, Thanjavur in the year 2008. The School of Education runs the full time B.Ed., M.Ed., M.Phil programmes and Full time / Part time Ph.D programmes to uplift the poor and marginal students. School of Education is contributing its best to promote research and to impart educational skills to the rural students and to bring out their latent talents in the mind of the rural students.

CERTIFICATE PROGRAMME IN GUIDANCE

The Certificate Programme in Guidance (CIG) caters to the needs of teachers, parents, social workers and others interested in guiding children in the age group of 5-11 years for their better learning and social-emotional development. This is an awareness programme, which will help you in dealing with the problems faced by the children. The programme is developed in collaboration with the National Council of

Educational Research and Training (NCERT), Delhi, the apex body concerned with school education in the country. **HOW WILL THIS PROGRAMME HELP YOU?**

The programme has been specially designed to help you develop understanding of child development. You will know

how individual differences play a vital role in the context of child education. You will know concepts and processes involved in guiding elementary school children for learning and socio-emotional development. You will be able to identify children with special needs and problems. This programme will suggest strategies to facilitate all round development of children.

TARGET GROUP

This programme is meant for a target group comprising teachers, parents, social workers, personnel from voluntary agencies or any individual who is interested in understanding and guiding children.

ELIGIBILITY

Teachers at pre-primary and primary schools. Anyone with 10th matriculation pass and minimum 18 years of age.

PROGRAMME STRUCTURE

National Health Programmes in India.

INSTRUCTIONAL SYSTEM

UNIT I Current Events of National and International Importance: Current social issues, Political issues, Economic issues, Business issues, International issues, Environmental issues, Sports issues. (Issues that took place between June to September of that academic year will be given more weightage)

UNIT II General and World Geography Natural Resources of the world: Earth in space – Atmosphere, Atmospheric moisture, climate, Hydrosphere, Lithosphere, Landforms – Continents and oceans, mountains, plateaus and plains, Internal and External forces of Earth Soils, Natural vegetation and wild life, Economic, Resources, Agriculture, Industry, Transport and communication, Continents, Important cities of the world.

UNIT III International Organizations United Nations Organizations, The Commonwealth, SAARC, ASEAN
UNIT IV Indian Geography Land forms, Drainage, climate, Natural vegetation and wild life, Natural Resources of India, Soils, Agriculture, Animal Husbandry and fishing, Mineral Resources, Energy, Industry, Transport and communication. The people, settlements and migration
UNIT V Economic and Social Development National income and structural change, Foreign Trade, Foreign capitals, Prices, Indian currency, Economy Development, Nature of Indian Economy, Social Demographics, poverty, Development Initiatives by the State/Central Government

HOD

School of Education
Ponnaiyah Ramajayam Institute of
Science & Technology (PRIST)
THANJAVUR - 613 403.

- Printed materials sent to you by post which you can easily read and understand on your own;
- Video and Audio programmes provided at the Study Centres;

- Programme telecast through massional book up of Door Darshan;
- Facility for further help for learning from the academic counsellors at the Study Centres;
- Feedback provided on written assignments and activity-oriented home assignments done by you;
- Live interaction between teachers at the Headquarters and students at Regional Centres through teleconferencing and radio counselling at select places.

EVALUATION

When you successfully complete all the courses mentioned above, you will be eligible for the award of Certificate in Guidance. There are three types of evaluation methods used under this programme.

- a) There are exercises in the printed learning material which you are required to do while study in gth class in gmatc hall (no weight age).
- b) There will be continuous examination in the form of assignments.
- c) There will be term-end (final) examination.
- d) The weight age given to the final and continuous assessment will be 70% and 30% respectively

DURATION

Minimum: 45 Hours
Maximum: 3 Months
PROGRAMME FEE-Rs. 100

MEDIUM OF INSTRUCTION: English

For more details of the programme please contact: The Dean

Or

The Programme Coordinator
Ponnaiyah Ramajayam Institute of Science & Technology (PRIST),

Deemed To Be University

Thanjavur, -613403.

Phone: 9443806804 Fax: +91 4362

250371

Web: www.prist.ac.in

Outlook Mail id: deamedu@prist.ac.in

E-Mail id: pristsoc@gmail.com



DEAN

School of Education
Ponnaiyah Ramajayam Institute of
Science & Technology (PRIST)
THANJAVUR - 613 403



PONNAIYAH RAMAJAYAM INSTITUTE OF
SCIENCE & TECHNOLOGY (PRIST)
PONDICHERRY CAMPUS
PONDICHERRY - 605 006

SCHOOL OF EDUCATION VALUE ADDED COURSE IN MENTAL HEALTH

- ABOUT PRIST DEEMED TO BE UNIVERSITY**
- ❖ Established in the year 2000.
 - ❖ Attained university status in the year 2008.
 - ❖ Provides world class learning infrastructure.
 - ❖ Offering quality higher Education in Engineering & Technology.
 - ❖ Reaching our Campus apart from Thanjavur, Madurai, Tiruchy, Pondichery, Kumbakonam & Chennai.

Our beloved patron Prof. P. Murugesan makes his humble contribution to society by providing quality education. He owes everything to his beloved father Shri. Ponnaiyah and his loving mother Shri. Ramajayamma who inspired him, nurtured him and groomed him.

Our Ponnaiyah Ramajayam Institute of Science and Technology (PRIST) Institution, a Deemed to be University, Thanjavur, Tamil Nadu is recognized by UGC Under Section 3 of Act 1956, is one of the renowned institutions and it quality education serves more than 30 year in promoting

PROFILE OF THE SCHOOL OF EDUCATION

The School of education under Ponnaiyah Ramajayam Institute of Science and Technology (PRIST) was established at Vallam, Thanjavur in the year 2008. The School of Education runs the full time B.Ed., M.Ed., M.Phil programmes and Full time / Part time Ph.D Programme to uplift the poor and marginal students. School of Education is contributing its best to promote research and to impart educational skills to the rural students and to bring out their latent talents in the mind of the rural students.

CERTIFICATE PROGRAMME IN GUIDANCE

The Certificate Programme in Guidance (CIG) caters to the needs of teachers, parents, social workers and others interested in guiding children in the age group of 5-11 years for their better learning and social-emotional development. This is an awareness programme, which will help you in dealing with the problems faced by the children. The programme is

developed in collaboration with the National Council of Educational Research and Training (NCERT), Delhi, the apex body concerned with school education in the country. **HOW WILL THIS PROGRAMME HELP YOU?**

The programme has been specially designed to help you develop understanding of child development. You will know

how individual differences play a vital role in the context of child's education. You will know concepts and processes involved in guiding elementary school children for learning and socio-emotional development. You will be able to identify children with special needs and problems. This programme will suggest strategies to facilitate all round development of children.

TARGET GROUP

This programme is meant for a target group comprising teachers, parents, social workers, personnel from voluntary agencies or any individual who is interested in understanding and guiding children.

ELIGIBILITY

Teachers at pre-primary and primary schools.

Anyone with 10 matriculation pass and minimum 18 years of age.

PROGRAMME STRUCTURE

National Health Programmes in India.

INSTRUCTIONAL SYSTEM

Unit – I Psychiatric Social Work: Basic concepts, scope, management and treatment for psychiatric disorders.

Unit – II Major Psychiatric and Psychotic disorders – Schizophrenia - Its types - Mood Disorder – Other Bipolar Disorders.

Unit – III Minor Psychiatric disorders – Anxiety disorder – Panic disorder – Phobias – Post Traumatic Stress.

Unit – IV Other Psychiatric Disorders – Personality Disorders – Sleep disorder – Speech disorder – Psychosomatic disorder – Suicide.

Unit – V Childhood Psychiatric disorders – Mental Retardation – Learning disorders – Developmental disorders – Autism – Attention Deficit Hyper activity. Psychiatric disorder affecting Women, Youth and aged – Elimination of disorders.

- Printed materials sent to you by post which you can easily read and understand on your own;
- Video and Audio programmes provided at the Study Centres;

- Programme is cast through national bookshop Door Darshan;
- Facility for further help for learning from the academic counsellors at the Study Centres;
- Feedback provided on written and activity-oriented assignments done by you;
- Live interaction between teachers at the Headquarters and students at Regional Centres through teleconferencing and radio counselling at select places.

EVALUATION

When you successfully complete all the courses mentioned above, you will be eligible for the award of Certificate in Guidance. There are three types of evaluation methods used under this programme.

- e) There are exercises in the printed learning material which you are required to do while study in the eleam in gmate rial (no weight age).
- f) There will be continuous examination in the form of assignments.
- g) There will be term-end (final) examination.
- h) The weight age given to the final and continuous assessment will be 70% and 30% respectively

DURATION

Minimum: 45 Hours
Maximum: 3 Months
PROGRAMME FEE: Rs. 100

MEDIUM OF INSTRUCTION: English

For more details of the programme please contact:
The Dean

Or

The Programme Coordinator
Ponnaiyah Ramajayam Institute of Science & Technology (PRIST),

Deemed To Be University

Thanjavur, -613403.

Phone: 9443806804 Fax: +91 4362

250371

Web: www.prist.ac.in

Outlook Mail id: deanedu@prist.ac.in

E-Mail id: pristsoc@gmail.com

PRIST
DEAN

School of Education
Ponnaiyah Ramajayam Institute of
Science & Technology (PRIST)
THANJAVUR - 613 403

School of Education
Ponnaiyah Ramajayam Institute of
Science & Technology (PRIST)
THANJAVUR - 613 403



**SCHOOL OF EDUCATION
VALUE ADDED COURSE IN
ENVIRONMENTAL
AWARENESS**

ABOUT PRIST DEEMED TO BE UNIVERSITY

- ❖ Established in the year 2000.
- ❖ Attained university status in the year 2008.
- ❖ Provides world class learning infrastructure.
- ❖ Offering quality higher Education in Engineering & Technology.
- ❖ Reaching our Campus apart from Thanjavur, Madurai, Trichy, Pondicherry, Kumbakonam & Chennai.

Our beloved patron Prof. P. Murgesan makes his humble contribution to society by providing quality education. He owes everything to his beloved father Shri. Ponnaiyah and his loving mother Shri. Ramajayamma who inspired him, nurtured him and groomed him.

Our Ponnaiyah Ramajayam Institute of Science and Technology (PRIST) Institution, a Deemed to be University, Thanjavur, Tamil Nadu is recognized by UGC Under Section 3 of Act 1956, is one of the renowned institutions and it quality education serves more than 30 year in promoting.

PROFILE OF THE SCHOOL OF EDUCATION

The School of education under Ponnaiyah Ramajayam Institute of Science and Technology (PRIST) was established at Vallam, Thanjavur in the year 2008. The School of Education runs full time B.Ed., M.Ed., M.Phil. programmes and Full time / Part time Ph.D. programmes to uplift the poor and marginal students. School of Education is contributing its best to promote research and to impart educational skills to the rural students and to bring out their latent talents in the mind of the rural students.

CERTIFICATE PROGRAMME IN GUIDANCE

The Certificate Programme in Guidance (CIG) caters to the needs of teachers, parents, social workers and others interested in guiding children in the age group of 5-11 years for their better learning and social-emotional development. This is an awareness programme, which will help you in dealing with the problems faced by the children. The programme is

developed in collaboration with the National Council of Educational Research and Training (NCERT), Delhi, the apex body concerned with school education in the country.

HOW WILL THIS PROGRAMME HELP YOU?

The programme has been specially designed to help you develop understanding of child development. You will know

how individual differences play a vital role in the context of child education. You will know concepts and processes involved in guiding elementary school children for learning socio-emotional development. You will be able to identify children with special needs and problems. This programme will suggest strategies to facilitate all round development of children.

TARGET GROUP

This programme is meant for a target group comprising teachers, parents, social workers, personnel from voluntary agencies or any individual who is interested in understanding and guiding children.

ELIGIBILITY

Teachers in pre-primary and primary schools.
Anyone with 10 matriculation pass and minimum 18 years of age.

PROGRAMME STRUCTURE

National Health Programme in India.

INSTRUCTIONAL SYSTEM

Unit-I: Introduction to Environmental Education Meaning and scope
- Importance of Environmental Education - incorporating EE at various levels- Primary, Secondary and Higher Secondary levels.
Education about environment Environment and Ecological factors - climate, Ecosystems - Structure and functions - Major ecosystems - aquatic and terrestrial system - Energy and its flow in ecosystems.

Unit-II: Environmental problems and protection Environmental pollution and its consequences - Air pollution, water pollution, land pollution, nuclear pollution, Ozone depletion - Urbanization and its impacts on environment - Deforestation and its impacts on environment - Ways of protecting, Management of Environment, Preserving and Restoring of environment.

Unit-III: India and Environmental Issues and Policies Environmental Awareness - Environmental problems of India - Environmental ethics - Nature conservation education movement - Social forestry scheme. Conservation of biodiversity. Meanings and need conservation of natural resources - soil, forest, water and wildlife In-situ conservation - National parks and sanctuaries - Biosphere Reserves - Man and Biosphere programme (MAB) - Ex - situ conservation, in - situ conservation, IUCN Red list categories, hot spots.

Unit-IV: Human population and environment Population growth, Indian population situations population explosion - family welfare programme - Environment and Human health - Factors affecting environment - Acid rain, green house effect - Extinction of species - soil erosion and energy crisis.

Unit-V: International Efforts for Environmental Protection The Stockholm conference 1972 - Brundtland commission 1983 - Nairobi conference 1982 - The Rio Summit 1992 - the Rio Declaration at the earth charter - Major achievement of the Rio Summit - Main features of the Rio Declaration - Kyoto conference and part on Global Warming 1997 - present developments

- Printed material is sent to you by post which, you can easily read and understand on your own;
- Videos and Audio programmes provided at the Study Centres;
- Programme is telecast through national hook up of Doordarshan;
- Facility for further help for learning from the academic counsellors at the Study Centres;
- Feedback provided on written and activity-oriented home assignments done by you;
- Live interaction between teachers at the Headquarters and students at Regional Centres through teleconferencing and radio counselling at select places.

EVALUATION

When you successfully complete all the courses mentioned above, you will be eligible for the award of Certificate in Guidance. There are three types of evaluation methods used under this programme.

- i) There are exercises in the printed learning material which you are required to do while study in the class in your own time (no weight age).
- ii) There will be continuous examination in the form of assignments.
- iii) There will be term-end (final) examination.
- iv) The weight age given to the final and continuous assessment will be 70% and 30% respectively.

DURATION

Minimum: 45 Hours
Maximum: 3 Months PROGRAMME FEE: Rs. 100
MEDIUM OF INSTRUCTION: English

For more details of the programme please contact:

The Dean

Or

The Programme Coordinator

Ponnaiyah Ramajayam Institute of Science & Technology (PRIST),

Deemed To Be University

Thanjavur, -613403.

Phone: 9443806804 Fax: +91 4362

250371

Web: www.prist.ac.in

Outlook Mail id: deanedu@prist.ac.in

E-Mail id: pristsoe@gmail.com



DEAN



PONNAIYAH RAMAJAYAM INSTITUTE OF
SCIENCE & TECHNOLOGY (PRIST)
PONDICHERRY - 605 006

SCHOOL OF EDUCATION VALUE ADDED COURSE IN BASICS OF LAPTOP MAINTANANCE AND OS INSTALLATION

ABOUT PRIST DEEMED TO BE UNIVERSITY

- ❖ Established in the year 2000.
- ❖ Attained university status in the year 2008.
- ❖ Provides world class learning infrastructure.
- ❖ Offering quality higher Education in Engineering & Technology.
- ❖ Reaching our Campus apart from Thanjavur, Madurai, Trichy, Pondichery, Kumbakonam & Chennai.

Our beloved patron Prof. P. Murugesan makes his humble contribution to society by providing quality education. He owes everything to his beloved father Shri. Ponnaiah and his loving mother Shri. Ramajayamma who inspired him, nurtured him and groomed him.

Our Ponnaiyah Ramajayam Institute of Science and Technology (PRIST) Institution, a Deemed to be University, Thanjavur, Tamil Nadu is recognized by UGC Under Section 3 of Act 1956, is one of the renowned institutions and it quality education serves more than 30 year in promoting.

PROFILE OF THE SCHOOL OF EDUCATION:

The School of education under Ponnaiyah Ramajayam Institute of Science and Technology (PRIST) was established at Vallam, Thanjavur in the year 2008. The School of Education runs the full time B.Ed., M.Ed., M.Phil programmes and Full time / Part time Ph.D Programme to uplift the poor and marginal students. School of Education is contributing its best to promote research and to impart educational skills to the rural students and to bring out their latent talents in the mind of the rural students.

CERTIFICATE GUIDANCE PROGRAMME IN

The Certificate Programme in Guidance (C/G) caters to the needs of teachers, parents, social workers and others interested in guiding children in the age group of 5-11 years for their better learning and social-emotional development. This is an

awareness programme, which will help you in dealing with the problems faced by the children. The programme is developed in collaboration with the National Council of Educational Research and Training (NCERT), Delhi, the apex body concerned with school education in the country.

HOW WILL THIS PROGRAMME HELP YOU?

The programme has been specially designed to help you develop understanding of child development. You will know how individual differences play a vital role in the context of child education. You will know concepts and processes involved in guiding elementary school children for learning and socio-emotional development. You will be able to identify children with special needs and problems. This programme will suggest strategies to facilitate all round development of children.

TARGET GROUP

This programme is meant for a target group comprising teachers, parents, social workers, personnel from voluntary agencies or any individual who is interested in understanding and guiding children.

ELIGIBILITY

Teachers in pre-primary and primary schools.

Anyone with 10th matriculation pass and minimum 18 years of age.

PROGRAMME STRUCTURE

National Health Programmes in India.

INSTRUCTIONAL SYSTEM

Unit: I

The Essentials of a computer and its components Laptop Expansion options.

Unit: II

Various motherboard technologies and identify important motherboard parts. Configuration changes to a computer.

Unit: III

Plan for a memory installation or upgrade- configuring windows operating systems.

Unit: IV

Wi-Fi and windows Networks hardware parts that connect to different part of a computer and laptop

Unit: V

Basic troubleshooting – Install, configure and troubleshoot Windows, Android, and OS operating systems.

- Prerequisite is sentry you by post which you

- can easily read and understand on your own;
- Videos and Audio programmes provided at the Study Centres;
- Programme fees as through an online portal through a Doordarshan;
- Facility for further help for learning from the academic counsellors at the Study Centres;
- Feedback provided on written and activity-oriented home assignments done by you;
- Live interaction between teachers at the Head quarters and students at Regional Centres through teleconferencing and audio counselling at select places.

EVALUATION

When you successfully complete all the courses mentioned above, you will be eligible for the award of Certificate in Guidance. There are three types of evaluation methods used under this programme.

- m) There are exercises in the printed learning material which you are required to do while studying in the clear in game trial (no weight age).
- n) There will be continuous examination in the form of assignments.
- o) There will be term-end (final) examination.
- p) The weight age given to the final and continuous assessment will be 70% and 30% respectively.

DURATION

Minimum: 45 Hours

Maximum: 3 Months PROGRAMME FEE: Rs. 100

MEDIUM OF INSTRUCTION: English

For more details of the programme please contact:

The Dean

Or

The Programme Coordinator

Ponnaiyah Ramajayam Institute of Science & Technology (PRIST),

Deemed To Be University

Thanjavur, -613403.

Phone: 9443806804 Fax: +91 4362

250371

Web: www.prist.ac.in

Outlook Mail id: deantebs@prist.ac.in

E-Mail id: pristsoe@gmail.com



DEAN

School of Education

Ponnaiyah Ramajayam Institute of

Science & Technology (PRIST)

THANJAVUR - 613 403

School of Education

Ponnaiyah Ramajayam Institute of

Science & Technology (PRIST)

THANJAVUR - 613 403



PONNAIYAH RAMAJAYAM INSTITUTE OF
SCIENCE & TECHNOLOGY (PRIST)
ESTABLISHED IN THE YEAR 2008
100, PONDICHERRY - 605 006

SCHOOL OF EDUCATION VALUE ADDED COURSE IN

TIME MANAGEMENT

ABOUT PRIST DEEMED TO BE UNIVERSITY

- ❖ Established in the year 2008.
- ❖ Attained university status in the year 2008.
- ❖ Provides world class learning infrastructure.
- ❖ Offering quality higher Education in Engineering & Technology.
- ❖ Reaching our Campus apart from Thanjavur, Madurai, Trichy, Pondichery, Kumbakonam & Chennai.

Our beloved patron Prof.P.Murugesan makes his humble contribution to society by providing quality education. He owes everything to his beloved father Shri.Ponnaiah and his loving mother Shri.Ramajayanthammal who inspired him, nurtured him and groomed him.

Our Ponnaiyah Ramajayam Institute of Science and Technology (PRIST) Institution, a Deemed to be University, Thanjavur, Tamil Nadu is recognized by UGC Under Section 3 of Act 1956, is one of the renowned institutions and it quality education serves more than 30 year in promoting.

PROFILE OF THE SCHOOL OF EDUCATION

The School of education under Ponnaiyah Ramajayam Institute of Science and Technology (PRIST) was established at Vallam, Thanjavur in the year 2008. The School of Education runs the full time B.Ed., M.Ed., M.Phil programmes and Full time / Part time Ph.D Programme to uplift the poor and marginal students. School of Education is contributing its best to promote research and to impart educational skills to the rural students and to bring out their latent talents in the mind of the rural students

CERTIFICATE PROGRAMME IN GUIDANCE

The Certificate Programme in Guidance (CIG) caters to the needs of teachers, parents, social workers and others interested in guiding children in the age group of 5-11 years for their better learning and social-emotional development. This is an

awareness programme, which will help you in dealing with

the problems faced by the children. The programme is developed in collaboration with the National Council of Educational Research and Training (NCERT), Delhi, the apex body concerned with school education in the country.

HOW WILL THIS PROGRAMME HELP YOU?

The programme has been specially designed to help you develop understanding of child development. You will know how individual differences play a vital role in the context of child education. You will know concepts and processes involved in guiding elementary school children for learning and socio-emotional development. You will be able to identify children with special needs and problems. This programme will suggest strategies to facilitate all round development of children.

TARGET GROUP

This programme is meant for a target group comprising teachers, parents, social workers, personnel from voluntary agencies or any individual who is interested in understanding and guiding children.

ELIGIBILITY

Teachers at pre-primary and primary schools.

Anyone with 10th matriculation pass and minimum 18 years of age.

PROGRAMME STRUCTURE

National Health Programme in India.

INSTRUCTIONAL SYSTEM

Unit I: Introduction to Time Management

Definition, Goals, Objectives and principles of time

management, Importance and benefits of time management

Unit II: Time management Process and Procrastination,

Costing time, Goal setting, Planning, Scheduling

Strategies to prevent procrastination

Unit III: Time Management Mistakes, Time

wasters, Myths of time management, Common time

management mistakes, Detecting difficulties, Symptoms of

poor time management

Unit IV: Strategies for students, Benefits of time

management, Management tips for students

Time management grid, Working smarter to enhance

productivity

Unit V: Best Practices of time management, Practicum

/Activities, Group Activities, Quiz and Individual Task

- Printed materials sent to you by post which you can easily read and understand on your own;
- Video and Audio programmes provided at the Study Centres;
- Programme materials brought through national bookshop Doorstep;
- Facility for further help for learning from the academic counsellors at the Study Centres;
- Feedback provided on written assignments and activity-oriented homework assignments done by you;
- Live interaction between teachers at the Headquarters and students at Regional Centres through teleconferencing and audio counselling at select places.

EVALUATION

When you successfully complete all the courses mentioned above, you will be eligible for the award of Certificate in Guidance. There are three types of evaluation methods used under this programme.

- q) There are exercises in the printed learning material which you are required to do while studying in the classroom in group (no weightage).
- r) There will be continuous examination in the form of assignments.
- s) There will be term-end (final) examination.
- t) The weightage given to the final and continuous assessment will be 70% and 30% respectively

DURATION

Minimum: 45 Hours

Maximum: 3 Months PROGRAMME FEE: Rs. 100

MEDIUM OF INSTRUCTION: English

For more details of the programme please contact:

The Dean

Or

The Programme Coordinator

Ponnaiyah Ramajayam Institute of Science & Technology

(PRIST),

Deemed To Be University

Thanjavur, -613403.

Phone: 9443806804 Fax: +91 4362

250371

Web: www.prist.ac.in

Outlook Mail id: deancdu@prist.ac.in

E-Mail id: pristsoe@gmail.com



DEAN

School of Education

Ponnaiyah Ramajayam Institute of

Science & Technology (PRIST)

THANJAVUR - 613 403.



HOD

School of Education

Ponnaiyah Ramajayam Institute of

Science & Technology (PRIST)

PONNAIYAH RAMAJAYAM INSTITUTE OF SCIENCE & TECHNOLOGY (PRIST)
SCHOOL OF EDUCATION
VALUE ADDED COURSE
COURSE CODE:23I30VAC01- GENERAL AWARENESS

OBJECTIVES

- To enable the students have a thorough understanding of the various important issues of National and international relevance
- To motivate the students to prepare for competitive exams
- To enable the students to have an overall view of the society in which they live.

UNIT I Current Events of National and International Importance Current social issues, Political issues, Economic issues, Business issues, International issues, Environmental issues, Sports issues, (Issues that took place between June to September of that academic year will be given more weight age)

UNIT II General and World Geography Natural Resources of the world: Earth in space – Atmosphere, Atmospheric moisture, climate, Hydrosphere, Lithosphere, Landforms – Continents and oceans, mountains, plateaus and plains, Internal and External forces of Earth. Soils, Natural vegetation and wild life, Economic, Resources, Agriculture, Industry, Transport and communication, Continents, Important cities of the world.

UNIT III International Organizations United Nations Organizations, The Commonwealth, SAARC, ASEAN

UNIT IV Indian Geography Land forms, Drainage, climate, Natural vegetation and wild life, Natural Resources of India, Soils, Agriculture, Animal Husbandry and fishing, Mineral Resources, Energy, Industry, Transport and communication., The people, settlements and migration

UNIT V Economic and Social Development National income and structural change, Foreign Trade, Foreign capitals, Prices, Indian currency, Economy Development, Nature of Indian Economy, Social Demographics, poverty, Development Initiatives by the State/Central Government

OUTCOMES:

- Enable the students have a thorough understanding of the various important issues of National and international relevance
- Motivate the students to prepare for competitive exams
- Enable the students to have an overall view of the society in which they live.

Reference Books:

- Kosut.Marry (2012) Encyclopedia of Gender in media, New Delhi. Sage Publications’.
- Carole Brugeiles & Sylvie Cromer (2009) Promoting Gender Equality through Text books Paris UNESCO Publications division.
- Byerly C.M 2011. Global Report on the status of women in the News media, Washihgtan DC. International Women’s Media foundation.
- Fredrick Luie Aldama (2005) Brown on Brown Chilapola representations of gender. Sexuality and Ethnicity University of Texas press.

HOD

School of Education
Ponnaiyah Ramajayam Institute of
Science & Technology (PRIST)
THANJAVUR - 613 403.

DEAN

School of Education
Ponnaiyah Ramajayam Institute of
Science & Technology (PRIST)
THANJAVUR - 613 403

PONNAIYAH RAMAJAYAM INSTITUTE OF SCIENCE & TECHNOLOGY (PRIST)
SCHOOL OF EDUCATION
VALUE ADDED COURSE
COURSE CODE: 23130VAC02 - MENTAL HEALTH

Objectives

- To expose the students to the knowledge and skills of psychiatric social work
- To make the students understand the psychiatric disorders of child, youth and women
- To enable the students aware of coping strategies for psychiatric problems.

Unit – I Psychiatric Social Work: Basic concepts, scope, management and treatment for psychiatric disorders.

Unit – II Major Psychiatric and Psychotic disorders –Schizophrenia - Its types - Mood Disorder – Other Bipolar Disorders.

Unit – III Minor Psychiatric disorders – Anxiety disorder – Panic disorder – Phobias – Post Traumatic Stress.

Unit – IV Other Psychiatric Disorders – Personality Disorders – Sleep disorder – Speech disorder - Psychosomatic disorder – Suicide.

Unit – V Childhood Psychiatric disorders – Mental Retardation – Learning disorders – Developmental disorders - Autism – Attention Deficit Hyper activity. Psychiatric disorder affecting Women, Youth and aged – Elimination of disorders.

TEXT BOOKS

Mane, F. and Gandevia, K., Mental Health in Indian Issues and Concerns(eds.), Mumbai, Tata Institute of Social Sciences, 1993.

Sonia Austrian, Mental Disorders, Medications and Clinical Social Work,Columbia: Columbia University Press, 2005.

SUPPLEMENTARY READINGS

American Psychiatric ASSN, Diagnostic Criterion from DSM-IV American Psychiatric ASSN, 1994.

Berrios, G.E. and Dawson, J.H. Treatment and Management in Adult, Bailliere Tindal, London, 1983.

Nina Rovinelli Heller, Mental Health and Social Problems, New Delhi, Rutledge: 2010.

Kappur, M. Sheppard, Ralph and Renate, Child Mental Health-Proceedings of the Indo-US Symposium, eds, NIMHANS and ADAMHA, 1993

World Health Organisation, Geneva, The ICD 10 classification of Mental and

HOD

School of Education
Ponnaiyah Ramajayam Institute of
Science & Technology (PRIST)
THANJAVUR - 613 023

DEAN

School of Education
Ponnaiyah Ramajayam Institute of
Science & Technology (PRIST)
THANJAVUR - 613 023

Behavioural Disorders, Clinical Description and Diagnostic Guidelines, New Delhi: Oxford University Press, 1992.

Course Outcomes

Upon completion of the course the students will

- Know the history, scope and changing perspectives of psychiatric problems.
- Understand the various types of psychiatric problems and their treatment
- Gain knowledge on modern treatment for psychiatric disorders.
- Comprehend the role of psychosomatic disorder in mental illness.

HOD

School of Education
Ponnaiyah Ramajayam Institute of
Science & Technology (PRIST)
THANJAVUR - 613 403.

DEAN

School of Education
Ponnaiyah Ramajayam Institute of
Science & Technology (PRIST)
THANJAVUR - 613 403.

PONNAIYAH RAMAJAYAM INSTITUTE OF SCIENCE & TECHNOLOGY (PRIST)
SCHOOL OF EDUCATION
VALUE ADDED COURSE
COURSE CODE: 23130VAC03 - ENVIRONMENTAL AWARENESS

OBJECTIVES

- To understand the concept of environment ecology and Education.
- To grasp the significance of environmental education.
- To understand the nature and scope of environmental education with regard to Indian policies.
- To have faith in conservation of bio-diversity and understand population and environment.
- To understand the international effort and environment.

Unit-I: Introduction to Environmental Education Meaning and scope – Importance of Environmental Education - incorporating E.E at various levels- Primary, Secondary and Higher Secondary levels. Education about environment: Environment and Ecological factors – climate; Ecosystem – Structure and functions - Major ecosystems – aquatic and terrestrial system - Energy and its flow in ecosystem.

Unit-II: Environmental problems and protection Environmental pollution and its consequences – Air pollution, water pollution, land pollution, nuclear pollution, Ozone depletions - Urbanization and its impacts on environment - Deforestation and its impacts on environment – Ways of protecting, Management of Environment, Preserving and Restoring of environment.

Unit-III: India and Environmental Issues and Policies Environmental Awareness – Environmental problems of India - Environmental ethics - Nature conservation education movement – Social forestry scheme. Conservation of biodiversity :Meanings and need conservation of natural resources – soil, forest, water and wildlife In-situ conservation -National parks and sanctuaries – Biosphere Reserves –Man and Biosphere programme (MAP) –Ex -situ conservation, in -situ conservation, IUCN Red list categories, hot spots.

Unit-IV: Human population and environment Population growth, Indian population situations population explosion – family welfare programme – Environment and Human health.-Factors affecting environment-Acid rain, green house effect-Extinction of species-soil erosion and energy crisis.

Unit-V: International Efforts for Environmental Protection The Stockholm conference 1972 – Brundtland commission 1983 – Nairobi conference 1982 – The Rio Summit 1992 – the Rio Declaration at the earth charter – Major achievement of the Rio Summit – Main features of the Rio Declaration – Kyoto conference and part on Global Warming 1997 – present developments.

HOD

School of Education
Ponnaiyah Ramajayam Institute of
Science & Technology (PRIST)
THANJAVUR - 613 403

DEAN

School of Education
Ponnaiyah Ramajayam Institute of
Science & Technology (PRIST)
THANJAVUR - 613 403.

OUTCOMES:

- Discussion on the need and importance of protecting the environment
- Seminar on environmental awareness and environmental attitude
- Teacher talk on the need and importance of protecting water resources
- Preparation of a scrap book on issues related to environment
- Power point presentation on different types of environmental pollutions and its causes

REFERENCE BOOKS

- Archana, T. (2011). Environmental education. Kalpaz Publications.
- Havilah, S. N. (2013). Environmental education. A.P.H. Publishing Corporation.
- Maria, C. M. (2020). Effect of ecological intelligence on developing ecological sensitivity among prospective teachers. Shashwat Publication.
- Paachuri, S.C., & Kumar, P. (2013). Environmental education. A.P.H. Publishing Corporation.
- Palmer, J.A. (1998). Environmental education in the 21st Century: Theory, practice, progress, and promise. Routledge.

HOD
School of Education
Ponnaiyah Ramajayam Institute of
Science & Technology (PRIST)
THANJAVUR - 613 403

DEAN
School of Education
Ponnaiyah Ramajayam Institute of
Science & Technology (PRIST)
THANJAVUR - 613 403.

PONNAIYAH RAMAJAYAM INSTITUTE OF SCIENCE & TECHNOLOGY (PRIST)
SCHOOL OF EDUCATION
VALUE ADDED COURSE

COURSE CODE: 23130VAC04 - BASICS OF LAPTOP MAINTANANCE AND OS INSTALLATION

Objectives:

To describe the social and professional impact and importance of technology

Identify career opportunities related to technology

Unit: I

The Essentials of a computer and its components Laptop Expansion options.

Unit: II

Various motherboard technologies and identify important motherboard parts. Configuration changes to a computer.

Unit: III

Plan for a memory installation or upgrade- configuring windows operating systems.

Unit: IV

Wi-Fi and windows Networks hardware parts that connect to different port of a computer and laptop

Unit: V

Basic troubleshooting – Install, configure, and troubleshoot Windows, Android, and OS operating systems.

OUTCOMES:

- Application of any laptop technique
- Preparation of digital networks for power point presentation
- Develop a Blog of your own and add it in online
- Visit any one IT centre and prepare the report
- Setting of the apparatus for any one experiment in the laboratory and demonstrating the same

REFERENCES:

- Balagursamy, *Programming in Basic*, THN, Delhi.
- Aggarwal J.C., (2000) Principles, Methods and Techniques of Teaching, Vikas Publishing House Pvt. Ltd.,
- Malvino, Digital Computer Electronics, TMH, Delhi.
- Krishna Sagar, (2005) ICTs and teacher training, Delhi: Tarum offset.
- Harley, H.K. (2007). The internet: complete reference. New Delhi: Tata McGraw Hill, pub.co. Ltd.
- Goel, H.K (2007). Teaching of computer science. New Delh?: R.Lall Books
- Brandwein Paul, F. (1955). The Gifted as Future Scientist, New York, Earcourt Deace and Falvery, P., Holbrook, J., Conian, D. (1994). Assessing Students, Longmans Publications, Foundation by Longmans, Penguin Books.
- Williams, B., (1999). Internet for Teachers, John Wiley & Sons, U.S.A. World Inc.
- Sharma, R.A. (2008). Technological foundation of education. Meerut: R.Lall Books Depot.



HOD

School of Education
Ponnaiyah Ramajayam Institute of
Science & Technology (PRIST)
THANJAVUR - 613 403.



DEAN

School of Education
Ponnaiyah Ramajayam Institute of
Science & Technology (PRIST)
THANJAVUR - 613 403.

PONNAIYAH RAMAJAYAM INSTITUTE OF SCIENCE & TECHNOLOGY (PRIST)
SCHOOL OF EDUCATION
VALUE ADDED COURSE
COURSE CODE: 23130VAC05 - TIME MANAGEMENT

OBJECTIVE:

At the end of the course the students will be able to demonstrate an understanding on

- Introduction, definition and objectives of time management.
- Importance of time management
- Process of time management, tips and strategies.
- Benefits of time management
- Scientific narratives on effective use of time management
- Detecting difficulties in managing time.
- Procrastination and strategies to prevent it.
- Planning time and best practices of time management.

Unit I: Introduction to Time Management

Definition, Goals, Objectives and principles of time management, Importance and benefits of time management

Unit II: Time management Process and Procrastination, Costing time, Goal setting, Planning, Scheduling

Strategies to prevent procrastination

Unit III: Time Management Mistakes, Time wasters, Myths of time management, Common time management mistakes, Detecting difficulties, Symptoms of poor time management

Unit IV: Strategies for students, Benefits of time management, Management tips for students
Time management grid, Working smarter to enhance productivity

Unit V: Best Practices of time management, Practicum /Activities, Group Activities, Quiz and Individual Task.

Course Outcome:

At the end of the course the students will be able to:

Demonstrate skill in setting goals for themselves.

Demonstrate skill in planning of their time.

Adopt strategies for time management.

REFERENCE BOOK :

Books: Mancini M. Time Management. United States of America. The McGraw-Hill Companies

Research Journals (indexed):

Khan IA. Time management practices used by secondary school heads in Khyber Pakhtunkhwa. Gomal University, DI Khan 2017.

Wilson, R., Joiner, K., & Abbasi, A. (2021). Improving students' performance with time management skills. Journal of University Teaching & Learning Practice, 18(4).

<https://ro.uow.edu.au/jutlp/vol18/iss4/16>

Romero-Pérez, C., & Sánchez-Lissen, E. (2022). Scientific Narratives in the Study of Student Time Management: A Critical Review. International and Multidisciplinary Journal of Social Sciences, 11(2), 60-86. <https://doi.org/10.17583/rimcis.10322>

<https://tokyo.globalindianschool.org/blog/importance-of-time-management-to-students>

Alyami A, Abdulwahed A, Azhar A, Binsaddik A, Bafaraj SM. Impact of Time- Management on the Student's Academic Performance: A Cross-Sectional Study. Creative Education. 2021 March 4; 12 (3) : 471-485

<https://www.simplilearn.com/tutorials/time-management-tutorial/best-time-management-tips-for-students>



HOD

School of Education
Ponnaiyah Ramajayam Institute of
Science & Technology (PRIST)
THANJAVUR - 613 403



DEAN

School of Education
Ponnaiyah Ramajayam Institute of
Science & Technology (PRIST)
THANJAVUR - 613 403



**PONNAIYAH RAMAJAYAM INSTITUTE OF
SCIENCE & TECHNOLOGY (PRIST)**

Declared as DEEMED-TO-BE UNIVERSITY
Uts 3 of UGC Act, 1956

SCHOOL OF EDUCATION
Value Added Course
COURSE TITLE: GENERAL AWARENESS COURSE
Students Attendance Date: (September - 2023)
Academic Year 2023 - 2024

S.No	Reg.No	Name	07	08	09	10	11	12	13	14	16	18	19	20	23	24	27
1.	2302E DTA10 201	MATHAVI.R	X	X	X	X	X	X	X	X	X	X	X	X	X	X	X
2.	2302E DEN10 101	SUKENDRAN.R	X	X	X	X	X	X	X	X	X	X	X	X	X	X	X
3.	230ED MA102 01	KOWSALYA.M	X	X	X	X	X	X	X	X	X	X	X	X	X	X	X
4.	2301E DMA1 0202	KARTHIKA.K	X	X	X	X	X	X	X	X	X	X	X	X	X	X	X
5.	2302E DMA1 0203	UMA.K	X	X	X	X	X	X	X	X	X	X	X	X	X	X	X
6.	2302E DMA1 0204	YAMUNA.M	X	X	X	X	X	X	X	X	X	X	X	X	X	X	X
7.	2302E DPC10 201	SIMRAN.E	X	X	X	X	X	X	X	X	X	X	X	X	X	X	X
8.	2302E DPC10 202	BABY SHALINI.L	X	X	X	X	X	X	X	X	X	X	X	X	X	X	X
9.	2302E DPC10 203	HEMA.G	X	X	X	X	X	X	X	X	X	X	X	X	X	X	X
10.	2302E DPC10 204	GOWSALYA.G	X	X	X	X	X	X	X	X	X	X	X	X	X	X	X
11.	2302E DPC10 205	ANUSUYA.D	X	X	X	X	X	X	X	X	X	X	X	X	X	X	X
12.	2302E DPC10 101	AMALRAJ. B	X	X	X	X	X	X	X	X	X	X	X	X	X	X	X
13.	2302E DBS10 201	PARIMALA.S	X	X	X	X	X	X	X	X	X	X	X	X	X	X	X
14.	2302E DBS10 202	PRIYADHARSH INLP	X	X	X	X	X	X	X	X	X	X	X	X	X	X	X

HOD

School of Education
Ponnaiyah Ramajayam Institute of
Science & Technology (PRIST)
THANJAVUR - 613 403

DEAN

School of Education
Ponnaiyah Ramajayam Institute of
Science & Technology (PRIST)
THANJAVUR - 613 403

15.	2301E DCS10 201	PRADEEPA.R	X	X	X	X	X	X	X	X	X	X	X	X	X	X	X	X
16.	2301E DCS10 101	KARTHIK. M	X	X	X	X	X	X	X	X	X	X	X	X	X	X	X	X
17.	2302E DCO10 201	VEENA.P	X	X	X	X	X	X	X	X	X	X	X	X	X	X	X	X
18.	2302E DHI10 201	JAYANTHLD	X	X	X	X	X	X	X	X	X	X	X	X	X	X	X	X
19.	2302E DGO10 201	ABIRAMASUN DHARLS	X	X	X	X	X	X	X	X	X	X	X	X	X	X	X	X
20.	2302E DTA10 202	C.Amaravathi	X	X	X	X	X	X	X	X	X	X	X	X	X	X	X	X
21.	2302E DTA10 203	S.Anandhi	X	X	X	X	X	X	X	X	X	X	X	X	X	X	X	X
22.	2302E DTA10 204	N.Buveneswari	X	X	X	X	X	X	X	X	X	X	X	X	X	X	X	X
23.	2302E DTA10 205	S.Juliet	X	X	X	X	X	X	X	X	X	X	X	X	X	X	X	X
24.	2302E DTA10 206	S.Jenifar	X	X	X	X	X	X	X	X	X	X	X	X	X	X	X	X
25.	2302E DTA10 207	X.Arockiya Mary	X	X	X	X	X	X	X	X	X	X	X	X	X	X	X	X
26.	2302E DTA10 208	R.Darathy	X	X	X	X	X	X	X	X	X	X	X	X	X	X	X	X
27.	2302E DTA10 209	B.Muthulakshmi	X	X	X	X	X	X	X	X	X	X	X	X	X	X	X	X
28.	2302E DEN10 102	S.Sumitra	X	X	X	X	X	X	X	X	X	X	X	X	X	X	X	X
29.	2302E DEN10 103	D.Vasumathi	X	X	X	X	X	X	X	X	X	X	X	X	X	X	X	X
30.	2302E DEN10 104	S.Divya	X	X	X	X	X	X	X	X	X	X	X	X	X	X	X	X
31.	2302E DEN10 105	V.Chitra	X	X	X	X	X	X	X	X	X	X	X	X	X	X	X	X

HOD

School of Education
Ponnaiyah Ramajayam Institute of
Science & Technology (PRIST)
THANJAVUR - 613 403.

DEAN

School of Education
Ponnaiyah Ramajayam Institute
Science & Technology (PRIST)
THANJAVUR - 613 403.

32.	2302E DEN10 106	G.Nandhini	X	X	X	X	X	X	X	X	X	X	X	X	X	X	X	X
33.	2302E DEN10 107	J.Revathi	X	X	X	X	X	X	X	X	X	X	X	X	X	X	X	X
34.	2302E DEN10 108	J.Sangeetha	X	X	X	X	X	X	X	X	X	X	X	X	X	X	X	X
35.	2302E DEN10 109	T.Sasireka	X	X	X	X	X	X	X	X	X	X	X	X	X	X	X	X
36.	2302E DEN10 110	G.Lakshmi	X	X	X	X	X	X	X	X	X	X	X	X	X	X	X	X
37.	2302E DEN10 111	T.Sutha	X	X	X	X	X	X	X	X	X	X	X	X	X	X	X	X
38.	2302E DEN10 112	T.Indira	X	X	X	X	X	X	X	X	X	X	X	X	X	X	X	X
39.	230ED MA102 02	M.Krishnaveni	X	X	X	X	X	X	X	X	X	X	X	X	X	X	X	X
40.	230ED MA102 03	G.Regavathi	X	X	X	X	X	X	X	X	X	X	X	X	X	X	X	X
41.	230ED MA102 04	H. Jahabar Nachiya	X	X	X	X	X	X	X	X	X	X	X	X	X	X	X	X
42.	230ED MA102 05	V. Kiruba	X	X	X	X	X	X	X	X	X	X	X	X	X	X	X	X
43.	230ED MA102 06	K.Ambika	X	X	X	X	X	X	X	X	X	X	X	X	X	X	X	X
44.	230ED MA102 07	L.Angelomary	X	X	X	X	X	X	X	X	X	X	X	X	X	X	X	X
45.	230ED MA102 02	G.Saranya	X	X	X	X	X	X	X	X	X	X	X	X	X	X	X	X
46.	230ED MA102 03	R.Amuthakumari	X	X	X	X	X	X	X	X	X	X	X	X	X	X	X	X
47.	2302E DBS10 204	R.Kalaivani	X	X	X	X	X	X	X	X	X	X	X	X	X	X	X	X
48.	2302E DBS10 205	P.Kanmani	X	X	X	X	X	X	X	X	X	X	X	X	X	X	X	X



HOD

School of Education
Ponnaiyah Ramajayam Institute of
Science & Technology (PRIST)
THANJAVUR - 613 403.



DEAN

School of Education
Ponnaiyah Ramajayam Institute of
Science & Technology (PRIST)
THANJAVUR - 613 403.

49.	2302E DBS10 206	T.Meena	X	X	X	X	X	X	X	X	X	X	X	X	X	X	X	X
50.	2302E DBS10 207	K.Sathiyapriya	X	X	X	X	X	X	X	X	X	X	X	X	X	X	X	X
51.	2302M ED202 01	Jeipreethi kanggeyavelu.K	X	X	X	X	X	X	X	X	X	X	X	X	X	X	X	X
52.	2302M ED202 02	Noor nisha.A	X	X	X	X	X	X	X	X	X	X	X	X	X	X	X	X
53.	2302M ED202 03	Nivethitha.R	X	X	X	X	X	X	X	X	X	X	X	X	X	X	X	X
54.	2302M ED202 04	Mahalakshmi.R	X	X	X	X	X	X	X	X	X	X	X	X	X	X	X	X
55.	2302M ED202 05	Preethi.N	X	X	X	X	X	X	X	X	X	X	X	X	X	X	X	X
56.	2302M ED202 06	AbiramiR	X	X	X	X	X	X	X	X	X	X	X	X	X	X	X	X
57.	2302M ED202 07	P. Ganesan	X	X	X	X	X	X	X	X	X	X	X	X	X	X	X	X
58.	2302M ED202 08	V. JayaKumar	X	X	X	X	X	X	X	X	X	X	X	X	X	X	X	X
59.	2302M ED202 09	L. Mekala	X	X	X	X	X	X	X	X	X	X	X	X	X	X	X	X
60.	2302M ED202 10	S. Annapoorni	X	X	X	X	X	X	X	X	X	X	X	X	X	X	X	X
61.	2302M ED202 11	R. Bommi	X	X	X	X	X	X	X	X	X	X	X	X	X	X	X	X
62.	2302M ED202 12	J. Elavarasi	X	X	X	X	X	X	X	X	X	X	X	X	X	X	X	X
63.	2302M ED202 13	P. Ezhilarasi	X	X	X	X	X	X	X	X	X	X	X	X	X	X	X	X
64.	2302M ED202 14	K. Joice Mary	X	X	X	X	X	X	X	X	X	X	X	X	X	X	X	X

HOD

School of Education
Ponnaiyah Ramajayam Institute of
Science & Technology (PRIST)
THANJAVUR - 613 403

DEAN

School of Education
Ponnaiyah Ramajayam Institute of
Science & Technology (PRIST)
THANJAVUR

65.	2302M ED202 15	P. Krishnapriya	X	X	X	X	X	X	X	X	X	X	X	X	X	X	X	X
66.	2302M ED202 16	T.Kumari	X	X	X	X	X	X	X	X	X	X	X	X	X	X	X	X
67.	2302M ED202 17	S.Manimekalai	X	X	X	X	X	X	X	X	X	X	X	X	X	X	X	X
68.	2302M ED202 18	M.Jeyarani	X	X	X	X	X	X	X	X	X	X	X	X	X	X	X	X
69.	2302M ED202 19	P.Selvarani	X	X	X	X	X	X	X	X	X	X	X	X	X	X	X	X
70.	2302M ED202 20	M.Suseela	X	X	X	X	X	X	X	X	X	X	X	X	X	X	X	X
71.	2302M ED202 21	A.Sirajinnisha	X	X	X	X	X	X	X	X	X	X	X	X	X	X	X	X
72.	2302M ED202 22	T.Sollararasan	X	X	X	X	X	X	X	X	X	X	X	X	X	X	X	X
73.	2302M ED202 23	S.Kavitha	X	X	X	X	X	X	X	X	X	X	X	X	X	X	X	X
74.	2302M ED202 24	T.Sumathi	X	X	X	X	X	X	X	X	X	X	X	X	X	X	X	X
75.	2302M ED202 25	A.T.Banu	X	X	X	X	X	X	X	X	X	X	X	X	X	X	X	X
Staff signature			<i>[Signature]</i>	<i>[Signature]</i>	<i>[Signature]</i>	<i>[Signature]</i>	<i>[Signature]</i>	<i>[Signature]</i>	<i>[Signature]</i>	<i>[Signature]</i>	<i>[Signature]</i>	<i>[Signature]</i>	<i>[Signature]</i>	<i>[Signature]</i>	<i>[Signature]</i>	<i>[Signature]</i>	<i>[Signature]</i>	<i>[Signature]</i>

[Signature]
HOD
 School of Education
 Ponnaiyah Ramajayam Institute of
 Science & Technology (PRIST)
 THANJAVUR - 613 403.

[Signature]
DEAN
 School of Education
 Ponnaiyah Ramajayam Institute of
 Science & Technology (PRIST)
 THANJAVUR - 613 403.



**PONNAIYAH RAMAJAYAM INSTITUTE OF
SCIENCE & TECHNOLOGY (PRIST)**

Declared as DEEMED-TO-BE UNIVERSITY
U/s 3 of UGC Act, 1956

SCHOOL OF EDUCATION
Value Added Course
COURSE TITLE: GENERAL AWARENESS COURSE
Students Attendance Date: (October - 2023)
Academic Year 2023 - 2024

S.No	Reg.No	Name	02	03	04	06	09	10	13	14	16	18	19	20	23	24	27
1.	2302E DTA10 201	MATHAVI.R	X	X	X	X	X	X	X	X	X	X	X	X	X	X	X
2.	2302E DEN10 101	SUKENDRAN.R	X	X	X	X	X	X	X	X	X	X	X	X	X	X	X
3.	230ED MA102 01	KOWSALYA.M	X	X	X	X	X	X	X	X	X	X	X	X	X	X	X
4.	2301E DMA1 0202	KARTHIKA.K	X	X	X	X	X	X	X	X	X	X	X	X	X	X	X
5.	2302E DMA1 0203	UMA.K	X	X	X	X	X	X	X	X	X	X	X	X	X	X	X
6.	2302E DMA1 0204	YAMUNA.M	X	X	X	X	X	X	X	X	X	X	X	X	X	X	X
7.	2302E DPC10 201	SIMRAN.E	X	X	X	X	X	X	X	X	X	X	X	X	X	X	X
8.	2302E DPC10 202	BABY SHALINI.L	X	X	X	X	X	X	X	X	X	X	X	X	X	X	X
9.	2302E DPC10 203	HEMA.G	X	X	X	X	X	X	X	X	X	X	X	X	X	X	X
10.	2302E DPC10 204	GOWSALYA.G	X	X	X	X	X	X	X	X	X	X	X	X	X	X	X
11.	2302E DPC10 205	ANUSUYA.D	X	X	X	X	X	X	X	X	X	X	X	X	X	X	X
12.	2302E DPC10 101	AMALRAJ. B	X	X	X	X	X	X	X	X	X	X	X	X	X	X	X
13.	2302E DBS10 201	PARIMALA.S	X	X	X	X	X	X	X	X	X	X	X	X	X	X	X
14.	2302E DBS10 202	PRIYADHARSH INLP	X	X	X	X	X	X	X	X	X	X	X	X	X	X	X

HOD

School of Education

Ponnaiyah Ramajayam Institute of
Science & Technology (PRIST)
THANJAVUR - 613 403.

DEAN

School of Education

Ponnaiyah Ramajayam Institute of
Science & Technology (PRIST)
THANJAVUR - 613 403.

15.	2301E DCS10 201	PRADEEPA.R	X	X	X	X	X	X	X	X	X	X	X	X	X	X	X
16.	2301E DCS10 101	KARTHIK. M	X	X	X	X	X	X	X	X	X	X	X	X	X	X	X
17.	2302E DCO10 201	VEENA.P	X	X	X	X	X	X	X	X	X	X	X	X	X	X	X
18.	2302E DHI10 201	JAYANTHLD	X	X	X	X	X	X	X	X	X	X	X	X	X	X	X
19.	2302E DGO10 201	ABIRAMASUN DHARIS	X	X	X	X	X	X	X	X	X	X	X	X	X	X	X
20.	2302E DTA10 202	C.Amaravathi	X	X	X	X	X	X	X	X	X	X	X	X	X	X	X
21.	2302E DTA10 203	S.Anandhi	X	X	X	X	X	X	X	X	X	X	X	X	X	X	X
22.	2302E DTA10 204	N.Buvaneswari	X	X	X	X	X	X	X	X	X	X	X	X	X	X	X
23.	2302E DTA10 205	S.Juliet	X	X	X	X	X	X	X	X	X	X	X	X	X	X	X
24.	2302E DTA10 206	S.Jenifar	X	X	X	X	X	X	X	X	X	X	X	X	X	X	X
25.	2302E DTA10 207	X.Arockiya Mary	X	X	X	X	X	X	X	X	X	X	X	X	X	X	X
26.	2302E DTA10 208	R.Darathy	X	X	X	X	X	X	X	X	X	X	X	X	X	X	X
27.	2302E DTA10 209	B.Methulakshmi	X	X	X	X	X	X	X	X	X	X	X	X	X	X	X
28.	2302E DEN10 102	S.Sumitra	X	X	X	X	X	X	X	X	X	X	X	X	X	X	X
29.	2302E DEN10 103	D.Vasumathi	X	X	X	X	X	X	X	X	X	X	X	X	X	X	X
30.	2302E DEN10 104	S.Divya	X	X	X	X	X	X	X	X	X	X	X	X	X	X	X
31.	2302E DEN10 105	V.Chitra	X	X	X	X	X	X	X	X	X	X	X	X	X	X	X

HOD

School of Education
Ponnaiyah Ramajayam Institute of
Science & Technology (PRIST)
THANJAVUR - 613 403

DEAN

School of Education
Ponnaiyah Ramajayam Institute of
Science & Technology (PRIST)
THANJAVUR - 613 403

32.	2302E DEN10 106	G.Nandhini	X	X	X	X	X	X	X	X	X	X	X	X	X	X	X
33.	2302E DEN10 107	J.Revathi	X	X	X	X	X	X	X	X	X	X	X	X	X	X	X
34.	2302E DEN10 108	J.Sangeetha	X	X	X	X	X	X	X	X	X	X	X	X	X	X	X
35.	2302E DEN10 109	T.Sasireka	X	X	X	X	X	X	X	X	X	X	X	X	X	X	X
36.	2302E DEN10 110	G.Lakshmi	X	X	X	X	X	X	X	X	X	X	X	X	X	X	X
37.	2302E DEN10 111	T.Sutha	X	X	X	X	X	X	X	X	X	X	X	X	X	X	X
38.	2302E DEN10 112	T.Indira	X	X	X	X	X	X	X	X	X	X	X	X	X	X	X
39.	230ED MA102 02	M.Krishnaveni	X	X	X	X	X	X	X	X	X	X	X	X	X	X	X
40.	230ED MA102 03	G.Regavathi	X	X	X	X	X	X	X	X	X	X	X	X	X	X	X
41.	230ED MA102 04	H. Jahabar Nachiya	X	X	X	X	X	X	X	X	X	X	X	X	X	X	X
42.	230ED MA102 05	V. Kiruba	X	X	X	X	X	X	X	X	X	X	X	X	X	X	X
43.	230ED MA102 06	K.Ambika	X	X	X	X	X	X	X	X	X	X	X	X	X	X	X
44.	230ED MA102 07	L.Angelomary	X	X	X	X	X	X	X	X	X	X	X	X	X	X	X
45.	230ED MA102 02	G.Saranya	X	X	X	X	X	X	X	X	X	X	X	X	X	X	X
46.	230ED MA102 03	R.Amuthakumari	X	X	X	X	X	X	X	X	X	X	X	X	X	X	X
47.	2302E DBS10 204	R.Kalaivani	X	X	X	X	X	X	X	X	X	X	X	X	X	X	X
48.	2302E DBS10 205	P.Kanmani	X	X	X	X	X	X	X	X	X	X	X	X	X	X	X

cl

HOD

School of Education
Ponnaiyah Ramajayam Institute of
Science & Technology (PRIST)
THANJAVUR - 613 403.

ph
DEAN

School of Education
Ponnaiyah Ramajayam Institute of
Science & Technology (PRIST)
THANJAVUR - 613 403.















49.	2302E DBS10 206	T.Meena	X	X	X	X	X	X	X	X	X	X	X	X	X	X	X	X
50.	2302E DBS10 207	K.Sathiyapriya	X	X	X	X	X	X	X	X	X	X	X	X	X	X	X	X
51.	2302M ED202 01	Jeipreethi kanggeyavelu.K	X	X	X	X	X	X	X	X	X	X	X	X	X	X	X	X
52.	2302M ED202 02	Noor nisha.A	X	X	X	X	X	X	X	X	X	X	X	X	X	X	X	X
53.	2302M ED202 03	Nivethitha.R	X	X	X	X	X	X	X	X	X	X	X	X	X	X	X	X
54.	2302M ED202 04	Mahalakshmi.R	X	X	X	X	X	X	X	X	X	X	X	X	X	X	X	X
55.	2302M ED202 05	Preethi.N	X	X	X	X	X	X	X	X	X	X	X	X	X	X	X	X
56.	2302M ED202 06	AbiramiR	X	X	X	X	X	X	X	X	X	X	X	X	X	X	X	X
57.	2302M ED202 07	P. Ganesan	X	X	X	X	X	X	X	X	X	X	X	X	X	X	X	X
58.	2302M ED202 08	V. JayaKumar	X	X	X	X	X	X	X	X	X	X	X	X	X	X	X	X
59.	2302M ED202 09	L. Mekala	X	X	X	X	X	X	X	X	X	X	X	X	X	X	X	X
60.	2302M ED202 10	S. Annapoorni	X	X	X	X	X	X	X	X	X	X	X	X	X	X	X	X
61.	2302M ED202 11	R. Bommi	X	X	X	X	X	X	X	X	X	X	X	X	X	X	X	X
62.	2302M ED202 12	J. Elavarasi	X	X	X	X	X	X	X	X	X	X	X	X	X	X	X	X
63.	2302M ED202 13	P. Ezhilarasi	X	X	X	X	X	X	X	X	X	X	X	X	X	X	X	X
64.	2302M ED202 14	K. Joice Mary	X	X	X	X	X	X	X	X	X	X	X	X	X	X	X	X

HOD

School of Education
Ponnaiyah Ramajayam Institute of
Science & Technology (PRIIST)
THANJAVUR - 613 403.

DEAN

School of Education
Ponnaiyah Ramajayam Institute of
Science & Technology (PRIIST)
THANJAVUR - Page 889 of 1367

65.	2302M ED202 15	P. Krishnapriya	X	X	X	X	X	X	X	X	X	X	X	X	X	X	X
66.	2302M ED202 16	T.Kumari	X	X	X	X	X	X	X	X	X	X	X	X	X	X	X
67.	2302M ED202 17	S.Manimekalai	X	X	X	X	X	X	X	X	X	X	X	X	X	X	X
68.	2302M ED202 18	M.Jeyarani	X	X	X	X	X	X	X	X	X	X	X	X	X	X	X
69.	2302M ED202 19	P.Selvarani	X	X	X	X	X	X	X	X	X	X	X	X	X	X	X
70.	2302M ED202 20	M.Suseela	X	X	X	X	X	X	X	X	X	X	X	X	X	X	X
71.	2302M ED202 21	A.Sirajinnisha	X	X	X	X	X	X	X	X	X	X	X	X	X	X	X
72.	2302M ED202 22	T.Sollararasan	X	X	X	X	X	X	X	X	X	X	X	X	X	X	X
73.	2302M ED202 23	S.Kavitha	X	X	X	X	X	X	X	X	X	X	X	X	X	X	X
74.	2302M ED202 24	T.Sumathi	X	X	X	X	X	X	X	X	X	X	X	X	X	X	X
75.	2302M ED202 25	A.T.Banu	X	X	X	X	X	X	X	X	X	X	X	X	X	X	X
Staff signature																	

HOD
 School of Education
 Ponnaiyah Ramajayam Institute of
 Science & Technology (PRIST)
 THANJAVUR - 613 403.

DEAN
 School of Education
 Ponnaiyah Ramajayam Institute of
 Science & Technology (PRIST)
 THANJAVUR - 613 403.



**PONNAIYAH RAMAJAYAM INSTITUTE OF
SCIENCE & TECHNOLOGY (PRIST)**

Declared as DEEMED-TO-BE-UNIVERSITY
U/s 3 of UGC Act, 1956

SCHOOL OF EDUCATION
Value Added Course
COURSE TITLE: GENERAL AWARENESS COURSE
Students Attendance Date: (November - 2023)
Academic Year 2023 – 2024

S.No	Reg.No	Name	02	03	04	06	09	10	13	14	16	18	19	20	23	24	27
1.	2302E DTA10 201	MATHAVLR	X	X	X	X	X	X	X	X	X	X	X	X	X	X	X
2.	2302E DEN10 101	SUKENDRAN.R	X	X	X	X	X	X	X	X	X	X	X	X	X	X	X
3.	230ED MA102 01	KOWSALYA.M	X	X	X	X	X	X	X	X	X	X	X	X	X	X	X
4.	2301E DMA1 0202	KARTHIKA.K	X	X	X	X	X	X	X	X	X	X	X	X	X	X	X
5.	2302E DMA1 0203	UMA.K	X	X	X	X	X	X	X	X	X	X	X	X	X	X	X
6.	2302E DMA1 0204	YAMUNA.M	X	X	X	X	X	X	X	X	X	X	X	X	X	X	X
7.	2302E DPC10 201	SIMRAN.E	X	X	X	X	X	X	X	X	X	X	X	X	X	X	X
8.	2302E DPC10 202	BABY SHALINLL	X	X	X	X	X	X	X	X	X	X	X	X	X	X	X
9.	2302E DPC10 203	HEMA.G	X	X	X	X	X	X	X	X	X	X	X	X	X	X	X
10.	2302E DPC10 204	GOWSALYA.G	X	X	X	X	X	X	X	X	X	X	X	X	X	X	X
11.	2302E DPC10 205	ANUSUYA.D	X	X	X	X	X	X	X	X	X	X	X	X	X	X	X
12.	2302E DPC10 101	AMALRAJ. B	X	X	X	X	X	X	X	X	X	X	X	X	X	X	X
13.	2302E DBS10 201	PARIMALA.S	X	X	X	X	X	X	X	X	X	X	X	X	X	X	X
14.	2302E DBS10 202	PRIYADHARSH INLP	X	X	X	X	X	X	X	X	X	X	X	X	X	X	X

HOD

DEAN

15.	2301E DCS10 201	PRADEEPA.R	X	X	X	X	X	X	X	X	X	X	X	X	X	X	X
16.	2301E DCS10 101	KARTHIK. M	X	X	X	X	X	X	X	X	X	X	X	X	X	X	X
17.	2302E DCO10 201	VEENA.P	X	X	X	X	X	X	X	X	X	X	X	X	X	X	X
18.	2302E DHI10 201	JAYANTHI.D	X	X	X	X	X	X	X	X	X	X	X	X	X	X	X
19.	2302E DGO10 201	ABIRAMASUN DHARIS	X	X	X	X	X	X	X	X	X	X	X	X	X	X	X
20.	2302E DTA10 202	C.Amaravathi	X	X	X	X	X	X	X	X	X	X	X	X	X	X	X
21.	2302E DTA10 203	S.Anandhi	X	X	X	X	X	X	X	X	X	X	X	X	X	X	X
22.	2302E DTA10 204	N.Buveneswari	X	X	X	X	X	X	X	X	X	X	X	X	X	X	X
23.	2302E DTA10 205	S.Juliet	X	X	X	X	X	X	X	X	X	X	X	X	X	X	X
24.	2302E DTA10 206	S.Jenifar	X	X	X	X	X	X	X	X	X	X	X	X	X	X	X
25.	2302E DTA10 207	X.Arockiya Mary	X	X	X	X	X	X	X	X	X	X	X	X	X	X	X
26.	2302E DTA10 208	R.Darathy	X	X	X	X	X	X	X	X	X	X	X	X	X	X	X
27.	2302E DTA10 209	B.Muthulakshmi	X	X	X	X	X	X	X	X	X	X	X	X	X	X	X
28.	2302E DEN10 102	S.Sumitra	X	X	X	X	X	X	X	X	X	X	X	X	X	X	X
29.	2302E DEN10 103	D.Vasumathi	X	X	X	X	X	X	X	X	X	X	X	X	X	X	X
30.	2302E DEN10 104	S.Divya	X	X	X	X	X	X	X	X	X	X	X	X	X	X	X
31.	2302E DEN10 105	V.Chitra	X	X	X	X	X	X	X	X	X	X	X	X	X	X	X

2

DEAN

32.	2302E DEN10 106	G.Nandhini	X	X	X	X	X	X	X	X	X	X	X	X	X	X	X	X
33.	2302E DEN10 107	J.Revathi	X	X	X	X	X	X	X	X	X	X	X	X	X	X	X	X
34.	2302E DEN10 108	J.Sangeetha	X	X	X	X	X	X	X	X	X	X	X	X	X	X	X	X
35.	2302E DEN10 109	T.Sasireka	X	X	X	X	X	X	X	X	X	X	X	X	X	X	X	X
36.	2302E DEN10 110	G.Lakshmi	X	X	X	X	X	X	X	X	X	X	X	X	X	X	X	X
37.	2302E DEN10 111	T.Sutha	X	X	X	X	X	X	X	X	X	X	X	X	X	X	X	X
38.	2302E DEN10 112	T.Indira	X	X	X	X	X	X	X	X	X	X	X	X	X	X	X	X
39.	230ED MA102 02	M.Krishnaveni	X	X	X	X	X	X	X	X	X	X	X	X	X	X	X	X
40.	230ED MA102 03	G.Regavathi	X	X	X	X	X	X	X	X	X	X	X	X	X	X	X	X
41.	230ED MA102 04	H. Jahabar Nachiya	X	X	X	X	X	X	X	X	X	X	X	X	X	X	X	X
42.	230ED MA102 05	V. Kiruba	X	X	X	X	X	X	X	X	X	X	X	X	X	X	X	X
43.	230ED MA102 06	K.Ambika	X	X	X	X	X	X	X	X	X	X	X	X	X	X	X	X
44.	230ED MA102 07	L.Angeliomary	X	X	X	X	X	X	X	X	X	X	X	X	X	X	X	X
45.	230ED MA102 02	G.Saranya	X	X	X	X	X	X	X	X	X	X	X	X	X	X	X	X
46.	230ED MA102 03	R.Amuthakumari	X	X	X	X	X	X	X	X	X	X	X	X	X	X	X	X
47.	2302E DBS10 204	R.Kalaivani	X	X	X	X	X	X	X	X	X	X	X	X	X	X	X	X
48.	2302E DBS10 205	P.Kanmani	X	X	X	X	X	X	X	X	X	X	X	X	X	X	X	X



HOD

School of Education
Ponnaiyah Ramajayam Institute of
Science & Technology (PRIST)
THANJAVUR - 613 403.

DEAN

School of Education
Ponnaiyah Ramajayam Institute of
Science & Technology (PRIST)
THANJAVUR - 613 403.

49.	2302E DBS10 206	T.Meena	X	X	X	X	X	X	X	X	X	X	X	X	X	X	X	X
50.	2302E DBS10 207	K.Sathiyapriya	X	X	X	X	X	X	X	X	X	X	X	X	X	X	X	X
51.	2302M ED202 01	Jeipreethi kanggeyavelu.K	X	X	X	X	X	X	X	X	X	X	X	X	X	X	X	X
52.	2302M ED202 02	Noor nisha.A	X	X	X	X	X	X	X	X	X	X	X	X	X	X	X	X
53.	2302M ED202 03	Nivethitha.R	X	X	X	X	X	X	X	X	X	X	X	X	X	X	X	X
54.	2302M ED202 04	Mahalakshmi.R	X	X	X	X	X	X	X	X	X	X	X	X	X	X	X	X
55.	2302M ED202 05	Preethi.N	X	X	X	X	X	X	X	X	X	X	X	X	X	X	X	X
56.	2302M ED202 06	AbiramiR	X	X	X	X	X	X	X	X	X	X	X	X	X	X	X	X
57.	2302M ED202 07	P. Ganesan	X	X	X	X	X	X	X	X	X	X	X	X	X	X	X	X
58.	2302M ED202 08	V. JayaKumar	X	X	X	X	X	X	X	X	X	X	X	X	X	X	X	X
59.	2302M ED202 09	L. Mekala	X	X	X	X	X	X	X	X	X	X	X	X	X	X	X	X
60.	2302M ED202 10	S. Annapoorni	X	X	X	X	X	X	X	X	X	X	X	X	X	X	X	X
61.	2302M ED202 11	R. Bommi	X	X	X	X	X	X	X	X	X	X	X	X	X	X	X	X
62.	2302M ED202 12	J. Elavarasi	X	X	X	X	X	X	X	X	X	X	X	X	X	X	X	X
63.	2302M ED202 13	P. Ezhilarasi	X	X	X	X	X	X	X	X	X	X	X	X	X	X	X	X
64.	2302M ED202 14	K. Joice Mary	X	X	X	X	X	X	X	X	X	X	X	X	X	X	X	X

HOD

DEAN

65.	2302M ED202 15	P. Krishnapriya	X	X	X	X	X	X	X	X	X	X	X	X	X	X	X
66.	2302M ED202 16	T.Kumari	X	X	X	X	X	X	X	X	X	X	X	X	X	X	X
67.	2302M ED202 17	S.Manimekalai	X	X	X	X	X	X	X	X	X	X	X	X	X	X	X
68.	2302M ED202 18	M.Jeyarani	X	X	X	X	X	X	X	X	X	X	X	X	X	X	X
69.	2302M ED202 19	P.Selvarani	X	X	X	X	X	X	X	X	X	X	X	X	X	X	X
70.	2302M ED202 20	M.Suseela	X	X	X	X	X	X	X	X	X	X	X	X	X	X	X
71.	2302M ED202 21	A.Sirajinnisha	X	X	X	X	X	X	X	X	X	X	X	X	X	X	X
72.	2302M ED202 22	T.Sollararasan	X	X	X	X	X	X	X	X	X	X	X	X	X	X	X
73.	2302M ED202 23	S.Kavitha	X	X	X	X	X	X	X	X	X	X	X	X	X	X	X
74.	2302M ED202 24	T.Sumathi	X	X	X	X	X	X	X	X	X	X	X	X	X	X	X
75.	2302M ED202 25	A.T.Banu	X	X	X	X	X	X	X	X	X	X	X	X	X	X	X
Staff signature			<i>Rel</i>	<i>Rel</i>	<i>Rel</i>	<i>Rel</i>	<i>Rel</i>	<i>Rel</i>	<i>Rel</i>	<i>Rel</i>	<i>Rel</i>	<i>Rel</i>	<i>Rel</i>	<i>Rel</i>	<i>Rel</i>	<i>Rel</i>	<i>Rel</i>

 HOD
 School of Education
 Ponnaiyah Ramajayam Institute of
 Science & Technology (PRTST)
 THANJAVUR - 613 403

 DEAN
 School of Education
 Ponnaiyah Ramajayam Institute
 Science & Technology (PRTST)
 THANJAVUR - 613 403



**PONNAIYAH RAMAJAYAM INSTITUTE OF
SCIENCE & TECHNOLOGY (PRIST)**

Declared as DEEMED-TO-BE-UNIVERSITY
U/s 3 of UGC Act, 1956

SCHOOL OF EDUCATION
Value Added Course
COURSE TITLE: MENTAL HEALTH
Students Attendance Date: (September - 2023)
Academic Year 2023 - 2024

S.No	Reg.No	Name	07	08	09	10	11	12	13	14	16	18	19	20	23	24	27
1.	2302E DTA10 201	MATHAVI.R	X	X	X	X	X	X	X	X	X	X	X	X	X	X	X
2.	2302E DEN10 101	SUKENDRAN.R	X	X	X	X	X	X	X	X	X	X	X	X	X	X	X
3.	230ED MA102 01	KOWSALYA.M	X	X	X	X	X	X	X	X	X	X	X	X	X	X	X
4.	2301E DMA1 0202	KARTHIKA.K	X	X	X	X	X	X	X	X	X	X	X	X	X	X	X
5.	2302E DMA1 0203	UMA.K	X	X	X	X	X	X	X	X	X	X	X	X	X	X	X
6.	2302E DMA1 0204	YAMUNA.M	X	X	X	X	X	X	X	X	X	X	X	X	X	X	X
7.	2302E DPC10 201	SIMRAN.E	X	X	X	X	X	X	X	X	X	X	X	X	X	X	X
8.	2302E DPC10 202	BABY SHALINLL	X	X	X	X	X	X	X	X	X	X	X	X	X	X	X
9.	2302E DPC10 203	HEMA.G	X	X	X	X	X	X	X	X	X	X	X	X	X	X	X
10.	2302E DPC10 204	GOWSALYA.G	X	X	X	X	X	X	X	X	X	X	X	X	X	X	X
11.	2302E DPC10 205	ANUSUYA.D	X	X	X	X	X	X	X	X	X	X	X	X	X	X	X
12.	2302E DPC10 101	AMALRAJ. B	X	X	X	X	X	X	X	X	X	X	X	X	X	X	X
13.	2302E DBS10 201	PARIMALA.S	X	X	X	X	X	X	X	X	X	X	X	X	X	X	X
14.	2302E DBS10 202	PRIYADHARSH INLP	X	X	X	X	X	X	X	X	X	X	X	X	X	X	X

HOD

School of Education
Ponnaiyah Ramajayam Institute of
Science & Technology (PRIST)
THANJAVUR - 613 403.

DEAN

School of Education
Ponnaiyah Ramajayam Institute of
Science & Technology (PRIST)
- THANJAVUR - 613 403.

15.	2301E DCS10 201	PRADEEPA.R	X	X	X	X	X	X	X	X	X	X	X	X	X	X	X	X
16.	2301E DCS10 101	KARTHIK. M	X	X	X	X	X	X	X	X	X	X	X	X	X	X	X	X
17.	2302E DCO10 201	VEENA.P	X	X	X	X	X	X	X	X	X	X	X	X	X	X	X	X
18.	2302E DHI10 201	JAYANTHI.D	X	X	X	X	X	X	X	X	X	X	X	X	X	X	X	X
19.	2302E DGO10 201	ABIRAMASUN DHARLS	X	X	X	X	X	X	X	X	X	X	X	X	X	X	X	X
20.	2302E DTA10 202	C.Amaravathi	X	X	X	X	X	X	X	X	X	X	X	X	X	X	X	X
21.	2302E DTA10 203	S.Anandhi	X	X	X	X	X	X	X	X	X	X	X	X	X	X	X	X
22.	2302E DTA10 204	N.Burvaneswari	X	X	X	X	X	X	X	X	X	X	X	X	X	X	X	X
23.	2302E DTA10 205	S.Juliet	X	X	X	X	X	X	X	X	X	X	X	X	X	X	X	X
24.	2302E DTA10 206	S.Jenifar	X	X	X	X	X	X	X	X	X	X	X	X	X	X	X	X
25.	2302E DTA10 207	X.Arockiya Mary	X	X	X	X	X	X	X	X	X	X	X	X	X	X	X	X
26.	2302E DTA10 208	R.Darathy	X	X	X	X	X	X	X	X	X	X	X	X	X	X	X	X
27.	2302E DTA10 209	B.Muthulakshmi	X	X	X	X	X	X	X	X	X	X	X	X	X	X	X	X
28.	2302E DEN10 102	S.Sumitra	X	X	X	X	X	X	X	X	X	X	X	X	X	X	X	X
29.	2302E DEN10 103	D.Vasumathi	X	X	X	X	X	X	X	X	X	X	X	X	X	X	X	X
30.	2302E DEN10 104	S.Divya	X	X	X	X	X	X	X	X	X	X	X	X	X	X	X	X
31.	2302E DEN10 105	V.Chitra	X	X	X	X	X	X	X	X	X	X	X	X	X	X	X	X



HOD

School of Education
Ponnaiyan Ramajayam Institute of
Science & Technology (PRIIST)
THANJAVUR - 613 403.



DEAN

School of Education
Ponnaiyan Ramajayam Institute of
Science & Technology (PRIIST)
THANJAVUR - 613 403.

32.	2302E DEN10 106	G.Nandhini	X	X	X	X	X	X	X	X	X	X	X	X	X	X	X	X
33.	2302E DEN10 107	J.Revathi	X	X	X	X	X	X	X	X	X	X	X	X	X	X	X	X
34.	2302E DEN10 108	J.Sangeetha	X	X	X	X	X	X	X	X	X	X	X	X	X	X	X	X
35.	2302E DEN10 109	T.Sasireka	X	X	X	X	X	X	X	X	X	X	X	X	X	X	X	X
36.	2302E DEN10 110	G.Lakshmi	X	X	X	X	X	X	X	X	X	X	X	X	X	X	X	X
37.	2302E DEN10 111	T.Sutha	X	X	X	X	X	X	X	X	X	X	X	X	X	X	X	X
38.	2302E DEN10 112	T.Indira	X	X	X	X	X	X	X	X	X	X	X	X	X	X	X	X
39.	230ED MA102 02	M.Krishnaveni	X	X	X	X	X	X	X	X	X	X	X	X	X	X	X	X
40.	230ED MA102 03	G.Regavathi	X	X	X	X	X	X	X	X	X	X	X	X	X	X	X	X
41.	230ED MA102 04	H. Jahabar Nachiya	X	X	X	X	X	X	X	X	X	X	X	X	X	X	X	X
42.	230ED MA102 05	V. Kiruba	X	X	X	X	X	X	X	X	X	X	X	X	X	X	X	X
43.	230ED MA102 06	K.Ambika	X	X	X	X	X	X	X	X	X	X	X	X	X	X	X	X
44.	230ED MA102 07	L.Angelomary	X	X	X	X	X	X	X	X	X	X	X	X	X	X	X	X
45.	230ED MA102 02	G.Saranya	X	X	X	X	X	X	X	X	X	X	X	X	X	X	X	X
46.	230ED MA102 03	R.Amuthakumari	X	X	X	X	X	X	X	X	X	X	X	X	X	X	X	X
47.	2302E DBS10 204	R.Kalaivani	X	X	X	X	X	X	X	X	X	X	X	X	X	X	X	X
48.	2302E DBS10 205	P.Kanmani	X	X	X	X	X	X	X	X	X	X	X	X	X	X	X	X

HOD

School of Education
Ponnaiyah Ramajayam Institute of
Science & Technology (PRIST)
THANJAVUR - 613 403.

U=AN

School of Education
Ponnaiyah Ramajayam Institute of
Science & Technology (PRIST)
THANJAVUR - 613 403.

49.	2302E DBS10 206	T.Meena	X	X	X	X	X	X	X	X	X	X	X	X	X	X	X	X
50.	2302E DBS10 207	K.Sathiyapriya	X	X	X	X	X	X	X	X	X	X	X	X	X	X	X	X
51.	2302M ED202 01	Jeipreethi kanggeyavelu.K	X	X	X	X	X	X	X	X	X	X	X	X	X	X	X	X
52.	2302M ED202 02	Noor nisha.A	X	X	X	X	X	X	X	X	X	X	X	X	X	X	X	X
53.	2302M ED202 03	Nivethitha.R	X	X	X	X	X	X	X	X	X	X	X	X	X	X	X	X
54.	2302M ED202 04	Mahalakshmi.R	X	X	X	X	X	X	X	X	X	X	X	X	X	X	X	X
55.	2302M ED202 05	Preethi.N	X	X	X	X	X	X	X	X	X	X	X	X	X	X	X	X
56.	2302M ED202 06	AbiramiR	X	X	X	X	X	X	X	X	X	X	X	X	X	X	X	X
57.	2302M ED202 07	P. Ganesan	X	X	X	X	X	X	X	X	X	X	X	X	X	X	X	X
58.	2302M ED202 08	V. JayaKumar	X	X	X	X	X	X	X	X	X	X	X	X	X	X	X	X
59.	2302M ED202 09	L. Mekala	X	X	X	X	X	X	X	X	X	X	X	X	X	X	X	X
60.	2302M ED202 10	S. Annapoorni	X	X	X	X	X	X	X	X	X	X	X	X	X	X	X	X
61.	2302M ED202 11	R. Bommi	X	X	X	X	X	X	X	X	X	X	X	X	X	X	X	X
62.	2302M ED202 12	J. Elavarasi	X	X	X	X	X	X	X	X	X	X	X	X	X	X	X	X
63.	2302M ED202 13	P. Ezhilarasi	X	X	X	X	X	X	X	X	X	X	X	X	X	X	X	X
64.	2302M ED202 14	K. Joice Mary	X	X	X	X	X	X	X	X	X	X	X	X	X	X	X	X

HOD

School of Education
Ponnaiyah Ramajayam Institute of
Science & Technology (PRIST)
THANJAVUR - 613 403.

DEAN

School of Education
Ponnaiyah Ramajayam Institute of
Science & Technology
THANJAVUR

65.	2302M ED202 15	P. Krishnapriya	X	X	X	X	X	X	X	X	X	X	X	X	X	X	X	X
66.	2302M ED202 16	T.Kumari	X	X	X	X	X	X	X	X	X	X	X	X	X	X	X	X
67.	2302M ED202 17	S.Manimekalai	X	X	X	X	X	X	X	X	X	X	X	X	X	X	X	X
68.	2302M ED202 18	M.Jeyarani	X	X	X	X	X	X	X	X	X	X	X	X	X	X	X	X
69.	2302M ED202 19	P.Selvarani	X	X	X	X	X	X	X	X	X	X	X	X	X	X	X	X
70.	2302M ED202 20	M.Suseela	X	X	X	X	X	X	X	X	X	X	X	X	X	X	X	X
71.	2302M ED202 21	A.Sirajinnisha	X	X	X	X	X	X	X	X	X	X	X	X	X	X	X	X
72.	2302M ED202 22	T.Sollararasan	X	X	X	X	X	X	X	X	X	X	X	X	X	X	X	X
73.	2302M ED202 23	S.Kavitha	X	X	X	X	X	X	X	X	X	X	X	X	X	X	X	X
74.	2302M ED202 24	T.Sumathi	X	X	X	X	X	X	X	X	X	X	X	X	X	X	X	X
75.	2302M ED202 25	A.T.Banu	X	X	X	X	X	X	X	X	X	X	X	X	X	X	X	X
Staff signature			<i>[Signature]</i>	<i>[Signature]</i>	<i>[Signature]</i>	<i>[Signature]</i>	<i>[Signature]</i>	<i>[Signature]</i>	<i>[Signature]</i>	<i>[Signature]</i>	<i>[Signature]</i>	<i>[Signature]</i>	<i>[Signature]</i>	<i>[Signature]</i>	<i>[Signature]</i>	<i>[Signature]</i>	<i>[Signature]</i>	<i>[Signature]</i>

[Signature]
HOD
 School of Education
 Ponnaiyah Ramajayam Institute of
 Science & Technology (PRIST)
 THANJAVUR - 613 403.

[Signature]
DEAN
 School of Education
 Ponnaiyah Ramajayam Institute of
 Science & Technology (PRIST)
 THANJAVUR - 613 403.



PONNAIYAH RAMAJAYAM INSTITUTE OF
SCIENCE & TECHNOLOGY (PRIST)

Declared as DEFEMED-TO-BE-UNIVERSITY
U/s 3 of UGC Act, 1956

SCHOOL OF EDUCATION
Value Added Course
COURSE TITLE: MENTAL HEALTH
Students Attendance Date: (October - 2023)
Academic Year 2023 - 2024

S.No	Reg.No	Name	02	03	04	06	09	10	13	14	16	18	19	20	23	24	27
1.	2302E DTA10 201	MATHAVI.R	X	X	X	X	X	X	X	X	X	X	X	X	X	X	X
2.	2302E DEN10 101	SUKENDRAN.R	X	X	X	X	X	X	X	X	X	X	X	X	X	X	X
3.	230ED MA102 01	KOWSALYA.M	X	X	X	X	X	X	X	X	X	X	X	X	X	X	X
4.	2301E DMA1 0202	KARTHIKA.K	X	X	X	X	X	X	X	X	X	X	X	X	X	X	X
5.	2302E DMA1 0203	UMA.K	X	X	X	X	X	X	X	X	X	X	X	X	X	X	X
6.	2302E DMA1 0204	YAMUNA.M	X	X	X	X	X	X	X	X	X	X	X	X	X	X	X
7.	2302E DPC10 201	SIMRAN.E	X	X	X	X	X	X	X	X	X	X	X	X	X	X	X
8.	2302E DPC10 202	BABY SHALINLL	X	X	X	X	X	X	X	X	X	X	X	X	X	X	X
9.	2302E DPC10 203	HEMA.G	X	X	X	X	X	X	X	X	X	X	X	X	X	X	X
10.	2302E DPC10 204	GOWSALYA.G	X	X	X	X	X	X	X	X	X	X	X	X	X	X	X
11.	2302E DPC10 205	ANUSUYA.D	X	X	X	X	X	X	X	X	X	X	X	X	X	X	X
12.	2302E DPC10 101	AMALRAJ.B	X	X	X	X	X	X	X	X	X	X	X	X	X	X	X
13.	2302E DBS10 201	PARIMALA.S	X	X	X	X	X	X	X	X	X	X	X	X	X	X	X
14.	2302E DBS10 202	PRIYADHARSH INI.P	X	X	X	X	X	X	X	X	X	X	X	X	X	X	X

HOD

School of Education
Ponnaiyah Ramajayam Institute of
Science & Technology (PRIST)
THANJAVUR - 613 403.

DEAN

School of Education
Ponnaiyah Ramajayam Institute of
Science & Technology (PRIST)
THANJAVUR - 613 403.

15.	2301E DCS10 201	PRADEEPA.R	X	X	X	X	X	X	X	X	X	X	X	X	X	X	X	X
16.	2301E DCS10 101	KARTHIK. M	X	X	X	X	X	X	X	X	X	X	X	X	X	X	X	X
17.	2302E DCO10 201	VEENA.P	X	X	X	X	X	X	X	X	X	X	X	X	X	X	X	X
18.	2302E DHI10 201	JAYANTHLD	X	X	X	X	X	X	X	X	X	X	X	X	X	X	X	X
19.	2302E DGO10 201	ABIRAMASUN DHARLS	X	X	X	X	X	X	X	X	X	X	X	X	X	X	X	X
20.	2302E DTA10 202	C.Amaravathi	X	X	X	X	X	X	X	X	X	X	X	X	X	X	X	X
21.	2302E DTA10 203	S.Anandhi	X	X	X	X	X	X	X	X	X	X	X	X	X	X	X	X
22.	2302E DTA10 204	N.Buvaneswari	X	X	X	X	X	X	X	X	X	X	X	X	X	X	X	X
23.	2302E DTA10 205	S.Juliet	X	X	X	X	X	X	X	X	X	X	X	X	X	X	X	X
24.	2302E DTA10 206	S.Jenifar	X	X	X	X	X	X	X	X	X	X	X	X	X	X	X	X
25.	2302E DTA10 207	X.Arockiya Mary	X	X	X	X	X	X	X	X	X	X	X	X	X	X	X	X
26.	2302E DTA10 208	R.Darathy	X	X	X	X	X	X	X	X	X	X	X	X	X	X	X	X
27.	2302E DTA10 209	B.Muthulakshmi	X	X	X	X	X	X	X	X	X	X	X	X	X	X	X	X
28.	2302E DEN10 102	S.Sumitra	X	X	X	X	X	X	X	X	X	X	X	X	X	X	X	X
29.	2302E DEN10 103	D.Vasumathi	X	X	X	X	X	X	X	X	X	X	X	X	X	X	X	X
30.	2302E DEN10 104	S.Divya	X	X	X	X	X	X	X	X	X	X	X	X	X	X	X	X
31.	2302E DEN10 105	V.Chitra	X	X	X	X	X	X	X	X	X	X	X	X	X	X	X	X

HOD

School of Education
Ponnaiyah Ramajayam Institute of
Science & Technology (PRIST)
THANJAVUR - 613 403.

DEAN

School of Education
Ponnaiyah Ramajayam Institute of
Science & Technology (PRIST)
THANJAVUR - 613 403.

32.	2302E DEN10 106	G.Nandhini	X	X	X	X	X	X	X	X	X	X	X	X	X	X	X	X
33.	2302E DEN10 107	J.Revathi	X	X	X	X	X	X	X	X	X	X	X	X	X	X	X	X
34.	2302E DEN10 108	J.Sangeetha	X	X	X	X	X	X	X	X	X	X	X	X	X	X	X	X
35.	2302E DEN10 109	T.Sasireka	X	X	X	X	X	X	X	X	X	X	X	X	X	X	X	X
36.	2302E DEN10 110	G.Lakshmi	X	X	X	X	X	X	X	X	X	X	X	X	X	X	X	X
37.	2302E DEN10 111	T.Sutha	X	X	X	X	X	X	X	X	X	X	X	X	X	X	X	X
38.	2302E DEN10 112	T.Indira	X	X	X	X	X	X	X	X	X	X	X	X	X	X	X	X
39.	230ED MA102 02	M.Krishnaveni	X	X	X	X	X	X	X	X	X	X	X	X	X	X	X	X
40.	230ED MA102 03	G.Regavathi	X	X	X	X	X	X	X	X	X	X	X	X	X	X	X	X
41.	230ED MA102 04	H. Jahabar Nachiya	X	X	X	X	X	X	X	X	X	X	X	X	X	X	X	X
42.	230ED MA102 05	V. Kiruba	X	X	X	X	X	X	X	X	X	X	X	X	X	X	X	X
43.	230ED MA102 06	K.Ambika	X	X	X	X	X	X	X	X	X	X	X	X	X	X	X	X
44.	230ED MA102 07	L.Angelomary	X	X	X	X	X	X	X	X	X	X	X	X	X	X	X	X
45.	230ED MA102 02	G.Saranya	X	X	X	X	X	X	X	X	X	X	X	X	X	X	X	X
46.	230ED MA102 03	R.Amuthakumari	X	X	X	X	X	X	X	X	X	X	X	X	X	X	X	X
47.	2302E DBS10 204	R.Kalaivani	X	X	X	X	X	X	X	X	X	X	X	X	X	X	X	X
48.	2302E DBS10 205	P.Kanmani	X	X	X	X	X	X	X	X	X	X	X	X	X	X	X	X



HOD

School of Education
Ponnaiyah Ramajayam Institute of
Science & Technology (PRIST)
THANJAVUR - 613 403.



DEAN

School of Education
Ponnaiyah Ramajayam Institute of
Science & Technology (PRIST)
THANJAVUR - 613 403.















49.	2302E DBS10 206	T.Meena	X	X	X	X	X	X	X	X	X	X	X	X	X	X	X	X
50.	2302E DBS10 207	K.Sathiyapriya	X	X	X	X	X	X	X	X	X	X	X	X	X	X	X	X
51.	2302M ED202 01	Jeipreethi kanggeyavelu.K	X	X	X	X	X	X	X	X	X	X	X	X	X	X	X	X
52.	2302M ED202 02	Noor nisha.A	X	X	X	X	X	X	X	X	X	X	X	X	X	X	X	X
53.	2302M ED202 03	Nivethitha.R	X	X	X	X	X	X	X	X	X	X	X	X	X	X	X	X
54.	2302M ED202 04	Mahalakshmi.R	X	X	X	X	X	X	X	X	X	X	X	X	X	X	X	X
55.	2302M ED202 05	Preethi.N	X	X	X	X	X	X	X	X	X	X	X	X	X	X	X	X
56.	2302M ED202 06	AbiramiR	X	X	X	X	X	X	X	X	X	X	X	X	X	X	X	X
57.	2302M ED202 07	P. Ganesan	X	X	X	X	X	X	X	X	X	X	X	X	X	X	X	X
58.	2302M ED202 08	V. JayaKumar	X	X	X	X	X	X	X	X	X	X	X	X	X	X	X	X
59.	2302M ED202 09	L. Mekala	X	X	X	X	X	X	X	X	X	X	X	X	X	X	X	X
60.	2302M ED202 10	S. Annapoorni	X	X	X	X	X	X	X	X	X	X	X	X	X	X	X	X
61.	2302M ED202 11	R. Bommi	X	X	X	X	X	X	X	X	X	X	X	X	X	X	X	X
62.	2302M ED202 12	J. Elavarasi	X	X	X	X	X	X	X	X	X	X	X	X	X	X	X	X
63.	2302M ED202 13	P. Ezhilarasi	X	X	X	X	X	X	X	X	X	X	X	X	X	X	X	X
64.	2302M ED202 14	K. Joice Mary	X	X	X	X	X	X	X	X	X	X	X	X	X	X	X	X

HOD

School of Education
Ponnaiyah Ramajayam Institute of
Science & Technology (PRIST)
THANJAVUR - 613 403.

DEAN

School of Education
Ponnaiyah Ramajayam Institute of
Science & Technology (PRIST)
THANJAVUR - 613 403.

65.	2302M ED202 15	P. Krishnapriya	X	X	X	X	X	X	X	X	X	X	X	X	X	X	X	X
66.	2302M ED202 16	T.Kumari	X	X	X	X	X	X	X	X	X	X	X	X	X	X	X	X
67.	2302M ED202 17	S.Manimekalai	X	X	X	X	X	X	X	X	X	X	X	X	X	X	X	X
68.	2302M ED202 18	M.Jeyarani	X	X	X	X	X	X	X	X	X	X	X	X	X	X	X	X
69.	2302M ED202 19	P.Selvarani	X	X	X	X	X	X	X	X	X	X	X	X	X	X	X	X
70.	2302M ED202 20	M.Suseela	X	X	X	X	X	X	X	X	X	X	X	X	X	X	X	X
71.	2302M ED202 21	A.Sirajinnisha	X	X	X	X	X	X	X	X	X	X	X	X	X	X	X	X
72.	2302M ED202 22	T.Sollararasan	X	X	X	X	X	X	X	X	X	X	X	X	X	X	X	X
73.	2302M ED202 23	S.Kavitha	X	X	X	X	X	X	X	X	X	X	X	X	X	X	X	X
74.	2302M ED202 24	T.Sumathi	X	X	X	X	X	X	X	X	X	X	X	X	X	X	X	X
75.	2302M ED202 25	A.T.Banu	X	X	X	X	X	X	X	X	X	X	X	X	X	X	X	X
Staff signature																		

HOD

School of Education
Ponnaiyah Ramajayam Institute of
Science & Technology (PRIST)
THANJAVUR - 613 403.

DEAN

School of Education
Ponnaiyah Ramajayam Institute of
Science & Technology (PRIST)
THANJAVUR - 613 403.



**PONNAIYAH RAMAJAYAM INSTITUTE OF
SCIENCE & TECHNOLOGY (PRIST)**

Declared as DEEMED-TO-BE-UNIVERSITY
U/s 3 of UGC Act, 1956

SCHOOL OF EDUCATION

Value Added Course

COURSE TITLE: MENTAL HEALTH

Students Attendance Date: (November - 2023)

Academic Year 2023 - 2024

S.No	Reg.No	Name	02	03	04	06	09	10	13	14	16	18	19	20	23	24	27
1.	2302E DTA10 201	MATHAVLR	X	X	X	X	X	X	X	X	X	X	X	X	X	X	X
2.	2302E DEN10 101	SUKENDRAN.R	X	X	X	X	X	X	X	X	X	X	X	X	X	X	X
3.	230ED MA102 01	KOWSALYA.M	X	X	X	X	X	X	X	X	X	X	X	X	X	X	X
4.	2301E DMA1 0202	KARTHIKA.K	X	X	X	X	X	X	X	X	X	X	X	X	X	X	X
5.	2302E DMA1 0203	UMA.K	X	X	X	X	X	X	X	X	X	X	X	X	X	X	X
6.	2302E DMA1 0204	YAMUNA.M	X	X	X	X	X	X	X	X	X	X	X	X	X	X	X
7.	2302E DPC10 201	SIMRAN.E	X	X	X	X	X	X	X	X	X	X	X	X	X	X	X
8.	2302E DPC10 202	BABY SHALIN.L	X	X	X	X	X	X	X	X	X	X	X	X	X	X	X
9.	2302E DPC10 203	HEMA.G	X	X	X	X	X	X	X	X	X	X	X	X	X	X	X
10.	2302E DPC10 204	GOWSALYA.G	X	X	X	X	X	X	X	X	X	X	X	X	X	X	X
11.	2302E DPC10 205	ANUSUYA.D	X	X	X	X	X	X	X	X	X	X	X	X	X	X	X
12.	2302E DPC10 101	AMALRAJ. B	X	X	X	X	X	X	X	X	X	X	X	X	X	X	X
13.	2302E DBS10 201	PARIMALA.S	X	X	X	X	X	X	X	X	X	X	X	X	X	X	X
14.	2302E DBS10 202	PRIYADHARSH INLP	X	X	X	X	X	X	X	X	X	X	X	X	X	X	X

HOD

School of Education
Ponnaiyah Ramajayam Institute of
Science & Technology (PRIST)
THANJAVUR - 613 403.

DEAN

School of Education
Ponnaiyah Ramajayam Institute of
Science & Technology (PRIST)
THANJAVUR - 613 403.

15.	2301E DCS10 201	PRADEEPA.R	X	X	X	X	X	X	X	X	X	X	X	X	X	X	X	X
16.	2301E DCS10 101	KARTHIK. M	X	X	X	X	X	X	X	X	X	X	X	X	X	X	X	X
17.	2302E DCO10 201	VEENA.P	X	X	X	X	X	X	X	X	X	X	X	X	X	X	X	X
18.	2302E DHI10 201	JAYANTHI.D	X	X	X	X	X	X	X	X	X	X	X	X	X	X	X	X
19.	2302E DGO10 201	ABIRAMASUN DHARIS	X	X	X	X	X	X	X	X	X	X	X	X	X	X	X	X
20.	2302E DTA10 202	C.Amaravathi	X	X	X	X	X	X	X	X	X	X	X	X	X	X	X	X
21.	2302E DTA10 203	S.Anandhi	X	X	X	X	X	X	X	X	X	X	X	X	X	X	X	X
22.	2302E DTA10 204	N.Buvaneswari	X	X	X	X	X	X	X	X	X	X	X	X	X	X	X	X
23.	2302E DTA10 205	S.Juliet	X	X	X	X	X	X	X	X	X	X	X	X	X	X	X	X
24.	2302E DTA10 206	S.Jenifar	X	X	X	X	X	X	X	X	X	X	X	X	X	X	X	X
25.	2302E DTA10 207	X.Arockiya Mary	X	X	X	X	X	X	X	X	X	X	X	X	X	X	X	X
26.	2302E DTA10 208	R.Darathy	X	X	X	X	X	X	X	X	X	X	X	X	X	X	X	X
27.	2302E DTA10 209	B.Muthulakshmi	X	X	X	X	X	X	X	X	X	X	X	X	X	X	X	X
28.	2302E DEN10 102	S.Sumitra	X	X	X	X	X	X	X	X	X	X	X	X	X	X	X	X
29.	2302E DEN10 103	D.Vasumathi	X	X	X	X	X	X	X	X	X	X	X	X	X	X	X	X
30.	2302E DEN10 104	S.Divya	X	X	X	X	X	X	X	X	X	X	X	X	X	X	X	X
31.	2302E DEN10 105	V.Chitra	X	X	X	X	X	X	X	X	X	X	X	X	X	X	X	X

HOD

School of Education
Ponnaiyah Ramajayam Institute of
Science & Technology (PRIST)
THANJAVUR - 613 403.

DEAN

School of Education
Ponnaiyah Ramajayam Institute of
Science & Technology (PRIST)
THANJAVUR - 613

32.	2302E DEN10 106	G.Nandhini	X	X	X	X	X	X	X	X	X	X	X	X	X	X	X	X
33.	2302E DEN10 107	J.Revathi	X	X	X	X	X	X	X	X	X	X	X	X	X	X	X	X
34.	2302E DEN10 108	J.Sangeetha	X	X	X	X	X	X	X	X	X	X	X	X	X	X	X	X
35.	2302E DEN10 109	T.Sasireka	X	X	X	X	X	X	X	X	X	X	X	X	X	X	X	X
36.	2302E DEN10 110	G.Lakshmi	X	X	X	X	X	X	X	X	X	X	X	X	X	X	X	X
37.	2302E DEN10 111	T.Sutha	X	X	X	X	X	X	X	X	X	X	X	X	X	X	X	X
38.	2302E DEN10 112	T.Indira	X	X	X	X	X	X	X	X	X	X	X	X	X	X	X	X
39.	230ED MA102 02	M.Krishnaveni	X	X	X	X	X	X	X	X	X	X	X	X	X	X	X	X
40.	230ED MA102 03	G.Regavathi	X	X	X	X	X	X	X	X	X	X	X	X	X	X	X	X
41.	230ED MA102 04	H. Jahabar Nachiya	X	X	X	X	X	X	X	X	X	X	X	X	X	X	X	X
42.	230ED MA102 05	V. Kiruba	X	X	X	X	X	X	X	X	X	X	X	X	X	X	X	X
43.	230ED MA102 06	K.Ambika	X	X	X	X	X	X	X	X	X	X	X	X	X	X	X	X
44.	230ED MA102 07	L.Angelomary	X	X	X	X	X	X	X	X	X	X	X	X	X	X	X	X
45.	230ED MA102 02	G.Saranya	X	X	X	X	X	X	X	X	X	X	X	X	X	X	X	X
46.	230ED MA102 03	R.Amuthakumari	X	X	X	X	X	X	X	X	X	X	X	X	X	X	X	X
47.	2302E DBS10 204	R.Kalaivani	X	X	X	X	X	X	X	X	X	X	X	X	X	X	X	X
48.	2302E DBS10 205	P.Kanmani	X	X	X	X	X	X	X	X	X	X	X	X	X	X	X	X

HOD

School of Education
Ponnaiyah Ramajayam Institute of
Science & Technology (PRIST)
THANJAVUR - 613 403.

DEAN

School of Education
Ponnaiyah Ramajayam Institute of
Science & Technology (PRIST)
THANJAVUR - 613















49.	2302E DBS10 206	T.Meena	X	X	X	X	X	X	X	X	X	X	X	X	X	X	X	X
50.	2302E DBS10 207	K.Sathiyapriya	X	X	X	X	X	X	X	X	X	X	X	X	X	X	X	X
51.	2302M ED202 01	Jeipreethi kanggeyavelu.K	X	X	X	X	X	X	X	X	X	X	X	X	X	X	X	X
52.	2302M ED202 02	Noor nisha.A	X	X	X	X	X	X	X	X	X	X	X	X	X	X	X	X
53.	2302M ED202 03	Nivethitha.R	X	X	X	X	X	X	X	X	X	X	X	X	X	X	X	X
54.	2302M ED202 04	Mahalakshmi.R	X	X	X	X	X	X	X	X	X	X	X	X	X	X	X	X
55.	2302M ED202 05	Preethi.N	X	X	X	X	X	X	X	X	X	X	X	X	X	X	X	X
56.	2302M ED202 06	AbiramiR	X	X	X	X	X	X	X	X	X	X	X	X	X	X	X	X
57.	2302M ED202 07	P. Ganesan	X	X	X	X	X	X	X	X	X	X	X	X	X	X	X	X
58.	2302M ED202 08	V. JayaKumar	X	X	X	X	X	X	X	X	X	X	X	X	X	X	X	X
59.	2302M ED202 09	L. Mekala	X	X	X	X	X	X	X	X	X	X	X	X	X	X	X	X
60.	2302M ED202 10	S. Annapoorni	X	X	X	X	X	X	X	X	X	X	X	X	X	X	X	X
61.	2302M ED202 11	R. Bommi	X	X	X	X	X	X	X	X	X	X	X	X	X	X	X	X
62.	2302M ED202 12	J. Elavarasi	X	X	X	X	X	X	X	X	X	X	X	X	X	X	X	X
63.	2302M ED202 13	P. Ezhilarasi	X	X	X	X	X	X	X	X	X	X	X	X	X	X	X	X
64.	2302M ED202 14	K. Joice Mary	X	X	X	X	X	X	X	X	X	X	X	X	X	X	X	X

HOD

School of Education
Ponnaiyah Ramajayam Institute of
Science & Technology (PRIST)
THANJAVUR - 613 403.

DEAN

School of Education
Ponnaiyah Ramajayam Institute of
Science & Technology (PRIST)
THANJAVUR - 613 403.

65.	2302M ED202 15	P. Krishnapriya	X	X	X	X	X	X	X	X	X	X	X	X	X	X	X	X
66.	2302M ED202 16	T.Kumari	X	X	X	X	X	X	X	X	X	X	X	X	X	X	X	X
67.	2302M ED202 17	S.Manimekalai	X	X	X	X	X	X	X	X	X	X	X	X	X	X	X	X
68.	2302M ED202 18	M.Jeyarani	X	X	X	X	X	X	X	X	X	X	X	X	X	X	X	X
69.	2302M ED202 19	P.Selvarani	X	X	X	X	X	X	X	X	X	X	X	X	X	X	X	X
70.	2302M ED202 20	M.Suseela	X	X	X	X	X	X	X	X	X	X	X	X	X	X	X	X
71.	2302M ED202 21	A.Sirajinnisha	X	X	X	X	X	X	X	X	X	X	X	X	X	X	X	X
72.	2302M ED202 22	T.Sollararasan	X	X	X	X	X	X	X	X	X	X	X	X	X	X	X	X
73.	2302M ED202 23	S.Kavitha	X	X	X	X	X	X	X	X	X	X	X	X	X	X	X	X
74.	2302M ED202 24	T.Sumathi	X	X	X	X	X	X	X	X	X	X	X	X	X	X	X	X
75.	2302M ED202 25	A.T.Banu	X	X	X	X	X	X	X	X	X	X	X	X	X	X	X	X
Staff signature																		

HOD

School of Education
Ponnaiyah Ramajayam Institute of
Science & Technology (PRIST)
THANJAVUR - 613 403.

DEAN

School of Education
Ponnaiyah Ramajayam Institute of
Science & Technology (PRIST)
THANJAVUR - 613 403.



**PONNAIYAH RAMAJAYAM INSTITUTE OF
SCIENCE & TECHNOLOGY (PRIST)**

Declared as DEEMED-TO-BE UNIVERSITY
U/s 3 of UGC Act, 1956

SCHOOL OF EDUCATION
Value Added Course
COURSE TITLE: ENVIRONMENTAL AWARENESS
Students Attendance Date: (September - 2023)
Academic Year 2023 - 2024

S.No	Reg.No	Name	07	08	09	10	11	12	13	14	16	18	19	20	23	24	27
1.	2302E DTA10 201	MATHAVI.R	X	X	X	X	X	X	X	X	X	X	X	X	X	X	X
2.	2302E DEN10 101	SUKENDRAN.R	X	X	X	X	X	X	X	X	X	X	X	X	X	X	X
3.	230ED MA102 01	KOWSALYA.M	X	X	X	X	X	X	X	X	X	X	X	X	X	X	X
4.	2301E DMA1 0202	KARTHIKA.K	X	X	X	X	X	X	X	X	X	X	X	X	X	X	X
5.	2302E DMA1 0203	UMA.K	X	X	X	X	X	X	X	X	X	X	X	X	X	X	X
6.	2302E DMA1 0204	YAMUNA.M	X	X	X	X	X	X	X	X	X	X	X	X	X	X	X
7.	2302E DPC10 201	SIMRAN.E	X	X	X	X	X	X	X	X	X	X	X	X	X	X	X
8.	2302E DPC10 202	BABY SHALINI.L	X	X	X	X	X	X	X	X	X	X	X	X	X	X	X
9.	2302E DPC10 203	HEMA.G	X	X	X	X	X	X	X	X	X	X	X	X	X	X	X
10.	2302E DPC10 204	GOWSALYA.G	X	X	X	X	X	X	X	X	X	X	X	X	X	X	X
11.	2302E DPC10 205	ANUSUYA.D	X	X	X	X	X	X	X	X	X	X	X	X	X	X	X
12.	2302E DPC10 101	AMALRAJ. B	X	X	X	X	X	X	X	X	X	X	X	X	X	X	X
13.	2302E DBS10 201	PARIMALA.S	X	X	X	X	X	X	X	X	X	X	X	X	X	X	X
14.	2302E DBS10 202	PRIYADHARSH INLP	X	X	X	X	X	X	X	X	X	X	X	X	X	X	X

HOD

School of Education
Ponnaiyah Ramajayam Institute of
Science & Technology (PRIST)
THANJAVUR - 613 403.

DEAN

School of Education
Ponnaiyah Ramajayam Institute of
Science & Technology (PRIST)
THANJAVUR - 613 403.

15.	2301E DCS10 201	PRADEEPA.R	X	X	X	X	X	X	X	X	X	X	X	X	X	X	X	X
16.	2301E DCS10 101	KARTHIK. M	X	X	X	X	X	X	X	X	X	X	X	X	X	X	X	X
17.	2302E DCO10 201	VEENA.P	X	X	X	X	X	X	X	X	X	X	X	X	X	X	X	X
18.	2302E DHI10 201	JAYANTHLD	X	X	X	X	X	X	X	X	X	X	X	X	X	X	X	X
19.	2302E DGO10 201	ABIRAMASUN DHARLS	X	X	X	X	X	X	X	X	X	X	X	X	X	X	X	X
20.	2302E DTA10 202	C.Amaravathi	X	X	X	X	X	X	X	X	X	X	X	X	X	X	X	X
21.	2302E DTA10 203	S.Anandhi	X	X	X	X	X	X	X	X	X	X	X	X	X	X	X	X
22.	2302E DTA10 204	N.Buvaneswari	X	X	X	X	X	X	X	X	X	X	X	X	X	X	X	X
23.	2302E DTA10 205	S.Juliet	X	X	X	X	X	X	X	X	X	X	X	X	X	X	X	X
24.	2302E DTA10 206	S.Jenifar	X	X	X	X	X	X	X	X	X	X	X	X	X	X	X	X
25.	2302E DTA10 207	X.Arockiya Mary	X	X	X	X	X	X	X	X	X	X	X	X	X	X	X	X
26.	2302E DTA10 208	R.Darathy	X	X	X	X	X	X	X	X	X	X	X	X	X	X	X	X
27.	2302E DTA10 209	B.Muthulakshmi	X	X	X	X	X	X	X	X	X	X	X	X	X	X	X	X
28.	2302E DEN10 102	S.Sumitra	X	X	X	X	X	X	X	X	X	X	X	X	X	X	X	X
29.	2302E DEN10 103	D.Vasumathi	X	X	X	X	X	X	X	X	X	X	X	X	X	X	X	X
30.	2302E DEN10 104	S.Divya	X	X	X	X	X	X	X	X	X	X	X	X	X	X	X	X
31.	2302E DEN10 105	V.Chitra	X	X	X	X	X	X	X	X	X	X	X	X	X	X	X	X

HOD

School of Education
Ponnaiyah Ramajayam Institute of
Science & Technology (PRIST)
THANJAVUR - 613 403.

DEAN

School of Education
Ponnaiyah Ramajayam Institute of
Science & Technology (PRIST)
THANJAVUR - 613 403.

32.	2302E DEN10 106	G.Nandhini	X	X	X	X	X	X	X	X	X	X	X	X	X	X	X	X
33.	2302E DEN10 107	J.Revathi	X	X	X	X	X	X	X	X	X	X	X	X	X	X	X	X
34.	2302E DEN10 108	J.Sangeetha	X	X	X	X	X	X	X	X	X	X	X	X	X	X	X	X
35.	2302E DEN10 109	T.Sasireka	X	X	X	X	X	X	X	X	X	X	X	X	X	X	X	X
36.	2302E DEN10 110	G.Lakshmi	X	X	X	X	X	X	X	X	X	X	X	X	X	X	X	X
37.	2302E DEN10 111	T.Sutha	X	X	X	X	X	X	X	X	X	X	X	X	X	X	X	X
38.	2302E DEN10 112	T.Indira	X	X	X	X	X	X	X	X	X	X	X	X	X	X	X	X
39.	230ED MA102 02	M.Krishnaveni	X	X	X	X	X	X	X	X	X	X	X	X	X	X	X	X
40.	230ED MA102 03	G.Regavathi	X	X	X	X	X	X	X	X	X	X	X	X	X	X	X	X
41.	230ED MA102 04	H. Jahabar Nachiya	X	X	X	X	X	X	X	X	X	X	X	X	X	X	X	X
42.	230ED MA102 05	V. Kiruba	X	X	X	X	X	X	X	X	X	X	X	X	X	X	X	X
43.	230ED MA102 06	K.Ambika	X	X	X	X	X	X	X	X	X	X	X	X	X	X	X	X
44.	230ED MA102 07	L.Angelomary	X	X	X	X	X	X	X	X	X	X	X	X	X	X	X	X
45.	230ED MA102 02	G.Saranya	X	X	X	X	X	X	X	X	X	X	X	X	X	X	X	X
46.	230ED MA102 03	R.Amuthakumari	X	X	X	X	X	X	X	X	X	X	X	X	X	X	X	X
47.	2302E DBS10 204	R.Kalaivani	X	X	X	X	X	X	X	X	X	X	X	X	X	X	X	X
48.	2302E DBS10 205	P.Kanmani	X	X	X	X	X	X	X	X	X	X	X	X	X	X	X	X

HOD

School of Education
Ponnaiyah Ramajayam Institute of
Science & Technology (PRIST)
THANJAVUR - 613 403.

DEAN

School of Education
Ponnaiyah Ramajayam Institute of
Science & Technology (PRIST)
THANJAVUR - 613 403.

49.	2302E DBS10 206	T.Meena	X	X	X	X	X	X	X	X	X	X	X	X	X	X	X	X
50.	2302E DBS10 207	K.Sathiyapriya	X	X	X	X	X	X	X	X	X	X	X	X	X	X	X	X
51.	2302M ED202 01	Jeipreethi kanggeyavelu.K	X	X	X	X	X	X	X	X	X	X	X	X	X	X	X	X
52.	2302M ED202 02	Noor nisha.A	X	X	X	X	X	X	X	X	X	X	X	X	X	X	X	X
53.	2302M ED202 03	Nivethitha.R	X	X	X	X	X	X	X	X	X	X	X	X	X	X	X	X
54.	2302M ED202 04	Mahalakshmi.R	X	X	X	X	X	X	X	X	X	X	X	X	X	X	X	X
55.	2302M ED202 05	Preethi.N	X	X	X	X	X	X	X	X	X	X	X	X	X	X	X	X
56.	2302M ED202 06	AbiramiR	X	X	X	X	X	X	X	X	X	X	X	X	X	X	X	X
57.	2302M ED202 07	P. Ganesan	X	X	X	X	X	X	X	X	X	X	X	X	X	X	X	X
58.	2302M ED202 08	V. JayaKumar	X	X	X	X	X	X	X	X	X	X	X	X	X	X	X	X
59.	2302M ED202 09	L. Mekala	X	X	X	X	X	X	X	X	X	X	X	X	X	X	X	X
60.	2302M ED202 10	S. Annapoorni	X	X	X	X	X	X	X	X	X	X	X	X	X	X	X	X
61.	2302M ED202 11	R. Bommi	X	X	X	X	X	X	X	X	X	X	X	X	X	X	X	X
62.	2302M ED202 12	J. Elavarasi	X	X	X	X	X	X	X	X	X	X	X	X	X	X	X	X
63.	2302M ED202 13	P. Ezhilarasi	X	X	X	X	X	X	X	X	X	X	X	X	X	X	X	X
64.	2302M ED202 14	K. Joice Mary	X	X	X	X	X	X	X	X	X	X	X	X	X	X	X	X

HOD

School of Education
Ponnaiyah Ramajayam Institute of
Science & Technology (PRIST)
THANJAVUR - 613 403.

DEAN

School of Education
Ponnaiyah Ramajayam Institute of
Science & Technology (PRIST)
THANJAVUR - Page 914 of 1367

65.	2302M ED202 15	P. Krishnapriya	X	X	X	X	X	X	X	X	X	X	X	X	X	X	X	X
66.	2302M ED202 16	T.Kumari	X	X	X	X	X	X	X	X	X	X	X	X	X	X	X	X
67.	2302M ED202 17	S.Manimekalai	X	X	X	X	X	X	X	X	X	X	X	X	X	X	X	X
68.	2302M ED202 18	M.Jeyarani	X	X	X	X	X	X	X	X	X	X	X	X	X	X	X	X
69.	2302M ED202 19	P.Selvarani	X	X	X	X	X	X	X	X	X	X	X	X	X	X	X	X
70.	2302M ED202 20	M.Suseela	X	X	X	X	X	X	X	X	X	X	X	X	X	X	X	X
71.	2302M ED202 21	A.Sirajinnisha	X	X	X	X	X	X	X	X	X	X	X	X	X	X	X	X
72.	2302M ED202 22	T.Sollararasan	X	X	X	X	X	X	X	X	X	X	X	X	X	X	X	X
73.	2302M ED202 23	S.Kavitha	X	X	X	X	X	X	X	X	X	X	X	X	X	X	X	X
74.	2302M ED202 24	T.Sumathi	X	X	X	X	X	X	X	X	X	X	X	X	X	X	X	X
75.	2302M ED202 25	A.T.Banu	X	X	X	X	X	X	X	X	X	X	X	X	X	X	X	X
Staff signature			சு	சு	சு	சு	சு	சு	சு	சு	சு	சு	சு	சு	சு	சு	சு	சு

HOD
 School of Education
 Ponnaiyah Ramajayam Institute of
 Science & Technology (PRIST)
 THANJAVUR - 613 403.

DEAN
 School of Education
 Ponnaiyah Ramajayam Institute of
 Science & Technology (PRIST)
 THANJAVUR - 613 402.



**PONNAIYAH RAMAJAYAM INSTITUTE OF
SCIENCE & TECHNOLOGY (PRIST)**

Declared as DEEMED-TO-BE-UNIVERSITY
U/s 3 of UDC Act, 1958

SCHOOL OF EDUCATION
Value Added Course
COURSE TITLE: ENVIRONMENTAL AWARENESS
Students Attendance Date: (October - 2023)
Academic Year 2023 - 2024

S.No	Reg.No	Name	02	03	04	06	09	10	13	14	16	18	19	20	23	24	27
1.	2302E DTA10 201	MATHAVI.R	X	X	X	X	X	X	X	X	X	X	X	X	X	X	X
2.	2302E DEN10 101	SUKENDRAN.R	X	X	X	X	X	X	X	X	X	X	X	X	X	X	X
3.	230ED MA102 01	KOWSALYA.M	X	X	X	X	X	X	X	X	X	X	X	X	X	X	X
4.	2301E DMA1 0202	KARTHIKA.K	X	X	X	X	X	X	X	X	X	X	X	X	X	X	X
5.	2302E DMA1 0203	UMA.K	X	X	X	X	X	X	X	X	X	X	X	X	X	X	X
6.	2302E DMA1 0204	YAMUNA.M	X	X	X	X	X	X	X	X	X	X	X	X	X	X	X
7.	2302E DPC10 201	SIMRAN.E	X	X	X	X	X	X	X	X	X	X	X	X	X	X	X
8.	2302E DPC10 202	BABY SHALINI.L	X	X	X	X	X	X	X	X	X	X	X	X	X	X	X
9.	2302E DPC10 203	HEMA.G	X	X	X	X	X	X	X	X	X	X	X	X	X	X	X
10.	2302E DPC10 204	GOWSALYA.G	X	X	X	X	X	X	X	X	X	X	X	X	X	X	X
11.	2302E DPC10 205	ANUSUYA.D	X	X	X	X	X	X	X	X	X	X	X	X	X	X	X
12.	2302E DPC10 101	AMALRAJ. B	X	X	X	X	X	X	X	X	X	X	X	X	X	X	X
13.	2302E DBS10 201	PARIMALA.S	X	X	X	X	X	X	X	X	X	X	X	X	X	X	X
14.	2302E DBS10 202	PRIYADHARSH INLP	X	X	X	X	X	X	X	X	X	X	X	X	X	X	X

HOD

School of Education
Ponnaiyah Ramajayam Institute of
Science & Technology (PRIST)
THANAVUR - 613 403.

DEAN

School of Education
Ponnaiyah Ramajayam Institute of
Science & Technology (PRIST)
THANAVUR - 613 403.

15.	2301E DCS10 201	PRADEEPA.R	X	X	X	X	X	X	X	X	X	X	X	X	X	X	X	X
16.	2301E DCS10 101	KARTHIK. M	X	X	X	X	X	X	X	X	X	X	X	X	X	X	X	X
17.	2302E DCO10 201	VEENA.P	X	X	X	X	X	X	X	X	X	X	X	X	X	X	X	X
18.	2302E DHI10 201	JAYANTHI.D	X	X	X	X	X	X	X	X	X	X	X	X	X	X	X	X
19.	2302E DGO10 201	ABIRAMASUN DHARLS	X	X	X	X	X	X	X	X	X	X	X	X	X	X	X	X
20.	2302E DTA10 202	C.Amaravathi	X	X	X	X	X	X	X	X	X	X	X	X	X	X	X	X
21.	2302E DTA10 203	S.Anandhi	X	X	X	X	X	X	X	X	X	X	X	X	X	X	X	X
22.	2302E DTA10 204	N.Buveneswari	X	X	X	X	X	X	X	X	X	X	X	X	X	X	X	X
23.	2302E DTA10 205	S.Juliet	X	X	X	X	X	X	X	X	X	X	X	X	X	X	X	X
24.	2302E DTA10 206	S.Jenifar	X	X	X	X	X	X	X	X	X	X	X	X	X	X	X	X
25.	2302E DTA10 207	X.Arockiya Mary	X	X	X	X	X	X	X	X	X	X	X	X	X	X	X	X
26.	2302E DTA10 208	R.Dsrathy	X	X	X	X	X	X	X	X	X	X	X	X	X	X	X	X
27.	2302E DTA10 209	B.Muthulakshmi	X	X	X	X	X	X	X	X	X	X	X	X	X	X	X	X
28.	2302E DEN10 102	S.Sumitra	X	X	X	X	X	X	X	X	X	X	X	X	X	X	X	X
29.	2302E DEN10 103	D.Vasumathi	X	X	X	X	X	X	X	X	X	X	X	X	X	X	X	X
30.	2302E DEN10 104	S.Divya	X	X	X	X	X	X	X	X	X	X	X	X	X	X	X	X
31.	2302E DEN10 105	V.Chitra	X	X	X	X	X	X	X	X	X	X	X	X	X	X	X	X



HOD

School of Education
Ponnaiyah Ramajayam Institute of
Science & Technology (PRIST)
THANJAVUR - 613 403.



DEAN

School of Education
Ponnaiyah Ramajayam Institute of
Science & Technology (PRIST)
THANJAVUR - 613 403.

32.	2302E DEN10 106	G.Nandhini	X	X	X	X	X	X	X	X	X	X	X	X	X	X	X	X
33.	2302E DEN10 107	J.Revathi	X	X	X	X	X	X	X	X	X	X	X	X	X	X	X	X
34.	2302E DEN10 108	J.Sangeetha	X	X	X	X	X	X	X	X	X	X	X	X	X	X	X	X
35.	2302E DEN10 109	T.Sasireka	X	X	X	X	X	X	X	X	X	X	X	X	X	X	X	X
36.	2302E DEN10 110	G.Lakshmi	X	X	X	X	X	X	X	X	X	X	X	X	X	X	X	X
37.	2302E DEN10 111	T.Sutha	X	X	X	X	X	X	X	X	X	X	X	X	X	X	X	X
38.	2302E DEN10 112	T.Indira	X	X	X	X	X	X	X	X	X	X	X	X	X	X	X	X
39.	230ED MA102 02	M.Krishnaveni	X	X	X	X	X	X	X	X	X	X	X	X	X	X	X	X
40.	230ED MA102 03	G.Regavathi	X	X	X	X	X	X	X	X	X	X	X	X	X	X	X	X
41.	230ED MA102 04	H. Jahabar Nachiya	X	X	X	X	X	X	X	X	X	X	X	X	X	X	X	X
42.	230ED MA102 05	V. Kiruba	X	X	X	X	X	X	X	X	X	X	X	X	X	X	X	X
43.	230ED MA102 06	K.Ambika	X	X	X	X	X	X	X	X	X	X	X	X	X	X	X	X
44.	230ED MA102 07	L.Angelomary	X	X	X	X	X	X	X	X	X	X	X	X	X	X	X	X
45.	230ED MA102 02	G.Saranya	X	X	X	X	X	X	X	X	X	X	X	X	X	X	X	X
46.	230ED MA102 03	R.Amuthakumari	X	X	X	X	X	X	X	X	X	X	X	X	X	X	X	X
47.	2302E DBS10 204	R.Kalaivani	X	X	X	X	X	X	X	X	X	X	X	X	X	X	X	X
48.	2302E DBS10 205	P.Kanmani	X	X	X	X	X	X	X	X	X	X	X	X	X	X	X	X



HOD

School of Education
Ponnaiyah Ramajayam Institute of
Science & Technology (PRIST)
THANJAVUR - 613 403



DEAN

School of Education
Ponnaiyah Ramajayam Institute of
Science & Technology (PRIST)
THANJAVUR - 613 403

49.	2302E DBS10 206	T.Meena	X	X	X	X	X	X	X	X	X	X	X	X	X	X	X
50.	2302E DBS10 207	K.Sathyapriya	X	X	X	X	X	X	X	X	X	X	X	X	X	X	X
51.	2302M ED202 01	Jeipreethi kanggeyavelu.K	X	X	X	X	X	X	X	X	X	X	X	X	X	X	X
52.	2302M ED202 02	Noor nisha.A	X	X	X	X	X	X	X	X	X	X	X	X	X	X	X
53.	2302M ED202 03	Nivethitha.R	X	X	X	X	X	X	X	X	X	X	X	X	X	X	X
54.	2302M ED202 04	Mahalakshmi.R	X	X	X	X	X	X	X	X	X	X	X	X	X	X	X
55.	2302M ED202 05	Preethi.N	X	X	X	X	X	X	X	X	X	X	X	X	X	X	X
56.	2302M ED202 06	AbiramiR	X	X	X	X	X	X	X	X	X	X	X	X	X	X	X
57.	2302M ED202 07	P. Ganesan	X	X	X	X	X	X	X	X	X	X	X	X	X	X	X
58.	2302M ED202 08	V. JayaKumar	X	X	X	X	X	X	X	X	X	X	X	X	X	X	X
59.	2302M ED202 09	L. Mekala	X	X	X	X	X	X	X	X	X	X	X	X	X	X	X
60.	2302M ED202 10	S. Annapoorni	X	X	X	X	X	X	X	X	X	X	X	X	X	X	X
61.	2302M ED202 11	R. Bommi	X	X	X	X	X	X	X	X	X	X	X	X	X	X	X
62.	2302M ED202 12	J. Elavarasi	X	X	X	X	X	X	X	X	X	X	X	X	X	X	X
63.	2302M ED202 13	P. Ezhilarasi	X	X	X	X	X	X	X	X	X	X	X	X	X	X	X
64.	2302M ED202 14	K. Joice Mary	X	X	X	X	X	X	X	X	X	X	X	X	X	X	X



HOD

School of Education
Ponnaiyah Ramajayam Institute of
Science & Technology (PRIST)
THANJAVUR - 613 003



DEAN

School of Education
Ponnaiyah Ramajayam Institute of
Science & Technology (PRIST)
THANJAVUR - 613 003

65.	2302M ED202 15	P. Krishnapriya	X	X	X	X	X	X	X	X	X	X	X	X	X	X	X	X
66.	2302M ED202 16	T.Kumari	X	X	X	X	X	X	X	X	X	X	X	X	X	X	X	X
67.	2302M ED202 17	S.Manimekalai	X	X	X	X	X	X	X	X	X	X	X	X	X	X	X	X
68.	2302M ED202 18	M.Jeyarani	X	X	X	X	X	X	X	X	X	X	X	X	X	X	X	X
69.	2302M ED202 19	P.Selvarani	X	X	X	X	X	X	X	X	X	X	X	X	X	X	X	X
70.	2302M ED202 20	M.Suseela	X	X	X	X	X	X	X	X	X	X	X	X	X	X	X	X
71.	2302M ED202 21	A.Sirajinnisha	X	X	X	X	X	X	X	X	X	X	X	X	X	X	X	X
72.	2302M ED202 22	T.Sollararasan	X	X	X	X	X	X	X	X	X	X	X	X	X	X	X	X
73.	2302M ED202 23	S.Kavitha	X	X	X	X	X	X	X	X	X	X	X	X	X	X	X	X
74.	2302M ED202 24	T.Sumathi	X	X	X	X	X	X	X	X	X	X	X	X	X	X	X	X
75.	2302M ED202 25	A.T.Banu	X	X	X	X	X	X	X	X	X	X	X	X	X	X	X	X
Staff signature			<i>[Signature]</i>	<i>[Signature]</i>	<i>[Signature]</i>	<i>[Signature]</i>	<i>[Signature]</i>	<i>[Signature]</i>	<i>[Signature]</i>	<i>[Signature]</i>	<i>[Signature]</i>	<i>[Signature]</i>	<i>[Signature]</i>	<i>[Signature]</i>	<i>[Signature]</i>	<i>[Signature]</i>	<i>[Signature]</i>	<i>[Signature]</i>

HOD
 School of Education
 Ponnaiyah Ramajayam Institute of
 Science & Technology (PRIST)
 THANJAVUR - 613 403.

DEAN
 School of Education
 Ponnaiyah Ramajayam Institute of
 Science & Technology (PRIST)
 THANJAVUR - 613 403.



**PONNAIYAH RAMAJAYAM INSTITUTE OF
SCIENCE & TECHNOLOGY (PRIST)**

Declared as DEEMED-TO-BE-UNIVERSITY
U/s 3 of UGC Act, 1956

SCHOOL OF EDUCATION
Value Added Course
COURSE TITLE: ENVIRONMENTAL AWARENESS
Students Attendance Date: (November - 2023)
Academic Year 2023 - 2024

S.No	Reg.No	Name	02	03	04	06	09	10	13	14	16	18	19	20	23	24	27
1.	2302E DTA10 201	MATHAVLR	X	X	X	X	X	X	X	X	X	X	X	X	X	X	X
2.	2302E DEN10 101	SUKENDRAN.R	X	X	X	X	X	X	X	X	X	X	X	X	X	X	X
3.	230ED MA102 01	KOWSALYA.M	X	X	X	X	X	X	X	X	X	X	X	X	X	X	X
4.	2301E DMA1 0202	KARTHIKA.K	X	X	X	X	X	X	X	X	X	X	X	X	X	X	X
5.	2302E DMA1 0203	UMA.K	X	X	X	X	X	X	X	X	X	X	X	X	X	X	X
6.	2302E DMA1 0204	YAMUNA.M	X	X	X	X	X	X	X	X	X	X	X	X	X	X	X
7.	2302E DPC10 201	SIMRAN.E	X	X	X	X	X	X	X	X	X	X	X	X	X	X	X
8.	2302E DPC10 202	BABY SHALINLL	X	X	X	X	X	X	X	X	X	X	X	X	X	X	X
9.	2302E DPC10 203	HEMA.G	X	X	X	X	X	X	X	X	X	X	X	X	X	X	X
10.	2302E DPC10 204	GOWSALYA.G	X	X	X	X	X	X	X	X	X	X	X	X	X	X	X
11.	2302E DPC10 205	ANUSUYA.D	X	X	X	X	X	X	X	X	X	X	X	X	X	X	X
12.	2302E DPC10 101	AMALRAJ. B	X	X	X	X	X	X	X	X	X	X	X	X	X	X	X
13.	2302E DBS10 201	PARIMALA.S	X	X	X	X	X	X	X	X	X	X	X	X	X	X	X
14.	2302E DBS10 202	PRIYADHARSH INLP	X	X	X	X	X	X	X	X	X	X	X	X	X	X	X

HOD

School of Education
Ponnaiyah Ramajayam Institute of
Science & Technology (PRIST)
THANJAVUR - 613 403.

DEAN

School of Education
Ponnaiyah Ramajayam Institute of
Science & Technology (PRIST)
THANJAVUR - 613 403.

15.	2301E DCS10 201	PRADEEPA.R	X	X	X	X	X	X	X	X	X	X	X	X	X	X	X	X
16.	2301E DCS10 101	KARTHIK. M	X	X	X	X	X	X	X	X	X	X	X	X	X	X	X	X
17.	2302E DCO10 201	VEENA.P	X	X	X	X	X	X	X	X	X	X	X	X	X	X	X	X
18.	2302E DHI10 201	JAYANTHLD	X	X	X	X	X	X	X	X	X	X	X	X	X	X	X	X
19.	2302E DGO10 201	ABIRAMASUN DHARLS	X	X	X	X	X	X	X	X	X	X	X	X	X	X	X	X
20.	2302E DTA10 202	C.Amaravathi	X	X	X	X	X	X	X	X	X	X	X	X	X	X	X	X
21.	2302E DTA10 203	S.Anandhi	X	X	X	X	X	X	X	X	X	X	X	X	X	X	X	X
22.	2302E DTA10 204	N.Buveneswari	X	X	X	X	X	X	X	X	X	X	X	X	X	X	X	X
23.	2302E DTA10 205	S.Juliet	X	X	X	X	X	X	X	X	X	X	X	X	X	X	X	X
24.	2302E DTA10 206	S.Jenifar	X	X	X	X	X	X	X	X	X	X	X	X	X	X	X	X
25.	2302E DTA10 207	X.Arockiya Mary	X	X	X	X	X	X	X	X	X	X	X	X	X	X	X	X
26.	2302E DTA10 208	R.Darathy	X	X	X	X	X	X	X	X	X	X	X	X	X	X	X	X
27.	2302E DTA10 209	B.Muthulakshmi	X	X	X	X	X	X	X	X	X	X	X	X	X	X	X	X
28.	2302E DEN10 102	S.Sumitra	X	X	X	X	X	X	X	X	X	X	X	X	X	X	X	X
29.	2302E DEN10 103	D.Vasumathi	X	X	X	X	X	X	X	X	X	X	X	X	X	X	X	X
30.	2302E DEN10 104	S.Divya	X	X	X	X	X	X	X	X	X	X	X	X	X	X	X	X
31.	2302E DEN10 105	V.Chitra	X	X	X	X	X	X	X	X	X	X	X	X	X	X	X	X



HOD

School of Education
Ponnaiyah Ramajayam Institute of
Science & Technology (PRIST)
THANJAVUR - 613 403.



DEAN

School of Education
Ponnaiyah Ramajayam Institute of
Science & Technology (PRIST)
THANJAVUR - 613 403.

32.	2302E DEN10 106	G.Nandhini	X	X	X	X	X	X	X	X	X	X	X	X	X	X	X	X
33.	2302E DEN10 107	J.Revathi	X	X	X	X	X	X	X	X	X	X	X	X	X	X	X	X
34.	2302E DEN10 108	J.Sangeetha	X	X	X	X	X	X	X	X	X	X	X	X	X	X	X	X
35.	2302E DEN10 109	T.Sasireka	X	X	X	X	X	X	X	X	X	X	X	X	X	X	X	X
36.	2302E DEN10 110	G.Lakshmi	X	X	X	X	X	X	X	X	X	X	X	X	X	X	X	X
37.	2302E DEN10 111	T.Sutha	X	X	X	X	X	X	X	X	X	X	X	X	X	X	X	X
38.	2302E DEN10 112	T.Indira	X	X	X	X	X	X	X	X	X	X	X	X	X	X	X	X
39.	230ED MA102 02	M.Krishnaveni	X	X	X	X	X	X	X	X	X	X	X	X	X	X	X	X
40.	230ED MA102 03	G.Regavathi	X	X	X	X	X	X	X	X	X	X	X	X	X	X	X	X
41.	230ED MA102 04	H. Jahabar Nachiya	X	X	X	X	X	X	X	X	X	X	X	X	X	X	X	X
42.	230ED MA102 05	V. Kiruba	X	X	X	X	X	X	X	X	X	X	X	X	X	X	X	X
43.	230ED MA102 06	K.Ambika	X	X	X	X	X	X	X	X	X	X	X	X	X	X	X	X
44.	230ED MA102 07	L.Angelomary	X	X	X	X	X	X	X	X	X	X	X	X	X	X	X	X
45.	230ED MA102 02	G.Saranya	X	X	X	X	X	X	X	X	X	X	X	X	X	X	X	X
46.	230ED MA102 03	R.Amuthakumari	X	X	X	X	X	X	X	X	X	X	X	X	X	X	X	X
47.	2302E DBS10 204	R.Kalaivani	X	X	X	X	X	X	X	X	X	X	X	X	X	X	X	X
48.	2302E DBS10 205	P.Kanmani	X	X	X	X	X	X	X	X	X	X	X	X	X	X	X	X

HOD

School of Education
Ponnaiyah Ramajayam Institute of
Science & Technology (PRIST)
THANJAVUR - 613 403.

DEAN

School of Education
Ponnaiyah Ramajayam Institute of
Science & Technology (PRIST)
THANJAVUR - 613 403

49.	2302E DBS10 206	T.Meena	X	X	X	X	X	X	X	X	X	X	X	X	X	X	X	X
50.	2302E DBS10 207	K.Sathiyapriya	X	X	X	X	X	X	X	X	X	X	X	X	X	X	X	X
51.	2302M ED202 01	Jeipreethi kanggeyavelu.K	X	X	X	X	X	X	X	X	X	X	X	X	X	X	X	X
52.	2302M ED202 02	Noor nisha.A	X	X	X	X	X	X	X	X	X	X	X	X	X	X	X	X
53.	2302M ED202 03	Nivethitha.R	X	X	X	X	X	X	X	X	X	X	X	X	X	X	X	X
54.	2302M ED202 04	Mahalakshmi.R	X	X	X	X	X	X	X	X	X	X	X	X	X	X	X	X
55.	2302M ED202 05	Preethi.N	X	X	X	X	X	X	X	X	X	X	X	X	X	X	X	X
56.	2302M ED202 06	AbiramiR	X	X	X	X	X	X	X	X	X	X	X	X	X	X	X	X
57.	2302M ED202 07	P. Ganesan	X	X	X	X	X	X	X	X	X	X	X	X	X	X	X	X
58.	2302M ED202 08	V. JayaKumar	X	X	X	X	X	X	X	X	X	X	X	X	X	X	X	X
59.	2302M ED202 09	L. Mekala	X	X	X	X	X	X	X	X	X	X	X	X	X	X	X	X
60.	2302M ED202 10	S. Annapoorni	X	X	X	X	X	X	X	X	X	X	X	X	X	X	X	X
61.	2302M ED202 11	R. Bommi	X	X	X	X	X	X	X	X	X	X	X	X	X	X	X	X
62.	2302M ED202 12	J. Elavarasi	X	X	X	X	X	X	X	X	X	X	X	X	X	X	X	X
63.	2302M ED202 13	P. Ezhilarasi	X	X	X	X	X	X	X	X	X	X	X	X	X	X	X	X
64.	2302M ED202 14	K. Joice Mary	X	X	X	X	X	X	X	X	X	X	X	X	X	X	X	X

HOD

School of Education
Ponnaiyah Ramajayam Institute of
Science & Technology (PRIST)
THANJAVUR - 613 403.

DEAN

School of Education
Ponnaiyah Ramajayam Institute of
Science & Technology
THANJAVUR - 613 403

65.	2302M ED202 15	P. Krishnapriya	X	X	X	X	X	X	X	X	X	X	X	X	X	X	X
66.	2302M ED202 16	T.Kumari	X	X	X	X	X	X	X	X	X	X	X	X	X	X	X
67.	2302M ED202 17	S.Manimekalai	X	X	X	X	X	X	X	X	X	X	X	X	X	X	X
68.	2302M ED202 18	M.Jeyarani	X	X	X	X	X	X	X	X	X	X	X	X	X	X	X
69.	2302M ED202 19	P.Selvarani	X	X	X	X	X	X	X	X	X	X	X	X	X	X	X
70.	2302M ED202 20	M.Suseela	X	X	X	X	X	X	X	X	X	X	X	X	X	X	X
71.	2302M ED202 21	A.Sirajinnisha	X	X	X	X	X	X	X	X	X	X	X	X	X	X	X
72.	2302M ED202 22	T.Sollararasan	X	X	X	X	X	X	X	X	X	X	X	X	X	X	X
73.	2302M ED202 23	S.Kavitha	X	X	X	X	X	X	X	X	X	X	X	X	X	X	X
74.	2302M ED202 24	T.Sumathi	X	X	X	X	X	X	X	X	X	X	X	X	X	X	X
75.	2302M ED202 25	A.T.Banu	X	X	X	X	X	X	X	X	X	X	X	X	X	X	X
Staff signature			<i>[Signature]</i>	<i>[Signature]</i>	<i>[Signature]</i>	<i>[Signature]</i>	<i>[Signature]</i>	<i>[Signature]</i>	<i>[Signature]</i>	<i>[Signature]</i>	<i>[Signature]</i>	<i>[Signature]</i>	<i>[Signature]</i>	<i>[Signature]</i>	<i>[Signature]</i>	<i>[Signature]</i>	<i>[Signature]</i>

HOD
 School of Education
 Ponnaiyah Ramajayam Institute of
 Science & Technology (PRIST)
 THANJAVUR - 613 403.

DEAN
 School of Education
 Ponnaiyah Ramajayam Institute of
 Science & Technology (PRIST)
 THANJAVUR - 613 403.



PONNAIYAH RAMAJAYAM INSTITUTE OF
SCIENCE & TECHNOLOGY (PRIST)

Declared as DEEMED-TO-BE UNIVERSITY
U/s 3 of UGC Act, 1956

SCHOOL OF EDUCATION

Value Added Course

COURSE TITLE: BASICS OF LAPTOP MAINTENANCE AND OS INSTALLATION

Students Attendance Date: (February - 2024)

Academic Year 2023 - 2024

S.No	Reg.No	Name	01	02	05	06	07	08	09	12	13	14	15	20	23	24	27
1.	2302E DTA10 201	MATHAVLR	X	X	X	X	X	X	X	X	X	X	X	X	X	X	X
2.	2302E DEN10 101	SUKENDRAN.R	X	X	X	X	X	X	X	X	X	X	X	X	X	X	X
3.	230ED MA102 01	KOWSALYA.M	X	X	X	X	X	X	X	X	X	X	X	X	X	X	X
4.	2301E DMA1 0202	KARTHIKAK	X	X	X	X	X	X	X	X	X	X	X	X	X	X	X
5.	2302E DMA1 0203	UMA.K	X	X	X	X	X	X	X	X	X	X	X	X	X	X	X
6.	2302E DMA1 0204	YAMUNA.M	X	X	X	X	X	X	X	X	X	X	X	X	X	X	X
7.	2302E DPC10 201	SIMRAN.E	X	X	X	X	X	X	X	X	X	X	X	X	X	X	X
8.	2302E DPC10 202	BABY SHALIN.L	X	X	X	X	X	X	X	X	X	X	X	X	X	X	X
9.	2302E DPC10 203	HEMA.G	X	X	X	X	X	X	X	X	X	X	X	X	X	X	X
10.	2302E DPC10 204	GOWSALYA.G	X	X	X	X	X	X	X	X	X	X	X	X	X	X	X
11.	2302E DPC10 205	ANUSUYA.D	X	X	X	X	X	X	X	X	X	X	X	X	X	X	X
12.	2302E DPC10 101	AMALRAJ. B	X	X	X	X	X	X	X	X	X	X	X	X	X	X	X
13.	2302E DBS10 201	PARIMALA.S	X	X	X	X	X	X	X	X	X	X	X	X	X	X	X
14.	2302E DBS10 202	PRIYADHARSH INLP	X	X	X	X	X	X	X	X	X	X	X	X	X	X	X

HOD

School of Education
Ponnaiyah Ramajayam Institute of
Science & Technology (PRIST)
THANJAVUR - 613 403

DEAN

School of Education
Ponnaiyah Ramajayam Institute of
Science & Technology (PRIST)
THANJAVUR - 613 403

15.	2301E DCS10 201	PRADEEPA.R	X	X	X	X	X	X	X	X	X	X	X	X	X	X	X
16.	2301E DCS10 101	KARTHIK. M	X	X	X	X	X	X	X	X	X	X	X	X	X	X	X
17.	2302E DCO10 201	VEENA.P	X	X	X	X	X	X	X	X	X	X	X	X	X	X	X
18.	2302E DHI10 201	JAYANTHI.D	X	X	X	X	X	X	X	X	X	X	X	X	X	X	X
19.	2302E DGO10 201	ABIRAMASUN DHARIS	X	X	X	X	X	X	X	X	X	X	X	X	X	X	X
20.	2302E DTA10 202	C.Amaravathi	X	X	X	X	X	X	X	X	X	X	X	X	X	X	X
21.	2302E DTA10 203	S.Anandhi	X	X	X	X	X	X	X	X	X	X	X	X	X	X	X
22.	2302E DTA10 204	N.Buvaneswari	X	X	X	X	X	X	X	X	X	X	X	X	X	X	X
23.	2302E DTA10 205	S.Juliet	X	X	X	X	X	X	X	X	X	X	X	X	X	X	X
24.	2302E DTA10 206	S.Jenifar	X	X	X	X	X	X	X	X	X	X	X	X	X	X	X
25.	2302E DTA10 207	X.Arockiya Mary	X	X	X	X	X	X	X	X	X	X	X	X	X	X	X
26.	2302E DTA10 208	R.Darathy	X	X	X	X	X	X	X	X	X	X	X	X	X	X	X
27.	2302E DTA10 209	B.Muthulakshmi	X	X	X	X	X	X	X	X	X	X	X	X	X	X	X
28.	2302E DEN10 102	S.Sumitra	X	X	X	X	X	X	X	X	X	X	X	X	X	X	X
29.	2302E DEN10 103	D.Vasumathi	X	X	X	X	X	X	X	X	X	X	X	X	X	X	X
30.	2302E DEN10 104	S.Divya	X	X	X	X	X	X	X	X	X	X	X	X	X	X	X
31.	2302E DEN10 105	V.Chitra	X	X	X	X	X	X	X	X	X	X	X	X	X	X	X

HOD

School of Education
Ponnaiyah Ramajayam Institute of
Science & Technology (PRIST)
THANJAVUR - 613 403.

DEAN

School of Education
Ponnaiyah Ramajayam Institute of
Science & Technology (PRIST)
THANJAVUR - 613 403.

32.	2302E DEN10 106	G.Nandhini	X	X	X	X	X	X	X	X	X	X	X	X	X	X	X
33.	2302E DEN10 107	J.Revathi	X	X	X	X	X	X	X	X	X	X	X	X	X	X	X
34.	2302E DEN10 108	J.Sangeetha	X	X	X	X	X	X	X	X	X	X	X	X	X	X	X
35.	2302E DEN10 109	T.Sasireka	X	X	X	X	X	X	X	X	X	X	X	X	X	X	X
36.	2302E DEN10 110	G.Lakshmi	X	X	X	X	X	X	X	X	X	X	X	X	X	X	X
37.	2302E DEN10 111	T.Sutha	X	X	X	X	X	X	X	X	X	X	X	X	X	X	X
38.	2302E DEN10 112	T.Indira	X	X	X	X	X	X	X	X	X	X	X	X	X	X	X
39.	230ED MA102 02	M.Krishnaveni	X	X	X	X	X	X	X	X	X	X	X	X	X	X	X
40.	230ED MA102 03	G.Regavathi	X	X	X	X	X	X	X	X	X	X	X	X	X	X	X
41.	230ED MA102 04	H. Jahabar Nachiya	X	X	X	X	X	X	X	X	X	X	X	X	X	X	X
42.	230ED MA102 05	V. Kiruba	X	X	X	X	X	X	X	X	X	X	X	X	X	X	X
43.	230ED MA102 06	K.Ambika	X	X	X	X	X	X	X	X	X	X	X	X	X	X	X
44.	230ED MA102 07	L.Angelomary	X	X	X	X	X	X	X	X	X	X	X	X	X	X	X
45.	230ED MA102 02	G.Saranya	X	X	X	X	X	X	X	X	X	X	X	X	X	X	X
46.	230ED MA102 03	R.Amuthakumari	X	X	X	X	X	X	X	X	X	X	X	X	X	X	X
47.	2302E DBS10 204	R.Kalaivani	X	X	X	X	X	X	X	X	X	X	X	X	X	X	X
48.	2302E DBS10 205	P.Kanmani	X	X	X	X	X	X	X	X	X	X	X	X	X	X	X

HOD

School of Education
Ponniyalai Ramajayam Institute of
Science & Technology (PRIST)
THANJAVUR - 613 403.

DEAN

School of Education
Ponniyalai Ramajayam Institute of
Science & Technology (PRIST)
THANJAVUR - 613 403.

49.	2302E DBS10 206	T.Meena	X	X	X	X	X	X	X	X	X	X	X	X	X	X	X
50.	2302E DBS10 207	K.Sathiyapriya	X	X	X	X	X	X	X	X	X	X	X	X	X	X	X
51.	2302M ED202 01	Jeipreethi kanggeyavelu.K	X	X	X	X	X	X	X	X	X	X	X	X	X	X	X
52.	2302M ED202 02	Noor nisha.A	X	X	X	X	X	X	X	X	X	X	X	X	X	X	X
53.	2302M ED202 03	Nivethitha.R	X	X	X	X	X	X	X	X	X	X	X	X	X	X	X
54.	2302M ED202 04	Mahalakshmi.R	X	X	X	X	X	X	X	X	X	X	X	X	X	X	X
55.	2302M ED202 05	Preethi.N	X	X	X	X	X	X	X	X	X	X	X	X	X	X	X
56.	2302M ED202 06	AbiramiR	X	X	X	X	X	X	X	X	X	X	X	X	X	X	X
57.	2302M ED202 07	P. Ganesan	X	X	X	X	X	X	X	X	X	X	X	X	X	X	X
58.	2302M ED202 08	V. JayaKumar	X	X	X	X	X	X	X	X	X	X	X	X	X	X	X
59.	2302M ED202 09	L. Mekala	X	X	X	X	X	X	X	X	X	X	X	X	X	X	X
60.	2302M ED202 10	S. Annapoorni	X	X	X	X	X	X	X	X	X	X	X	X	X	X	X
61.	2302M ED202 11	R. Bommi	X	X	X	X	X	X	X	X	X	X	X	X	X	X	X
62.	2302M ED202 12	J. Elavarasi	X	X	X	X	X	X	X	X	X	X	X	X	X	X	X
63.	2302M ED202 13	P. Ezhilarasi	X	X	X	X	X	X	X	X	X	X	X	X	X	X	X
64.	2302M ED202 14	K. Joice Mary	X	X	X	X	X	X	X	X	X	X	X	X	X	X	X

HOD

School of Education
Ponniyah Ramajayam Institute of
Science & Technology (PRIST)
THANJAVUR - 613 403.

DEAN

School of Education
Ponniyah Ramajayam Institute of
Science & Technology (PRIST)
THANJAVUR - Page 929 of 1367

65.	2302M ED202 15	P. Krishnapriya	X	X	X	X	X	X	X	X	X	X	X	X	X	X	X
66.	2302M ED202 16	T.Kumari	X	X	X	X	X	X	X	X	X	X	X	X	X	X	X
67.	2302M ED202 17	S.Manimekalai	X	X	X	X	X	X	X	X	X	X	X	X	X	X	X
68.	2302M ED202 18	M.Jeyarani	X	X	X	X	X	X	X	X	X	X	X	X	X	X	X
69.	2302M ED202 19	P.Selvarani	X	X	X	X	X	X	X	X	X	X	X	X	X	X	X
70.	2302M ED202 20	M.Suseela	X	X	X	X	X	X	X	X	X	X	X	X	X	X	X
71.	2302M ED202 21	A.Sirajinnisha	X	X	X	X	X	X	X	X	X	X	X	X	X	X	X
72.	2302M ED202 22	T.Sollararasan	X	X	X	X	X	X	X	X	X	X	X	X	X	X	X
73.	2302M ED202 23	S.Kavitha	X	X	X	X	X	X	X	X	X	X	X	X	X	X	X
74.	2302M ED202 24	T.Sumathi	X	X	X	X	X	X	X	X	X	X	X	X	X	X	X
75.	2302M ED202 25	A.T.Banu	X	X	X	X	X	X	X	X	X	X	X	X	X	X	X
Staff signature																	

HOD
School of Education
Ponnaiyah Ramajayam Institute of
Science & Technology (PRIST)
THANJAVUR - 613 403.

DEAN
School of Education
Ponnaiyah Ramajayam Institute of
Science & Technology (PRIST)
THANJAVUR - 613 403.



**PONNAIYAH RAMAJAYAM INSTITUTE OF
SCIENCE & TECHNOLOGY (PRIST)**

Declared as DEEMED-TO-BE-UNIVERSITY
U/s 3 of UGC Act, 1956

SCHOOL OF EDUCATION

Value Added Course

COURSE TITLE: BASICS OF LAPTOP MAINTENANCE AND OS INSTALLATION

Students Attendance Date: (March - 2024)

Academic Year 2023 – 2024

S.No	Reg.No	Name	01	02	04	06	09	11	13	14	16	18	19	20	23	26	27
1.	2302E DTA10 201	MATHAVI.R	X	X	X	X	X	X	X	X	X	X	X	X	X	X	X
2.	2302E DEN10 101	SUKENDRAN.R	X	X	X	X	X	X	X	X	X	X	X	X	X	X	X
3.	2302E MA102 01	KOWSALYA.M	X	X	X	X	X	X	X	X	X	X	X	X	X	X	X
4.	2301E DMA1 0202	KARTHIKA.K	X	X	X	X	X	X	X	X	X	X	X	X	X	X	X
5.	2302E DMA1 0203	UMA.K	X	X	X	X	X	X	X	X	X	X	X	X	X	X	X
6.	2302E DMA1 0204	YAMUNA.M	X	X	X	X	X	X	X	X	X	X	X	X	X	X	X
7.	2302E DPC10 201	SIMRAN.E	X	X	X	X	X	X	X	X	X	X	X	X	X	X	X
8.	2302E DPC10 202	BABY SHALINI.L	X	X	X	X	X	X	X	X	X	X	X	X	X	X	X
9.	2302E DPC10 203	HEMA.G	X	X	X	X	X	X	X	X	X	X	X	X	X	X	X
10.	2302E DPC10 204	GOWSALYA.G	X	X	X	X	X	X	X	X	X	X	X	X	X	X	X
11.	2302E DPC10 205	ANUSUYA.D	X	X	X	X	X	X	X	X	X	X	X	X	X	X	X
12.	2302E DPC10 101	AMALRAJ.B	X	X	X	X	X	X	X	X	X	X	X	X	X	X	X
13.	2302E DBS10 201	PARIMALA.S	X	X	X	X	X	X	X	X	X	X	X	X	X	X	X
14.	2302E DBS10 202	PRIYADHARSH INLP	X	X	X	X	X	X	X	X	X	X	X	X	X	X	X

HOD

School of Education
Ponnaiyah Ramajayam Institute of
Science & Technology (PRIST)
THANJAVUR - 613 403.

DEAN

School of Education
Ponnaiyah Ramajayam Institute of
Science & Technology (PRIST)
THANJAVUR - 613 403.

15.	2301E DCS10 201	PRADEEPA.R	X	X	X	X	X	X	X	X	X	X	X	X	X	X	X	X
16.	2301E DCS10 101	KARTHIK. M	X	X	X	X	X	X	X	X	X	X	X	X	X	X	X	X
17.	2302E DCO10 201	VEENA.P	X	X	X	X	X	X	X	X	X	X	X	X	X	X	X	X
18.	2302E DHI10 201	JAYANTHI.D	X	X	X	X	X	X	X	X	X	X	X	X	X	X	X	X
19.	2302E DGO10 201	ABIRAMASUN DHARLS	X	X	X	X	X	X	X	X	X	X	X	X	X	X	X	X
20.	2302E DTA10 202	C.Amaravathi	X	X	X	X	X	X	X	X	X	X	X	X	X	X	X	X
21.	2302E DTA10 203	S.Anandhi	X	X	X	X	X	X	X	X	X	X	X	X	X	X	X	X
22.	2302E DTA10 204	N.Buveneswari	X	X	X	X	X	X	X	X	X	X	X	X	X	X	X	X
23.	2302E DTA10 205	S.Juliet	X	X	X	X	X	X	X	X	X	X	X	X	X	X	X	X
24.	2302E DTA10 206	S.Jenifar	X	X	X	X	X	X	X	X	X	X	X	X	X	X	X	X
25.	2302E DTA10 207	X.Arockiya Mary	X	X	X	X	X	X	X	X	X	X	X	X	X	X	X	X
26.	2302E DTA10 208	R.Darathy	X	X	X	X	X	X	X	X	X	X	X	X	X	X	X	X
27.	2302E DTA10 209	B.Muthulakshmi	X	X	X	X	X	X	X	X	X	X	X	X	X	X	X	X
28.	2302E DEN10 102	S.Sumitra	X	X	X	X	X	X	X	X	X	X	X	X	X	X	X	X
29.	2302E DEN10 103	D.Vasumathi	X	X	X	X	X	X	X	X	X	X	X	X	X	X	X	X
30.	2302E DEN10 104	S.Divya	X	X	X	X	X	X	X	X	X	X	X	X	X	X	X	X
31.	2302E DEN10 105	V.Chitra	X	X	X	X	X	X	X	X	X	X	X	X	X	X	X	X

HOD

School of Education
Ponnaiyah Ramajayam Institute of
Science & Technology (PRIEST),
THANJAVUR - 613.403.-

DEAN

School of Education
Ponnaiyah Ramajayam Institute of
Science & Technology (PRIEST),
THANJAVUR - 613.403.-

32.	2302E DEN10 106	G.Nandhini	X	X	X	X	X	X	X	X	X	X	X	X	X	X	X
33.	2302E DEN10 107	J.Revathi	X	X	X	X	X	X	X	X	X	X	X	X	X	X	X
34.	2302E DEN10 108	J.Sangeetha	X	X	X	X	X	X	X	X	X	X	X	X	X	X	X
35.	2302E DEN10 109	T.Sasireka	X	X	X	X	X	X	X	X	X	X	X	X	X	X	X
36.	2302E DEN10 110	G.Lakshmi	X	X	X	X	X	X	X	X	X	X	X	X	X	X	X
37.	2302E DEN10 111	T.Sutha	X	X	X	X	X	X	X	X	X	X	X	X	X	X	X
38.	2302E DEN10 112	T.Indira	X	X	X	X	X	X	X	X	X	X	X	X	X	X	X
39.	230ED MA102 02	M.Krishnaveni	X	X	X	X	X	X	X	X	X	X	X	X	X	X	X
40.	230ED MA102 03	G.Regavathi	X	X	X	X	X	X	X	X	X	X	X	X	X	X	X
41.	230ED MA102 04	H. Jahabar Nachiya	X	X	X	X	X	X	X	X	X	X	X	X	X	X	X
42.	230ED MA102 05	V. Kiruba	X	X	X	X	X	X	X	X	X	X	X	X	X	X	X
43.	230ED MA102 06	K.Ambika	X	X	X	X	X	X	X	X	X	X	X	X	X	X	X
44.	230ED MA102 07	L.Angelomary	X	X	X	X	X	X	X	X	X	X	X	X	X	X	X
45.	230ED MA102 02	G.Saranya	X	X	X	X	X	X	X	X	X	X	X	X	X	X	X
46.	230ED MA102 03	R.Amuthakumari	X	X	X	X	X	X	X	X	X	X	X	X	X	X	X
47.	2302E DBS10 204	R.Kalaivani	X	X	X	X	X	X	X	X	X	X	X	X	X	X	X
48.	2302E DBS10 205	P.Kanmani	X	X	X	X	X	X	X	X	X	X	X	X	X	X	X

HOD

School of Education
Ponnaiyah Ramajayam Institute of
Science & Technology (PRIST)
THANJAVUR - 613 403

DEAN

School of Education
Ponnaiyah Ramajayam Institute of
Science & Technology (PRIST)
THANJAVUR - 613 403

49.	2302E DBS10 206	T.Meena	X	X	X	X	X	X	X	X	X	X	X	X	X	X	X
50.	2302E DBS10 207	K.Sathiyapriya	X	X	X	X	X	X	X	X	X	X	X	X	X	X	X
51.	2302M ED202 01	Jeipreethi kanggeyavelu.K	X	X	X	X	X	X	X	X	X	X	X	X	X	X	X
52.	2302M ED202 02	Noor nisha.A	X	X	X	X	X	X	X	X	X	X	X	X	X	X	X
53.	2302M ED202 03	Nivethitha.R	X	X	X	X	X	X	X	X	X	X	X	X	X	X	X
54.	2302M ED202 04	Mahalakshmi.R	X	X	X	X	X	X	X	X	X	X	X	X	X	X	X
55.	2302M ED202 05	Preethi.N	X	X	X	X	X	X	X	X	X	X	X	X	X	X	X
56.	2302M ED202 06	AbiramiR	X	X	X	X	X	X	X	X	X	X	X	X	X	X	X
57.	2302M ED202 07	P. Ganesan	X	X	X	X	X	X	X	X	X	X	X	X	X	X	X
58.	2302M ED202 08	V. JayaKumar	X	X	X	X	X	X	X	X	X	X	X	X	X	X	X
59.	2302M ED202 09	L. Mekala	X	X	X	X	X	X	X	X	X	X	X	X	X	X	X
60.	2302M ED202 10	S. Annapoorni	X	X	X	X	X	X	X	X	X	X	X	X	X	X	X
61.	2302M ED202 11	R. Bommi	X	X	X	X	X	X	X	X	X	X	X	X	X	X	X
62.	2302M ED202 12	J. Elavarasi	X	X	X	X	X	X	X	X	X	X	X	X	X	X	X
63.	2302M ED202 13	P. Ezhilarasi	X	X	X	X	X	X	X	X	X	X	X	X	X	X	X
64.	2302M ED202 14	K. Joice Mary	X	X	X	X	X	X	X	X	X	X	X	X	X	X	X

HOD

School of Education
Ponnaiyah Ramajayam Institute of
Science & Technology (PRIST)
THANJAVUR - 613 403.

DEAN

School of Education
Ponnaiyah Ramajayam Institute of
Science & Technology (PRIST)
THANJAVUR - 613 403

65.	2302M ED202 15	P. Krishnapriya	X	X	X	X	X	X	X	X	X	X	X	X	X	X	X
66.	2302M ED202 16	T.Kumari	X	X	X	X	X	X	X	X	X	X	X	X	X	X	X
67.	2302M ED202 17	S.Manimekalai	X	X	X	X	X	X	X	X	X	X	X	X	X	X	X
68.	2302M ED202 18	M.Jeyarani	X	X	X	X	X	X	X	X	X	X	X	X	X	X	X
69.	2302M ED202 19	P.Selvarani	X	X	X	X	X	X	X	X	X	X	X	X	X	X	X
70.	2302M ED202 20	M.Suseela	X	X	X	X	X	X	X	X	X	X	X	X	X	X	X
71.	2302M ED202 21	A.Sirajinnisha	X	X	X	X	X	X	X	X	X	X	X	X	X	X	X
72.	2302M ED202 22	T.Sollararasan	X	X	X	X	X	X	X	X	X	X	X	X	X	X	X
73.	2302M ED202 23	S.Kavitha	X	X	X	X	X	X	X	X	X	X	X	X	X	X	X
74.	2302M ED202 24	T.Sumathi	X	X	X	X	X	X	X	X	X	X	X	X	X	X	X
75.	2302M ED202 25	A.T.Banu	X	X	X	X	X	X	X	X	X	X	X	X	X	X	X
Staff signature			<i>[Signature]</i>	<i>[Signature]</i>	<i>[Signature]</i>	<i>[Signature]</i>	<i>[Signature]</i>	<i>[Signature]</i>	<i>[Signature]</i>	<i>[Signature]</i>	<i>[Signature]</i>	<i>[Signature]</i>	<i>[Signature]</i>	<i>[Signature]</i>	<i>[Signature]</i>	<i>[Signature]</i>	<i>[Signature]</i>

HOD
 School of Education
 Ponnaiyah Ramajayam Institute of
 Science & Technology (PRIST)
 THANJAVUR - 613 403.

DEAN
 School of Education
 Ponnaiyah Ramajayam Institute of
 Science & Technology (PRIST)
 THANJAVUR - 613 403.



SCHOOL OF EDUCATION

Value Added Course

COURSE TITLE: BASICS OF LAPTOP MAINTENANCE AND OS INSTALLATION

Students Attendance Date: (April - 2024)

Academic Year 2023 – 2024

S.No	Reg.No	Name	02	03	04	06	08	10	13	15	16	18	19	20	23	24	27
1.	2302E DTA10 201	MATHAVLR	X	X	X	X	X	X	X	X	X	X	X	X	X	X	X
2.	2302E DEN10 101	SUKENDRAN.R	X	X	X	X	X	X	X	X	X	X	X	X	X	X	X
3.	230ED MA102 01	KOWSALYA.M	X	X	X	X	X	X	X	X	X	X	X	X	X	X	X
4.	2301E DMA1 0202	KARTHIKA.K	X	X	X	X	X	X	X	X	X	X	X	X	X	X	X
5.	2302E DMA1 0203	UMA.K	X	X	X	X	X	X	X	X	X	X	X	X	X	X	X
6.	2302E DMA1 0204	YAMUNA.M	X	X	X	X	X	X	X	X	X	X	X	X	X	X	X
7.	2302E DPC10 201	SIMRAN.E	X	X	X	X	X	X	X	X	X	X	X	X	X	X	X
8.	2302E DPC10 202	BABY SHALINLL	X	X	X	X	X	X	X	X	X	X	X	X	X	X	X
9.	2302E DPC10 203	HEMA.G	X	X	X	X	X	X	X	X	X	X	X	X	X	X	X
10.	2302E DPC10 204	GOWSALYA.G	X	X	X	X	X	X	X	X	X	X	X	X	X	X	X
11.	2302E DPC10 205	ANUSUYA.D	X	X	X	X	X	X	X	X	X	X	X	X	X	X	X
12.	2302E DPC10 101	AMALRAJ.B	X	X	X	X	X	X	X	X	X	X	X	X	X	X	X
13.	2302E DBS10 201	PARIMALA.S	X	X	X	X	X	X	X	X	X	X	X	X	X	X	X
14.	2302E DBS10 202	PRIYADHARSH INLP	X	X	X	X	X	X	X	X	X	X	X	X	X	X	X

HOD

School of Education
Ponnaiyah Ramajayam Institute of
Science & Technology (PRIST)
THANJAVUR - 613 004

DEAN

School of Education
Ponnaiyah Ramajayam Institute of
Science & Technology (PRIST)
THANJAVUR - 613 004

15.	2301E DCS10 201	PRADEEPA.R	X	X	X	X	X	X	X	X	X	X	X	X	X	X	X
16.	2301E DCS10 101	KARTHIK. M	X	X	X	X	X	X	X	X	X	X	X	X	X	X	X
17.	2302E DCO10 201	VEENA.P	X	X	X	X	X	X	X	X	X	X	X	X	X	X	X
18.	2302E DHI10 201	JAYANTHLD	X	X	X	X	X	X	X	X	X	X	X	X	X	X	X
19.	2302E DGO10 201	ABIRAMASUN DHARLS	X	X	X	X	X	X	X	X	X	X	X	X	X	X	X
20.	2302E DTA10 202	C.Amaravathi	X	X	X	X	X	X	X	X	X	X	X	X	X	X	X
21.	2302E DTA10 203	S.Anandhi	X	X	X	X	X	X	X	X	X	X	X	X	X	X	X
22.	2302E DTA10 204	N.Buvaneswari	X	X	X	X	X	X	X	X	X	X	X	X	X	X	X
23.	2302E DTA10 205	S.Juliet	X	X	X	X	X	X	X	X	X	X	X	X	X	X	X
24.	2302E DTA10 206	S.Jenifar	X	X	X	X	X	X	X	X	X	X	X	X	X	X	X
25.	2302E DTA10 207	X.Arockiya Mary	X	X	X	X	X	X	X	X	X	X	X	X	X	X	X
26.	2302E DTA10 208	R.Darathy	X	X	X	X	X	X	X	X	X	X	X	X	X	X	X
27.	2302E DTA10 209	B.Muthulakshmi	X	X	X	X	X	X	X	X	X	X	X	X	X	X	X
28.	2302E DEN10 102	S.Sumitra	X	X	X	X	X	X	X	X	X	X	X	X	X	X	X
29.	2302E DEN10 103	D.Vasumathi	X	X	X	X	X	X	X	X	X	X	X	X	X	X	X
30.	2302E DEN10 104	S.Divya	X	X	X	X	X	X	X	X	X	X	X	X	X	X	X
31.	2302E DEN10 105	V.Chitra	X	X	X	X	X	X	X	X	X	X	X	X	X	X	X

HOD

School of Education
Ponnaiyah Ramajoyam Institute of
Science & Technology (PRIST)
THANJAVUR - 613 403

DEAN

School of Education
Ponnaiyah Ramajoyam Institute of
Science & Technology (PRIST)
THANJAVUR - 613 403

32.	2302E DEN10 106	G.Nandhini	X	X	X	X	X	X	X	X	X	X	X	X	X	X	X	X
33.	2302E DEN10 107	J.Revathi	X	X	X	X	X	X	X	X	X	X	X	X	X	X	X	X
34.	2302E DEN10 108	J.Sangeetha	X	X	X	X	X	X	X	X	X	X	X	X	X	X	X	X
35.	2302E DEN10 109	T.Sasireka	X	X	X	X	X	X	X	X	X	X	X	X	X	X	X	X
36.	2302E DEN10 110	G.Lakshmi	X	X	X	X	X	X	X	X	X	X	X	X	X	X	X	X
37.	2302E DEN10 111	T.Sutha	X	X	X	X	X	X	X	X	X	X	X	X	X	X	X	X
38.	2302E DEN10 112	T.Indira	X	X	X	X	X	X	X	X	X	X	X	X	X	X	X	X
39.	230ED MA102 02	M.Krishnaveni	X	X	X	X	X	X	X	X	X	X	X	X	X	X	X	X
40.	230ED MA102 03	G.Regavathi	X	X	X	X	X	X	X	X	X	X	X	X	X	X	X	X
41.	230ED MA102 04	H. Jahabar Nachiya	X	X	X	X	X	X	X	X	X	X	X	X	X	X	X	X
42.	230ED MA102 05	V. Kiruba	X	X	X	X	X	X	X	X	X	X	X	X	X	X	X	X
43.	230ED MA102 06	K.Ambika	X	X	X	X	X	X	X	X	X	X	X	X	X	X	X	X
44.	230ED MA102 07	L.Angelomary	X	X	X	X	X	X	X	X	X	X	X	X	X	X	X	X
45.	230ED MA102 02	G.Saranya	X	X	X	X	X	X	X	X	X	X	X	X	X	X	X	X
46.	230ED MA102 03	R.Amuthakumari	X	X	X	X	X	X	X	X	X	X	X	X	X	X	X	X
47.	2302E DBS10 204	R.Kalaivani	X	X	X	X	X	X	X	X	X	X	X	X	X	X	X	X
48.	2302E DBS10 205	P.Kanmani	X	X	X	X	X	X	X	X	X	X	X	X	X	X	X	X

HOD

School of Education
Ponnaiyah Ramajayam Institute of
Science & Technology (PRIST)
THANJAVUR - 613 403.

DEAN

School of Education
Ponnaiyah Ramajayam Institute of
Science & Technology (PRIST)
THANJAVUR - 613 403

49.	2302E DBS10 206	T.Meena	X	X	X	X	X	X	X	X	X	X	X	X	X	X	X
50.	2302E DBS10 207	K.Sathiyapriya	X	X	X	X	X	X	X	X	X	X	X	X	X	X	X
51.	2302M ED202 01	Jeipreethi kanggeyavelu.K	X	X	X	X	X	X	X	X	X	X	X	X	X	X	X
52.	2302M ED202 02	Noor nisha.A	X	X	X	X	X	X	X	X	X	X	X	X	X	X	X
53.	2302M ED202 03	Nivethitha.R	X	X	X	X	X	X	X	X	X	X	X	X	X	X	X
54.	2302M ED202 04	Mahalakshmi.R	X	X	X	X	X	X	X	X	X	X	X	X	X	X	X
55.	2302M ED202 05	Preethi.N	X	X	X	X	X	X	X	X	X	X	X	X	X	X	X
56.	2302M ED202 06	AbiramiR	X	X	X	X	X	X	X	X	X	X	X	X	X	X	X
57.	2302M ED202 07	P. Ganesan	X	X	X	X	X	X	X	X	X	X	X	X	X	X	X
58.	2302M ED202 08	V. JayaKumar	X	X	X	X	X	X	X	X	X	X	X	X	X	X	X
59.	2302M ED202 09	L. Mekala	X	X	X	X	X	X	X	X	X	X	X	X	X	X	X
60.	2302M ED202 10	S. Annapoorni	X	X	X	X	X	X	X	X	X	X	X	X	X	X	X
61.	2302M ED202 11	R. Bommi	X	X	X	X	X	X	X	X	X	X	X	X	X	X	X
62.	2302M ED202 12	J. Elavarasi	X	X	X	X	X	X	X	X	X	X	X	X	X	X	X
63.	2302M ED202 13	P. Ezhilarasi	X	X	X	X	X	X	X	X	X	X	X	X	X	X	X
64.	2302M ED202 14	K. Joice Mary	X	X	X	X	X	X	X	X	X	X	X	X	X	X	X













ch

HOD

School of Education
Ponnaiyah Ramajayam Institute of
Science & Technology (PRIST)
THANJAVUR - 613 403.

ch
DEAN

School of Education
Ponnaiyah Ramajayam Institute of
Science & Technology (PRIST)
THANJAVUR - 613 403.

65.	2302M ED202 15	P. Krishnapriya	X	X	X	X	X	X	X	X	X	X	X	X	X	X	X
66.	2302M ED202 16	T.Kumari	X	X	X	X	X	X	X	X	X	X	X	X	X	X	X
67.	2302M ED202 17	S.Manimekalai	X	X	X	X	X	X	X	X	X	X	X	X	X	X	X
68.	2302M ED202 18	M.Jeyarani	X	X	X	X	X	X	X	X	X	X	X	X	X	X	X
69.	2302M ED202 19	P.Selvarani	X	X	X	X	X	X	X	X	X	X	X	X	X	X	X
70.	2302M ED202 20	M.Suseela	X	X	X	X	X	X	X	X	X	X	X	X	X	X	X
71.	2302M ED202 21	A.Sirajinnisha	X	X	X	X	X	X	X	X	X	X	X	X	X	X	X
72.	2302M ED202 22	T.Sollararasan	X	X	X	X	X	X	X	X	X	X	X	X	X	X	X
73.	2302M ED202 23	S.Kavitha	X	X	X	X	X	X	X	X	X	X	X	X	X	X	X
74.	2302M ED202 24	T.Sumathi	X	X	X	X	X	X	X	X	X	X	X	X	X	X	X
75.	2302M ED202 25	A.T.Banu	X	X	X	X	X	X	X	X	X	X	X	X	X	X	X
Staff signature																	

HOD
 School of Education
 Ponnaiyah Ramajayam Institute of
 Science & Technology (PRIST)
 THANJAVUR - 613 403.

DEAN
 School of Education
 Ponnaiyah Ramajayam Institute
 Science & Technology (PRIST)
 THANJAVUR - 613 403.



SCHOOL OF EDUCATION
Value Added Course
COURSE TITLE: TIME MANAGEMENT
Students Attendance Date: (February - 2024)
Academic Year 2023 – 2024

S.No	Reg.No	Name	01	02	05	06	07	08	09	12	13	14	15	20	23	24	27
1.	2302E DTA10 201	MATHAVI.R	X	X	X	X	X	X	X	X	X	X	X	X	X	X	X
2.	2302E DEN10 101	SUKENDRAN.R	X	X	X	X	X	X	X	X	X	X	X	X	X	X	X
3.	230ED MA102 01	KOWSALYA.M	X	X	X	X	X	X	X	X	X	X	X	X	X	X	X
4.	2301E DMA1 0202	KARTHIKA.K	X	X	X	X	X	X	X	X	X	X	X	X	X	X	X
5.	2302E DMA1 0203	UMA.K	X	X	X	X	X	X	X	X	X	X	X	X	X	X	X
6.	2302E DMA1 0204	YAMUNA.M	X	X	X	X	X	X	X	X	X	X	X	X	X	X	X
7.	2302E DPC10 201	SIMRAN.E	X	X	X	X	X	X	X	X	X	X	X	X	X	X	X
8.	2302E DPC10 202	BABY SHALINLL	X	X	X	X	X	X	X	X	X	X	X	X	X	X	X
9.	2302E DPC10 203	HEMA.G	X	X	X	X	X	X	X	X	X	X	X	X	X	X	X
10.	2302E DPC10 204	GOWSALYA.G	X	X	X	X	X	X	X	X	X	X	X	X	X	X	X
11.	2302E DPC10 205	ANUSUYA.D	X	X	X	X	X	X	X	X	X	X	X	X	X	X	X
12.	2302E DPC10 101	AMALRAJ. B	X	X	X	X	X	X	X	X	X	X	X	X	X	X	X
13.	2302E DBS10 201	PARIMALA.S	X	X	X	X	X	X	X	X	X	X	X	X	X	X	X
14.	2302E DBS10 202	PRIYADHARSH INLP	X	X	X	X	X	X	X	X	X	X	X	X	X	X	X

HOD

DEAN

15.	2301E DCS10 201	PRADEEPA.R	X	X	X	X	X	X	X	X	X	X	X	X	X	X	X
16.	2301E DCS10 101	KARTHIK. M	X	X	X	X	X	X	X	X	X	X	X	X	X	X	X
17.	2302E DCO10 201	VEENA.P	X	X	X	X	X	X	X	X	X	X	X	X	X	X	X
18.	2302E DHI10 201	JAYANTHLD	X	X	X	X	X	X	X	X	X	X	X	X	X	X	X
19.	2302E DGO10 201	ABIRAMASUN DHARLS	X	X	X	X	X	X	X	X	X	X	X	X	X	X	X
20.	2302E DTA10 202	C.Amaravathi	X	X	X	X	X	X	X	X	X	X	X	X	X	X	X
21.	2302E DTA10 203	S.Anandhi	X	X	X	X	X	X	X	X	X	X	X	X	X	X	X
22.	2302E DTA10 204	N.Buvaneswari	X	X	X	X	X	X	X	X	X	X	X	X	X	X	X
23.	2302E DTA10 205	S.Juliet	X	X	X	X	X	X	X	X	X	X	X	X	X	X	X
24.	2302E DTA10 206	S.Jenifar	X	X	X	X	X	X	X	X	X	X	X	X	X	X	X
25.	2302E DTA10 207	X.Arockiya Mary	X	X	X	X	X	X	X	X	X	X	X	X	X	X	X
26.	2302E DTA10 208	R.Darathy	X	X	X	X	X	X	X	X	X	X	X	X	X	X	X
27.	2302E DTA10 209	B.Muthulakshmi	X	X	X	X	X	X	X	X	X	X	X	X	X	X	X
28.	2302E DEN10 102	S.Sumitra	X	X	X	X	X	X	X	X	X	X	X	X	X	X	X
29.	2302E DEN10 103	D.Vasumathi	X	X	X	X	X	X	X	X	X	X	X	X	X	X	X
30.	2302E DEN10 104	S.Divya	X	X	X	X	X	X	X	X	X	X	X	X	X	X	X
31.	2302E DEN10 105	V.Chitra	X	X	X	X	X	X	X	X	X	X	X	X	X	X	X

HOD

School of Education
Ponnaiyah Ramajayam Institute of
Science & Technology (PRIST)
THANJAVUR - 613 403.

DEAN

School of Education
Ponnaiyah Ramajayam Institute of
Science & Technology (PRIST)
THANJAVUR - 613 403.

32.	2302E DEN10 106	G.Nandhini	X	X	X	X	X	X	X	X	X	X	X	X	X	X	X	X
33.	2302E DEN10 107	J.Revathi	X	X	X	X	X	X	X	X	X	X	X	X	X	X	X	X
34.	2302E DEN10 108	J.Sangeetha	X	X	X	X	X	X	X	X	X	X	X	X	X	X	X	X
35.	2302E DEN10 109	T.Sasireka	X	X	X	X	X	X	X	X	X	X	X	X	X	X	X	X
36.	2302E DEN10 110	G.Lakshmi	X	X	X	X	X	X	X	X	X	X	X	X	X	X	X	X
37.	2302E DEN10 111	T.Sutha	X	X	X	X	X	X	X	X	X	X	X	X	X	X	X	X
38.	2302E DEN10 112	T.Indira	X	X	X	X	X	X	X	X	X	X	X	X	X	X	X	X
39.	230ED MA102 02	M.Krishnaveni	X	X	X	X	X	X	X	X	X	X	X	X	X	X	X	X
40.	230ED MA102 03	G.Regavathi	X	X	X	X	X	X	X	X	X	X	X	X	X	X	X	X
41.	230ED MA102 04	H. Jahabar Nachiya	X	X	X	X	X	X	X	X	X	X	X	X	X	X	X	X
42.	230ED MA102 05	V. Kiruba	X	X	X	X	X	X	X	X	X	X	X	X	X	X	X	X
43.	230ED MA102 06	K.Ambika	X	X	X	X	X	X	X	X	X	X	X	X	X	X	X	X
44.	230ED MA102 07	L.Angelomary	X	X	X	X	X	X	X	X	X	X	X	X	X	X	X	X
45.	230ED MA102 02	G.Saranya	X	X	X	X	X	X	X	X	X	X	X	X	X	X	X	X
46.	230ED MA102 03	R.Amuthakumari	X	X	X	X	X	X	X	X	X	X	X	X	X	X	X	X
47.	2302E DBS10 204	R.Kalaivani	X	X	X	X	X	X	X	X	X	X	X	X	X	X	X	X
48.	2302E DBS10 205	P.Kanmani	X	X	X	X	X	X	X	X	X	X	X	X	X	X	X	X

HOD

School of Education
Ponnaiyah Ramajayam Institute of
Science & Technology (PRIST)
THANJAVUR - 613 403

DEAN

School of Education
Ponnaiyah Ramajayam Institute of
Science & Technology (PRIST)
THANJAVUR - 613 403

49.	2302E DBS10 206	T.Meena	X	X	X	X	X	X	X	X	X	X	X	X	X	X	X
50.	2302E DBS10 207	K.Sathiyapriya	X	X	X	X	X	X	X	X	X	X	X	X	X	X	X
51.	2302M ED202 01	Jeipreethi kanggeyavelu.K	X	X	X	X	X	X	X	X	X	X	X	X	X	X	X
52.	2302M ED202 02	Noor nisha.A	X	X	X	X	X	X	X	X	X	X	X	X	X	X	X
53.	2302M ED202 03	Nivethitha.R	X	X	X	X	X	X	X	X	X	X	X	X	X	X	X
54.	2302M ED202 04	Mahalakshmi.R	X	X	X	X	X	X	X	X	X	X	X	X	X	X	X
55.	2302M ED202 05	Preethi.N	X	X	X	X	X	X	X	X	X	X	X	X	X	X	X
56.	2302M ED202 06	AbiramiR	X	X	X	X	X	X	X	X	X	X	X	X	X	X	X
57.	2302M ED202 07	P. Ganesan	X	X	X	X	X	X	X	X	X	X	X	X	X	X	X
58.	2302M ED202 08	V. JayaKumar	X	X	X	X	X	X	X	X	X	X	X	X	X	X	X
59.	2302M ED202 09	L. Mekala	X	X	X	X	X	X	X	X	X	X	X	X	X	X	X
60.	2302M ED202 10	S. Annapoorni	X	X	X	X	X	X	X	X	X	X	X	X	X	X	X
61.	2302M ED202 11	R. Bommi	X	X	X	X	X	X	X	X	X	X	X	X	X	X	X
62.	2302M ED202 12	J. Elavarasi	X	X	X	X	X	X	X	X	X	X	X	X	X	X	X
63.	2302M ED202 13	P. Ezhilarasi	X	X	X	X	X	X	X	X	X	X	X	X	X	X	X
64.	2302M ED202 14	K. Joice Mary	X	X	X	X	X	X	X	X	X	X	X	X	X	X	X

HOD

School of Education
Ponnhaiyah Ramajayam Institute of
Science & Technology (PRIST)
THANJAVUR - 613 403

DEAN

School of Education
Ponnhaiyah Ramajayam Institute of
Science & Technology (PRIST)
THANJAVUR - 613 403

65.	2302M ED202 15	P. Krishnapriya	X	X	X	X	X	X	X	X	X	X	X	X	X	X	X	X
66.	2302M ED202 16	T.Kumari	X	X	X	X	X	X	X	X	X	X	X	X	X	X	X	X
67.	2302M ED202 17	S.Manimekalai	X	X	X	X	X	X	X	X	X	X	X	X	X	X	X	X
68.	2302M ED202 18	M.Jeyarani	X	X	X	X	X	X	X	X	X	X	X	X	X	X	X	X
69.	2302M ED202 19	P.Selvarani	X	X	X	X	X	X	X	X	X	X	X	X	X	X	X	X
70.	2302M ED202 20	M.Suseela	X	X	X	X	X	X	X	X	X	X	X	X	X	X	X	X
71.	2302M ED202 21	A.Sirajinnisha	X	X	X	X	X	X	X	X	X	X	X	X	X	X	X	X
72.	2302M ED202 22	T.Sollararasan	X	X	X	X	X	X	X	X	X	X	X	X	X	X	X	X
73.	2302M ED202 23	S.Kavitha	X	X	X	X	X	X	X	X	X	X	X	X	X	X	X	X
74.	2302M ED202 24	T.Sumathi	X	X	X	X	X	X	X	X	X	X	X	X	X	X	X	X
75.	2302M ED202 25	A.T.Banu	X	X	X	X	X	X	X	X	X	X	X	X	X	X	X	X
Staff signature			<i>[Signature]</i>	<i>[Signature]</i>	<i>[Signature]</i>	<i>[Signature]</i>	<i>[Signature]</i>	<i>[Signature]</i>	<i>[Signature]</i>	<i>[Signature]</i>	<i>[Signature]</i>	<i>[Signature]</i>	<i>[Signature]</i>	<i>[Signature]</i>	<i>[Signature]</i>	<i>[Signature]</i>	<i>[Signature]</i>	<i>[Signature]</i>

[Signature]
HOD
School of Education
Ponnaiyah Ramajayam Institute of
Science & Technology (PRIST)
THANJAVUR - 613 403.

[Signature]
DEAN
School of Education
Ponnaiyah Ramajayam Institute of
Science & Technology (PRIST)
THANJAVUR - 613 403.



SCHOOL OF EDUCATION
Value Added Course
COURSE TITLE: TIME MANAGEMENT
Students Attendance Date: (March - 2024)
Academic Year 2023 – 2024

S.No	Reg.No	Name	01	02	04	06	09	11	13	14	16	18	19	20	23	26	27
1.	2302E DTA10 201	MATHAVI.R	X	X	X	X	X	X	X	X	X	X	X	X	X	X	X
2.	2302E DEN10 101	SUKENDRAN.R	X	X	X	X	X	X	X	X	X	X	X	X	X	X	X
3.	230ED MA102 01	KOWSALYA.M	X	X	X	X	X	X	X	X	X	X	X	X	X	X	X
4.	2301E DMA1 0202	KARTHIKA.K	X	X	X	X	X	X	X	X	X	X	X	X	X	X	X
5.	2302E DMA1 0203	UMA.K	X	X	X	X	X	X	X	X	X	X	X	X	X	X	X
6.	2302E DMA1 0204	YAMUNA.M	X	X	X	X	X	X	X	X	X	X	X	X	X	X	X
7.	2302E DPC10 201	SIMRAN.E	X	X	X	X	X	X	X	X	X	X	X	X	X	X	X
8.	2302E DPC10 202	BABY SHALINLL	X	X	X	X	X	X	X	X	X	X	X	X	X	X	X
9.	2302E DPC10 203	HEMA.G	X	X	X	X	X	X	X	X	X	X	X	X	X	X	X
10.	2302E DPC10 204	GOWSALYA.G	X	X	X	X	X	X	X	X	X	X	X	X	X	X	X
11.	2302E DPC10 205	ANUSUYA.D	X	X	X	X	X	X	X	X	X	X	X	X	X	X	X
12.	2302E DPC10 101	AMALRAJ. B	X	X	X	X	X	X	X	X	X	X	X	X	X	X	X
13.	2302E DBS10 201	PARIMALA.S	X	X	X	X	X	X	X	X	X	X	X	X	X	X	X
14.	2302E DBS10 202	PRIYADHARSH INLP	X	X	X	X	X	X	X	X	X	X	X	X	X	X	X

HOD

DEAN

15.	2301E DCS10 201	PRADEEPA.R	X	X	X	X	X	X	X	X	X	X	X	X	X	X	X
16.	2301E DCS10 101	KARTHIK. M	X	X	X	X	X	X	X	X	X	X	X	X	X	X	X
17.	2302E DCO10 201	VEENA.P	X	X	X	X	X	X	X	X	X	X	X	X	X	X	X
18.	2302E DHI10 201	JAYANTHLD	X	X	X	X	X	X	X	X	X	X	X	X	X	X	X
19.	2302E DGO10 201	ABIRAMASUN DHARIS	X	X	X	X	X	X	X	X	X	X	X	X	X	X	X
20.	2302E DTA10 202	C.Amaravathi	X	X	X	X	X	X	X	X	X	X	X	X	X	X	X
21.	2302E DTA10 203	S.Anandhi	X	X	X	X	X	X	X	X	X	X	X	X	X	X	X
22.	2302E DTA10 204	N.Buvaneswari	X	X	X	X	X	X	X	X	X	X	X	X	X	X	X
23.	2302E DTA10 205	S.Juliet	X	X	X	X	X	X	X	X	X	X	X	X	X	X	X
24.	2302E DTA10 206	S.Jenifar	X	X	X	X	X	X	X	X	X	X	X	X	X	X	X
25.	2302E DTA10 207	X.Arockiya Mary	X	X	X	X	X	X	X	X	X	X	X	X	X	X	X
26.	2302E DTA10 208	R.Darathy	X	X	X	X	X	X	X	X	X	X	X	X	X	X	X
27.	2302E DTA10 209	B.Muthulakshmi	X	X	X	X	X	X	X	X	X	X	X	X	X	X	X
28.	2302E DEN10 102	S.Sumitra	X	X	X	X	X	X	X	X	X	X	X	X	X	X	X
29.	2302E DEN10 103	D.Vasumathi	X	X	X	X	X	X	X	X	X	X	X	X	X	X	X
30.	2302E DEN10 104	S.Divya	X	X	X	X	X	X	X	X	X	X	X	X	X	X	X
31.	2302E DEN10 105	V.Chitra	X	X	X	X	X	X	X	X	X	X	X	X	X	X	X

HOD

School of Education
Ponnaiyah Ramajayam Institute of
Science & Technology (PRIST)
THANJAVUR - 613 403.

DEAN

School of Education
Ponnaiyah Ramajayam Institute of
Science & Technology (PRIST)
THANJAVUR - 613 403.

32.	2302E DEN10 106	G.Nandhini	X	X	X	X	X	X	X	X	X	X	X	X	X	X	X
33.	2302E DEN10 107	J.Revathi	X	X	X	X	X	X	X	X	X	X	X	X	X	X	X
34.	2302E DEN10 108	J.Sangeetha	X	X	X	X	X	X	X	X	X	X	X	X	X	X	X
35.	2302E DEN10 109	T.Sasireka	X	X	X	X	X	X	X	X	X	X	X	X	X	X	X
36.	2302E DEN10 110	G.Lakshmi	X	X	X	X	X	X	X	X	X	X	X	X	X	X	X
37.	2302E DEN10 111	T.Sutha	X	X	X	X	X	X	X	X	X	X	X	X	X	X	X
38.	2302E DEN10 112	T.Indira	X	X	X	X	X	X	X	X	X	X	X	X	X	X	X
39.	230ED MA102 02	M.Krishnaveni	X	X	X	X	X	X	X	X	X	X	X	X	X	X	X
40.	230ED MA102 03	G.Regavathi	X	X	X	X	X	X	X	X	X	X	X	X	X	X	X
41.	230ED MA102 04	H. Jahabar Nachiya	X	X	X	X	X	X	X	X	X	X	X	X	X	X	X
42.	230ED MA102 05	V. Kiruba	X	X	X	X	X	X	X	X	X	X	X	X	X	X	X
43.	230ED MA102 06	K.Ambika	X	X	X	X	X	X	X	X	X	X	X	X	X	X	X
44.	230ED MA102 07	L.Angelomary	X	X	X	X	X	X	X	X	X	X	X	X	X	X	X
45.	230ED MA102 02	G.Saranya	X	X	X	X	X	X	X	X	X	X	X	X	X	X	X
46.	230ED MA102 03	R.Amuthakumari	X	X	X	X	X	X	X	X	X	X	X	X	X	X	X
47.	2302E DBS10 204	R.Kalsivani	X	X	X	X	X	X	X	X	X	X	X	X	X	X	X
48.	2302E DBS10 205	P.Kanmani	X	X	X	X	X	X	X	X	X	X	X	X	X	X	X

HOD

School of Education
Ponnaiyah Ramajayam Institute of
Science & Technology (PRIEST)
THANJAVUR - 613 403.

DEAN

School of Education
Ponnaiyah Ramajayam Institute of
Science & Technology (PRIEST)
THANJAVUR - 613 403.















49.	2302E DBS10 206	T.Meena	X	X	X	X	X	X	X	X	X	X	X	X	X	X	X
50.	2302E DBS10 207	K.Sathiyapriya	X	X	X	X	X	X	X	X	X	X	X	X	X	X	X
51.	2302M ED202 01	Jeipreethi kanggeyavelu.K	X	X	X	X	X	X	X	X	X	X	X	X	X	X	X
52.	2302M ED202 02	Noor nisha.A	X	X	X	X	X	X	X	X	X	X	X	X	X	X	X
53.	2302M ED202 03	Nivethitha.R	X	X	X	X	X	X	X	X	X	X	X	X	X	X	X
54.	2302M ED202 04	Mahalakshmi.R	X	X	X	X	X	X	X	X	X	X	X	X	X	X	X
55.	2302M ED202 05	Preethi.N	X	X	X	X	X	X	X	X	X	X	X	X	X	X	X
56.	2302M ED202 06	AbiramiR	X	X	X	X	X	X	X	X	X	X	X	X	X	X	X
57.	2302M ED202 07	P. Ganesan	X	X	X	X	X	X	X	X	X	X	X	X	X	X	X
58.	2302M ED202 08	V. JayaKumar	X	X	X	X	X	X	X	X	X	X	X	X	X	X	X
59.	2302M ED202 09	L. Mekala	X	X	X	X	X	X	X	X	X	X	X	X	X	X	X
60.	2302M ED202 10	S. Annapoorni	X	X	X	X	X	X	X	X	X	X	X	X	X	X	X
61.	2302M ED202 11	R. Bommi	X	X	X	X	X	X	X	X	X	X	X	X	X	X	X
62.	2302M ED202 12	J. Elavarasi	X	X	X	X	X	X	X	X	X	X	X	X	X	X	X
63.	2302M ED202 13	P. Ezhilarasi	X	X	X	X	X	X	X	X	X	X	X	X	X	X	X
64.	2302M ED202 14	K. Joice Mary	X	X	X	X	X	X	X	X	X	X	X	X	X	X	X

HOD

School of Education
Ponniyah Ramajayam Institute of
Science & Technology (PRIIST)
THANJAVUR - 613 403.

DEAN

School of Education
Ponniyah Ramajayam Institute of
Science & Technology (PRIIST)
THANJAVUR - 613 403.

65.	2302M ED202 15	P. Krishnapriya	X	X	X	X	X	X	X	X	X	X	X	X	X	X	X
66.	2302M ED202 16	T.Kumari	X	X	X	X	X	X	X	X	X	X	X	X	X	X	X
67.	2302M ED202 17	S.Manimekalai	X	X	X	X	X	X	X	X	X	X	X	X	X	X	X
68.	2302M ED202 18	M.Jeyarani	X	X	X	X	X	X	X	X	X	X	X	X	X	X	X
69.	2302M ED202 19	P.Selvarani	X	X	X	X	X	X	X	X	X	X	X	X	X	X	X
70.	2302M ED202 20	M.Suseela	X	X	X	X	X	X	X	X	X	X	X	X	X	X	X
71.	2302M ED202 21	A.Sirajinnisha	X	X	X	X	X	X	X	X	X	X	X	X	X	X	X
72.	2302M ED202 22	T.Sollararasan	X	X	X	X	X	X	X	X	X	X	X	X	X	X	X
73.	2302M ED202 23	S.Kavitha	X	X	X	X	X	X	X	X	X	X	X	X	X	X	X
74.	2302M ED202 24	T.Sumathi	X	X	X	X	X	X	X	X	X	X	X	X	X	X	X
75.	2302M ED202 25	A.T.Banu	X	X	X	X	X	X	X	X	X	X	X	X	X	X	X
Staff signature																	

HOD
School of Education
Ponnaiyah Ramajayam Institute of
Science & Technology (PRIST)
THANJAVUR - 613 403.

DEAN
School of Education
Ponnaiyah Ramajayam Institute of
Science & Technology (PRIST)
THANJAVUR - 613 403.



SCHOOL OF EDUCATION
Value Added Course
COURSE TITLE: TIME MANAGEMENT
Students Attendance Date: (April - 2024)
Academic Year 2023 – 2024

S.No	Reg.No	Name	02	03	04	06	08	10	13	15	16	18	19	20	23	24	27
1.	2302E DTA10 201	MATHAVI.R	X	X	X	X	X	X	X	X	X	X	X	X	X	X	X
2.	2302E DEN10 101	SUKENDRAN.R	X	X	X	X	X	X	X	X	X	X	X	X	X	X	X
3.	2302E MA102 01	KOWSALYA.M	X	X	X	X	X	X	X	X	X	X	X	X	X	X	X
4.	2301E DMA1 0202	KARTHIKA.K	X	X	X	X	X	X	X	X	X	X	X	X	X	X	X
5.	2302E DMA1 0203	UMA.K	X	X	X	X	X	X	X	X	X	X	X	X	X	X	X
6.	2302E DMA1 0204	YAMUNA.M	X	X	X	X	X	X	X	X	X	X	X	X	X	X	X
7.	2302E DPC10 201	SIMRAN.E	X	X	X	X	X	X	X	X	X	X	X	X	X	X	X
8.	2302E DPC10 202	BABY SHALINI.L	X	X	X	X	X	X	X	X	X	X	X	X	X	X	X
9.	2302E DPC10 203	HEMA.G	X	X	X	X	X	X	X	X	X	X	X	X	X	X	X
10.	2302E DPC10 204	GOWSALYA.G	X	X	X	X	X	X	X	X	X	X	X	X	X	X	X
11.	2302E DPC10 205	ANUSUYA.D	X	X	X	X	X	X	X	X	X	X	X	X	X	X	X
12.	2302E DPC10 101	AMALRAJ. B	X	X	X	X	X	X	X	X	X	X	X	X	X	X	X
13.	2302E DBS10 201	PARIMALA.S	X	X	X	X	X	X	X	X	X	X	X	X	X	X	X
14.	2302E DBS10 202	PRIYADHARSH INI.L.P	X	X	X	X	X	X	X	X	X	X	X	X	X	X	X

HOD

School of Education
Ponnaiyah Ramajayam Institute of
Science & Technology (PRIST)
THANJAVUR - 613 403.

DEAN

School of Education
Ponnaiyah Ramajayam Institute of
Science & Technology (PRIST)
THANJAVUR - 613 403.

15.	2301E DCS10 201	PRADEEPA.R	X	X	X	X	X	X	X	X	X	X	X	X	X	X	X
16.	2301E DCS10 101	KARTHIK. M	X	X	X	X	X	X	X	X	X	X	X	X	X	X	X
17.	2302E DCO10 201	VEENA.P	X	X	X	X	X	X	X	X	X	X	X	X	X	X	X
18.	2302E DHI10 201	JAYANTHLD	X	X	X	X	X	X	X	X	X	X	X	X	X	X	X
19.	2302E DGO10 201	ABIRAMASUN DHARLS	X	X	X	X	X	X	X	X	X	X	X	X	X	X	X
20.	2302E DTA10 202	C.Amaravathi	X	X	X	X	X	X	X	X	X	X	X	X	X	X	X
21.	2302E DTA10 203	S.Anandhi	X	X	X	X	X	X	X	X	X	X	X	X	X	X	X
22.	2302E DTA10 204	N.Buveneswari	X	X	X	X	X	X	X	X	X	X	X	X	X	X	X
23.	2302E DTA10 205	S.Juliet	X	X	X	X	X	X	X	X	X	X	X	X	X	X	X
24.	2302E DTA10 206	S.Jenifar	X	X	X	X	X	X	X	X	X	X	X	X	X	X	X
25.	2302E DTA10 207	X.Arockiya Mary	X	X	X	X	X	X	X	X	X	X	X	X	X	X	X
26.	2302E DTA10 208	R.Darathy	X	X	X	X	X	X	X	X	X	X	X	X	X	X	X
27.	2302E DTA10 209	B.Muthulakshmi	X	X	X	X	X	X	X	X	X	X	X	X	X	X	X
28.	2302E DEN10 102	S.Sumitra	X	X	X	X	X	X	X	X	X	X	X	X	X	X	X
29.	2302E DEN10 103	D.Vasumathi	X	X	X	X	X	X	X	X	X	X	X	X	X	X	X
30.	2302E DEN10 104	S.Divya	X	X	X	X	X	X	X	X	X	X	X	X	X	X	X
31.	2302E DEN10 105	V.Chitra	X	X	X	X	X	X	X	X	X	X	X	X	X	X	X



100

School of Education

Ponnamyiah Ramajayam Institute of
Science & Technology (PRIST)
THANJAVUR - 613 403.



DEAN

School of Education
Ponnamyiah Ramajayam Institute of
Science & Technology (PRIST)
THANJAVUR - 613 403.

32.	2302E DEN10 106	G.Nandhini	X	X	X	X	X	X	X	X	X	X	X	X	X	X	X	X
33.	2302E DEN10 107	J.Revathi	X	X	X	X	X	X	X	X	X	X	X	X	X	X	X	X
34.	2302E DEN10 108	J.Sangeetha	X	X	X	X	X	X	X	X	X	X	X	X	X	X	X	X
35.	2302E DEN10 109	T.Sasireka	X	X	X	X	X	X	X	X	X	X	X	X	X	X	X	X
36.	2302E DEN10 110	G.Lakshmi	X	X	X	X	X	X	X	X	X	X	X	X	X	X	X	X
37.	2302E DEN10 111	T.Sutha	X	X	X	X	X	X	X	X	X	X	X	X	X	X	X	X
38.	2302E DEN10 112	T.Indira	X	X	X	X	X	X	X	X	X	X	X	X	X	X	X	X
39.	230ED MA102 02	M.Krishnaveni	X	X	X	X	X	X	X	X	X	X	X	X	X	X	X	X
40.	230ED MA102 03	G.Regavathi	X	X	X	X	X	X	X	X	X	X	X	X	X	X	X	X
41.	230ED MA102 04	H. Jahabar Nachiya	X	X	X	X	X	X	X	X	X	X	X	X	X	X	X	X
42.	230ED MA102 05	V. Kiruba	X	X	X	X	X	X	X	X	X	X	X	X	X	X	X	X
43.	230ED MA102 06	K.Ambika	X	X	X	X	X	X	X	X	X	X	X	X	X	X	X	X
44.	230ED MA102 07	L.Angelomary	X	X	X	X	X	X	X	X	X	X	X	X	X	X	X	X
45.	230ED MA102 02	G.Saranya	X	X	X	X	X	X	X	X	X	X	X	X	X	X	X	X
46.	230ED MA102 03	R.Amuthakumari	X	X	X	X	X	X	X	X	X	X	X	X	X	X	X	X
47.	2302E DBS10 204	R.Kalaivani	X	X	X	X	X	X	X	X	X	X	X	X	X	X	X	X
48.	2302E DBS10 205	P.Kanmani	X	X	X	X	X	X	X	X	X	X	X	X	X	X	X	X

HOD

School of Education
Ponnaiyah Ramajayam Institute of
Science & Technology (PRIST)
THANJAVUR - 613 403.

DEAN

School of Education
Ponnaiyah Ramajayam Institute of
Science & Technology (PRIST)
THANJAVUR - 613 403















49.	2302E DBS10 206	T.Meena	X	X	X	X	X	X	X	X	X	X	X	X	X	X	X
50.	2302E DBS10 207	K.Sathiyapriya	X	X	X	X	X	X	X	X	X	X	X	X	X	X	X
51.	2302M ED202 01	Jeipreethi kanggeyavelu.K	X	X	X	X	X	X	X	X	X	X	X	X	X	X	X
52.	2302M ED202 02	Noor nisha.A	X	X	X	X	X	X	X	X	X	X	X	X	X	X	X
53.	2302M ED202 03	Nivethitha.R	X	X	X	X	X	X	X	X	X	X	X	X	X	X	X
54.	2302M ED202 04	Mahalakshmi.R	X	X	X	X	X	X	X	X	X	X	X	X	X	X	X
55.	2302M ED202 05	Preethi.N	X	X	X	X	X	X	X	X	X	X	X	X	X	X	X
56.	2302M ED202 06	AbiramiR	X	X	X	X	X	X	X	X	X	X	X	X	X	X	X
57.	2302M ED202 07	P. Ganesan	X	X	X	X	X	X	X	X	X	X	X	X	X	X	X
58.	2302M ED202 08	V. JayaKumar	X	X	X	X	X	X	X	X	X	X	X	X	X	X	X
59.	2302M ED202 09	L. Mekala	X	X	X	X	X	X	X	X	X	X	X	X	X	X	X
60.	2302M ED202 10	S. Annapoorni	X	X	X	X	X	X	X	X	X	X	X	X	X	X	X
61.	2302M ED202 11	R. Bommi	X	X	X	X	X	X	X	X	X	X	X	X	X	X	X
62.	2302M ED202 12	J. Elavarasi	X	X	X	X	X	X	X	X	X	X	X	X	X	X	X
63.	2302M ED202 13	P. Ezhilarasi	X	X	X	X	X	X	X	X	X	X	X	X	X	X	X
64.	2302M ED202 14	K. Joice Mary	X	X	X	X	X	X	X	X	X	X	X	X	X	X	X

HOD

School of Education
Ponnaiyah Ramajayam Institute of
Science & Technology (PRIST)
THANJAVUR - 613 403.

DEAN

School of Education
Ponnaiyah Ramajayam Institute of
Science & Technology (PRIST)
THANJAVUR - 613 403.

65.	2302M ED202 15	P. Krishnapriya	X	X	X	X	X	X	X	X	X	X	X	X	X	X	X	X
66.	2302M ED202 16	T.Kumari	X	X	X	X	X	X	X	X	X	X	X	X	X	X	X	X
67.	2302M ED202 17	S.Manimekalai	X	X	X	X	X	X	X	X	X	X	X	X	X	X	X	X
68.	2302M ED202 18	M.Jeyarani	X	X	X	X	X	X	X	X	X	X	X	X	X	X	X	X
69.	2302M ED202 19	P.Selvarani	X	X	X	X	X	X	X	X	X	X	X	X	X	X	X	X
70.	2302M ED202 20	M.Suseela	X	X	X	X	X	X	X	X	X	X	X	X	X	X	X	X
71.	2302M ED202 21	A.Sirajinnisha	X	X	X	X	X	X	X	X	X	X	X	X	X	X	X	X
72.	2302M ED202 22	T.Sollararasan	X	X	X	X	X	X	X	X	X	X	X	X	X	X	X	X
73.	2302M ED202 23	S.Kavitha	X	X	X	X	X	X	X	X	X	X	X	X	X	X	X	X
74.	2302M ED202 24	T.Sumathi	X	X	X	X	X	X	X	X	X	X	X	X	X	X	X	X
75.	2302M ED202 25	A.T.Banu	X	X	X	X	X	X	X	X	X	X	X	X	X	X	X	X
Staff signature																		

HOD

School of Education
Ponnaiyah Ramajayam Institute of
Science & Technology (PRIST)
THANJAVUR - 613 403

DEAN

School of Education
Ponnaiyah Ramajayam Institute of
Science & Technology (PRIST)
THANJAVUR - 613 403.



PONNAIYAH RAMAJAYAM INSTITUTE OF
SCIENCE & TECHNOLOGY (PRIST)

DECLARED AS DEEMED TO BE UNIVERSITY
U/s 3 of UGC Act 1956

SCHOOL OF EDUCATION

VALUE ADDED COURSE

CERTIFICATE OF APPRECIATION

This is to certify that Mr./Ms. SUKENDRAN. R, Reg. No. 2302EDEN10101
has completed the Value Added Certificate course on Mental Health from
September 2023 to November 2023 during the academic year 2023-24.

Course Coordinator

School of Education
Ponnaiyah Ramajayam Institute of
Science & Technology (PRIST)
TRANJAVUR - 613 403.

HOD

HOD
School of Education
Ponnaiyah Ramajayam Institute of
Science & Technology (PRIST)
TRANJAVUR - 613 403.

Dean
DEAN

School of Education
Ponnaiyah Ramajayam Institute of
Science & Technology (PRIST)
TRANJAVUR - 613 403.



**PONNAIYAH RAMAJAYAM INSTITUTE OF
SCIENCE & TECHNOLOGY (PRIST)**

DECLARED AS DEEMED TO BE UNIVERSITY
U/S 3 of UGC Act, 1956

**SCHOOL OF EDUCATION
VALUE ADDED COURSE
CERTIFICATE OF APPRECIATION**

This is to certify that Mr./Ms. **AMALRAJ**, Reg. No. 2302EDPC10101 has completed the Value Added Certificate course on Environmental Awareness from September 2023 to November 2023 during the academic year 2023-24.

Course Coordinator

School of Education
Ponnaiyah Ramajayam Institute of
Science & Technology (PRIST)
THANJAVUR - 613 403

**HOD
HOD**

School of Education
Ponnaiyah Ramajayam Institute of
Science & Technology (PRIST)
THANJAVUR - 613 403

**Dean
DEAN**

School of Education
Ponnaiyah Ramajayam Institute of
Science & Technology (PRIST)
THANJAVUR - 613 403



**PONNAIYAH RAMAJAYAM INSTITUTE OF
SCIENCE & TECHNOLOGY (PRIST)**

Declared as DEEMED TO BE UNIVERSITY
U/s 3 of UGC Act 1956

**SCHOOL OF EDUCATION
VALUE ADDED COURSE**

CERTIFICATE OF APPRECIATION

This is to certify that ~~Mr.~~/Ms. KOWSALYA.M, Reg. No. 2302EDMA10201 has completed the Value Added Certificate course on Basics of laptop maintenance and OS installation from February 2024 to April 2024 during the academic year 2023-24.

Course Coordinator

School of Education
Ponnaiyah Ramajayam Institute of
Science & Technology (PRIST)
THANJAVUR - 613 403

HOD
HOD

School of Education
Ponnaiyah Ramajayam Institute of
Science & Technology (PRIST)
THANJAVUR - 613 403

Dean
DEAN

School of Education
Ponnaiyah Ramajayam Institute of
Science & Technology (PRIST)
THANJAVUR - 613 403



**PONNAIYAH RAMAJAYAM INSTITUTE OF
SCIENCE & TECHNOLOGY (PRIST)**

Declared as DEEMED TO BE UNIVERSITY
by 3 of UGC Act 1956

**SCHOOL OF EDUCATION
VALUE ADDED COURSE
CERTIFICATE OF APPRECIATION**

This is to certify that ~~Mr.~~/Ms. PARIMALA.S, Reg. No. 2302EDBS10201 has completed the Value Added Certificate course 'on Time management from' February 2024 to April 2024 during the academic year 2023-24.

Course Coordinator
School of Education

Ponnaiyah Ramajayam Institute of
Science & Technology (PRIST)
THANJAVUR - 613 403

HOD
HOD

School of Education
Ponnaiyah Ramajayam Institute of
Science & Technology (PRIST)
THANJAVUR - 613 403.

Dean
DEAN

School of Education
Ponnaiyah Ramajayam Institute of
Science & Technology (PRIST)
THANJAVUR - 613 403.



PONNAIYAH RAMAJAYAM INSTITUTE OF
SCIENCE & TECHNOLOGY (PRIST)

Declared as DEEMED TO BE UNIVERSITY
U/S 3 of UGC Act, 1956

SCHOOL OF EDUCATION

VALUE ADDED COURSE

CERTIFICATE OF APPRECIATION

This is to certify that ~~Mr.~~/Ms. Mathavi.R Reg. No. 2302EDTA10201 has completed the Value Added Certificate course on General Awareness from September 2023 to November 2023 during the academic year 2023 - 2024.

Course Coordinator

Ponnaiyah Ramajayam Institute of
Science & Technology (PRIST)
THANJAVUR - 613 403

HOD
HOD

School of Education
Ponnaiyah Ramajayam Institute of
Science & Technology (PRIST)
THANJAVUR - 613 403

Dean
DEAN

School of Education
Ponnaiyah Ramajayam Institute of
Science & Technology (PRIST)
THANJAVUR - 613 403



**PONNAIYAH RAMAJAYAM INSTITUTE OF
SCIENCE & TECHNOLOGY (PRIST)**

Declared as DEEMED TO BE UNIVERSITY
U/s 3 of UGC Act, 1956

SCHOOL OF ARTS AND SCIENCE

DEPARTMENT OF MATHEMATICS

ADD-ON COURSE

CIRCULAR

Department of Mathematics / ODD & EVEN /2023-2024

It is hereby informed that the department is organizing add on Certificate course for the academic year 2023-2024. Students those who are interested register your name to the Department of Mathematics.

DEAN

Dean

- Copy to
- Registrar, Ponnaiyah Ramajayam Institute of Science & Technology (PRIST)
 - Dean, School of Arts & Science, Ponnaiyah Ramajayam Institute of Science & Technology (PRIST)
 - All Heads, Ponnaiyah Ramajayam Institute of Science & Technology, Thanjavur - 613 403
 - File

HOD/MATHS

H.O.D.

DEPARTMENT OF MATHEMATICS
PRIST DEEMED TO BE UNIVERSITY
THANJAVUR - 613 403



**PONNAIYAH RAMAJAYAM INSTITUTE OF
SCIENCE & TECHNOLOGY (PRIST)**

Declared as DEEMED TO BE UNIVERSITY
U/s 3 of UGC Act, 1956

**SCHOOL OF ARTS AND SCIENCE
DEPARTMENT OF MATHEMATICS**

This is to inform all the UG and PG students of Mathematics Department that the value added programme classes for Odd & Even Semester academic Year 2023-2024 will be commenced from 07-07-2023. Hence requesting all the registered students to attend the class without fail.

Sl. No	Branch Name	Course Type	Course Offered
1	Mathematics	Diploma	MATHEMATICS FOR RECRUITMENT EXAM
2	Mathematics	Diploma	MATLAB
3	Mathematics	Certificate	VEDIC MATHEMATICS-I
4	Mathematics	Certificate	LIE GROUPS AND LIE ALGEBRA
5	Mathematics	Certificate	MATHEMATICAL SOFTWARE

H. O. D.

H.O.D.

DEPARTMENT OF MATHEMATICS
PRIST DEEMED TO BE UNIVERSITY
THANJAVUR - 613 403

2

Dean

[Signature]

School of Arts & Science
Ponnaiyah Ramajayam Institute of
Science & Technology (PRIST)
Deemed to be University
Valiam, Thanjavur - 613 403



ABOUT THE UNIVERSITY

PRIST University, Periyarathurai, Tamil Nadu, India, made a leap into the Academic Domain, with the establishment of Sri Ram Institute of Computer Science and Technology in 1985. Over time, various institutions of higher learning such as Arts and Science College, College of Engineering and Technology, College of Education, Research Institute, Polytechnic colleges are added further to the PRIST group. Today, PRIST comprises a massive student base, spread across a whole array of campuses such as Poduberry, Trichy, Kumbakonam, Chennai and Madurai. The Academic research extends right from school education up to the level of the Ph.D. Doctoral programmes in a rich array of disciplines such as Medicine, Engineering, Arts & Science, education, Pharmacy, Management, Technology etc.

ABOUT FACULTY OF MATHEMATICS

High quality teaching across a broad range of disciplines Promoting world class research in mathematics. Dedicates the communication expansion and integration of knowledge through excellence and to make the institution campus as a centre of academic excellence in mathematics.

REGISTRATION FORM

Name of the student: _____
Department: _____
Gender: _____
Register Number: _____
Address for communication: _____
Mobile number: _____
Email Address: _____

Name and Signature of the Candidate



PRIST INSTITUTE OF SCIENCE & TECHNOLOGY
Periyarathurai, Tamil Nadu, India
PRIST GROUP OF INSTITUTIONS

**ADD-ON COURSES
Diploma in**

**MATHEMATICS FOR
RECRUITMENT EXAM**
22512MBRE

School of Arts and Science
Department of Mathematics

Dean

[Handwritten Signature]

School of Arts & Science
Periyarathurai Ramalingam Institute of
Science & Technology (PRIST)
Dedicated to the University
Vaduthi, Thanjavur - 613 401.



ABOUT THE UNIVERSITY

PRIET University, PonnaiyahRamajayam Institutions, made a foray into the Academic Domain, with the establishment of Sri Ram Institute of Computer Science and Technology in 1985. Over time, various institutions of higher learning such as Arts and Science College, College of Engineering and Technology, College of Education, Research Institution, Polytechnic college are added feathers to the PRIET crown. Today, PRIET commands a massive student base, spread across a whole array of campuses such as Paduberry, Trichy, Kumbakonam, Chennai and Madurai. The Academic research extends right form school education upto the level of the Ph.D Doctoral programmes in a rich array of disciplines such as Medicine, Engineering, Arts & Science, education , Pharmacy, Management, Technology etc.

ABOUT FACULTY OF MATHEMATICS

High quality teaching across a broad range of disciplines Promoting world class research in mathematics. Dedicate the communication expansion and integration of knowledge through excellence and to make the institution campus as a centre of academic excellence in mathematics.

REGISTRATION FORM

Name of the student:

Department :

Gender :

Register Number :

Address for communication:.....

Mobile number:

Email Address:

Name and Signature of the Candidate



PONNAIYAH RAMAJAYAM INSTITUTE OF SCIENCE & TECHNOLOGY (PRIET)
 Declared as DEEMED TO BE UNIVERSITY
 Uts 2 of 001 Act 1996

**ADD-ON COURSES
 Diploma in**

**MATLAB
 21VADM1**

School of Arts and Science
 Department of Mathematics
 Dean

School of Arts & Science
 Ponnaiyah Ramajayam Institute of
 Science & Technology (PRIET)
 Deemed to be University
 Vellam, Thanjavur - 613 403.

P. Arigee
 DEPARTMENT OF MATHEMATICS
 PRIST DEEMED TO BE UNIVERSITY
 THANJAVUR - 613 403



ABOUT THE UNIVERSITY

PRIST University, PonnaiyahRamajayam Institutions, made a ferry into the Academic Domain, with the establishment of Sri Ram Institute of Computer Science and Technology in 1985. Over time, various institutions of higher learning such as Arts and Science College, College of Engineering and Technology, College of Education, Research Institution, Polytechnic college are added feathers to the PRIST crown. Today, PRIST commands a massive student base, spread across a whole array of campuses such as Pudukkottai, Tiruvarur, Kumbakonam, Chennai and Madurai. The Academic research extends right from school education upto the level of the Ph.D Doctoral programmes in a rich array of disciplines such as Medicine, Engineering, Arts & Science, education, Pharmacy, Management, Technology etc.

ABOUT FACULTY OF MATHEMATICS

High quality teaching across a broad range of disciplines. Promoting world class research in mathematics. Dedicate the communication expansion and integration of knowledge through excellence and to make the institution campus as a centre of academic excellence in mathematics.

REGISTRATION FORM

Name of the student:
 Department :
 Gender :
 Register Number :
 Address for communication:.....
 Mobile number:
 Email Address:

Name and Signature of the Candidate



PONNAYAH RAMAJAYAM INSTITUTE OF SCIENCE & TECHNOLOGY PRIST

Deemed to be University
 Uin 3 of 1987 Act 1986

**ADD-ON COURSES
 Certificate in**

VEDIC MATHEMATICS – I

23512VACVMI

**School of Arts and Science
 Department of Mathematics**

Dean

School of Arts & Science
 Ponnaiyah Ramajayam Institute of
 Science & Technology (PRIST)
 Deemed to be University
 Vabiam, Thanjavur - 613 403.

Dr. Divyapriya

DEPARTMENT OF MATHEMATICS
 PRIST DEEMED TO BE UNIVERSITY
 THANJAVUR • 613 403



PRIST
DEEMED TO BE
UNIVERSITY
NAAC ACCREDITED
THANJAVUR - 613 403 - TAMIL NADU

**ADD-ON COURSES
Certificate in**

**LIE GROUPS & LIE ALGEBRAS
22512LGLA**

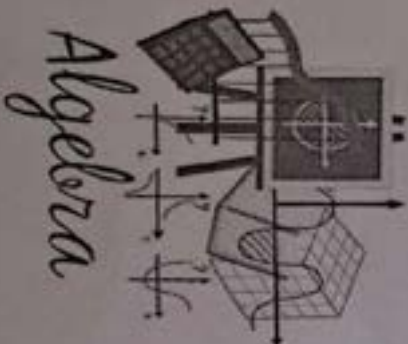

MathsWork.com - 1739465349

ABOUT THE UNIVERSITY

PRIST University, Ponnalyahkamajayam Institutions, made a foray into the Academic Domain, with the establishment of Sri Ram Institute of Computer Science and Technology in 1985. Over time, various institutions of higher learning such as Arts and Science College, College of Engineering and Technology, College of Education, Research Institution, Polytechnic college are added feathers to the PRIST crown. Today, PRIST commands a massive student base, spread across a whole array of campuses such as Pudukkottai, Trichy, Kumbhakonam, Chennai and Madurai. The Academic research extends right from school education upto the level of the Ph.D Doctoral programmes in a rich array of disciplines such as Medicine, Engineering, Arts & Science, education, Pharmacy, Management, Technology etc.

ABOUT FACULTY OF MATHEMATICS

High quality teaching across a broad range of disciplines. Promoting world class research in mathematics. Dedicate the communication expansion and integration of knowledge through excellence and to make the institution campus as a centre of academic excellence in mathematics.

REGISTRATION FORM

Name of the student:

Department :

Gender :

Register Number :

Address for communication:

Mobile number:

Email Address:

Name and Signature of the Candidate

School of Arts and Science
Department of Mathematic

Dean

School of Arts & Science
Ponnelyah Ramajayam Institute of
Science & Technology (PRIST)
Deemed to be University
Vallam, Thanjavur - 613 403

DEPARTMENT OF MATHEMATICS
PRIST DEEMED TO BE UNIVERSITY
THANJAVUR - 613 403



ABOUT THE UNIVERSITY

PRISt University, Ponnaiyah Ramajayam Institutions, made a foray into the Academic Domain, with the establishment of Sri Ram Institute of Computer Science and Technology in 1985. Over time, various institutions of higher learning such as Arts and Science College, College of Engineering and Technology, College of Education, Research Institution, Polytechnic college are added feathers to the PRISt crown. Today, PRISt commands a massive student base, spread across a whole array of campuses such as Puducherry, Trichy, Kumbakonam, Chennai and Madurai. The Academic research extends right from school education upto the level of the Ph.D Doctoral programmes in a rich array of disciplines such as Medicine, Engineering, Arts & Science, education, Pharmacy, Management, Technology etc.

ABOUT FACULTY OF MATHEMATICS

High quality teaching across a broad range of disciplines Promoting world class research in mathematics. Dedicate the communication expansion and integration of knowledge through excellence and to make the Institution campus as a centre of academic excellence in mathematics.

REGISTRATION FORM

Name of the student:

Department :

Gender :

Register Number :

Address for communication:

Mobile number:

Email Address:

Name and Signature of the Candidate



PONNAYAH RAMAJAYAM INSTITUTE OF SCIENCE & TECHNOLOGY (PRISt)
 Dorned to be UNIVERSITY
 Wt 3 rd Str. No. 1158

**ADD-ON COURSES
 Certificate in**

MATHEMATICAL SOFTWARE

23512VACMS

**School of Arts and Science
 Department of Mathematics**

Dean

School of Arts & Science
 Ponnaiyah Ramajayam Institute of
 Science & Technology (PRISt)
 Dorned to be University
 Villiam, Thanjavur - 813 403.

Department of Mathematics
PRISt DEEMED TO BE UNIVERSITY
 THANJAVUR - 813 403



**PONNAIYAH RAMAJAYAM INSTITUTE OF
SCIENCE & TECHNOLOGY (PRIST)**

Declared as DEEMED TO BE UNIVERSITY
U/s 3 of UGC Act, 1956

SCHOOL OF ARTS AND SCIENCE

DEPARTMENT OF MATHEMATICS

ADD-ON COURSE

CIRCULAR

Department of Mathematics / ODD & EVEN /2023-2024

It is hereby informed that the department is organizing add on Certificate course for the academic year 2023-2024. Students those who are interested register your name to the Department of Mathematics.

DEAN

Dean

- Copy to
- Registrar, Ponnaiyah Ramajayam Institute of Science & Technology (PRIST)
 - Dean, School of Arts & Science, Deemed to be University, Thanjavur - 613 403
 - All Heads, ... Thanjavur - 613 403
 - File

HOD/MATHS

H.O.D.

DEPARTMENT OF MATHEMATICS
PRIST DEEMED TO BE UNIVERSITY
THANJAVUR - 613 403



**PONNAIYAH RAMAJAYAM INSTITUTE OF
SCIENCE & TECHNOLOGY (PRIST)**

Declared as DEEMED-TO-BE-UNIVERSITY
U/s 3 of UGC Act, 1956

**SCHOOL OF ARTS AND SCIENCE
DEPARTMENT OF MATHEMATICS**

This is to inform all the UG and PG students of Mathematics Department that the value added programme classes for Odd & Even Semester academic Year 2023-2024 will be commenced from 07-07-2023. Hence requesting all the registered students to attend the class without fail.

Sl. No	Branch Name	Course Type	Course Offered
1	Mathematics	Diploma	MATHEMATICS FOR RECRUITMENT EXAM
2	Mathematics	Diploma	MATLAB
3	Mathematics	Certificate	VEDIC MATHEMATICS-I
4	Mathematics	Certificate	LIE GROUPS AND LIE ALGEBRA
5	Mathematics	Certificate	MATHEMATICAL SOFTWARE

S. Siganam

H.O.D.

DEPARTMENT OF MATHEMATICS
PRIST DEEMED-TO-BE-UNIVERSITY
THANJAVUR - 613 403

2

Dean

S. Siganam

School of Arts & Science
Ponnaiyah Ramajayam Institute of
Science & Technology (PRIST)
Deemed to be University
Vallam, Thanjavur - 613 403

Course Code	22512MRE	TITLE OF THE COURSE			
Value Added		MATHEMATICS FOR RECRUITMENT EXAM			
Pre-requisite		Knowledge in Competitive oriented Skill			
		Course Objectives			
		L	T	P	C
		4	1	-	4
		Syllabus Version		2022-23	

The main objectives of this course are to:

1. Understand the operations and functions of R Programming
2. Perform statistical analysis using built-in functions
3. Learn and write customized program for mathematical and statistical problems

On the successful completion of the course, student will be able to:

Expected Course Outcomes

1	Understand the basics Maths Skill	K2
2	Apply the logical skills for performing statistical analysis	K4
3	Use appropriate plots, charts and diagrams for all kinds of data	K3
4	Perform parametric methods	K3
5	Write and execute the coding theory	K6

Unit:1	Numbers and Basic operations, Fractions and Decimal Numbers, Percentage, Profit and Loss, Simple and Compound Interest, Ratio and Proportion	K1 - Remember; K2 - Understand; K3 - Apply; K4 - Analyze; K5 - Evaluate; K6 - Create
Unit:2	Time and Distance, Time and Work, Speed, Average,	
Unit:3	Laws of Exponents, Menstruation.	
Unit:4	Progression, Series, Problems of Mathematical Signs, Finding Position, Analogy, Odd one out	
Unit:5	Coding and Decoding, Family Relations, Direction Problems, Time and Angles, Time in a clock and it's Reflection's, Date and Calendar	

Books for Study		
1	Handbook of Mathematics by Arihant Experts	
2	For Competitive Exams Vedic Mathematics by Rammandan Shastri	
3	Objective Arithmetic (SSC & Railway Exam Special) by R.S Ayyarwal	
Reference Books		
1	Quantitative Aptitude for Competitive Examinations Abhijit Guha	

Dean



Course Code	21VADM1	TITLE OF THE COURSE			
Value Added		MATLAB			
Pre-requisite	Knowledge in Mathematics	Optimistic technique oriented Skill	L	T	P
			4	1	-
					4
		Syllabus Version	2021-22		

Course Objectives

- The main objectives of this course are to:
1. Understand the operations and functions of Statistics
 2. Perform statistical analysis using computer language
 3. Learn and write customized program for mathematical and statistical problems

Expected Course Outcomes

On the successful completion of the course, student will be able to:					
1	To bridge the skill gaps and make students industry ready.				K2
2	To provide an opportunity to students to develop inter-disciplinary skills				K4
3	To impart the Knowledge to the students with MATLAB software. [This enhances programming knowledge in Research and Development].				K3
4	To provide a working introduction to the Matlab technical computing environment. [Themes of data analysis, visualization, and programming].				K3
5	Break a complex task up into smaller, simpler tasks				K6
K1 - Remember; K2 - Understand; K3 - Apply; K4 - Analyze; K5 - Evaluate; K6 -- Create					
Unit:1	Basics of Matlab and MATLAB Compiler :The Matlab user interface ,Working with Matlab data types ,Creating matrices and arrays				
Unit:2	Operators and control statements ,Using scripts and functions ,Data import and export ,Using the graphical features				
Unit:3	Programming with simple examples: Operators and control statements				
Unit:4	Discussion of Toolboxes with Applications , Signal Processing, Image Acquisition Toolbox , Image Processing , Neural Network , Fuzzy Logic Toolbox				
Unit:5	Simulink and Hardware Interfacing (Using Kits: Lego, Raspberry Pi, Mind storms etc)				
Books for Study					
1	[1] http://www.eng-tips.com/threadminder.cfm?pid=575 [2] http://www.matlabtutorials.com/mathforum/				

B. Divya

H.O.D.

DEPARTMENT OF MATHEMATICS
PRIST DEEMED TO BE UNIVERSITY
THANJAVUR - 606 003

Divya

School of Arts & Science
Ponnaiyah Ramajayam Institute of
Science & Technology (PRIST)
Quered to be University
Vellam, Thanjavur - 613 403.



**PONNAIYAH RAMAJAYAM INSTITUTE OF
SCIENCE & TECHNOLOGY (PRIST)**

Declared as DEEMED TO BE UNIVERSITY
Via 3 of UGC Act, 1956
Vallam, Thanjavur-613403

Value Addition Course -2023-2024

VEDIC MATHEMATICS – I

Subject Code	Category	L	T	P	Credits	Marks		
						CIA	External	Total
23S12VACVMI	Value Added	4	1	-	4	25	75	100
Learning Objectives								
LO1	Foster love for maths and remove its fear through Vedic Mathematics							
LO2	Enhance computation skills in students through Vedic Mathematics							
LO3	Develop logical and analytical thinking							
LO4	Promote joyful learning of mathematics							
LO5	Discuss the rich heritage of mathematical temper of Ancient India							
DETAILS								
I	High Speed Addition and Subtraction Sessions/Lectures Vedic Maths: History of Vedic Maths and its Features - Vedic Maths formulae: Sutras and Upsutras - Addition in Vedic Maths: Without carrying, Dot Method - Subtraction in Vedic Maths: Nikhilam Navatasharamam Dashatah (All from 9 last from 10) - Fraction –Addition and Subtraction							
II	Vedic Math - Miracle Multiplication and Excellent Division Multiplication in Vedic Maths: Base Method (any two numbers upto three digits) -Multiplication by Urthva Tiryak Sutra - Miracle multiplication: Any three-digit number by series of 1's and 9's- Division by Urthva Tiryak Sutra (Vinculum method)							
III	Vedic Maths-Lightening Squares and Rapid Cubes Squares of any two-digit numbers; Base method - Square of numbers ending in 5: Ekadhikena							

Ajay Kumar
DEPARTMENT OF MATHEMATICS
PRIST DEEMED TO BE UNIVERSITY
THANJAVUR - 613 403

30

10/01/2024
P. S. Science
Ponnaiyah Ramajayam Institute of
Science & Technology (PRIST)
Deemed to be University
Vallam, Thanjavur - 613 403.

P. S. Science

IV	Purvena Sutra - Easy square roots; Dwandwa Yoga (duplex) Sutra - Square root of 2; Baudhayana Shulbasutra - Cubing; Yavadunam Sutra Vedic Maths-Enlighten Algebra and Geometry Factoring Quadratic equation: Anurupyena, Adyamadyentanyamantya Sutra -Concept of Baudhayana (Pythagoras) Theorem -Circling a square; Baudhayana Shulbasutra - Concept of pi; Baudhayana Shulbasutra - Concept angle (θ) 0o , 30o , 45o , 60o and 90o ; Baudhayana number
Course Outcomes	
CO1	Overcome the fear of maths
CO2	Improved critical thinking
CO3	Familiarity with the mathematical underpinnings and techniques
CO4	Ability to do basic maths faster and with ease.
CO5	Appreciate the Mathematical advancements of Ancient India.
	PO1
	PO1,PO2
	PO4,PO6
	PO4,PO5, PO6
	PO3, PO8

Text Books (Latest Editions)	
1	The Essential of Vedic Mathematics, Rajesh Kumar Thakur, Rupa Publications, New Delhi 2019.
2	Vedic Mathematics Made Easy, Dahaval Bathia, Jaico Publishing, New Delhi 2011
References Books	
(latest editions, and the style as given below must be strictly adhered to)	
1	Vedic Mathematics: Sixteen Simple Mathematical Formulae from the Vedas, Jagadguru Swami Sri Bharati Krishna Trithaji, Motilal Banarasidas, New Delhi 2015.

H.O.D.
DEPARTMENT OF MATHEMATICS,
PRIST DEEMED TO BE UNIVERSITY
THANJAVUR - 613 403

S. Sivarani

School of Arts & Sciences
Formalayah Ramajayam Institute of
Science & Technology (PRIST)
Deemed to be University
Vallam, Thanjavur - 613 403.

S. Sivarani

Course Code	22512LGLA	TITLE OF THE COURSE			
Value Added		LIE GROUPS & LIE ALGEBRAS			
Pre-requisite		Knowledge in basic algebra			
		L	T	P	C
		4	1	-	4
		Syllabus Version		2021-22	

Course Objectives

The main objectives of this course are to:

1. In physics, Lie groups appear as symmetry groups of physical systems, and their Lie algebras (tangent vectors near the identity) may be thought of as infinitesimal symmetry motions.
2. Lie algebras and their representations are used extensively in physics, notably in quantum mechanics and particle physics.

Expected Course Outcomes

On the successful completion of the course, student will be able to:

1	Understand the basics of R Language	K2
2	Apply the logical skills for performing statistical analysis	K4
3	Use appropriate plots, charts and diagrams for all kinds of data	K3
4	Perform parametric methods	K3
5	Write and execute the code for multivariate analysis	K6

K1 - Remember; K2 - Understand; K3 - Apply; K4 - Analyze; K5 - Evaluate; K6 -- Create

Unit:1	Matrix-Lie Groups
Unit:2	
Unit:3	The Matrix Exponential
Unit:4	Lie Algebras
Unit:5	Basic Representation Theory
	Semi-simple Lie Algebras
Books for Study	
1	Brain Hall, Lie Groups, Lie Algebras and Representations: An Elementary Introduction (Second Edition), Springer, USA, 2015.

Dr. Dignesh

[Signature]

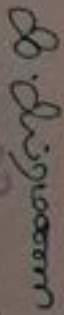
 DEPARTMENT OF MATHEMATICS
 KCOO,
 DEPARTMENT OF MATHEMATICS
 PRIST DEEMED TO BE UNIVERSITY
 THANJAVUR - 613 403

Reference Books	
1	V. S. Varadarajan, Lie groups, Lie algebras and their representations, Springer 1984.
2	A. W. Knap, Representation theory of semi-simple Lie groups. An overview based on examples, Princeton university press 2002.
3	S. Kumarasan S, A course in differential geometry and Lie groups, Texts and Readings in Mathematics, 22. Hindustan Book Agency, New Delhi, 2002.
1	Related Online Contents [MOOC, SWAYAM, NPTEL, Websites etc.]
1	

 School of Health & Science
 Ponnalyah Ramaswamy Institute of
 Science & Technology (PRIST)
 Dornale to the University
 Vellore, Thanjavur - 613 403



**PONNAIYAH RAMAJAYAN INSTITUTE OF
SCIENCE & TECHNOLOGY (PRIST)**

Declared as DEEMED - TO - BE - UNIVERSITY
U/s 3 of UGC Act, 1956
Vallam, Thanjavur - 613 403

Certificate Course
Value Addition Course

MATHEMATICAL SOFTWARE

Subject Code	Category	L	T	P	S	Credits	Inst. Hours	Marks		
								CIA	External	Total
23512VACMS	Value Added	4	1		2		25	75	100	

Learning Objectives

LO1	Knowledge in Fundamental computer programming concepts and some mathematical principles Course Out
LO2	To enable the students to have clear ideas about number concept.
LO3	To give the individual an understanding of ideas and operations in number and quantity needed in daily life
LO4	To provide opportunities that enable the learners to exercise and discipline mental faculties
LO5	To help the learner in the intelligent use of reasoning power

DETAILS

I	Core Language: Overview – Expressions – Rules & Patterns – Procedural Programming – Parallel Programming – Package Development – Syntax – Units – Lists – Variables & Functions – Functional Programming – String Manipulation – External Operations – Tuning & debugging
II	Mathematics and Algorithm Mathematical functions – Formula manipulation – Matrices & Linear Algebra – calculus – Polynomial Algebra – Graphs & Networks – Logic & Boolean Algebra – Control Systems – Mathematical Data – Number & Precision – Equation Solving – Optimization
III	Probability Statistics – Discrete Math – Number Theory – Computational Systems – Finance
IV	Visualization and Graphics Data visualization – Charting – Statistical visualization – Gauges – Drawing &

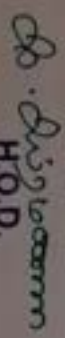

H.O.D.
 DEPARTMENT OF MATHEMATICS
 PRIST DEEMED TO BE UNIVERSITY
 THANJAVUR - 613 403

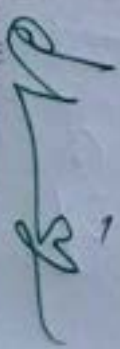
School of Arts & Science
 Ponnaiyah Ramajayan Institute of
 Science & Technology (PRIST)
 Deemed to be University
 Vallam, Thanjavur - 613 403.

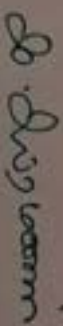

V	interactivity – computational Geometry – Sound & Sonification – Function visualization Dynamic visualization – Financial visualization – Options & Styling – Symbolic Graphics language – Importing & Exporting	
Course Outcomes		
CO1	Mathematical software can be used as a teaching tool in high school math classes to help students understand complex concepts. It can use interactive models and 2D/3D visualizations to make math topics more interesting	PO1
CO2	Mathematical software can improve students' achievement in geometry. It can also help close the gender gap in mathematics.	PO1,PO2
CO3	Mathematical software can be used to find new mathematical phenomena	PO4,PO6
CO4	Mathematical software can be used to prove theorems.	PO4,PO5, PO6
CO5	Mathematical software can be used to construct examples.	PO3,PO8

Text Books (latest Editions)		
1	Martha L. Abell, James P. Braselton, 2009, Mathematica by Example, 4th Edition, Academic Press, USA.	
2	Michael Trott, 2004, The Mathematica Guide Book for Programming, Springer, USA	
References Books		
(latest editions, and the style as given below must be strictly adhered to)		
1	Stephen Wolfram, 2003, The Mathematica Book, 5th Edition, Wolfram Media, USA	

H.O.D.
DEPARTMENT OF MATHEMATICS
PRIST DEEMED TO BE UNIVERSITY
THANJAVUR - 613 403

Deaen
School of Arts & Science
Ponnarajah Rattalavam Institute of
Science & Technology (PRIST)
Deemed to be University
Thamam, Thanjavur - 613 403.



**PONNAIYAH RAMAJAYAM INSTITUTE OF
SCIENCE & TECHNOLOGY (PRIST)**

Declared as DEEMED TO BE UNIVERSITY
U/s 3 of UGC Act, 1956

**SCHOOL OF ARTS AND SCIENCE
DEPARTMENT OF MATHEMATICS
ADD-ON COURSE
2023-2024
(Mathematics for Recruitment Examination-22512MIRE)**

Duration: 1 year

Type: Diploma

Students Attendance

Sl. No	Reg. No	Name	14	21	28	10	17	24	08	15	22	29	05	12	19	26	02	09	16	23	30	06	13	20	27	03	10	17	24	31	07	14	21	28	04	11	18	25	01	08	15	22	29												
1	2101MA10201	M. Divya	P	P	P	A	P	P	P	P	P	P	P	P	P	P	P	P	P	P	P	P	P	P	P	P	P	P	P	P	P	P	P	P	P	P	P	P	P	P	P	P	P	P	P	P	P	P							
2	2101MA10202	D. Iswarya	P	P	P	P	P	P	P	P	A	P	P	P	P	P	P	P	P	P	P	P	P	P	P	P	P	P	P	P	P	P	P	P	P	P	P	P	P	P	P	P	P	P	P	P	P	P	P	P	P				
3	2101MA10203	A. Nivashini	P	P	P	P	P	P	P	P	P	P	P	P	A	P	P	P	P	P	P	P	P	P	P	P	P	P	P	P	P	P	P	P	P	P	P	P	P	P	P	P	P	P	P	P	P	P	P	P	P	P			
4	2101MA10204	P. Padmapriya	P	P	P	P	P	P	P	P	P	P	P	P	P	P	P	P	P	P	P	P	P	P	P	P	P	P	P	P	P	P	P	P	P	P	P	P	P	P	P	P	P	P	P	P	P	P	P	P	P	P	P		
5	2101MA10205	S. Priyadharsini	P	P	P	P	P	P	P	P	P	P	P	P	P	P	P	P	P	P	P	P	P	P	P	P	P	P	P	P	P	P	P	P	P	P	P	P	P	P	P	P	P	P	P	P	P	P	P	P	P	P	P		
6	2101MA10206	A. Akila	P	P	P	P	P	P	P	P	P	P	P	P	P	P	P	P	P	P	P	P	P	P	P	P	P	P	P	P	P	P	P	P	P	P	P	P	P	P	P	P	P	P	P	P	P	P	P	P	P	P	P		
7	2101MA10207	M. Kalpana	P	P	P	P	P	P	P	P	P	P	P	P	P	P	P	P	P	P	P	P	P	P	P	P	P	P	P	P	P	P	P	P	P	P	P	P	P	P	P	P	P	P	P	P	P	P	P	P	P	P	P		
8	2101MA10208	M. Kalpana	P	P	P	P	P	P	P	P	P	P	P	P	P	P	P	P	P	P	P	P	P	P	P	P	P	P	P	P	P	P	P	P	P	P	P	P	P	P	P	P	P	P	P	P	P	P	P	P	P	P	P	P	
9	2101MA10209	S. Santhi	P	P	P	P	P	P	P	P	P	P	P	P	P	P	P	P	P	P	P	P	P	P	P	P	P	P	P	P	P	P	P	P	P	P	P	P	P	P	P	P	P	P	P	P	P	P	P	P	P	P	P	P	
10	2101MA10210	K. Srinivasnavi	P	P	P	P	P	P	P	P	P	P	P	P	P	P	P	P	P	P	P	P	P	P	P	P	P	P	P	P	P	P	P	P	P	P	P	P	P	P	P	P	P	P	P	P	P	P	P	P	P	P	P	P	P

Dean
Sr

S. Divyapriya
DEPARTMENT OF MATHEMATICS
PRIST DEEMED TO BE UNIVERSITY
THANJAVUR - 613 403

School of Arts & Science
Ponnaiyah Ramajayam Institute
of Science & Technology (PRIST)
Deemed to be University
Valliam, Thanjavur - 613 403



**PONNAIYAH RAMAJAYAM INSTITUTE OF
SCIENCE & TECHNOLOGY (PRIST)**

Declared as DEEMED TO BE UNIVERSITY
U/s 3 of UGC Act, 1956

**SCHOOL OF ARTS AND SCIENCE
DEPARTMENT OF MATHEMATICS**

**ADD-ON COURSE
2023-2024
(Diploma Course on MATLAB-21VADM1)**

Duration: 1 Year

TYPE: Diploma

Students attendance

Sl. No	Reg. No	Name	14	21	28	10	17	24	08	15	29	13	20	27	3	10	17	5	12	19	09	16	23	08	15	29	12	19	26	10	17	24	
1	2201MA201	H.Alagar	P	A	P	P	P	P	P	P	P	P	P	P	P	P	P	P	P	P	P	P	P	P	P	P	P	P	P	P	P	P	
2	2201MA201	S.Balasubram	P	P	P	A	P	P	P	P	P	P	P	P	P	P	P	P	P	P	A	P	P	P	P	P	P	P	P	P	P	P	
3	2201MA201	X.David	P	P	P	P	P	P	P	P	P	P	P	P	P	A	P	P	P	P	P	P	P	P	P	P	P	P	P	P	P	P	
4	2201MA201	V.S.Subraman	P	P	P	P	P	A	P	P	P	P	P	P	P	P	P	P	P	P	P	P	P	P	P	P	P	P	P	P	P	P	
5	2201MA201	K.Sridhar	P	P	P	P	P	P	P	P	P	A	P	P	P	P	P	P	P	P	P	P	P	P	P	P	P	P	P	P	P	P	
6	2201MA201	S.Thirunavukk	P	P	P	P	P	P	P	P	P	P	P	P	A	P	P	P	P	P	P	P	P	P	P	P	P	P	P	P	P	P	
7	2201MA201	P.Thiru	P	P	A	P	P	P	P	P	P	P	P	P	P	P	A	P	P	P	P	P	P	P	P	P	P	P	P	P	P	P	
8	2201MA201	O.Thilagareth	P	P	P	P	P	P	P	P	P	P	P	P	P	P	P	P	P	P	A	P	P	P	P	P	P	P	P	P	P	P	P
9	2201MA201	S.Veerarajan	P	P	P	P	P	P	P	P	P	A	P	P	P	P	P	P	P	P	P	P	P	P	P	P	P	P	P	P	P	P	P

S. Sivasubramanian
DEPARTMENT OF MATHEMATICS
PRIST DEEMED TO BE UNIVERSITY
THANJAVUR - 613 403

School of Arts & Science
Ponnaiyah Ramajayam Institute of
Science & Technology (PRIST)
Deemed to be University
Valliam, Thanjavur - 613 403.



**PONNAIYAH RAMAJAYAM INSTITUTE OF
SCIENCE & TECHNOLOGY (PRIST)**

Declared as DEEMED-TO-BE-UNIVERSITY
U/s 3 of UGC Act, 1956

**SCHOOL OF ARTS AND SCIENCE
DEPARTMENT OF MATHEMATICS
ADD-ON COURSE**

2023-2024

**Duration: 6 MONTHS
(Certificate Course on VEDIC MATHEMATICS – I -23512VACVM1)**

TYPE: CERTIFICATE

Students attendance

Sl.No.	Reg. No	Name	16-7-23	21-7-23	26-7-23	10-08-23	17-08-23	24-08-23	08-09-23	15-09-23	29-09-23	13-10-23	20-10-23	27-10-23	3-11-23	20-11-23	17-11-23
1	2301MA10101	D.Satheskumar	A	P	P	P	P	P	P	P	P	P	P	P	P	P	P
2	2301MA10102	M.Sownterrajan	P	P	A	P	P	P	P	P	P	P	P	P	P	P	P
3	2301MA10103	L.Sriram	P	P	P	P	P	P	P	P	P	P	P	P	P	P	P
4	2301MA10104	K.Vilayavanthan	P	P	P	P	P	P	P	P	P	P	P	P	P	P	P
5	2301MA10105	M.Shammugam	P	P	P	P	P	P	P	P	P	P	P	P	P	P	P
6	2301MA10201	K.Nithya	P	P	P	P	P	P	P	P	P	P	P	P	P	P	P
7	2301MA10202	V.Sindhu	P	P	P	A	P	P	P	P	P	P	P	P	P	P	P
8	2301MA10106	S.Mathivanan	P	P	P	P	P	P	P	P	P	P	P	P	P	P	P
9	2301MA10203	I.Niwasraja	P	P	P	P	P	P	P	P	P	P	P	P	P	P	P
10	2301MA10204	S.Preethi	P	P	P	P	P	P	A	P	P	P	P	P	P	P	P
11	2301MA10205	B.Dhanalaximi	P	P	P	P	P	P	P	P	A	P	P	P	P	P	P
12	2301MA10107	M.Muneeswaran	P	P	P	P	P	P	P	P	P	P	P	P	P	P	P

B. Digilegan

DEPARTMENT OF MATHEMATICS
PRIST DEEMED-TO-BE-UNIVERSITY
THANJAVUR - 613 403

44

Dean

School of Arts & Science
Ponnaiyah Ramajayam Institute of
Science & Technology (PRIST)
Deemed to be University
Vallam, Thanjavur - 613

42	2301MA10230	D.Venilla	A	P	P	P	P	P	P	P	P	P	P	P	P	P	P	P	P	P	P
43	2301MA10231	S.Bhuvaneshwari	P	P	P	P	P	P	P	P	P	P	P	P	P	P	P	P	P	P	P
44	2301MA10114	A.Dinesh Kumar	P	P	P	P	P	P	P	P	P	P	P	P	P	P	P	P	P	P	P
45	2301MA10115	S.Dineshkumar	P	P	P	P	P	P	P	P	P	P	P	P	P	P	P	P	P	P	P
46	2301MA10232	L.Thamilzamani	P	P	P	P	P	P	P	P	P	P	P	P	P	P	P	P	P	P	P

D. Dinesh Kumar
 H.O.D,
 DEPARTMENT OF MATHEMATICS
 PRIST DEEMED TO BE UNIVERSITY
 THIRUVANANTHAPURAM - 611 303

46

Dean
 School of Arts & Science
 Ponnalyak Ramrajaram Institute of
 Science & Technology (PRIST)
 Dattinagar, Tiruvananthapuram
 Vailom, Thiruvananthapuram - 611 303





**PONNAIYAH RAMAJAYAN INSTITUTE OF
SCIENCE & TECHNOLOGY (PRIST)**

Declared as DEEMED TO BE UNIVERSITY
U/s 3 of UGC Act, 1956

**SCHOOL OF ARTS AND SCIENCE
DEPARTMENT OF MATHEMATICS
ADD-ON COURSE**

2023-2024

(LIE GROUPS & LIE ALGEBRAS-22512LGLA)

Duration: 6 Months

Type: Certificate

Students Attendance

Sl.No	Reg. No	Name	14-7-23	21-7-23	28-7-23	30-08-23	31-08-23	24-08-23	08-09-23	15-09-23	29-09-23	13-10-23	20-10-23	27-10-23	3-11-23	10-11-23	17-11-23
1.	2201MA10201	A.Ablisheka	A	P	P	P	P	P	P	P	P	P	P	P	P	P	P
2.	2201MA10202	K.Ambiga Selvi	P	P	P	P	P	P	P	P	P	P	P	P	P	P	P
3.	2201MA10203	L.Anbu Selvi	P	P	A	P	P	P	P	P	P	P	P	P	P	P	P
4.	2201MA10204	V.Bhagyalakshmi	P	P	P	A	P	P	P	P	P	P	P	P	P	P	P
5.	2201MA10205	S.Bhavani	P	P	P	P	P	P	P	P	P	P	P	P	P	P	P
6.	2201MA10206	K.Chitra	P	P	P	P	P	P	P	P	P	P	P	P	P	P	P
7.	2201MA10207	J.Devishree	P	P	P	P	P	A	P	P	P	P	P	P	P	P	P
8.	2201MA10208	T.Esther	P	P	P	P	P	P	P	P	P	P	P	P	P	P	P
9.	2201MA10209	A.Fathima	P	P	P	P	P	P	P	P	P	P	P	P	P	P	P
10.	2201MA10210	R.Gunavathi	P	P	P	P	P	P	P	P	P	P	P	P	P	P	P
11.	2201MA10211	J.Ilamathi	P	P	A	P	P	P	P	P	P	P	P	P	P	P	P
12.	2201MA10212	U.Kavitha	P	P	P	P	P	P	P	P	P	P	P	P	P	P	P
13.	2201MA10213	T.Latha	P	P	P	P	P	P	P	P	P	P	P	P	P	P	P

S.H.D. Perera
DEPARTMENT OF MATHEMATICS
PRIST DEEMED TO BE UNIVERSITY
THANJAVUR - 613 403

School of Arts & Science,
Ponnaiyah Ramajayan Institute of
Science & Technology (PRIST)
Deemed to be University
Velliam, Thanjavur - 613 403.

14.	2201MA10214	E.Meenakumari	A	P	P	P	P	P	P	P	P	P	P	P	P	P	P	P	P	P	P	P
15.	2201MA10215	O.Nilavu	P	P	P	P	P	P	P	P	P	P	P	P	P	P	P	P	P	P	P	P
16.	2201MA10216	S.Prakshna	P	P	A	P	P	P	P	P	P	P	P	P	P	P	P	P	P	P	P	P
17.	2201MA10217	B.Revathi Kannan	P	P	P	P	P	P	P	A	P	P	P	P	P	P	P	P	P	P	P	P
18.	2201MA10218	N.Subarna	P	P	P	P	P	P	A	P	P	P	P	P	P	P	P	P	P	P	P	P
19.	2201MA10219	D.Subbulakshmi	P	P	P	P	P	P	P	P	P	P	P	P	P	P	P	P	P	P	P	P
20.	2201MA10220	H.Thilakavathi	P	P	P	P	P	P	P	P	A	P	P	P	P	P	P	P	P	A	P	P
21.	2201MA10221	K.Thiruseivi	P	P	P	P	P	P	P	P	P	P	P	P	P	P	P	P	P	P	P	P
22.	2201MA10222	L.Thanalakshmi	P	P	P	P	P	P	P	P	P	P	P	P	P	P	P	P	P	P	P	P
23.	2201MA10223	T.Tamilarasi	P	P	P	A	P	P	P	P	P	P	P	P	P	P	P	P	P	P	P	P
24.	2201MA10224	S.Vaishnavi	P	P	P	P	P	P	P	P	A	P	P	P	P	P	P	P	P	P	P	P
25.	2201MA10225	V.Veerakumari	P	P	P	P	P	P	P	P	P	P	P	P	P	P	P	P	P	P	P	P
26.	2201MA10101	A.Abishek	P	P	P	P	P	P	P	P	P	P	P	P	P	P	P	P	P	P	P	P
27.	2201MA10102	S.Arumbiga Vignesh	P	P	P	P	P	P	P	P	A	P	P	P	P	P	P	P	P	P	P	P
28.	2201MA10103	J.Alagirisamy	P	P	P	P	P	P	P	P	P	P	P	P	P	P	P	P	P	P	P	P
29.	2201MA10104	K.Balasubramanian	P	P	P	P	P	P	A	P	P	P	P	P	P	P	P	P	P	P	P	P
30.	2201MA10105	M.Balakumar	P	P	P	P	P	P	P	P	P	P	P	P	P	P	P	P	P	P	P	P
31.	2201MA10106	N.Balakrishnan	P	P	P	P	P	P	P	P	P	P	P	P	P	P	P	P	P	P	P	P
32.	2201MA10107	S.Dharun	P	P	P	P	P	P	P	P	P	P	P	P	P	P	P	P	P	A	P	P
33.	2201MA10108	V.Dharun Kumar	P	P	P	P	P	P	P	P	P	P	P	P	P	P	P	P	P	P	P	P
34.	2201MA10109	H.Gunasekaran	P	P	P	P	P	P	P	A	P	P	P	P	P	P	P	P	P	P	P	P
35.	2201MA10110	I.Guhan	P	P	P	P	P	P	P	P	P	P	P	P	P	P	P	P	P	P	P	P
36.	2201MA10111	A.Har Krishnan	P	P	A	P	P	P	P	P	P	P	P	P	P	P	P	P	P	P	P	P
37.	2201MA10112	P.Harharan	P	P	P	P	P	P	P	P	P	P	P	P	P	P	P	P	P	P	P	P
38.	2201MA10113	Y.Janakrman	P	P	P	P	P	P	P	P	P	P	P	P	P	P	P	P	P	P	P	P
39.	2201MA10114	W.Joshuva	P	P	P	P	P	P	P	P	P	P	P	P	P	P	P	P	P	P	P	P
40.	2201MA10115	G.Kumaran	P	P	P	P	P	P	P	P	P	P	P	P	P	P	P	P	P	P	P	P
41.	2201MA10116	V.Kumarasamy	P	P	P	P	P	P	P	P	P	P	P	P	P	P	P	P	P	P	P	P
42.	2201MA10117	M.Lalith Selvan	P	P	P	P	P	P	P	P	P	P	P	P	P	P	P	P	P	P	P	P

A.B.S.

DEPARTMENT OF MATHEMATICS
PRIST DEEMED TO BE UNIVERSITY
THANJAVUR - 613 403

School of Arts & Science
Ponnambah Ramajayam Institute of
Science & Technology (PRIST)
Deemed to be Univer
Thanjavur - 6

Dean

43.	2201MA10118	R.Manoj Kumar	A	P	P	P	P	P	P	P	P	P	P	P	P	P	P	P	P	P
44.	2201MA10119	T.Meenatchi	P	P	P	P	P	P	P	P	P	P	P	P	P	P	P	P	P	P
45.	2201MA10120	M.Maharajan	P	P	P	P	P	P	P	P	P	P	P	P	P	P	P	P	P	P
46.	2201MA10121	C.Neelakandan	P	P	P	P	P	P	P	P	A	P	P	P	P	P	P	P	P	P
47.	2201MA10122	R.Neeraj Kumar	P	P	P	P	P	P	P	P	P	P	P	P	P	P	P	P	P	P
48.	2201MA10123	P.Paul Pandian	P	P	P	P	P	P	P	P	P	P	P	P	P	P	P	P	P	P
49.	2201MA10124	S.Sundaram	P	P	P	P	P	P	P	P	P	P	P	P	P	P	P	P	P	P

H.O.D.
DEPARTMENT OF MATHEMATICS
PRIST DEEMED TO BE UNIVERSITY
THANJAVUR - 613 403

S. Sivasubramanian

Dean
School of Arts & Science
Ponnalyah Ramalayam Institute of
Science & Technology (PRIST)
Daerapalayam, Thanjavur University
Vandavasi, Thanjavur

S. Sivasubramanian



**PONNAIYAH RAMAJAYAM INSTITUTE OF
SCIENCE & TECHNOLOGY (PRIST)**

Declared as DEEMED TO BE UNIVERSITY
U/e 3 of UGC Act 1956

**SCHOOL OF ARTS AND SCIENCE
DEPARTMENT OF MATHEMATICS
ADD-ON COURSE
2023-2024
(MATHEMATICAL SOFTWARE-23512VACMS)**

Duration: 6 Months

Type: Certificate

Students Attendance

Sl.No	Reg. No	Name	14-7-23	21-7-23	28-7-23	10-08-23	17-08-23	24-08-23	08-09-23	15-09-23	22-09-23	11-10-23	20-10-23	27-10-23	3-11-23	10-11-23	17-11-23
1	2301MA20201	M.Varshaa	A	P	P	P	P	P	P	P	P	P	P	P	P	P	P
2	2301MA20202	D.Abirami	P	P	A	P	P	P	P	P	P	P	P	P	P	P	P
3	2301MA20203	M.Priyadarshini	P	P	P	P	A	P	P	P	P	P	P	P	P	P	P
4	2301MA20204	K.Jeevithaa	P	P	P	P	P	P	P	P	P	P	P	P	P	P	P
5	2301MA20205	Anusha.I	P	P	P	P	P	A	P	P	P	P	P	P	P	P	P
6	2301MA20101	Kumaran.S	P	P	P	P	P	P	P	A	P	P	P	P	P	P	P
7	2301MA20102	Kittu.M	P	P	P	P	P	P	P	P	P	P	P	P	P	P	P
8	2301MA20103	Venkatesh.V	P	P	P	P	P	P	P	P	P	P	P	P	P	P	P
9	2301MA20104	Prakash.B	P	P	A	P	P	P	P	P	P	P	P	P	P	P	P
10	2301MA20105	Marimuthu.F	P	P	P	P	P	P	P	P	P	P	P	P	P	P	P
11	2301MA20106	Rajkumar.L	P	P	P	P	P	P	P	P	A	P	P	P	P	P	P
12	2301MA20107	Kannan.L	P	P	P	P	P	P	P	P	P	P	P	P	P	P	P
13	2301MA20108	Shankar.P	P	P	P	P	P	P	A	P	P	P	P	P	P	P	P

[Signature]
H.O.D.

DEPARTMENT OF MATHEMATICS
PRIST DEEMED TO BE UNIVERSITY
THANJAVUR - 613 403

Dean
[Signature]
School of Arts & Sciences
Ponnaiyah Ramajayam Institute of
Science & Technology (PRIST)
Deemed to be University,
Thanjavur - 613 403.

14	2301MA20109	Felica Y	A	P	P	P	P	P	P	P	P	P	P	P	P	P	P	P	P	P	P	P
15	2301MA20110	Felica Raj,S	P	P	P	D	P	P	P	P	P	P	P	P	P	P	P	P	P	P	P	P
16	2301MA20206	Manjula,V	P	P	P	A	P	P	P	P	P	P	P	P	P	P	P	P	P	P	P	P
17	2301MA20207	Manjula,F	P	P	P	P	P	P	A	P	P	P	P	P	P	P	P	P	P	P	P	P
18	2301MA20110	Suresh kumar ,R	P	P	P	P	P	P	P	P	P	P	P	P	P	P	P	P	P	P	P	P
19	2301MA20208	Saranya sri ,K	P	P	P	P	P	P	P	P	P	P	P	P	P	P	P	P	P	P	P	P
20	2301MA20209	Backia ,K	P	P	P	P	P	P	P	P	A	P	P	P	P	P	P	P	P	P	P	P
21	2301MA20111	Selvam ,S	P	P	P	P	P	P	P	P	P	P	P	P	P	P	P	P	P	P	P	P
22	2301MA20112	Cholan ,T	P	P	P	P	P	P	P	P	P	P	P	P	P	P	P	P	P	P	P	P

Dr. Digvijay

H.O.D.

DEPARTMENT OF MATHEMATICS
PRIST DEEMED TO BE UNIVERSITY
THANJAVUR - 613 403

Dr. Sm

Dean

School of Arts & Science
Ponnalyeh Ramajayam Institute
Science & Technology (PRIST)
Pondicherry University
Thanjavur - 613 403



PRIST

DEEMED TO BE UNIVERSITY

SCHOOL OF ARTS AND SCIENCE

Certificate of Appreciation

This is to certify that

Ms/Mr K.PUSHPA (2101MA10231)

has completed the Value Added Course on

MATHEMATICS FOR RECRUITMENT EXAMINATION

from 14.07.23-24.05.24 during the Academic year of

2023 - 2024

S. Jith
Course
coordinator

S. Srinivasan
HOD

S. Srinivasan
DEAN

H.O.D.

Dean

DEPARTMENT OF MATHEMATICS
PRIST ENGINEERING TO BE UNIVERSITY
THANJAVUR - 613 403

School of Arts & Science
Ponnysish Engineering Institute of
Science & Technology (PRIST)
Deemed to be University
Villupuram, Thanjavur
613 403



PRIST
DEEMED TO BE UNIVERSITY
SCHOOL OF ARTS AND SCIENCE



Certificate of Appreciation

This is to certify that

Ms/Mr **S. VIJAYA** (2201MA201110)

has completed the Value Added Course on

MATLAB

from 14.07.23-24.05.24 during the Academic year of

2023 - 2024

S. Sridhar
course
coordinator

S. Sridhar

HOD

H.O.D.

DEPARTMENT OF MATHEMATICS
PRIST DEEMED TO BE UNIVERSITY
THANJAVUR - 613 403

DEANⁿ

[Signature]

School of Arts & Science
Ponnaiyah Ramalayah Institute of
Science & Technology (PRIST)
Deemed to be University
Vellam, Thanjavur - 613 403.



PRIST

DEEMED TO BE UNIVERSITY
SCHOOL OF ARTS AND SCIENCE

Certificate of Appreciation

This is to certify that

Ms/Mr S.REKA (2301MA10223)

has completed the Value Added Course on

VEDIC MATHEMATICS - I

from 14.07.23-24.11.23 during the Academic year of

2023 - 2024

[Signature]
course
coordinator

HOD

[Signature]

DEAN

[Signature]

DEPARTMENT OF MATHEMATICS
PRIST-047
TRIVANMIPUR - 689 403

School of Arts & Science
Ponnalyah Ramajayam Institute of
Science & Technology (PRIST)
Deemed to be University
Trivandrum - 689 403



P.R.I.S.T
 DEEMED TO BE UNIVERSITY
 SCHOOL OF ARTS AND SCIENCE



Certificate of Appreciation

This is to certify that

Ms/Mr **S.SUNDARAM** (2201MA10124)

has completed the Value Added Course on

LIE GROUPS & LIE ALGEBRA

from 14.07.23-17.11.23 during the Academic year of

2023 - 2024

[Signature]
 Course
 coordinator

[Signature]

H.O.P.

DEPARTMENT OF MATHEMATICS,
 PRIST DEEMED TO BE UNIVERSITY
 THANJAVUR - 613 403

DEAN

[Signature]

School of Arts & Science
 Periyar Educational Institute of
 Science & Technology (PRIST)
 Deemed to be University
 Villam, Thanjavur - 613



PRIST
DEEMED TO BE UNIVERSITY
SCHOOL OF ARTS AND SCIENCE

Certificate of Appreciation

This is to certify that

Ms/Mr **M. Varsha (2301MA20201)**

has completed the Value Added Course on

MATHEMATICAL SOFTWARE

from 14.07.23-17.11.23 during the Academic year of

2023 - 2024

[Signature]
Course
coordinator

[Signature]

HOD.

DEPARTMENT OF MATHEMATICS
PRIST DEEMED TO BE UNIVERSITY
THANJAVUR - 613 403

DEAN

[Signature]

School of Arts & Science
Ponnalyah Ramajayam Institute
of Science & Technology (PRIST)
Deemed to be University
Veerampalayam, Thanjavur - 613 403.





PONNAIYAH RAMAJAYAM INSTITUTE OF SCIENCE & TECHNOLOGY (PRIST)

Declared as DEEMED-TO-BE-UNIVERSITY
U/s 3 of UGC Act, 1956

PRIST/A&S/BC/23-24/54

28.06.2023

SCHOOL OF ARTS AND SCIENCE

DEPARTMENT OF BIOCHEMISTRY

This is to inform to all students that the value-added programmes classes for academic year 2021-2022 semester I, III, V will be commenced from 10.07.2023. Hence requesting all the registered students to attend the classes without fail.

Branch Name	Year	Course Offered
B.Sc., Biochemistry	2023-2024	Diploma Course in organic farming

HOD

Head of the Department
Department of Biochemistry
School of Arts & Science
PRIST Deemed to be University
Thanjavur-613 403

DEAN

DEAN
School of Arts & Science
Ponnaiyah Ramajayam Institute of
Science & Technology (PRIST)
Deemed to be University
Vellam, Thanjavur - 613 403.



PONNAIYAH RAMAJAYAM INSTITUTE OF SCIENCE & TECHNOLOGY (PRIST)

Declared as DEEMED-TO-BE-UNIVERSITY
U/s 3 of UGC Act, 1956

DIPLAMA IN ORGANIC FARMING -17515OF

Aim:

To acquaint students with philosophy, objectives and principles of organic agriculture.

Course objective:

- To impart knowledge and proficiency in Organic production practices, Certification process and Marketing of organically raised agriculture products.
- To promote self-employment and income generation

Course Outcome:

- Understand the concept and the importance of organic farming
- Distinguish the different streams of Agriculture.
- Maintain and preserve existing ecosystems and promote the maintenance of the balance of the recommended farming system.
- Have relevant knowledge of agricultural technology for the fertilization of the land mobilization and composting.
- Have relevant knowledge of agricultural technology for composting methods in organic farming.
- Know legislation rules on livestock in OF.

Unit: I- Introduction: Farming, organic farming, concept and development of organic farming. Principles of organic farming & Need for organic farming, Agencies and institutions related to organic agriculture.

Unit: II-Organic farming systems, Soil tillage, Choice of Varieties, crop notation multiple and cropping systems, intercropping in relation to maintained of soil productivity by Propagation-seed, planting materials.

Unit:III- Plant protection- cultural, Plant protection - mechanical . Plant protection- botanical pesticides I, Plant protection- botanical pesticides II, Plant protection- botanical pesticides III. Plant protection- biopesticide. Plant protection- biocontrol agents, Plant protection- biocontrol agents.

Unit:IV-Organic crop production methods- rice, coconut, cashew, vegetables. Livestock component in organic farming, Livestock Management in organic farming.

Unit:V- Farm economy: Basic concept of economics- Demand, supply, Economic Viability of a farm. Basic production principles, reducing expenses, ways to increase returns.

REFERENCE:

1. Organic Farming : Theory and Practice - S.P.Palaniappan and K.Aannadurai
2. A Hand book of Organic Farming - A.K. Sharma
3. Hand book of Organic Farming and Biofertilizers - A.C.Gaur
4. Organic farming for sustainable Horticulture – P. Parvatha Reddy
5. Organic Agriculture – J.C. Tarafdar

Head of the Department
Department of Biochemistry
School of Arts & Science
PRIST Deemed to be University
Thanjavur-613 403

DEAN
School of Arts & Science
Ponnaiyah Ramajayam Institute of
Science & Technology (PRIST)
Deemed to be University
Vellam, Thanjavur - 613 403.

APPLICATION FORM

1. Full Name
 2. Programme
 3. Discipline
 4. Institution Name
 5. Date of Birth
 6. Sex (M/F)
 7. E. mail
 8. Mobile No.
 9. Parents
- Address

Signature of the Applicant

Submission of Application Form

Submit your Application Form in person to the co-ordinator, School of Arts and Science, PRIST University, Thanjavur, Vallam, 613 403.

Application may be sent to

Course Co-Ordinator

Prof.R.Vinayalagan

Assistant Professor

Department of Biochemistry

ABOUT THE UNIVERSITY

PRIST University, Ponnaiyah Ramajayam Institutions, made a foray into the Academic Domain, with the establishment of Sri Ram Institute of Computer Science and Technology in 1985. Over time, various institutions of higher learning such as Arts and Science College, College of Engineering and Technology, College of Education, Research Institution, Polytechnic College are added feathers to the PRIST crown. Today, PRIST commands a massive student base, spread across a whole array of campuses such as Pudukottai, Trichy, Kumbakonam, Chennai and Madurai. The Academic research extends right from school education up to the level of the Ph.D. Doctoral programmes in a rich array of disciplines such as Medicine, Engineering, Arts & Science, education, Pharmacy, Management and Technology etc.

FACILITIES AVAILABLE

The University is housed in an independent, multi storey building with state of art equipment, excellent Laboratories and infrastructure to help complete this course. Majority of the research have been going on monitoring the research program. Computer Library with internet facilities for students, Hostel facilities, Health centre, Sports complex, etc...

DEPARTMENT OF BIOCHEMISTRY

Life science course is very broad where one get to touch and know about all the major areas of life (biological) sciences.

The Biochemistry is focusing on some major areas like genetics, biochemistry, cell biology, molecular biology. So this course can provide much firmer lead on fermented production.



PONNAIYAH RAMAJAYAM INSTITUTE OF SCIENCE & TECHNOLOGY (PRIST)

Deemed as DEEMED TO BE UNIVERSITY
 Div 3 of UGC Act, 1956

ADD-ON COURSES, B.Sc., PROGRAMME DIPLOMA COURSE ORGANIC FARMING 2023-2024



PONNAIYAH RAMAJAYAM INSTITUTE OF SCIENCE & TECHNOLOGY (PRIST)

U.S 3 of UGC Act, 1956

Thanjavur - 613 403, Tamil Nadu

SCHOOL OF ARTS AND SCIENCE,
 DEPARTMENT OF BIOCHEMISTRY,
 VALLAM, THANJAVUR - 613 403

ABOUT FACULTY OF BIOCHEMISTRY

The department of Life Science was established in the year 2006, with Biototechnology, Biochemistry and Microbiology. Department focuses on research and education different courses like M.Phil, M.Sc, M.Tech, M.A, M.Ed and Ph.D programs offered. In this department there are 10 faculty members (Professor, Associate and Assistant Professor) and they having Post-Doctoral Research experience from Israel, Malaysia, China, Korea and South Africa. The areas of research of the department Molecular diagnostics, Stem Biotechnology, Metabolic Engineering, Biochemistry, Biotechnology, Agro medical technologies. The department has published quality research paper in leading scientific publishers such as Thovier, Springer, RSC, etc.

COURSE OBJECTIVE

This course is planned to give adequate knowledge on Organic Farming to train the students for self-employment.

COURSE DURATION (90 Hrs.)

COURSE CONTENT (Module 1)

- Organic farming
- Organic agriculture

COURSE CONTENT (Module 2)

- Organic farming system
- Choice of varieties

COURSE CONTENT (Module 2)

- Plant production
- Biological agents

COURSE CONTENT (Module 4)

- Organic crop production methods

Management in organic farming

COURSE CONTENT (Module 5)

- Farm economy
- Economic Viability of a farm

EXAMINATION

They shall be an annual university examination at the end of academic years.

Eligibility criteria for appearing in the in the final examination

- Minimum Attendance - 80%
- Minimum Internal Assessment marks - 40%
- It will be done through the whole year.
- Candidate must obtain at least 35% marks in theory and practical separately in internal
- Assessment to be eligible for the annual university examination.
- Internal assessment (Theory) will be done as follows:
- a) Mid-term and term examinations = 10 marks
- b) Assignments, Projects/Case - test/Clinical Presentations = 05 marks
- c) Attendance = 05 marks
- Total = 20 marks

Criteria for a pass in the subject

- Minimum marks in theory - 40
- Scheme of Examination:-
- Duration of written examination - 1 hr.
- Examination marks - 100

Course Program Objective

Students enrolled for the diploma course in Organic Farming product will following the objectives. Students will demonstrate knowledge of scientific principles related to agriculture.

- Understand what it takes to start and successfully operate a farm or educational project
- Use information from the course and other sources to make farm management decisions
- The ability to speak clearly about farm management, agriculture, food systems, small business management and your farm goals

Eligibility criteria

Any graduate shall be eligible for the examination in the course Intake Capacity 15 Seats on first come first basis (Additional admissions in the course is prerogative of the school)

Course Structure and Duration

Course is 12 month duration and will be of 30 hrs imparted training programme covering theoretical and practical aspects of fermentation technology.

Certification

The candidates successfully completing the course the course shall be awarded a certificate in that effect by the appropriate form by School of Arts and Science, Department of Biochemistry, PRIST University, Thanjavur, Vallam.

[Handwritten Signature]

Head of the Department
 Department of Biochemistry
 School of Arts & Science
 PRIST Deemed to be University
 Thanjavur-613 403

[Handwritten Signature]

DEAN
 School of Arts & Science
 Ponnaiyah Ramajayam Instn.
 Science & Technology (PRIST)
 Deemed to be University
 Vallam, Thanjavur - 613 403.



PONNAIYAH RAMAJAYAM INSTITUTE OF SCIENCE & TECHNOLOGY (PRIST)

Declared as DEEMED-TO-BE-UNIVERSITY
U/s 3 of UGC Act, 1956

PRIST/A&S/BC/23-24/54

28.07.2023

SCHOOL OF ARTS AND SCIENCE

DEPARTMENT OF BIOCHEMISTRY

This is to inform to all students that the value-added programmes classes for academic year 2021-2022 semester I, III, V will be commenced from 10.08.2023. Hence requesting all the registered students to attend the classes without fail.

Branch Name	Year	Course Offered
B.Sc., Biochemistry	2023-2024	Certificate course on Techniques in Biochemistry

HOD

Head of the Department
Department of Biochemistry
School of Arts & Science
PRIST Deemed to be University
Thanjavur-613 403

DEAN

DEAN
School of Arts & Science
Ponnaiyah Ramajayam Institute of
Science & Technology (PRIST)
Deemed to be University
Thanjavur - 613 403



PONNAIYAH RAMAJAYAM INSTITUTE OF SCIENCE & TECHNOLOGY (PRIST)

Declared as DEEMED-TO-BE-UNIVERSITY
U/s 3 of UGC Act, 1956

Value added course- (23-24) Certificate course on Techniques in Biochemistry 22515TB (45 Hours)-Syllabus

AIM- Developing analytical skills: Students should develop analytical, technical, and critical thinking skills.

COURSE OBJECTIVES

- Understanding biochemical processes: Students should gain a solid foundation in biochemical processes.
- Developing analytical skills: Students should develop analytical, technical, and critical thinking skills.
- Becoming scientifically literate: Students should become scientifically literate so they can contribute to the field after graduation.
- Learning about biological phenomena: Students should learn about the chemistry of biological phenomena in living organisms.

Unit:1

Basic Instruments and techniques: Working principles, basic operation and application of Microtome, weighing balance, PH meter, autoclave, Oven, laminar air flow, Water Baths, CO₂ Incubators, Shaking Incubators, Hot Air Ovens, Bio-Safety Hoods, Fume Hoods, Pipettes and MiliQ water system. Principle of asepsis and sterilization technique.

Unit:2

Microscopy and its modifications – Working principles, basic operation and application of Light, phase contrast and interference, Fluorescence, Confocal, Electron (TEM and SEM)

Centrifugation: Working principles, basic operation and application of micro-centrifuge, ultracentrifuge and density gradient centrifugation, applications (isolation of cell components), determination of molecular weight by sedimentation velocity and sedimentation equilibrium methods

Unit:3

Electrophoretic and PCR techniques: Working principles, basic operation and application of agarose, polyacrylamide and SDS-polyacrylamide gel electrophoresis, capillary electrophoresis, 2-D electrophoresis, pulsed field gel electrophoresis. Working principles, basic operation and application of Gradient PCR, RT-PCR and Gel Documentation system.

Unit:4

Chromatography techniques: Working principles, basic operation and application of TLC, gel permeation, ion exchange and affinity chromatography, HPLC. Spectroscopy technique: Working principles, basic operation and application of UV visible spectroscopy, fluorescence, NMR, ESR, plasma emission spectroscopy, Atomic Absorption Spectroscopy, GC-MS, LC-MS, FTIR and X-ray crystallography

Unit:5

Calibration, Validation, and certification of instruments like PCR's, Ovens, Incubators, Volumetric Dispensers, Spectrophotometers, and Electronic Balances etc. using International Standards.

Documentation for Instrumentation systems and procurement procedures, design of typical laboratory, safety measurement and IPR's.

REFERENCES

- Freifelder D., Physical Biochemistry, Application to Biochemistry and Molecular Biology, W.H. Freeman and Company, San Francisco.
- Wilson, K. and Walker, J. Principles and Techniques of Practical Biochemistry Cambridge University Press.
- Holmeand, D. and Peck, H. Analytical Biochemistry. Longman
Scopes, R. Protein Purification - Principles and Practices. Springer Verlag.
Pattabhi V and Gautham N. Biophysics, Kluwer Academic Publishers.
- Narayanan P. Essentials of Biophysics, New Age International Pvt Ltd.
Volkenshtein, M.V. General Biophysics Academic Press, Inc.
- Daniel, M. Basic Biophysics for biologists Agrobios.
Van, Holde, Johnson, K. E., Cutis, W. and Shing Ho, P. Principles of physical biochemistry, Pearson education Pvt. Ltd.



Head of the Department
Department of Biochemistry
School of Arts & Science
PRIST Deemed to be University
Thanjavur-613 403



DEAN
School of Arts & Science
Ponnalyah Ramajayam Inst.
Science & Technology (P
Deemed to be University
Vallam, Thanjavur - 613 403.

APPLICATION FORM

1. Full Name
2. Programme
3. Discipline
4. Institution Name
5. Date of Birth
6. Sex (M/F)
7. E-mail
8. Mobile No.
9. Parents' Address

Signature of the Applicant

Submission of Application Form

Submit your Application form in person to the coordinator, School of Arts and Science, PRIST University, Thanjavur, Villam, 613 403.

Application may be sent to

Course Coordinator
Dr. M. Subramanian
Assistant Professor
Department of Biochemistry
PRIST University

About the University

Ponnaiyah Ramajayam Institute of Science and Technology (PRIST) is a deemed university in Villam, India. The Institute offers undergraduate and postgraduate courses in Engineering, Science, Education, Management, Arts, and Law, as well as research programmes.

Facilities Available

The University is located in an independent, modern stone building with state of art equipment, excellent Laboratories and infrastructure to help complete this course. Majority of students have been doing an internship in the research process. Computer Library with internet facilities for students, Hostel facilities, Health centre, Sports complex, etc.

Department of Biochemistry

LIFE science course is very broad, where one get to study and learn about all the major areas of life (biological) sciences.

The Biochemistry is focusing on water stage areas like genetics, biochemistry, cell biology, molecular biology. In this course you provide much focus lead in Bio-fertilizer production.



PONNAYAH RAMAJAYAM INSTITUTE OF SCIENCE & TECHNOLOGY (PRIST)

Deemed as DEEMED TO BE UNIVERSITY
Act 3 of 2002 Act, 1958

CERTIFICATE COURSE ON TECHNIQUES IN BIOCHEMISTRY 2023-2024



COURSE OBJECTIVE

- To introduce concepts of vermicomposting.
- To understand techniques in Vermicomposting.
- To increase employability of the students.
- To improve the soil quality by promoting the biofertilizers.
- To educate about role of Earthworm
- To learn the importance of Earthworms and help to maintain a good soil structure.
- To educate about Recycling of water through vermicomposting

COURSE CONTENT (Module 1)

Classification earthworms
Anatomy of earthworms

COURSE CONTENT (Module 2)

Types of Vermicomposting
biological properties

COURSE CONTENT (Module 3)

Raw materials for composting
Efficiency of vermicomposting

COURSE CONTENT (Module 4)

Advantage of vermicomposting
Application of vermicomposting

COURSE CONTENT (Module 5)

Small Scale or Indoor vermicomposting
Applications of vermicomposting

EXAMINATION

There shall be an university examination at the end of academic years.

Eligibility criteria for appearing in the final examination

- Minimum Attendance - 80%
 - Minimum Internal Assessment marks - 40%
 - It will be done through the whole year.
 - Candidate must obtain at least 35% marks in Theory.
- Internal assessment to be eligible for the university examination.

Internal assessment (Theory) will be done as follows:

- a) Mid-term and term examinations = 10 marks
- b) Assignments/Project/Class test/Clinical Presentations = 05 marks
- c) Attendance = 05 marks

Total = 20 marks

Criteria for a pass in the subject

Minimum marks in theory - 45

Scheme of Examination:-

Duration of written examination - 3 hrs
Maximum marks - 100

Level of Knowledge Expected

Working knowledge with atleast technological value

Duration of the program

45 hrs add on certificate course

Course Program Outcome

- Understanding the role of inorganic in Biochemistry
- Understanding the potential of inorganic
- Role of inorganic in Biochemistry
- Economic importance in inorganic

Eligibility criteria

Any graduate shall be eligible for the admission to the course. Intake Capacity 15 Seats on first come first basis (Additional admission to the course is permissible of the school)

Course Structure and Duration

Course is 6 month duration and will be of 45 hrs required training programme covering theoretical and practical aspects of vermicompost.

Certification

The candidate successfully qualifying for the course shall be awarded a certificate to that effect in the appropriate form by School of Arts and Science, Department of Biochemistry, PRIST University, Thanjavur, Villam.

[Signature]
Head of the Department
Department of Biochemistry
School of Arts & Science
PRIST Deemed to be University
Thanjavur-613 403

[Signature]
DEAN
School of Arts & Science
Ponnaiyah Ramajayam Institute of
Science & Technology (PRIST)
Deemed to be University
Villam, Thanjavur - Page 1002 of 1367



PONNAIYAH RAMAJAYAM INSTITUTE OF SCIENCE & TECHNOLOGY (PRIST)

Declared as DEEMED-TO-BE-UNIVERSITY
U/s 3 of UGC Act, 1956

PRIST/A&S/BC/23-24/69

28.08.2023

SCHOOL OF ARTS AND SCIENCE

DEPARTMENT OF BIOCHEMISTRY

This is to inform to all students that the value-added programmes classes for academic year 2021-2022 semester I, III, V will be commenced from 10.09.2023. Hence requesting all the registered students to attend the classes without fail.

Branch Name	Year	Course Offered
B.Sc., Biochemistry	2023-2024	Certificate course on Integumentary & Digestive System

HOD

Head of the Department
Department of Biochemistry
School of Arts & Science
PRIST Deemed to be University
Thanjavur-613 403

DEAN

DEAN
School of Arts & Science
Ponnaiyah Ramajayam Institute of
Science & Technology (PRIST)
Deemed to be University
Vallem, Thanjavur - 613 403.



PONNAIYAH RAMAJAYAM INSTITUTE OF SCIENCE & TECHNOLOGY (PRIST)

Declared as DEEMED-TO-BE-UNIVERSITY
U/s 3 of UGC Act, 1956

Value added course- (23-24) INTEGUMENTARY & DIGESTIVE SYSTEM

Unit I

The Skin: Structure and functions of skin, Surface Anatomy & Surface Markings of Human Body Ageing: Changes in the system due to ageing, Resistance to infection.

Unit II

Body as a whole: Structure and functions of Skull, Thorax, Abdomen.

Unit III

Digestive System: various parts of digestive system-Liver, Gall Bladder, Pancreas, Buccal Cavity, Pharynx, Oesophagus, Stomach and intestine -physiology of digestion and absorption.

Unit IV

Pre- analytical & analytical variables, Collection, Separation, preservation and transport of biological specimens, anticoagulants.

Unit V

Basic Principles and operations of Colorimeter, Incubator, Common balance, and Micropipette.

Books Recommended

1. Textbook of Medical Physiology--Veena Mehta Ahuja. Ane Books Pvt. Ltd. 2nd Edition
2. Introductory Practical Biochemistry-- S.K. Sawhney and Randhir Singh

Head of the Department
Department of Biochemistry
School of Arts & Science
PRIST Deemed to be University
Thanjavur-613 403

DEAN
School of Arts & Science
Ponnaiyah Ramajayam Institute of
Science & Technology (PRIST)
Deemed to be University
Vellam, Thanjavur - 613 403.

APPLICATION FORM

1. Full Name
2. Programme
3. Discipline
4. Institution Name
5. Date of Birth
6. Sex (M/F)
7. E-mail
8. Mobile No.
9. Permanent Address

Signature of the Applicant

Submission of Application Form

Submit your Application form in person to the coordinator, School of Arts and Science, PRIST University, Thanjavur, Vallam 613 403.

Application may be sent to

Course Coordinator
Dr. A. JAYALAKSHMI
Assistant Professor
Department of Biochemistry
PRIST University

About the University

Ponnaiyah Ramajayam Institute of Science and Technology (PRIST) is a deemed university in Vallam, India. The institute offers undergraduate and postgraduate courses in Engineering, Science, Education, Management, Arts, and Law, as well as research programmes.

Facilities Available

The University is housed in an independent, multi store building with state of art equipment, excellent Laboratories and infrastructure to help complete this course. Majority of seminar have been writing on maintaining the research program. Computer Library with internet facilities for students, Hostel facilities, Health centre, Sports complex, etc...

Department of Biochemistry

Life science course is very broad where you get to work and learn about all the major areas of life (biological) sciences.

The Biochemistry is focusing on some steps across the genetics, biochemistry, cell biology, molecular biology. In this course you provide much focus based on Biochemistry production.



PONNAIYAH RAMAJAYAM INSTITUTE OF SCIENCE & TECHNOLOGY (PRIST)

Deemed to be UNIVERSITY
Via 2 of BGC Act, 1956

CERTIFICATE COURSE ON INTEGUMENTARY & DIGESTIVE SYSTEM 2023-2024



COURSE OBJECTIVE

- To describe concepts of vermicomposting.
- To compare and techniques in Vermicomposting.
- To increase employability of the students.
- To improve the soil fertility by processing the waste.
- To educate about role of Earthworm
- To learn the importance of Earthworms and help to maintain a good soil structure.
- To educate about Recycling of wastes through vermicomposting.

COURSE CONTENT (Module 1)

Classification earthworm
Anatomy of earthworms

COURSE CONTENT (Module 2)

Types of Vermicomposting
biological properties

COURSE CONTENT (Module 3)

Raw materials for composting
Efficiency of vermicomposting

COURSE CONTENT (Module 4)

Advantage of vermicomposting
Application of vermicomposting

COURSE CONTENT (Module 5)

Small Scale or Indoor vermicomposting
Applications of vermicomposting

EXAMINATION

There shall be an university examination at the end of academic year.

Eligibility criteria for appearing to take in the final examination

- Minimum Attendance - 80%
- Minimum internal Assessment marks - 40%
- * It will be done through the whole year.
- * Candidate must obtain at least 50% marks in theory.
- Internal assessment to be eligible for the university examination.

Internal assessment (Theory) will be done as follows:

- a) Mid-term and term examinations = 20 marks
- b) Assignments/Projects/Class test/Class Presentation = 20 marks
- c) Attendance = 05 marks

Total = 20 marks

Criteria for a pass in the subject
Minimum marks in Theory - 45

Scheme of Examination:

Duration of written examination - 3 hrs
Maximum marks = 100

Level of Knowledge Expected

Working knowledge with excellent technological value

Duration of the program

45 hrs add on certificate course

Course Program Outcome

- Understanding the role of Phylum
- Understanding the potential of inorganic system.
- Role of digestive system.

Eligibility criteria

Any graduate shall be eligible for the admission in the course (with Capacity 15 Seats on first come first basis (Additional admission to the course is prerogative of the school)

Course Structure and Duration

Course is a 45 hrs duration and will be of 45 hrs (theoretical and practical aspects of vermicomposting).

Certification

The candidates successfully completing the course for course shall be awarded a certificate to that effect in the appropriate form by School of Arts and Science, Department of Biochemistry, PRIST University, Thanjavur, Vallam.

A. J. Jayalaxmi

Head of the Department
Department of Biochemistry
School of Arts & Science
PRIST Deemed to be University
Thanjavur-613 403

Dr. A. Jayalaxmi

DEAN
School of Arts & Science
Ponnaiyah Ramajayam Institute of
Science & Technology (PRIST)
Deemed to be University
Vallam, Thanjavur - 613 403.



PONNAIYAH RAMAJAYAM INSTITUTE OF SCIENCE & TECHNOLOGY (PRIST)

Declared as DEEMED-TO-BE-UNIVERSITY
U/s 3 of UGC Act, 1956

PRIST/A&S/BC/23-24/79

28.11.2023

SCHOOL OF ARTS AND SCIENCE

DEPARTMENT OF BIOCHEMISTRY

This is to inform to all students that the value-added programmes classes for academic year 2021-2022 semester II, IV, VI will be commenced from 10.12.2023. Hence requesting all the registered students to attend the classes without fail.

Branch Name	Year	Course Offered
Biochemistry	2023-2024	Certificate course on Lympho haemopoietic System

HOD

Head of the Department
Department of Biochemistry
School of Arts & Science
PRIST Deemed to be University
Thanjavur-613 403

DEAN

DEAN
School of Arts & Science
Ponnaiyah Ramajayam Institute of
Science & Technology (PRIST)
Deemed to be University
Valam, Thanjavur - 613 403.



PONNAIYAH RAMAJAYAM INSTITUTE OF SCIENCE & TECHNOLOGY (PRIST)

Declared as DEEMED-TO-BE-UNIVERSITY
U/s 3 of UGC Act, 1956

Value added course- (23-24) Certificate course on Lympho haemopoietic System--22515LS (45 Hours)-Syllabus

Unit-I

Haemopoietic and Lymphatic System: lymph glands & lymph vessels & lymph gland locations.

Unit-II

Body defense Mechanism: innate immunity, Acquired immunity and autoimmunity.

Unit-III

Haematological disorders: Environmental agents interfering with the haematopoietic system.

Unit-IV

Basic causes of Accidents, Common types of Laboratory accidents: Physical Injury, Electric shock, Exposure of dangerous chemicals, Poisoning with strong acids and alkali, Eye accident, Skin puncture by broken glass, Safety requirements of the laboratory First aid in laboratory accidents.

Unit V

Basic Principles and operations of cooling centrifuge, Role of microorganisms in body defense mechanism.

Books Recommended

1. Immunology--Roitt, Brostoff and Male. International edition 6th Edition.
2. Textbook of Microbiology--Ananthanarayan and Paniker-Orient Longman 7th Edition
3. Practical Clinical Biochemistry -- Harold Varley, Alan H Gowenlock and Maurice Bell. William Heinemann medical Books Limited 5th Edition.

Head of the Department
Department of Biochemistry
School of Arts & Science
PRIST Deemed to be University
Thanjavur-613 403.

DEAN
School of Arts & Science
Ponnaiyah Ramajayam Institute of
Science & Technology (PRIST)
Deemed to be University
Thanjavur - 613 403.

APPLICATION FORM

1. Full Name
2. Programme
3. Discipline
4. Institution Name
5. Date of Birth
6. Sex (M/F)
7. E-mail
8. Mobile No.
9. Permanent Address

Signature of the Applicant

Submission of Application Form

Submit your Application Form to person in the co-ordinator, School of Arts and Science, PRIST University, Thanjavur, Vellore, 611 014.

Application may be sent to

Course Coordinator
Dr. S. Subhakar
Assistant Professor
Department of Biochemistry
PRIST University

About the University

Ponnaiyah Ramajayam Institute of Science and Technology (PRIST) is a deemed university in Vellore, India. The institute offers undergraduate and postgraduate courses in Engineering, Science, Education, Management, Arts, and Law, as well as research programmes.

Facilities Available

The University is located in an independent, well-stored building with state-of-the-art equipment, excellent Laboratories and infrastructure to help complete the course. Majority of students have been using an outstanding research program Computer Literacy with internet facilities for studies. Hostel facilities, Health centre, Sports complex, etc.

Department of Biochemistry

Life science course is very broad where one get to touch and know about all the major areas of life (biological) sciences.

The Biochemistry is focusing its course major areas like genetics, biochemistry, cell biology, molecular biology. In this course you provide with broad base in biotechnological production.



PONNAYAH RAMAJAYAM INSTITUTE OF SCIENCE & TECHNOLOGY (PRIST)

Deemed to be UNIVERSITY
Via 2 of UGC Act, 1956

**CERTIFICATE COURSE ON
LYMPHOHAEMOPOIETIC SYSTEM
2023-2024**



COURSE OBJECTIVE

Understanding the haematopoietic system. Understanding the development, anatomy and physiology of the haematopoietic system is important for healthcare professionals to provide quality care for patients with blood disorders, identifying and investigating bone marrow. Understanding the mechanisms of haematopoiesis and the responses of injured haematopoietic tissue is important for identifying and interpreting bone marrow. Understanding the microscopic morphology of blood cells. Being able to describe the microscopic morphology of various blood cell types is an important objective.

COURSE CONTENT (Module 1)

Immune system

COURSE CONTENT (Module 2)

Haematopoietic stem cells

COURSE CONTENT (Module 3)

T & B cells

COURSE CONTENT (Module 4)

Lymphohaemopoietic system

COURSE CONTENT (Module 5)

Lymphohaemopoietic diseases

EXAMINATION

There shall be an university examination at the end of academic years.

Eligibility criteria for appearing in the final examination

- Minimum Attendance - 80%
- Minimum Internal Assessment marks - 40%
- It will be done through the whole year.
- Candidate must obtain at least 25% marks in theory internal assessment to be eligible for the university examination.

Internal assessment (Theory) will be done as follows:

- a) Mid-term and term examinations = 50 marks
- b) Assignments/Projects/Class test/Clinical Presentations = 25 marks
- c) Attendance = 05 marks

Total = 20 marks

Criteria for a pass in the subject

Minimum marks in theory - 45

Schedule of Examination:

Duration of written examination - 2 hrs

Maximum marks - 100

Level of Knowledge Expected

Working knowledge with essential technological value

Merits of the program

45 hrs add on certificate course

Course Program Outcome

- Understanding the role of Cancer stem.
- Understanding the potential of lymphatic system.
- Role of haematopoietic stem cells.

Eligibility criteria

Any graduate shall be eligible for the admission to the course (Total Capacity 15 seats on first-come first-basis (Additional admissions to the course is prerogative of the school).

Course Structure and Duration

Course is 4 semesters duration and will be of 45 hrs (theoretical) learning programme covering theoretical and practical aspects of immunology.

Certification

The candidate successfully completing the course the course shall be awarded a certificate to that effect to the appropriate form by School of Arts and Science, Department of Biochemistry, PRIST University, Thanjavur, Vellore.

Head of the Department
Department of Biochemistry
School of Arts & Science
PRIST Deemed to be University
Thanjavur-613 403

DEAN
School of Arts & Science
Ponnaiyah Ramajayam Instt
Science & Technology (PRIST)
Deemed to be University
Vellore, Thanjavur - 613 403.



PONNAIYAH RAMAJAYAM INSTITUTE OF SCIENCE & TECHNOLOGY (PRIST)

Declared as DEEMED-TO-BE-UNIVERSITY
U/s 3 of UGC Act, 1956

PRIST/A&S/BC/23-24/79

28.01.2024

SCHOOL OF ARTS AND SCIENCE

DEPARTMENT OF BIOCHEMISTRY

This is to inform to all students that the value-added programmes classes for academic year 2021-2022 semester II, IV, VI will be commenced from 10.02.2024. Hence requesting all the registered students to attend the classes without fail.

Branch Name	Year	Course Offered
Biochemistry	2023-2024	Certificate course on Vermicompost

HOD

Head of the Department
Department of Biochemistry
School of Arts & Science
PRIST Deemed to be University
Thanjavur-613 403

DEAN

DEAN
School of Arts & Science
Ponnaiyah Ramajayam Institute of
Science & Technology (PRIST)
Deemed to be University
Vellam, Thanjavur - 613 403.



PONNAIYAH RAMAJAYAM INSTITUTE OF SCIENCE & TECHNOLOGY (PRIST)

Declared as DEEMED-TO-BE-UNIVERSITY
U/s 3 of UGC Act, 1956

Value added course- (23-24)

Certificate course on Vermicompost -- 19115VC (45 Hours)-Syllabu

Course Description: This course covers the principles and practices of vermicomposting, a sustainable method of organic waste management using earthworms.

Course Objectives:

- Understand the basics of vermicomposting and its importance in waste management
- Learn how to design and operate a vermicomposting system
- Understand the role of earthworms in vermicomposting
- Analyze the nutritional and economic benefits of vermicompost
- Develop skills to troubleshoot common issues in vermicomposting

Module 1: Introduction to Vermicomposting

- Definition and history of vermicomposting
- Principles of vermicomposting
- Benefits of vermicomposting

Module 2: Earthworm Biology and Ecology

- Earthworm anatomy and physiology
- Earthworm species used in vermicomposting
- Earthworm behavior and ecology

Module 3: Vermicomposting Systems Design

- Types of vermicomposting systems (e.g., bins, beds, piles)
- Materials and construction considerations
- Scaling up vermicomposting systems

Module 4: Feedstock Management

- Types of organic waste suitable for vermicomposting
- Feedstock preparation and mixing

- Carbon-to-nitrogen ratio management

Module 5: Operating a Vermicomposting System

- Moisture management
- Temperature management
- pH management
- Aeration and ventilation

REFERENCES

- Vermicomposting: A Practical Guide" by Rhonda Sherman-
- Worms Eat My Garbage" by Mary Appelhof
- "The Earthworm Handbook" by Samuel W. James



Head of the Department
Department of Biochemistry
School of Arts & Science
PRIET Deemed to be University
Thanjavur-613 403



DEAN
School of Arts & Science
Ponnalyah Ramalingam Institute of
Science & Technology (PRIET)
Deemed to be University
Vallam, Thanjavur - 613 403.

APPLICATION FORM

1. Full Name
2. Photograph
3. Discipline
4. Institution Name
5. Date of Birth
6. Sex (M/F)
7. E-mail
8. Mobile No.
9. Present Address

Signature of the Applicant

Submission of Application Form
 Submit your Application form in person to the coordinator, School of Arts and Science, PRIST University, Thanjavur, Vellore, 613 403.
 Application may be sent to
Course Coordinator
 Dr. Aarthi Arangan
 Assistant Professor
 Department of Biochemistry
 PRIST University

About the University
 Ponnalysh Ramajayam Institute of Science and Technology (PRIST) is a deemed university in Vellore, India. The institute offers undergraduate and postgraduate courses in Engineering, Science, Education, Management, Arts, and Law, as well as research programmes.

Facilities Available
 The University is housed in an independent, well-stone building with state-of-the-art equipment, excellent laboratories and infrastructure to help complete this course. Majority of research have been set up in monitoring the research program. Computer Library with internet facilities for students. Hostel facilities, Health centre, Sports complex, etc.

Department of Biochemistry
 Soil science course is very broad where one get to know and know about all the major areas of Soil (biological) sciences.
 The Biochemistry is focusing on some major areas like genetics, biochemistry, cell biology, molecular biology. So this course can provide much deeper hand on Biochemistry production.



PONNALYAH RAMAJAYAM INSTITUTE OF SCIENCE & TECHNOLOGY (PRIST)
 Declared as DEEMED TO BE UNIVERSITY
 Sln 3 of SSC Act, 1956

**CERTIFICATE COURSE
 VERICOMPOST
 2023-2024**



COURSE OBJECTIVE
 - To inculcate concepts of vermicomposting.
 - To understand techniques in Vermicomposting.
 - To increase employability of the students.
 - To improve the soil quality by promoting the soil fertility.

To educate about role of Earthworms
 To learn the importance of Earthworms and help to maintain a good soil structure.
 To educate about Recycling of wastes through vermicomposting.

COURSE CONTENT (Module 1)
 Classification earthworm
 Anatomy of earthworm

COURSE CONTENT (Module 2)
 Types of Vermicomposting
 Biological properties

COURSE CONTENT (Module 3)
 Raw materials for composting
 Efficiency of vermicomposting

COURSE CONTENT (Module 4)
 Advantage of vermicomposting
 Application of vermicomposting

COURSE CONTENT (Module 5)
 Small Scale or Indoor vermicomposting
 Applications of vermicomposting

EXAMINATION
 There shall be an university examination at the end of academic years.

Eligibility criteria for appearing in the in the final examination
 Minimum Attendance - 80%
 Minimum Internal Assessment marks - 40%
 * It will be done through the whole year.
 * Candidate must obtain at least 75% marks in theory

Internal assessment to be eligible for the university examination.

Internal assessment (Theory) will be done as follows:
 a) Mid-term and term examinations = 20 marks
 b) Assignments/Projects/Class test/Clinical Presentations = 05 marks
 c) Attendance = 05 marks

Total = 20 marks

Criteria for a pass in the subject
 Minimum marks in theory - 45

Scheme of Examination:-
 Duration of written examination - 3 hrs
 Maximum marks - 100

Level of Knowledge Expected
 Working knowledge with moderate technological value

Duration of the program
 45 hrs add on certificate course

Course Program Outcome

- Understanding the role of waste farming in Modern Farming
- Understanding the potential of vermicompost as an alternative to chemical fertilizers
- Role of vermiculture in assessing the health of soil and humans
- Estimate importance of vermiculture
- Role of Vermiculture in protecting the environment and managing the waste

Eligibility criteria
 Any graduate shall be eligible for the admission to the course (Total Capacity 15 Seats on first come first basis (Additional admission to the course is prerogative of the school)

Course Structure and Duration
 Course is 6 month duration and will be of 45 hrs imparted training programme covering theoretical and practical aspects of vermicompost.

Certification
 The candidates successfully qualifying the course the course shall be awarded a certificate in that effect in the appropriate form by School of Arts and Science, Department of Biochemistry, PRIST University, Thanjavur, Vellore.

A. Arangan
 Head of the Department
 Department of Biochemistry
 School of Arts & Science
 PRIST Deemed to be University
 Thanjavur-613 403

S. Arangan
 DEAN
 School of Arts & Science
 Ponnalysh Ramajayam Institute of
 Science & Technology (PRIST)
 Deemed to be University
 Vellore, Thanjavur - 613 403.



PONNAIYAH RAMAJAYAM INSTITUTE OF SCIENCE & TECHNOLOGY (PRIST)

Declared as DEEMED-TO-BE-UNIVERSITY
U/s 3 of UGC Act, 1956

2023-2024

VALUE ADDED COURSE (Diploma Course in organic farming)

Enrolled student list

REG NO	STUDENT LIST	SIGNATURE
2301PC10101	B.AYYAPPAN	B. Ayyappan
2301PC10102	B.AKASH BABU	B. Akash Babu
2301PC10103	L.AATHIRAN	L. Aathirana
2301PC10104	D.AHILAN	D. Ahilan
2301PC10105	S.PAKALAVAN	S. Pakalavan
2301PC10106	S.NAREN	S. Naren
2301PC10107	H.MONISH	H. Monish
2301PC10108	A.LOGESH	A. Logesh
2301PC10109	N.LAXMAN	N. Lakshman
2301PC10110	A.ABINESH	A. Abinash
2301PC10111	T.LALITH	T. Lalitha
2301PC10112	K.PANDIYAN	K. Pandian
2301PC10113	R.KOWSHIK	R. Kowshik
2301PC10114	V.KISHORE	V. Kishore
2301PC10115	M.NAVEEN	M. Naveen
2301PC10116	O.DASWIN	O. Daswin
2301PC10117	J.CHANDHAN	J. Chandhan
2301PC10118	B.NAYAK	B. Nayak
2301PC10119	L.PARTHIV	L. Parthiv
2301PC10120	G.ARIYA	G. Ariya
2301PC10121	S.NIVAS	S. Nivas
2301PC10202	S.JENNIFER KAVIYA	S. Jennifer Kaviya
2301PC10203	I VINCY PRIYA	I. Vincy Priya
2301PC10204	P. ARUL ANADHI	P. Arul Anadhi
2301PC10205	M.POOJA	M. Pooja
2301PC10206	C.PRIYA	C. Priya
2301PC10207	PRIYAKA.C	Priyaka.C
2301PC10208	K.SARAVANKUMAR	K. Saravankumar
2301PC10209	L.JEYANTHI	L. Jeyanthi
2301PC10210	A.SUSMA JEBARANI	A. Susma Jebarani
2301PC10211	B.DHARSHINI	B. Dharshini
2301PC10212	N.NIRMALA	N. Nirmala
2301PC10213	S.ABIRAMI	S. Abirami

[Handwritten Signature]

Head of the Department
Department of Biochemistry
School of Arts & Science
PRIST Deemed to be University
Thiruvananthapuram

[Handwritten Signature]

DEAN
School of Arts & Science
Ponnaiyah Ramajayam Institute of
Science & Technology (PRIST)
Deemed to be University
Vallem, Thanjavur - 611 002

2301PC10214	G.SUGANTHI	G. Suganthi
2301PC10215	D.OVIYA	D. Oviya
2301PC10216	C.NEHA	C. Neha
2301PC10217	A.MEERA	Meera
2301PC10218	V.ISHA	V. Isha
2301PC10219	E.NANTHINI	E. Nanthini
2301PC10220	D.HEMA	Hema
2301PC10221	O.ILAKIYA	O. Ilakiya
2301PC10222	S.SARIKA	S. Sarika
2301PC10223	N.SANJANA	N. Sanjana
2301PC10224	R.RIA	R. Ria
2301PC10225	H.SNEKA	H. Sneka
2301PC10226	P.SRINIKA	P. Srinika
2301PC10227	V.SRUTHI	V. Sruthi

S. S. S.

Head of the Department
Department of Biochemistry
School of Arts & Science
PRIST Deemed to be University
Thanjavur-613 403

S. S. S.

DEAN
School of Arts & Science
Ponnalyah Ramajayam Institute of
Science & Technology (PRIST)
Deemed to be University
Vellam, Thanjavur - 613 403.



PONNAIYAH RAMAJAYAM INSTITUTE OF SCIENCE & TECHNOLOGY (PRIST)

Declared as DEEMED-TO-BE-UNIVERSITY
U/s 3 of UGC Act, 1956

VALUE ADDED COURSE (DIPLOMA COURSE IN ORGANIC FARMING)

TIME TABLE

S.NO	DATE	2.30-3.30 PM	3.30-4.30PM
1.	10.07.2023	DR.G.SRITHAR	R.VISWALINGAM
2.	11.07.2023	DR.G.SRITHAR	R.VISWALINGAM
3.	12.07.2023	DR.G.SRITHAR	R.VISWALINGAM
4.	13.07.2023	DR.G.SRITHAR	R.VISWALINGAM
5.	14.07.2023	DR.G.SRITHAR	R.VISWALINGAM
6.	17.07.2023	DR.G.SRITHAR	R.VISWALINGAM
7.	18.07.2023	DR.G.SRITHAR	R.VISWALINGAM
8.	19.07.2023	DR.G.SRITHAR	R.VISWALINGAM
9.	20.07.2023	DR.G.SRITHAR	R.VISWALINGAM
10.	21.07.2023	DR.G.SRITHAR	R.VISWALINGAM
11.	24.07.2023	DR.G.SRITHAR	R.VISWALINGAM
12.	25.07.2023	DR.G.SRITHAR	R.VISWALINGAM
13.	26.07.2023	DR.G.SRITHAR	R.VISWALINGAM
14.	27.07.2023	DR.G.SRITHAR	R.VISWALINGAM
15.	28.07.2023	DR.G.SRITHAR	R.VISWALINGAM
16.	31.07.2023	DR.G.SRITHAR	R.VISWALINGAM
17.	01.08.2023	DR.G.SRITHAR	R.VISWALINGAM
18.	02.08.2023	DR.G.SRITHAR	R.VISWALINGAM
19.	03.08.2023	DR.G.SRITHAR	R.VISWALINGAM
20.	04.08.2023	DR.G.SRITHAR	R.VISWALINGAM
21.	07.08.2023	DR.G.SRITHAR	R.VISWALINGAM
22.	08.08.2023	DR.G.SRITHAR	R.VISWALINGAM
23.	09.08.2023	DR.G.SRITHAR	R.VISWALINGAM
24.	10.08.2023	DR.G.SRITHAR	R.VISWALINGAM
25.	11.08.2023	DR.G.SRITHAR	R.VISWALINGAM
26.	14.08.2023	DR.G.SRITHAR	R.VISWALINGAM
27.	15.08.2023	DR.G.SRITHAR	R.VISWALINGAM
28.	16.08.2023	DR.G.SRITHAR	R.VISWALINGAM
29.	17.08.2023	DR.G.SRITHAR	R.VISWALINGAM
30.	18.08.2023	DR.G.SRITHAR	R.VISWALINGAM
31.	21.08.2023	DR.G.SRITHAR	R.VISWALINGAM
32.	22.08.2023	DR.G.SRITHAR	R.VISWALINGAM
33.	23.08.2023	DR.G.SRITHAR	R.VISWALINGAM
34.	24.08.2023	DR.G.SRITHAR	R.VISWALINGAM

35.	25.08.2023	DR.G.SRITHAR	R.VISWALINGAM
36.	28.08.2023	DR.G.SRITHAR	R.VISWALINGAM
37.	29.08.2023	DR.G.SRITHAR	R.VISWALINGAM
38.	30.08.2023	DR.G.SRITHAR	R.VISWALINGAM
39.	01.09.2023	DR.G.SRITHAR	R.VISWALINGAM
40.	02.09.2023	DR.G.SRITHAR	R.VISWALINGAM
41.	05.09.2023	DR.G.SRITHAR	R.VISWALINGAM
42.	06.09.2023	DR.G.SRITHAR	R.VISWALINGAM
43.	07.09.2023	DR.G.SRITHAR	R.VISWALINGAM
44.	08.09.2023	DR.G.SRITHAR	R.VISWALINGAM
45.	09.09.2023	DR.G.SRITHAR	R.VISWALINGAM



Head of the Department
Department of Biochemistry
School of Arts & Science
PRIST Deemed to be University
Thanjavur-613 403



DEAN
School of Arts & Science
Ponnaiyah Ramalingam Institute of
Science & Technology (PRIST)
Deemed to be University
Vallam, Thanjavur - 613 403.



**PONNAIYAH RAMAJAYAM INSTITUTE OF
SCIENCE & TECHNOLOGY (PRIST)**

Declared as DEEMED-TO-BE-UNIVERSITY
U/s 3 of UGC Act, 1956

DIPLOMA COURSE IN ORGANIC FARMING (23-24) STUDENT LIST

S.NO	REG.NO	NAME	10.07.23		11.07.2023		12.07.2023		13.07.2023		14.07.2023		17.07.2023		18.07.2023		19.07.2023		20.07.2023		21.07.2023	
			2.30 to3.30pm	3.30 to 4.30 pm	2.30 to3.30pm	3.30 to 4.30 pm	2.30 to3.30pm	3.30 to 4.30 pm	2.30 to3.30pm	3.30 to 4.30 pm	2.30 to3.30pm	3.30 to 4.30 pm	2.30 to3.30pm	3.30 to 4.30 pm	2.30 to3.30pm	3.30 to 4.30 pm	2.30 to3.30pm	3.30 to 4.30 pm	2.30 to3.30pm	3.30 to 4.30 pm	2.30 to3.30pm	3.30 to 4.30 pm
1.	2301PC10101	B.VYAPPAN	/	/	/	/	/	/	/	/	/	/	/	/	/	/	/	/	/	/	/	/
2.	2301PC10102	B.AKASH BABU	/	/	/	/	/	/	/	/	/	/	/	/	/	/	/	/	/	/	/	/
3.	2301PC10103	L.AATHIRAN	/	/	/	/	/	/	/	/	/	/	/	/	/	/	/	/	/	/	/	/
4.	2301PC10104	D.AHILAN	/	/	/	/	/	/	/	/	/	/	/	/	/	/	/	/	/	/	/	/
5.	2301PC10105	S.PAKALAVAN	/	/	/	/	/	/	/	/	/	/	/	/	/	/	/	/	/	/	/	/
6.	2301PC10106	S.NAREN	/	/	/	/	/	/	/	/	/	/	/	/	/	/	/	/	/	/	/	/
7.	2301PC10107	H.MONISH	/	/	/	/	/	/	/	/	/	/	/	/	/	/	/	/	/	/	/	/
8.	2301PC10108	A.LOOGESH	/	/	/	/	/	/	/	/	/	/	/	/	/	/	/	/	/	/	/	/
9.	2301PC10109	N.LAXMAN	/	/	/	/	/	/	/	/	/	/	/	/	/	/	/	/	/	/	/	/
10.	2301PC10110	A.ABINESH	/	/	/	/	/	/	/	/	/	/	/	/	/	/	/	/	/	/	/	/
11.	2301PC10111	T.LALITH	/	/	/	/	/	/	/	/	/	/	/	/	/	/	/	/	/	/	/	/
12.	2301PC10112	K.PANDIYAN	/	/	/	/	/	/	/	/	/	/	/	/	/	/	/	/	/	/	/	/
13.	2301PC10113	R.KOWSHIK	/	/	/	/	/	/	/	/	/	/	/	/	/	/	/	/	/	/	/	/
14.	2301PC10114	V.KISHORE	/	/	/	/	/	/	/	/	/	/	/	/	/	/	/	/	/	/	/	/
15.	2301PC10115	M.NAVEEN	/	/	/	/	/	/	/	/	/	/	/	/	/	/	/	/	/	/	/	/

S.NO	REG.NO	NAME		
1.	2301PC10101	BAYYAPPAN	/	/
2.	2301PC10102	BAKASH BABU	/	/
3.	2301PC10103	LAATHIRAN	/	/
4.	2301PC10104	DAHILAN	/	/
5.	2301PC10105	S.PAKALAVAN	/	/
6.	2301PC10106	S.NAREN	/	/
7.	2301PC10107	H.MONISH	/	/
8.	2301PC10108	A.LOGESH	/	/
9.	2301PC10109	N.LAXMAN	/	/
10.	2301PC10110	A.ABINISH	/	/
11.	2301PC10111	T.LALITH	/	/
12.	2301PC10112	K.PANDIVAN	/	/
13.	2301PC10113	R.KOWSHIK	/	/
14.	2301PC10114	V.KISHORE	/	/
15.	2301PC10115	M.NAVEEN	/	/
16.	2301PC10116	O.DASWIN	/	/
17.	2301PC10117	J.CHANDHAN	/	/
18.	2301PC10118	B.NAYAK	/	/
19.	2301PC10119	L.PARTHIV	/	/
20.	2301PC10120	G.ARIYA	/	/
21.	2301PC10121	S.NIVAS	/	/
22.	2301PC10202	S.JENNIER KAVIYA	/	/
23.	2301PC10203	I.VINCY PRIYA	/	/
			2.30 to 3.30pm	24.07.2023
			3.30 to 4.30 pm	
			2.30 to 3.30pm	25.07.2023
			3.30 to 4.30 pm	
			2.30 to 3.30pm	26.07.2023
			3.30 to 4.30 pm	
			2.30 to 3.30pm	27.07.2023
			3.30 to 4.30 pm	
			2.30 to 3.30pm	28.07.2023
			3.30 to 4.30 pm	
			2.30 to 3.30pm	31.07.2023
			3.30 to 4.30 pm	
			2.30 to 3.30pm	01.08.2023
			3.30 to 4.30 pm	
			2.30 to 3.30pm	02.08.2023
			3.30 to 4.30 pm	
			2.30 to 3.30pm	03.08.2023
			3.30 to 4.30 pm	
			2.30 to 3.30pm	04.08.2023
			3.30 to 4.30 pm	

S.NO	REG.NO	NAME		
1.	2301PC10101	BAYYAPPAN	2.30 to 3.30pm	07.08.2023
2.	2301PC10102	BAKASH BABU	3.30 to 4.30 pm	
3.	2301PC10103	L.AATHIRAN	2.30 to 3.30pm	08.08.2023
4.	2301PC10104	DAHILLAN	3.30 to 4.30 pm	
5.	2301PC10105	S.PAKALAVAN	2.30 to 3.30pm	09.08.2023
6.	2301PC10106	S.NAREN	3.30 to 4.30 pm	
7.	2301PC10107	H.MONISH	2.30 to 3.30pm	10.08.2023
8.	2301PC10108	A.LOGESH	3.30 to 4.30 pm	
9.	2301PC10109	N.LAXMAN	2.30 to 3.30pm	11.08.2023
10.	2301PC10110	A.ABHINAV	3.30 to 4.30 pm	
11.	2301PC10111	T.LALITH	2.30 to 3.30pm	14.08.2023
12.	2301PC10112	K.PANDIYAN	3.30 to 4.30 pm	
13.	2301PC10113	R.KOWSHIK	2.30 to 3.30pm	15.08.2023
14.	2301PC10114	V.KISHORE	3.30 to 4.30 pm	
15.	2301PC10115	M.NAVEEN	2.30 to 3.30pm	16.08.2023
16.	2301PC10116	O.DASWIN	3.30 to 4.30 pm	
17.	2301PC10117	J.CHANDHAN	2.30 to 3.30pm	17.08.2023
18.	2301PC10118	B.NAYAK	3.30 to 4.30 pm	
19.	2301PC10119	L.PARTHIV	2.30 to 3.30pm	18.08.2023
20.	2301PC10120	G.ARIYA	3.30 to 4.30 pm	
21.	2301PC10121	S.NIVAS	2.30 to 3.30pm	19.08.2023
22.	2301PC10202	S.JENNIFER KAVIYA	3.30 to 4.30 pm	
23.	2301PC10203	I.VINCY PRIYA	2.30 to 3.30pm	20.08.2023
			3.30 to 4.30 pm	

24.	2301PC10204	P. ARUL ANADHI	/	/	/	/	/	/	/	/	/	/	/	/	/	/	/	/	/	/	/	/	/	/
25.	2301PC10205	M.POOLJA	/	/	/	/	/	/	/	/	/	/	/	/	/	/	/	/	/	/	/	/	/	/
26.	2301PC10206	C.PRIYA	/	/	/	/	/	/	/	/	/	/	/	/	/	/	/	/	/	/	/	/	/	/
27.	2301PC10207	PRİYAKA.C	/	/	/	/	/	/	/	/	/	/	/	/	/	/	/	/	/	/	/	/	/	/
28.	2301PC10208	K.SARAVANKUMAR	/	/	/	/	/	/	/	/	/	/	/	/	/	/	/	/	/	/	/	/	/	/
29.	2301PC10209	L.JEYANTHI	/	/	/	/	/	/	/	/	/	/	/	/	/	/	/	/	/	/	/	/	/	/
30.	2301PC10210	A.SUSMA JEBARANI	/	/	/	/	/	/	/	/	/	/	/	/	/	/	/	/	/	/	/	/	/	/
31.	2301PC10211	B.DHARSHINI	/	/	/	/	/	/	/	/	/	/	/	/	/	/	/	/	/	/	/	/	/	/
32.	2301PC10212	N.NIRMALA	/	/	/	/	/	/	/	/	/	/	/	/	/	/	/	/	/	/	/	/	/	/
33.	2301PC10213	S.ABIRAMI	/	/	/	/	/	/	/	/	/	/	/	/	/	/	/	/	/	/	/	/	/	/
34.	2301PC10214	G.SUDANTHI	/	/	/	/	/	/	/	/	/	/	/	/	/	/	/	/	/	/	/	/	/	/
35.	2301PC10215	D.OVIYA	/	/	/	/	/	/	/	/	/	/	/	/	/	/	/	/	/	/	/	/	/	/
36.	2301PC10216	C.NEHA	/	/	/	/	/	/	/	/	/	/	/	/	/	/	/	/	/	/	/	/	/	/
37.	2301PC10217	A.MEERA	/	/	/	/	/	/	/	/	/	/	/	/	/	/	/	/	/	/	/	/	/	/
38.	2301PC10218	V.ISHA	/	/	/	/	/	/	/	/	/	/	/	/	/	/	/	/	/	/	/	/	/	/
39.	2301PC10219	E.NANTHINI	/	/	/	/	/	/	/	/	/	/	/	/	/	/	/	/	/	/	/	/	/	/
40.	2301PC10220	D.HEMA	/	/	/	/	/	/	/	/	/	/	/	/	/	/	/	/	/	/	/	/	/	/
41.	2301PC10221	O.JLAKIYA	/	/	/	/	/	/	/	/	/	/	/	/	/	/	/	/	/	/	/	/	/	/
42.	2301PC10222	S.SARIKA	/	/	/	/	/	/	/	/	/	/	/	/	/	/	/	/	/	/	/	/	/	/
43.	2301PC10223	N.SAMANA	/	/	/	/	/	/	/	/	/	/	/	/	/	/	/	/	/	/	/	/	/	/
44.	2301PC10224	R.RIA	/	/	/	/	/	/	/	/	/	/	/	/	/	/	/	/	/	/	/	/	/	/
45.	2301PC10225	H.SNEKA	/	/	/	/	/	/	/	/	/	/	/	/	/	/	/	/	/	/	/	/	/	/
46.	2301PC10226	P.SRENIKA	/	/	/	/	/	/	/	/	/	/	/	/	/	/	/	/	/	/	/	/	/	/
47.	2301PC10227	V.SRUTHI	/	/	/	/	/	/	/	/	/	/	/	/	/	/	/	/	/	/	/	/	/	/

Handwritten blue ink signature/initials across the bottom of the table.

S.NO	REG.NO	NAME	21.08.2023		22.08.2023	23.08.2023	24.08.2023	25.08.2023	28.08.2023	29.08.2023	30.08.2023	01.09.2023	02.09.2023
			2.30 to 3.30pm	3.30 to 4.30 pm									
1.	2301PC10101	B.VYVAPPAN	/	/	/	/	/	/	/	/	/	/	/
2.	2301PC10102	B.AKASH BABU	/	/	/	/	/	/	/	/	/	/	/
3.	2301PC10103	L.AATHIRAN	/	/	/	/	/	/	/	/	/	/	/
4.	2301PC10104	D.AHILAN	/	/	/	/	/	/	/	/	/	/	/
5.	2301PC10105	S.PAKALAVAN	/	/	/	/	/	/	/	/	/	/	/
6.	2301PC10106	S.NAREN	/	/	/	/	/	/	/	/	/	/	/
7.	2301PC10107	H.MONISH	/	/	/	/	/	/	/	/	/	/	/
8.	2301PC10108	A.LOGESH	/	/	/	/	/	/	/	/	/	/	/
9.	2301PC10109	N.LAXMAN	/	/	/	/	/	/	/	/	/	/	/
10.	2301PC10110	A.ABINESH	/	/	/	/	/	/	/	/	/	/	/
11.	2301PC10111	T.LALITH	/	/	/	/	/	/	/	/	/	/	/
12.	2301PC10112	K.PANDIYAN	/	/	/	/	/	/	/	/	/	/	/
13.	2301PC10113	R.KOWSHIK	/	/	/	/	/	/	/	/	/	/	/
14.	2301PC10114	V.KISHORE	/	/	/	/	/	/	/	/	/	/	/
15.	2301PC10115	M.NAVEEN	/	/	/	/	/	/	/	/	/	/	/
16.	2301PC10116	O.DASWIN	/	/	/	/	/	/	/	/	/	/	/
17.	2301PC10117	J.CHANDHAN	/	/	/	/	/	/	/	/	/	/	/
18.	2301PC10118	B.NAYAK	/	/	/	/	/	/	/	/	/	/	/
19.	2301PC10119	L.PARTHIV	/	/	/	/	/	/	/	/	/	/	/
20.	2301PC10120	G.ARIYA	/	/	/	/	/	/	/	/	/	/	/
21.	2301PC10121	S.NIVAS	/	/	/	/	/	/	/	/	/	/	/
22.	2301PC10202	S.JENNIFER KAVIYA	/	/	/	/	/	/	/	/	/	/	/
23.	2301PC10203	I.VINCY PRIYA	/	/	/	/	/	/	/	/	/	/	/

S.NO	REG.NO	NAME	05.09.2023		06.09.2023		07.09.2023		08.09.2023		09.09.2023								
			2.30 to 3.30pm	3.30 to 4.30 pm	2.30 to 3.30pm	3.30 to 4.30 pm	2.30 to 3.30pm	3.30 to 4.30 pm	2.30 to 3.30pm	3.30 to 4.30 pm	2.30 to 3.30pm	3.30 to 4.30 pm							
1.	2301PC10101	B.VYAPPAN	/	/	/	/	/	/	/	/	/	/							
2.	2301PC10102	B.KASH BABU	/	/	/	/	/	/	/	/	/	/							
3.	2301PC10103	L.AATHIRAN	/	/	/	/	/	/	/	/	/	/							
4.	2301PC10104	D.AHILAN	/	/	/	/	/	/	/	/	/	/							
5.	2301PC10105	S.PAKALAVAN	/	/	/	/	/	/	/	/	/	/							
6.	2301PC10106	S.NAREN	/	/	/	/	/	/	/	/	/	/							
7.	2301PC10107	H.MONISH	/	/	/	/	/	/	/	/	/	/							
8.	2301PC10108	A.LOGESH	/	/	/	/	/	/	/	/	/	/							
9.	2301PC10109	N.LAXMAN	/	/	/	/	/	/	/	/	/	/							
10.	2301PC10110	A.ABINESH	/	/	/	/	/	/	/	/	/	/							
11.	2301PC10111	T.LALITH	/	/	/	/	/	/	/	/	/	/							
12.	2301PC10112	K.PANDYAN	/	/	/	/	/	/	/	/	/	/							
13.	2301PC10113	R.KOWSHIK	/	/	/	/	/	/	/	/	/	/							
14.	2301PC10114	V.KISHORE	/	/	/	/	/	/	/	/	/	/							
15.	2301PC10115	M.NAVEEN	/	/	/	/	/	/	/	/	/	/							
16.	2301PC10116	O.DASWIN	/	/	/	/	/	/	/	/	/	/							
17.	2301PC10117	J.CHANDHAN	/	/	/	/	/	/	/	/	/	/							
18.	2301PC10118	B.NAYAK	/	/	/	/	/	/	/	/	/	/							
19.	2301PC10119	L.PARTHIY	/	/	/	/	/	/	/	/	/	/							
20.	2301PC10120	G.ARIYA	/	/	/	/	/	/	/	/	/	/							
21.	2301PC10121	S.NIVAS	/	/	/	/	/	/	/	/	/	/							
22.	2301PC10202	S.JENNIKER KAVIYA	/	/	/	/	/	/	/	/	/	/							
23.	2301PC10203	I.VINCY PRIYA	/	/	/	/	/	/	/	/	/	/							



PONNAIYAH RAMAJAYAM INSTITUTE OF SCIENCE & TECHNOLOGY (PRIST)

Declared as DEEMED-TO-BE-UNIVERSITY
U/s 3 of UGC Act, 1956

2023-2024

VALUE ADDED COURSE (Certificate course in Techniques in Biochemistry)

Enrolled student list

REG NO	STUDENT LIST
2201PC10201	Keerthika .C
2201PC10203	Amrita M
2201PC10204	Deepti R
2201PC10205	Indu S
2201PC10206	Ritika C
2201PC10207	Aisha B
2201PC10208	Anika A
2201PC10209	Fatima N
2201PC10210	Laila M
2201PC10211	Samira B
2201PC10212	Veda A
2201PC10213	Nithya A
2201PC10214	Padma C
2201PC10215	Radha P
2201PC10216	Sandhya S
2201PC10217	Sumati D
2201PC10218	Usha S
2201PC10219	Kamini M
2201PC10220	Rashmi. B
2201PC10221	Amala U
2201PC10222	Malini R
2201PC10223	Rajani G
2201PC10224	Anoushka A
2201PC10225	Indumathi R

2201PC10226	Rajkumari T
2201PC10227	Vasundhara J
2201PC10228	Gayathri
2201PC10229	Saraswati K
2201PC10230	Vaishnavi N
2201PC10231	Aparna S
2201PC10101	K.Supramani
2201PC10102	Rohan D
2201PC10103	Kabir B
2201PC10104	Zahir C
2201PC10105	Ganesh S
2201PC10106	Krishna.T
2201PC10107	Manish K
2201PC10108	Ravindra J
2201PC10109	Surendra S
2201PC10110	Vishnu T
2201PC10111	Ashwin G
2201PC10112	Kamal M
2201PC10113	Rakesh N
2201PC10114	Suraj V
2201PC10115	Bhaskar C
2201PC10116	Dinesh G
2201PC10117	Harish M
2201PC10118	Prabhakar S
2201PC10119	Shankar S

S. S. S.

Head of the Department
Department of Biochemistry
School of Arts & Science
PRUST Deemed to be University
Thanjavur-613 403

S. S. S.

DEAN
School of Arts & Science
Ponnalyah Ramajayam Institute of
Science & Technology
Deemed to be University
Villom, Thanjavur - 613 403.



PONNAIYAH RAMAJAYAM INSTITUTE OF SCIENCE & TECHNOLOGY (PRIST)

Declared as DEEMED-TO-BE-UNIVERSITY
U/s 3 of UGC Act, 1956

VALUE ADDED COURSE (Certificate course on Techniques in Biochemistry) TIME TABLE

S.NO	DATE	2.30-3.30 PM	3.30-4.30PM
1.	10.08.2023	DR.A.SUNDARESAN	DR.S.SATHISHKUMAR
2.	11.08.2023	DR.A.SUNDARESAN	DR.S.SATHISHKUMAR
3.	12.08.2023	DR.A.SUNDARESAN	DR.S.SATHISHKUMAR
4.	13.08.2023	DR.A.SUNDARESAN	DR.S.SATHISHKUMAR
5.	14.08.2023	DR.A.SUNDARESAN	DR.S.SATHISHKUMAR
6.	19.08.2023	DR.A.SUNDARESAN	DR.S.SATHISHKUMAR
7.	20.08.2023	DR.A.SUNDARESAN	DR.S.SATHISHKUMAR
8.	21.08.2023	DR.A.SUNDARESAN	DR.S.SATHISHKUMAR
9.	22.08.2023	DR.A.SUNDARESAN	DR.S.SATHISHKUMAR
10.	24.08.2023	DR.A.SUNDARESAN	DR.S.SATHISHKUMAR
11.	24.08.2023	DR.A.SUNDARESAN	DR.S.SATHISHKUMAR
12.	25.08.2023	DR.A.SUNDARESAN	DR.S.SATHISHKUMAR
13.	26.08.2023	DR.A.SUNDARESAN	DR.S.SATHISHKUMAR
14.	28.08.2023	DR.A.SUNDARESAN	DR.S.SATHISHKUMAR
15.	28.08.2023	DR.A.SUNDARESAN	DR.S.SATHISHKUMAR
16.	31.08.2023	DR.A.SUNDARESAN	DR.S.SATHISHKUMAR
17.	01.09.2023	DR.A.SUNDARESAN	DR.S.SATHISHKUMAR
18.	02.09.2023	DR.A.SUNDARESAN	DR.S.SATHISHKUMAR
19.	03.09.2023	DR.A.SUNDARESAN	DR.S.SATHISHKUMAR
20.	04.09.2023	DR.A.SUNDARESAN	DR.S.SATHISHKUMAR
21.	08.09.2023	DR.A.SUNDARESAN	DR.S.SATHISHKUMAR
22.	09.09.2023	DR.A.SUNDARESAN	DR.S.SATHISHKUMAR
23.	10.09.2023	DR.A.SUNDARESAN	DR.S.SATHISHKUMAR

Head of the Department
Department of Biochemistry
School of Arts & Science
PRIST Deemed to be University
Thanjavur-613 403

DEAN
School of Arts & Science
Ponnaiyah Ramajayam Institute of
Science & Technology (PRIST)
Deemed to be University
Vellam, Thanjavur - 613 403.



**PONNAIYAH RAMAJAYAM INSTITUTE OF
SCIENCE & TECHNOLOGY (PRIST)**

Declared as DEEMED-TO-BE UNIVERSITY
U/s 3 of UGC Act, 1956

CERTIFICATE COURSE ON TECHNIQUES IN BIOCHEMISTRY (23-24) STUDENT LIST

S.NO	REG.NO	NAME	10.08.2023		11.08.2023		12.08.2023		13.08.2023		14.08.2023		18.08.2023		19.08.2023		20.08.2023		21.08.2023		22.08.2023	
			2.30 to 3.30pm	3.30 to 4.30 pm	2.30 to 3.30pm	3.30 to 4.30 pm	2.30 to 3.30pm	3.30 to 4.30 pm	2.30 to 3.30pm	3.30 to 4.30 pm	2.30 to 3.30pm	3.30 to 4.30 pm	2.30 to 3.30pm	3.30 to 4.30 pm	2.30 to 3.30pm	3.30 to 4.30 pm	2.30 to 3.30pm	3.30 to 4.30 pm	2.30 to 3.30pm	3.30 to 4.30 pm	2.30 to 3.30pm	3.30 to 4.30 pm
1.	2201PC10201	Keerthika .C	/	/	/	/	/	/	/	/	/	/	/	/	/	/	/	/	/	/	/	/
2.	2201PC10203	Amrita M	/	/	/	/	/	/	/	/	/	/	/	/	/	/	/	/	/	/	/	/
3.	2201PC10204	Deepthi R	/	/	/	/	/	/	/	/	/	/	/	/	/	/	/	/	/	/	/	/
4.	2201PC10205	Indu S	/	/	/	/	/	/	/	/	/	/	/	/	/	/	/	/	/	/	/	/
5.	2201PC10206	Rithika C	/	/	△	△	/	/	/	/	/	/	/	/	/	/	/	/	/	/	/	/
6.	2201PC10207	Aisha B	/	/	/	/	/	/	/	/	/	/	/	/	/	/	/	/	/	/	/	/
7.	2201PC10208	Anika A	/	/	/	/	/	/	/	/	/	/	/	/	/	/	/	/	/	/	/	/
8.	2201PC10209	Fatima N	/	/	/	/	/	/	/	/	/	/	/	/	/	/	/	/	/	/	/	/
9.	2201PC10210	Laila M	/	/	/	/	/	/	/	/	/	/	/	/	/	/	/	/	/	/	/	/
10.	2201PC10211	Senitra B	/	/	/	/	/	/	/	/	/	/	/	/	/	/	/	/	/	/	/	/
11.	2201PC10212	Veda A	/	/	/	/	/	/	/	/	/	/	/	/	/	/	/	/	/	/	/	/
12.	2201PC10213	Nithya A	/	/	/	/	/	/	/	/	/	/	/	/	/	/	/	/	/	/	/	/
13.	2201PC10214	Padma C	/	/	/	/	/	/	/	/	/	/	/	/	/	/	/	/	/	/	/	/
14.	2201PC10215	Radhika P	/	/	/	/	/	/	/	/	/	/	/	△	/	/	/	/	/	/	/	/
15.	2201PC10216	Sandhya S	/	/	/	/	/	/	/	/	/	/	/	/	/	/	/	/	/	/	/	/

S.NO	REG.NO	NAME	24.08.2023		25.08.2023		26.08.2023		28.08.2023		28.08.2023		31.08.2023		01.09.2023		02.09.2023		03.09.2023		04.09.2023	
			2.30 to 3.30pm	3.30 to 4.30 pm	2.30 to 3.30pm	3.30 to 4.30 pm	2.30 to 3.30pm	3.30 to 4.30 pm	2.30 to 3.30pm	3.30 to 4.30 pm	2.30 to 3.30pm	3.30 to 4.30 pm	2.30 to 3.30pm	3.30 to 4.30 pm	2.30 to 3.30pm	3.30 to 4.30 pm	2.30 to 3.30pm	3.30 to 4.30 pm	2.30 to 3.30pm	3.30 to 4.30 pm	2.30 to 3.30pm	3.30 to 4.30 pm
1.	2201PC10201	Keerthika .C	/	/	/	/	/	/	/	/	/	/	/	/	/	/	/	/	/	/	/	/
2.	2201PC10203	Amrita M	/	/	/	/	/	/	/	/	/	/	/	/	/	/	/	/	/	/	/	/
3.	2201PC10204	Deepti R	/	/	/	/	/	/	/	/	/	/	/	/	/	/	/	/	/	/	/	/
4.	2201PC10205	Indu S	/	/	/	/	/	/	/	/	/	/	/	/	/	/	/	/	/	/	/	/
5.	2201PC10206	Ritika C	/	/	/	/	/	/	/	/	/	/	/	/	/	/	/	/	/	/	/	/
6.	2201PC10207	Aisha B	/	/	/	/	/	/	/	/	/	/	/	/	/	/	/	/	/	/	/	/
7.	2201PC10208	Anika A	/	/	/	/	/	/	/	/	/	/	/	/	/	/	/	/	/	/	/	/
8.	2201PC10209	Fatima N	/	/	/	/	/	/	/	/	/	/	/	/	/	/	/	/	/	/	/	/
9.	2201PC10210	Laila M	/	/	/	/	/	/	/	/	/	/	/	/	/	/	/	/	/	/	/	/
10.	2201PC10211	Samira B	/	/	/	/	/	/	/	/	/	/	/	/	/	/	/	/	/	/	/	/
11.	2201PC10212	Veda A	/	/	/	/	/	/	/	/	/	/	/	/	/	/	/	/	/	/	/	/
12.	2201PC10213	Nithya A	/	/	/	/	/	/	/	/	/	/	/	/	/	/	/	/	/	/	/	/
13.	2201PC10214	Padma C	/	/	/	/	/	/	/	/	/	/	/	/	/	/	/	/	/	/	/	/
14.	2201PC10215	Radha P	/	/	/	/	/	/	/	/	/	/	/	/	/	/	/	/	/	/	/	/
15.	2201PC10216	Sandhya S	/	/	/	/	/	/	/	/	/	/	/	/	/	/	/	/	/	/	/	/
16.	2201PC10217	Surnasi D	/	/	/	/	/	/	/	/	/	/	/	/	/	/	/	/	/	/	/	/
17.	2201PC10218	Usha S	/	/	/	/	/	/	/	/	/	/	/	/	/	/	/	/	/	/	/	/
18.	2201PC10219	Karinti M	/	/	/	/	/	/	/	/	/	/	/	/	/	/	/	/	/	/	/	/
19.	2201PC10220	Rashmi. B	/	/	/	/	/	/	/	/	/	/	/	/	/	/	/	/	/	/	/	/
20.	2201PC10221	Amala U	/	/	/	/	/	/	/	/	/	/	/	/	/	/	/	/	/	/	/	/
21.	2201PC10222	Malini R	/	/	/	/	/	/	/	/	/	/	/	/	/	/	/	/	/	/	/	/
22.	2201PC10223	Rajani G	/	/	/	/	/	/	/	/	/	/	/	/	/	/	/	/	/	/	/	/
23.	2201PC10224	Anoushka A	/	/	/	/	/	/	/	/	/	/	/	/	/	/	/	/	/	/	/	/
24.	2201PC10225	Indunathi R	/	/	/	/	/	/	/	/	/	/	/	/	/	/	/	/	/	/	/	/
25.	2201PC10226	Rajkumari T	/	/	/	/	/	/	/	/	/	/	/	/	/	/	/	/	/	/	/	/

26.	2201PC10227	Vasundhara J	/	/	/	/	/	/	/	/	/	/	/	/	/	/	/	/	/	/
27.	2201PC10228	Gayatri	/	/	/	/	/	/	/	/	/	/	/	/	/	/	/	/	/	/
28.	2201PC10229	Saraswati K	/	/	/	/	/	/	/	/	/	/	/	/	/	/	/	/	/	/
29.	2201PC10230	Vaishnavi N	/	/	/	/	/	/	/	/	/	/	/	/	/	/	/	/	/	/
30.	2201PC10231	Aparna S	/	/	/	/	/	/	/	/	/	/	/	/	/	/	/	/	/	/
31.	2201PC10101	K.Supramani	/	/	/	/	/	/	/	/	/	/	/	/	/	/	/	/	/	/
32.	2201PC10102	Rohan D	/	/	/	/	/	/	/	/	/	/	/	/	/	/	/	/	/	/
33.	2201PC10103	Kabir B	/	/	/	/	/	/	/	/	/	/	/	/	/	/	/	/	/	/
34.	2201PC10104	Zahir C	/	/	/	/	/	/	/	/	/	/	/	/	/	/	/	/	/	/
35.	2201PC10105	Ganesh S	/	/	/	/	/	/	/	/	/	/	/	/	/	/	/	/	/	/
36.	2201PC10106	Krishna.T	/	/	/	/	/	/	/	/	/	/	/	/	/	/	/	/	/	/
37.	2201PC10107	Manish K	/	/	/	/	/	/	/	/	/	/	/	/	/	/	/	/	/	/
38.	2201PC10108	Ravindra J	/	/	/	/	/	/	/	/	/	/	/	/	/	/	/	/	/	/
39.	2201PC10109	Surendra S	/	/	/	/	/	/	/	/	/	/	/	/	/	/	/	/	/	/
40.	2201PC10110	Vishnu T	/	/	/	/	/	/	/	/	/	/	/	/	/	/	/	/	/	/
41.	2201PC10111	Ashwin G	/	/	/	/	/	/	/	/	/	/	/	/	/	/	/	/	/	/
42.	2201PC10112	Kamal M	/	/	/	/	/	/	/	/	/	/	/	/	/	/	/	/	/	/
43.	2201PC10113	Rakesh N	/	/	/	/	/	/	/	/	/	/	/	/	/	/	/	/	/	/
44.	2201PC10114	Suraj V	/	/	/	/	/	/	/	/	/	/	/	/	/	/	/	/	/	/
45.	2201PC10115	Bhaskar C	/	/	/	/	/	/	/	/	/	/	/	/	/	/	/	/	/	/
46.	2201PC10116	Dinesh G	/	/	/	/	/	/	/	/	/	/	/	/	/	/	/	/	/	/
47.	2201PC10117	Harith M	/	/	/	/	/	/	/	/	/	/	/	/	/	/	/	/	/	/
48.	2201PC10118	Prabhakar S	/	/	/	/	/	/	/	/	/	/	/	/	/	/	/	/	/	/
49.	2201PC10119	Shankar S	/	/	/	/	/	/	/	/	/	/	/	/	/	/	/	/	/	/

[Handwritten notes and signatures in blue ink are present in the left margin, including the name "SHANKAR S" and various initials and marks.]

S.NO	REG.NO	NAME	08.09.2023		09.09.2023		10.09.2023	
			2.30 to 3.30pm	3.30 to 4.30 pm	2.30 to 3.30pm	3.30 to 4.30 pm	2.30 to 3.30pm	3.30 to 4.30 pm
1.	2201PC10201	Keerthika .C	Q	Q				
2.	2201PC10203	Amrita M						
3.	2201PC10204	Deepthi R						
4.	2201PC10205	Indu S						
5.	2201PC10206	Ritika C						
6.	2201PC10207	Aisha B						
7.	2201PC10208	Anika A						
8.	2201PC10209	Fatima N				Q	Q	
9.	2201PC10210	Laila M						
10.	2201PC10211	Santra B						
11.	2201PC10212	Veda A						
12.	2201PC10213	Nithya A			Q			
13.	2201PC10214	Padma C						
14.	2201PC10215	Radhya P						
15.	2201PC10216	Sandhya S						
16.	2201PC10217	Sumati D						
17.	2201PC10218	Usha S						
18.	2201PC10219	Karinti M						
19.	2201PC10220	Rashmi. B						
20.	2201PC10221	Arnala U						
21.	2201PC10222	Moliti R						
22.	2201PC10223	Rajani G						
23.	2201PC10224	Ancushka A						
24.	2201PC10225	Indumathi R						
25.	2201PC10226	Rajkumari T	Q	Q	Q	Q	Q	

26.	2201PC10227	Vasundhara J	A	A	/	/	/	/	/										
27.	2201PC10228	Gayathri	/	/	/	/	/	/	/										
28.	2201PC10229	Saraswati K	/	/	/	/	/	/	/										
29.	2201PC10230	Vaishnavi N	/	/	/	/	/	/	/										
30.	2201PC10231	Aparna S	/	/	/	/	/	/	/										
31.	2201PC10101	K. Suprannati	/	/	A	A	/	/	/										
32.	2201PC10102	Rohan D	/	/	/	/	/	/	/										
33.	2201PC10103	Kabir B	/	/	/	/	/	/	/										
34.	2201PC10104	Zahir C	/	/	/	/	/	/	/										
35.	2201PC10105	Ganasha S	/	/	/	/	/	/	/										
36.	2201PC10106	Krishna T	/	/	/	/	/	/	/										
37.	2201PC10107	Manish K	/	/	/	/	/	/	/										
38.	2201PC10108	Ravindra J	/	/	/	/	/	/	/										
39.	2201PC10109	Surendra S	/	/	/	/	A	A	/										
40.	2201PC10110	Vishnu T	/	/	/	/	/	/	/										
41.	2201PC10111	Ashwin G	/	/	/	/	/	/	/										
42.	2201PC10112	Karnal M	/	/	/	/	/	/	/										
43.	2201PC10113	Rukesh N	/	/	/	/	/	/	/										
44.	2201PC10114	Suraj V	/	/	/	/	/	/	/										
45.	2201PC10115	Bhaskar C	/	/	/	/	/	/	/										
46.	2201PC10116	Dinesh G	/	/	/	/	/	/	/										
47.	2201PC10117	Harish M	/	/	/	/	/	A	A										
48.	2201PC10118	Prabhakar S	A	A	/	/	/	/	/										
49.	2201PC10119	Shankar S	/	/	/	/	/	/	/										

(Signature)

(Signature)

Head of the Department
 Department of Biochemistry
 School of Arts & Science
 PRIST Deemed to be University
 Thanjavur-613 403

(Signature)

DEAN
 School of Arts & Science
 Ponnaiyah Ramalinga Anna
 Science & Technology
 Deemed to be University
 Mysore, Thanjavur - 613 403.



PONNAIYAH RAMAJAYAM INSTITUTE OF SCIENCE & TECHNOLOGY (PRIST)

Declared as DEEMED-TO-BE-UNIVERSITY
U/s 3 of UGC Act, 1956

2023-2024

VALUE ADDED COURSE

(Certificate course on Integumentary & Digestive System)

Enrolled student list

S.NO	REG NO	STUDENT LIST
1.	2101PC10205	A.KEERTHANA
2.	2101PC10206	S.ANJALI
3.	2101PC10207	KALPANA.G
4.	2101PC10208	RANYA .K
5.	2101PC10209	YUVARANJANI .S
6.	2101PC10210	JOHN PAUL R
7.	2101PC10211	DIVYA A
8.	2101PC10212	B.PRAVEENA
9.	2101PC10213	B.ISHWARYA
10.	2101PC10214	S.VARTHANI
11.	2101PC10215	P.REBECCA
12.	2101PC10216	B.PRIYADHARSHINI
13.	2101PC10217	S.SOUNDHARYA
14.	2101PC10218	B.ABINAYA
15.	2101PC10219	A.SIVARANJANI
16.	2101PC10220	A.KAVITHA
17.	2101PC10221	C.AMIRTHA
18.	2101PC10222	SNEHA.B
19.	2101PC10223	A.N.SANDHIYA
20.	2101PC10224	R.DHANUSIYA
21.	2101PC10225	S.BAVATHARANI
22.	2101PC10226	K.KANNIGA
23.	2101PC10227	S.KAVIPRIYA
24.	2101PC10228	M.SWETHA
25.	2101PC10229	S.DEEPIKA
26.	2101PC10230	DEEPALAKSHMI.V
27.	2101PC10231	R.RITHIKAA
28.	2101PC10232	K.INIYA
29.	2101PC10233	S.ANJALI
30.	2101PC10234	L.SUSMA
31.	2101PC10101	N.KARINA
32.	2101PC10102	T.YALINI
33.	2101PC10103	C.DEVI
34.	2101PC10104	M.SALIM
35.	2101PC10105	M.SANTHOSH
36.	2101PC10106	G.SIVAKANTHAN
37.	2101PC10107	P.KESAVAN

38.	210IPC10108	S.PRABAKARAN
39.	210IPC10109	M.ABDUL RAHIM
40.	210IPC10110	S.PRAVEEN
41.	210IPC10111	B.JUSTIN VISHNU
42.	210IPC10112	K.HARIHARAN
43.	210IPC10113	GOKUL S
44.	210IPC10114	P V NAVEEN
45.	210IPC10115	U.S.MOHAMED SHARIF
46.	210IPC10116	R.PANDIYAN
47.	210IPC10117	MOHAMED SHEIK ABDULLAH.M
48.	210IPC10118	A.DHIVAKAR

Ashly

Head of the Department
Department of Biochemistry
School of Arts & Science
PRIST Deemed to be University
Thanjavur-613 403

Devin

DEAN
School of Arts & Science
Ponnalyah Ramajeyam Institute of
Science & Technology (PRIST)
Deemed to be University
Valiam, Thanjavur - 613 403.



PONNAIYAH RAMAJAYAM INSTITUTE OF SCIENCE & TECHNOLOGY (PRIST)

Declared as DEEMED-TO-BE-UNIVERSITY
U/s 3 of UGC Act, 1956

VALUE ADDED COURSE (Certificate course on Integumentary and Digestive system) TIME TABLE

S.NO	DATE	2.30-3.30 PM	3.30-4.30PM
1.	10.09.2023	DR.A.SUNDARESAN	DR.S.SATHISHKUMAR
2.	11.09.2023	DR.A.SUNDARESAN	DR.S.SATHISHKUMAR
3.	12.09.2023	DR.A.SUNDARESAN	DR.S.SATHISHKUMAR
4.	13.09.2023	DR.A.SUNDARESAN	DR.S.SATHISHKUMAR
5.	14.09.2023	DR.A.SUNDARESAN	DR.S.SATHISHKUMAR
6.	19.09.2023	DR.A.SUNDARESAN	DR.S.SATHISHKUMAR
7.	20.09.2023	DR.A.SUNDARESAN	DR.S.SATHISHKUMAR
8.	21.09.2023	DR.A.SUNDARESAN	DR.S.SATHISHKUMAR
9.	22.09.2023	DR.A.SUNDARESAN	DR.S.SATHISHKUMAR
10.	24.09.2023	DR.A.SUNDARESAN	DR.S.SATHISHKUMAR
11.	24.09.2023	DR.A.SUNDARESAN	DR.S.SATHISHKUMAR
12.	25.09.2023	DR.A.SUNDARESAN	DR.S.SATHISHKUMAR
13.	26.09.2023	DR.A.SUNDARESAN	DR.S.SATHISHKUMAR
14.	28.09.2023	DR.A.SUNDARESAN	DR.S.SATHISHKUMAR
15.	29.09.2023	DR.A.SUNDARESAN	DR.S.SATHISHKUMAR
16.	30.09.2023	DR.A.SUNDARESAN	DR.S.SATHISHKUMAR
17.	01.10.2023	DR.A.SUNDARESAN	DR.S.SATHISHKUMAR
18.	02.10.2023	DR.A.SUNDARESAN	DR.S.SATHISHKUMAR
19.	03.10.2023	DR.A.SUNDARESAN	DR.S.SATHISHKUMAR
20.	04.10.2023	DR.A.SUNDARESAN	DR.S.SATHISHKUMAR
21.	08.10.2023	DR.A.SUNDARESAN	DR.S.SATHISHKUMAR
22.	09.10.2023	DR.A.SUNDARESAN	DR.S.SATHISHKUMAR
23.	10.10.2023	DR.A.SUNDARESAN	DR.S.SATHISHKUMAR

Head of the Department
Department of Biochemistry
School of Arts & Science
PRIST Deemed to be University
Thanjavur-613 403

DEAN
School of Arts & Science
Ponnaiyah Ramajayam Institute of
Science & Technology (PRIST)
Deemed to be University
Vellam, Thanjavur - 613 403.



**PONNAIYAH RAMAJAYAM INSTITUTE OF
SCIENCE & TECHNOLOGY (PRIST)**

Declared as DEEMED TO BE UNIVERSITY
U/s 3 of UGC Act, 1956

CERTIFICATE COURSE ON INTEGUMENTARY & DIGESTIVE SYSTEM (23-24) STUDENT LIST

S.NO	REG.NO	NAME	10.09.2023		11.09.2023		12.09.2023		13.09.2023		14.09.2023		19.09.2023		20.09.2023		21.09.2023		22.09.2023		24.09.2023	
			2.30 to 3.30pm	3.30 to 4.30 pm	2.30 to 3.30pm	3.30 to 4.30 pm	2.30 to 3.30pm	3.30 to 4.30 pm	2.30 to 3.30pm	3.30 to 4.30 pm	2.30 to 3.30pm	3.30 to 4.30 pm	2.30 to 3.30pm	3.30 to 4.30 pm	2.30 to 3.30pm	3.30 to 4.30 pm	2.30 to 3.30pm	3.30 to 4.30 pm	2.30 to 3.30pm	3.30 to 4.30 pm		
1.	2101PC10205	A.KEERTHANA	/	/	/	/	/	/	/	/	/	/	/	/	/	/	/	/	/	/	/	/
2.	2101PC10206	S.ANJALI	/	/	/	/	/	/	/	/	/	/	/	/	/	/	/	/	/	/	/	/
3.	2101PC10207	KALPANA.G	/	/	/	/	/	/	/	/	/	/	/	/	/	/	/	/	/	/	/	/
4.	2101PC10208	RANYA.K	/	/	/	/	/	/	/	/	/	/	/	/	/	/	/	/	/	/	/	/
5.	2101PC10209	YUVARAJANI.S	/	/	/	/	/	/	/	/	/	/	/	/	/	/	/	/	/	/	/	/
6.	2101PC10210	JOHN PAUL R	/	/	/	/	/	/	/	/	/	/	/	/	/	/	/	/	/	/	/	/
7.	2101PC10211	DIVYA A	/	/	/	/	/	/	/	/	/	/	/	/	/	/	/	/	/	/	/	/
8.	2101PC10212	B.PRAVEENA	/	/	/	/	/	/	/	/	/	/	/	/	/	/	/	/	/	/	/	/
9.	2101PC10213	B.ISHWARYA	/	/	/	/	/	/	/	/	/	/	/	/	/	/	/	/	/	/	/	/
10.	2101PC10214	S.VARTHANI	/	/	/	/	/	/	/	/	/	/	/	/	/	/	/	/	/	/	/	/
11.	2101PC10215	P.REBECCA	/	/	/	/	/	/	/	/	/	/	/	/	/	/	/	/	/	/	/	/
12.	2101PC10216	B.PRIYADHARSHINI	/	/	/	/	/	/	/	/	/	/	/	/	/	/	/	/	/	/	/	/
13.	2101PC10217	S.SOUNDHARYA	/	/	/	/	/	/	/	/	/	/	/	/	/	/	/	/	/	/	/	/
14.	2101PC10218	B.ABINAYA	/	/	/	/	/	/	/	/	/	/	/	/	/	/	/	/	/	/	/	/
15.	2101PC10219	A.SIVARANJANI	/	/	/	/	/	/	/	/	/	/	/	/	/	/	/	/	/	/	/	/

48. 2101PCI0118 A.DHIVAKAR

Handwritten signature and notes in blue ink, including the name 'S. R. S. I. I. A.' and other illegible characters.

S.NO	REG.NO	NAME		
1.	2101PCI0205	A.KEERTHANA	24.09.2023	2.30 to 3.30pm
2.	2101PCI0206	S.ANJALI		3.30 to 4.30 pm
3.	2101PCI0207	KALPANA.G	25.09.2023	2.30 to 3.30pm
4.	2101PCI0208	RANYA.K		3.30 to 4.30 pm
5.	2101PCI0209	YUVARANJANI.S	26.09.2023	2.30 to 3.30pm
6.	2101PCI0210	JOHN PAUL.R		3.30 to 4.30 pm
7.	2101PCI0211	DIVYA.A	28.09.2023	2.30 to 3.30pm
8.	2101PCI0212	B.PRAVEENA		3.30 to 4.30 pm
9.	2101PCI0213	B.SHWARYA	29.09.2023	2.30 to 3.30pm
10.	2101PCI0214	S.VARTHANI		3.30 to 4.30 pm
11.	2101PCI0215	P.REBECCA	30.09.2023	2.30 to 3.30pm
12.	2101PCI0216	B.PRIYADHARSHINI		3.30 to 4.30 pm
13.	2101PCI0217	S.SOUNDHARYA	01.10.2023	2.30 to 3.30pm
14.	2101PCI0218	B.ABINAYA		3.30 to 4.30 pm
15.	2101PCI0219	A.SIVARANJANI	02.10.2023	2.30 to 3.30pm
16.	2101PCI0220	A.KAVITHA		3.30 to 4.30 pm
17.	2101PCI0221	C.AMIRTHA	03.10.2023	2.30 to 3.30pm
18.	2101PCI0222	SNEHAB		3.30 to 4.30 pm

19.	2101PC10223	A.N.SANDHIYA																		
20.	2101PC10224	R.DHANUSIYA																		
21.	2101PC10225	S.BAVATHARANI																		
22.	2101PC10226	K.KANNIGA																		
23.	2101PC10227	S.KAVIPRIYA																		
24.	2101PC10228	M.SWETHA																		
25.	2101PC10229	S.DEEPIKA																		
26.	2101PC10230	DEEPA LAKSHMI V																		
27.	2101PC10231	R.RITHIKAA																		
28.	2101PC10232	K.INIYA																		
29.	2101PC10233	S.AN/ALI																		
30.	2101PC10234	L.SUSMA																		
31.	2101PC10101	N.KARINA																		
32.	2101PC10102	T.YALINI																		
33.	2101PC10103	C.DEVI																		
34.	2101PC10104	M.SALIM																		
35.	2101PC10105	M.SANTHOSH																		
36.	2101PC10106	G.SIVAKANTHAN																		
37.	2101PC10107	P.KESAVAN																		
38.	2101PC10108	S.PRABAKARAN																		
39.	2101PC10109	M.ABDUL RAHIM																		
40.	2101PC10110	S.PRAVEEN																		
41.	2101PC10111	B.JUSTIN VISHNU																		
42.	2101PC10112	K.HARIHARAN																		
43.	2101PC10113	GOKUL S																		
44.	2101PC10114	P V NAVEEN																		
45.	2101PC10115	U.S.MOHAMED SHARIF																		
46.	2101PC10116	R.PANDIYAN																		
47.	2101PC10117	MOHAMED SHEIK ABDULLAH.M																		
48.	2101PC10118	A.DHIVAKAR																		

2008 2009 2010 2011 2012 2013 2014 2015 2016 2017 2018 2019 2020 2021 2022 2023 2024 2025 2026 2027 2028 2029

S.NO	REG.NO	NAME	08.10.2023		09.10.2023		10.10.2023												
			2.30 to3.30pm	3.30 to 4.30 pm	2.30 to3.30pm	3.30 to 4.30 pm	2.30 to3.30pm	3.30 to 4.30 pm											
1.	2101PC10205	A.KEERTHANA	/	/	/	/	/	/											
2.	2101PC10206	S.ANJALI	/	/	/	/	/	/											
3.	2101PC10207	KALPANA.G	/	/	/	/	/	/											
4.	2101PC10208	RANYA.K	/	/	/	/	/	/											
5.	2101PC10209	YUVARANJANI.S	/	/	/	/	/	/											
6.	2101PC10210	JOHN PAUL.R	/	/	/	/	/	/											
7.	2101PC10211	DIVYA.A	/	/	/	/	/	/											
8.	2101PC10212	B.PRAVEENA	/	/	/	/	/	/											
9.	2101PC10213	B.ISHWARYA	/	/	/	/	/	/											
10.	2101PC10214	S.VARTHANI	/	/	/	/	/	/											
11.	2101PC10215	P.REBECCA	/	/	/	/	/	/											
12.	2101PC10216	B.PRIYADHARSHINI	/	/	/	/	/	/											
13.	2101PC10217	S.SOUNDHARYA	/	/	/	/	/	/											
14.	2101PC10218	B.ABINAYA	/	/	/	/	/	/											
15.	2101PC10219	A.SIVARANJANI	/	/	/	/	/	/											
16.	2101PC10220	A.KAVITHA	/	/	/	/	/	/											
17.	2101PC10221	C.AMIRTHA	/	/	/	/	/	/											
18.	2101PC10222	SNEHA.B	/	/	/	/	/	/											
19.	2101PC10223	A.N.SANDHIYA	/	/	/	/	/	/											
20.	2101PC10224	R.DHANUSIYA	/	/	/	/	/	/											
21.	2101PC10225	S.BAVATHARANI	/	/	/	/	/	/											
22.	2101PC10226	K.KANNIGA	/	/	/	/	/	/											
23.	2101PC10227	S.KAVIPRIYA	/	/	/	/	/	/											



PONNAIYAH RAMAJAYAM INSTITUTE OF SCIENCE & TECHNOLOGY (PRIST)

Declared as DEEMED-TO-BE-UNIVERSITY
U/s 3 of UGC Act, 1956

2023-2024 VALUE ADDED COURSE

(Certificate course on Lymphohaemopoietic system)

Enrolled student list

S.NO	REG NO	STUDENT LIST
1.	2101PC10205	A.KEERTHANA
2.	2101PC10206	S.ANJALI
3.	2101PC10207	KALPANA.G
4.	2101PC10208	RANYA .K
5.	2101PC10209	YUVARANJANI .S
6.	2101PC10210	JOHN PAUL R
7.	2101PC10211	DIVYA A
8.	2101PC10212	B.PRAVEENA
9.	2101PC10213	B.ISHWARYA
10.	2101PC10214	S.VARTHANI
11.	2101PC10215	P.REBECCA
12.	2101PC10216	B.PRIYADHARSHINI
13.	2101PC10217	S.SOUNDHARYA
14.	2101PC10218	B.ABINAYA
15.	2101PC10219	A.SIVARANJANI
16.	2101PC10220	A.KAVITHA
17.	2101PC10221	C.AMIRTHA
18.	2101PC10222	SNEHA.B
19.	2101PC10223	A.N.SANDHIYA
20.	2101PC10224	R.DHANUSIYA
21.	2101PC10225	S.BAVATHARANI
22.	2101PC10226	K.KANNIGA
23.	2101PC10227	S.KAVIPRIYA
24.	2101PC10228	M.SWETHA
25.	2101PC10229	S.DEEPIKA
26.	2101PC10230	DEEPALAKSHMI.V
27.	2101PC10231	R.RITHIKAA
28.	2101PC10232	K.INIYA
29.	2101PC10233	S.ANJALI
30.	2101PC10234	L.SUSMA
31.	2101PC10101	N.KARINA

32.	2101PC10102	T.YALINI
33.	2101PC10103	C.DEVI
34.	2101PC10104	M.SALIM
35.	2101PC10105	M.SANTHOSH
36.	2101PC10106	G.SIVAKANTHAN
37.	2101PC10107	P.KESAVAN
38.	2101PC10108	S.PRABAKARAN
39.	2101PC10109	M.ABDUL RAHIM
40.	2101PC10110	S.PRAVEEN
41.	2101PC10111	B.JUSTIN VISHNU
42.	2101PC10112	K.HARIHARAN
43.	2101PC10113	GOKUL S
44.	2101PC10114	P V NAVEEN
45.	2101PC10115	U.S.MOHAMED SHARIF
46.	2101PC10116	R.PANDIYAN
47.	2101PC10117	MOHAMED SHEIK ABDULLAH.M
48.	2101PC10118	A.DHIVAKAR

S. Suby

Head of the Department
Department of Biochemistry
School of Arts & Science
PRIST Deemed to be University
Thanjavur-613 403

Devi

DEAN
School of Arts & Science
Ponnaiyah Ramalingam
School of Arts & Science
Deemed to be University
Vellam, Thanjavur - 613 403



PONNAIYAH RAMAJAYAM INSTITUTE OF SCIENCE & TECHNOLOGY (PRIST)

Declared as DEEMED-TO-BE-UNIVERSITY
U/s 3 of UGC Act, 1956

VALUE ADDED COURSE (Certificate course on Lymphohaemopoietic system) TIME TABLE

S.NO	DATE	2.30-3.30 PM	3.30-4.30PM
1.	10.12.2023	DR.A.SUNDARESAN	DR.S.SATHISHKUMAR
2.	11.12.2023	DR.A.SUNDARESAN	DR.S.SATHISHKUMAR
3.	12.12.2023	DR.A.SUNDARESAN	DR.S.SATHISHKUMAR
4.	13.12.2023	DR.A.SUNDARESAN	DR.S.SATHISHKUMAR
5.	14.12.2023	DR.A.SUNDARESAN	DR.S.SATHISHKUMAR
6.	19.12.2023	DR.A.SUNDARESAN	DR.S.SATHISHKUMAR
7.	20.12.2023	DR.A.SUNDARESAN	DR.S.SATHISHKUMAR
8.	21.12.2023	DR.A.SUNDARESAN	DR.S.SATHISHKUMAR
9.	22.12.2023	DR.A.SUNDARESAN	DR.S.SATHISHKUMAR
10.	24.12.2023	DR.A.SUNDARESAN	DR.S.SATHISHKUMAR
11.	24.12.2023	DR.A.SUNDARESAN	DR.S.SATHISHKUMAR
12.	25.12.2023	DR.A.SUNDARESAN	DR.S.SATHISHKUMAR
13.	26.12.2023	DR.A.SUNDARESAN	DR.S.SATHISHKUMAR
14.	28.12.2023	DR.A.SUNDARESAN	DR.S.SATHISHKUMAR
15.	28.12.2023	DR.A.SUNDARESAN	DR.S.SATHISHKUMAR
16.	31.12.2023	DR.A.SUNDARESAN	DR.S.SATHISHKUMAR
17.	02.01.2024	DR.A.SUNDARESAN	DR.S.SATHISHKUMAR
18.	03.01.2024	DR.A.SUNDARESAN	DR.S.SATHISHKUMAR
19.	04.01.2024	DR.A.SUNDARESAN	DR.S.SATHISHKUMAR
20.	05.01.2024	DR.A.SUNDARESAN	DR.S.SATHISHKUMAR
21.	08.01.2024	DR.A.SUNDARESAN	DR.S.SATHISHKUMAR
22.	09.01.2024	DR.A.SUNDARESAN	DR.S.SATHISHKUMAR
23.	10.01.2024	DR.A.SUNDARESAN	DR.S.SATHISHKUMAR

A. M. J.

Head of the Department
Department of Biochemistry
School of Arts & Science
PRIST Deemed to be University
Thanjavur-613 403

S. Sathish Kumar

DEAN
School of Arts & Science
Ponnaiyah Ramajayam Institute of
Science & Technology (PRIST)
Deemed to be University
Vellam, Thanjavur - 613 403.



**PONNAIYAH RAMAJAYAM INSTITUTE OF
SCIENCE & TECHNOLOGY (PRIST)**

Declared as DEEMED-TO-BE UNIVERSITY
U/s 3 of UGC Act, 1956

CERTIFICATE COURSE ON LYMPHOHAEMATOLOGIC SYSTEM (23-24) STUDENT LIST

S.NO	REG.NO	NAME	10.12.2023		11.12.2023		12.12.2023		13.12.2023		14.12.2023		19.12.2023		20.12.2023		21.12.2023		22.12.2023		24.12.2023	
			2.30 to 3.30pm	3.30 to 4.30 pm	2.30 to 3.30pm	3.30 to 4.30 pm	2.30 to 3.30pm	3.30 to 4.30 pm	2.30 to 3.30pm	3.30 to 4.30 pm	2.30 to 3.30pm	3.30 to 4.30 pm	2.30 to 3.30pm	3.30 to 4.30 pm	2.30 to 3.30pm	3.30 to 4.30 pm	2.30 to 3.30pm	3.30 to 4.30 pm	2.30 to 3.30pm	3.30 to 4.30 pm	2.30 to 3.30pm	3.30 to 4.30 pm
1.	2101PC10205	A.KEERTHANA	/	/	/	/	/	/	/	/	/	/	/	/	/	/	/	/	/	/	/	/
2.	2101PC10206	S.ANJALI	/	/	/	/	/	/	/	/	/	/	/	/	/	/	/	/	/	/	/	/
3.	2101PC10207	KALPANA.G	/	/	/	/	/	/	/	/	/	/	/	/	/	/	/	/	/	/	/	/
4.	2101PC10208	RANYA.K	/	/	/	/	/	/	/	/	/	/	/	/	/	/	/	/	/	/	/	/
5.	2101PC10209	YUVARAJANI.S	/	/	/	/	/	/	/	/	/	/	/	/	/	/	/	/	/	/	/	/
6.	2101PC10210	JOHN PAUL.R	/	/	/	/	/	/	/	/	/	/	/	/	/	/	/	/	/	/	/	/
7.	2101PC10211	DIVYA.A	/	/	/	/	/	/	/	/	/	/	/	/	/	/	/	/	/	/	/	/
8.	2101PC10212	B.PRAVEENA	/	/	/	/	/	/	/	/	/	/	/	/	/	/	/	/	/	/	/	/
9.	2101PC10213	BISHWARYA	/	/	/	/	/	/	/	/	/	/	/	/	/	/	/	/	/	/	/	/
10.	2101PC10214	S.VARTHANI	/	/	/	/	/	/	/	/	/	/	/	/	/	/	/	/	/	/	/	/
11.	2101PC10215	P.REBECCA	/	/	/	/	/	/	/	/	/	/	/	/	/	/	/	/	/	/	/	/
12.	2101PC10216	B.PRIYADHARSHINI	/	/	/	/	/	/	/	/	/	/	/	/	/	/	/	/	/	/	/	/
13.	2101PC10217	S.SOUNDHARYA	/	/	/	/	/	/	/	/	/	/	/	/	/	/	/	/	/	/	/	/
14.	2101PC10218	B.ABINAYA	/	/	/	/	/	/	/	/	/	/	/	/	/	/	/	/	/	/	/	/
15.	2101PC10219	A.SIVARANJANI	/	/	/	/	/	/	/	/	/	/	/	/	/	/	/	/	/	/	/	/
16.	2101PC10220	A.KAVITHA	/	/	/	/	/	/	/	/	/	/	/	/	/	/	/	/	/	/	/	/

S.NO	REG.NO	NAME	24.12.2023		25.12.2023		26.12.2023		28.12.2023		29.12.2023		31.12.2023		02.01.2024		03.01.2024		04.01.2024		05.01.2024	
			2.30 to 3.30pm	3.30 to 4.30 pm	2.30 to 3.30pm	3.30 to 4.30 pm	2.30 to 3.30pm	3.30 to 4.30 pm	2.30 to 3.30pm	3.30 to 4.30 pm	2.30 to 3.30pm	3.30 to 4.30 pm	2.30 to 3.30pm	3.30 to 4.30 pm	2.30 to 3.30pm	3.30 to 4.30 pm	2.30 to 3.30pm	3.30 to 4.30 pm	2.30 to 3.30pm	3.30 to 4.30 pm	2.30 to 3.30pm	3.30 to 4.30 pm
1.	2101PC10205	A.KEERTHANA	A	A																		
2.	2101PC10206	S.ANJALI	/	/	/	/	/	/	/	/	/	/	/	/	/	/	/	/	/	/	/	/
3.	2101PC10207	KALPANA.G	/	/	/	/	/	/	/	/	/	/	/	/	/	/	/	/	/	/	/	/
4.	2101PC10208	RANYA.K	/	/	/	/	/	/	/	/	/	/	/	/	/	/	/	/	/	/	/	/
5.	2101PC10209	YUVARANJANI.S	/	/	/	/	/	/	/	/	/	/	/	/	/	/	/	/	/	/	/	/
6.	2101PC10210	JOHN PAUL R	/	/	A	A	/	/	/	/	/	/	/	/	/	/	/	/	/	/	/	/
7.	2101PC10211	DIVYA.A	/	/	/	/	/	/	/	/	/	/	/	/	/	/	/	/	/	/	/	/
8.	2101PC10212	B.PRAVEENA	/	/	/	/	/	/	/	/	/	/	/	/	/	/	/	/	/	/	/	/
9.	2101PC10213	B.ISHWARYA	/	/	/	/	/	/	/	/	/	/	/	/	/	/	/	/	/	/	/	/
10.	2101PC10214	S.VARTHANI	/	/	/	/	/	A	A	/	/	/	/	/	/	/	/	/	/	/	/	/
11.	2101PC10215	P.REBECCA	/	/	/	/	/	/	/	/	/	/	/	/	/	/	/	/	/	/	/	/
12.	2101PC10216	B.PRIYADHARSHINI	/	/	/	/	/	/	/	/	/	/	/	/	/	/	/	/	/	/	/	/
13.	2101PC10217	S.SOUNDHARYA	/	/	/	/	/	/	/	/	/	/	/	/	/	/	/	/	/	/	/	/
14.	2101PC10218	B.ABINAYA	/	/	/	/	/	/	/	/	/	/	/	/	/	/	/	/	/	/	/	/
15.	2101PC10219	A.SIVARANJANI	/	/	/	/	/	/	/	/	/	/	/	/	/	/	/	/	/	/	/	/
16.	2101PC10220	A.KAVITHA	/	/	/	/	/	/	/	A	A	/	/	/	/	/	/	/	/	/	/	/
17.	2101PC10221	C.AMIRTHA	/	/	/	/	/	/	/	/	/	/	/	/	/	/	/	/	/	/	/	/
18.	2101PC10222	SNEHA.B	/	/	/	/	/	/	/	/	/	/	/	/	/	/	/	/	/	/	/	/
19.	2101PC10223	A.N.SANDHYA	/	/	/	/	/	/	/	/	/	/	/	/	/	/	/	/	/	/	/	/
20.	2101PC10224	R.DHANUSIYA	/	/	/	/	/	/	/	/	/	/	/	/	/	/	/	/	/	/	/	/
21.	2101PC10225	S.BAVATHARANI	/	/	/	/	/	/	/	/	/	/	/	/	/	/	/	/	/	/	/	/
22.	2101PC10226	K.KANNIGA	/	/	/	/	/	/	/	/	/	/	/	/	/	/	/	/	/	/	/	/
23.	2101PC10227	S.KAVIPRIYA	/	/	/	/	/	/	/	/	/	/	/	/	/	/	/	/	/	/	/	/
24.	2101PC10228	M.SWETHA	/	/	/	/	/	/	/	/	/	/	/	/	/	/	/	/	/	/	/	/
25.	2101PC10229	S.DEEPIKA	/	/	/	/	/	/	/	/	/	/	/	/	/	/	/	/	/	/	/	/

S.NO	REG.NO	NAME	08.01.2024	09.01.2024	10.01.2024														
26	2101PC10230	DEEPALAKSHMLV	A	A	/	/	/	/	/	/	/	/	/	/	/	/	/	/	/
27	2101PC10231	R.RITHIKAA	/	/	/	/	/	/	/	/	/	/	/	/	/	/	/	/	/
28	2101PC10232	K.INIYA	/	/	/	/	/	/	/	/	/	/	/	/	/	/	/	/	/
29	2101PC10233	S.ANJALI	/	/	A	A	/	/	/	/	/	/	/	/	/	/	/	/	/
30	2101PC10234	L.SUSMA	/	/	/	/	/	/	/	/	/	/	/	/	/	/	/	/	/
31	2101PC10101	N.KARINA	/	/	/	/	/	/	/	/	/	/	/	/	/	/	/	/	/
32	2101PC10102	T.YALINI	/	/	/	/	/	/	/	/	/	/	/	/	/	/	/	/	/
33	2101PC10103	C.DEVI	/	/	/	/	/	/	/	/	/	/	/	/	/	/	/	/	/
34	2101PC10104	M.SALIM	/	/	/	/	/	/	/	/	/	/	/	/	/	/	/	/	/
35	2101PC10105	M.SANTHOSH	/	/	/	/	/	/	/	/	/	/	/	/	/	/	/	/	/
36	2101PC10106	G.SIVAKANTHAN	/	/	/	/	/	/	/	/	/	/	/	/	/	/	/	/	/
37	2101PC10107	P.KESAVAN	/	/	/	/	/	/	/	/	/	/	/	/	/	/	/	/	/
38	2101PC10108	S.PRABAKARAN	/	/	/	/	/	/	/	/	/	/	/	/	/	/	/	/	/
39	2101PC10109	M.ABDUL RAHIM	/	/	/	/	/	/	/	/	/	/	/	/	/	/	/	/	/
40	2101PC10110	S.PRAVEEN	/	/	/	/	/	/	/	/	/	/	/	/	/	/	/	/	/
41	2101PC10111	B.JUSTIN VISHNU	/	/	/	/	/	/	/	/	/	/	/	/	/	/	/	/	/
42	2101PC10112	K.HARIHARAN	/	A	A	/	/	/	/	/	/	/	/	/	/	/	/	/	/
43	2101PC10113	GOKUL S	/	/	A	A	/	/	/	/	/	/	/	/	/	/	/	/	/
44	2101PC10114	P.V.NAVEEN	/	/	/	/	/	/	/	/	/	/	/	/	/	/	/	/	/
45	2101PC10115	U.S.MOHAMED SHARIF	/	/	/	/	/	/	/	/	/	/	/	/	/	/	/	/	/
46	2101PC10116	R.PANDIYAN	/	/	/	/	/	/	A	A	/	/	/	/	/	/	/	/	/
47	2101PC10117	MOHAMED SHEIK ABDULLAH M	/	/	/	/	/	/	/	/	/	/	/	/	/	/	/	/	/
48	2101PC10118	A.DHIVAKAR	/	/	/	/	/	/	/	/	/	/	/	/	/	/	/	/	/

Handwritten notes in blue ink are present along the bottom of the table, including the word "PAPER" written vertically and other illegible scribbles.

1.	2101PC10205	A.KEERTHANA	A	2.30 to3.30pm	A	3.30 to 4.30 pm	A	2.30 to3.30pm	A	3.30 to 4.30 pm	A
2.	2101PC10206	S.ANJALI	/	/	/	/	/	/	/	/	/
3.	2101PC10207	KALPANA.G	/	/	/	/	/	/	/	/	/
4.	2101PC10208	RANYA.K	/	/	/	/	/	/	/	/	/
5.	2101PC10209	YUVARAJANI.S	/	/	/	/	A	/	/	/	/
6.	2101PC10210	JOHN PAUL R	/	/	/	/	/	/	/	/	/
7.	2101PC10211	DIVYA A	/	/	/	/	/	/	/	/	/
8.	2101PC10212	B.PRAVEENA	/	/	/	/	/	/	/	/	/
9.	2101PC10213	B.ISHWARYA	/	/	/	/	/	/	/	/	/
10.	2101PC10214	S.VARTHANI	/	/	/	/	/	/	/	/	/
11.	2101PC10215	P.REBECCA	/	/	/	/	/	/	/	/	/
12.	2101PC10216	B.PRIYADHARSHINI	/	/	/	/	A	/	/	/	/
13.	2101PC10217	S.SOUNDHARYA	A	A	/	/	/	/	/	/	/
14.	2101PC10218	B.ABINAYA	/	/	/	/	/	/	/	/	/
15.	2101PC10219	A.SIVARANJANI	/	/	/	/	/	/	/	/	/
16.	2101PC10220	A.KAVITHA	/	/	/	/	/	/	/	/	/
17.	2101PC10221	C.AMIRTHA	/	/	/	/	/	/	/	/	/
18.	2101PC10222	SNEHA B	/	/	/	/	/	/	/	/	/
19.	2101PC10223	A.N.SANDHYA	/	/	/	/	/	/	/	/	/
20.	2101PC10224	R.DHANUSIYA	/	/	/	/	/	/	/	/	/
21.	2101PC10225	S.BAVATHARANI	/	/	/	/	/	/	/	/	/
22.	2101PC10226	K.KANNIGA	/	/	/	/	/	/	/	/	/
23.	2101PC10227	S.KAVIRIYA	A	A	/	/	/	/	/	/	/
24.	2101PC10228	M.SWETHA	/	/	/	/	/	/	/	/	/
25.	2101PC10229	S.DEEPIKA	/	/	/	/	/	/	/	/	/
26.	2101PC10230	DEEPAI.AKSHMI.V	/	/	/	/	A	A	/	/	/
27.	2101PC10231	R.RITHIKAA	/	/	/	/	/	/	/	/	/
28.	2101PC10232	K.INIYA	/	/	/	/	/	/	/	/	/
29.	2101PC10233	S.ANJALI	/	/	/	/	/	/	/	/	/
30.	2101PC10234	L.SUSMA	/	/	/	/	A	A	/	/	/

8.01.24

9.1.24

10.1.24

31.	2101PC10101	N.KARINA	A	A	/	/	/	/	/	/	/	/	/	/	/	/	/	/	/
32.	2101PC10102	T.YALINI	/	/	/	/	/	/	/	/	/	/	/	/	/	/	/	/	/
33.	2101PC10103	C.DEVI	/	/	/	/	/	/	/	/	/	/	/	/	/	/	/	/	/
34.	2101PC10104	M.SALIM	/	/	/	/	/	/	/	/	/	/	/	/	/	/	/	/	/
35.	2101PC10105	M.SANTHOSH	/	/	/	/	/	/	/	/	/	/	/	/	/	/	/	/	/
36.	2101PC10106	G.SIVAKANTHAN	A	A	/	/	/	/	/	/	/	/	/	/	/	/	/	/	/
37.	2101PC10107	P.KESAVAN	/	/	/	/	/	/	/	/	/	/	/	/	/	/	/	/	/
38.	2101PC10108	S.PRABAKARAN	/	/	/	/	/	/	/	/	/	/	/	/	/	/	/	/	/
39.	2101PC10109	M.ABDUL RAHIM	/	/	/	/	/	/	/	/	/	/	/	/	/	/	/	/	/
40.	2101PC10110	S.PRAVEEN	/	/	/	/	/	/	/	/	/	/	/	/	/	/	/	/	/
41.	2101PC10111	B.JUSTIN VISHNU	/	/	/	/	/	/	/	/	/	/	/	/	/	/	/	/	/
42.	2101PC10112	K.HARIHARAN	/	/	/	/	/	/	/	/	/	/	/	/	/	/	/	/	/
43.	2101PC10113	GOKUL S	/	/	/	/	/	/	/	/	/	/	/	/	/	/	/	/	/
44.	2101PC10114	P.V.NAVEEN	/	/	/	/	/	/	/	/	/	/	/	/	/	/	/	/	/
45.	2101PC10115	U.S.MOHAMED SHARIF	A	A	/	/	/	/	/	/	/	/	/	/	/	/	/	/	/
46.	2101PC10116	R.PANDIYAN	/	/	/	/	/	/	/	/	/	/	/	/	/	/	/	/	/
47.	2101PC10117	MOHAMED SHEIK ABDULLAH M	/	/	/	/	/	/	/	/	/	/	/	/	/	/	/	/	/
48.	2101PC10118	A.DHIVAKAR	/	/	/	/	/	/	/	/	/	/	/	/	/	/	/	/	/

[Handwritten signature]

Head of the Department
 Department of Biochemistry
 School of Arts & Sciences
 PGST Deemed to be University
 Thiruvananthapuram - 695 009

[Handwritten signature]

[Handwritten signature]

DEAN
 School of Arts & Sciences
 Ponnambal, Ponnambal
 Science & Technology
 Deemed to be University
 Willem, Thiruvananthapuram - 695 009.



PONNAIYAH RAMAJAYAM INSTITUTE OF SCIENCE & TECHNOLOGY (PRIST)

Declared as DEEMED-TO-BE-UNIVERSITY
U/s 3 of UGC Act, 1956

2023-2024

VALUE ADDED COURSE (VERMICOMPOST)

Enrolled student list

S.NO	REG NO	STUDENT LIST
1.	2301PC20102	N.SIVA
2.	2301PC20103	M.ARUN
3.	2301PC20104	C.SUMAN
4.	2301PC20105	A.SANJAI
5.	2301PC20106	G.GOPALAKRISHNAN
6.	2301PC20107	K.HARISH
7.	2301PC20108	D.LOKESH
8.	2301PC20109	A.SATHISH
9.	2301PC20110	G.KATHIRAVAN
10.	2301PC20111	G.DEVADHARSHAN
11.	2301PC20112	B.SRIDHAR
12.	2301PC20201	B.PAVITHRA
13.	2301PC20202	S.APARNA
14.	2301PC20203	M.RIYA
15.	2301PC20204	S.RESMA
16.	2301PC20205	I.AFSANA
17.	2301PC20206	M.PRIYANKA
18.	2301PC20207	B.PRIYA
19.	2301PC20208	L.SUSMITHA
20.	2301PC20209	V.ARUNA
21.	2301PC20210	M.KANMANI
22.	2301PC20211	S.LAKSHMI
23.	2201PC20101	R.KAVIN
24.	2201PC20102	S.SUMAN
25.	2201PC20103	A.ARAVIND
26.	2201PC20104	T.ARUN
27.	2201PC20105	K.KALYAN
28.	2201PC20106	F.ABDUAL
29.	2201PC20107	S.AMIR
30.	2201PC20108	J.SUKUMAR

Head of the Department
Department of Biochemistry
School of Arts & Science
PRIST Deemed to be University
Thanjavur-613 403

DEAN
School of Arts & Science
Ponnaiyah Ramajayam Institute of
Science & Technology (PRIST)
Deemed to be University
Thanjavur - 613 403

31.	2201PC20109	R.JEYANTH
32.	2201PC20110	L.KAVIMANI
33.	2201PC20201	R.OVIYA
34.	2201PC20202	T.LAKSHMI
35.	2201PC20203	S.SUGANTHI
36.	2201PC20204	K.PARIMALA
37.	2201PC20205	K.SUGUNA
38.	2201PC20206	S.PRIYADHARSHINI
39.	2201PC20207	R.ROSHINI
40.	2201PC20208	B.NIRMALA
41.	2201PC20209	A.GAYATHRI
42.	2201PC20210	N.SOFIYA

 Head of the Department
 Department of Biochemistry
 School of Arts & Science
 PRIST Deemed to be University
 Thanjavur-613 403

 DEAN
 School of Arts & Science
 Ponnayiah Ramaswamy Institute of
 Science & Technology (PRIST)
 Deemed to be University
 Vellam, Thanjavur - 613 403.





PONNAIYAH RAMAJAYAM INSTITUTE OF SCIENCE & TECHNOLOGY (PRIST)

Declared as DEEMED-TO-BE-UNIVERSITY
U/s 3 of UGC Act, 1956

VALUE ADDED COURSE (Certificate course on Vermicompost) TIME TABLE

S.NO	DATE	2.30-3.30 PM	3.30-4.30PM
1.	10.02.2024	DR.A.SUNDARESAN	DR.SATHISHKUMAR
2.	11.02.2024	DR.A.SUNDARESAN	DR.SATHISHKUMAR
3.	12.02.2024	DR.A.SUNDARESAN	DR.SATHISHKUMAR
4.	13.02.2024	DR.A.SUNDARESAN	DR.SATHISHKUMAR
5.	14.02.2024	DR.A.SUNDARESAN	DR.SATHISHKUMAR
6.	19.02.2024	DR.A.SUNDARESAN	DR.SATHISHKUMAR
7.	20.02.2024	DR.A.SUNDARESAN	DR.SATHISHKUMAR
8.	21.02.2024	DR.A.SUNDARESAN	DR.SATHISHKUMAR
9.	22.02.2024	DR.A.SUNDARESAN	DR.SATHISHKUMAR
10.	24.02.2024	DR.A.SUNDARESAN	DR.SATHISHKUMAR
11.	25.02.2024	DR.A.SUNDARESAN	DR.SATHISHKUMAR
12.	25.02.2024	DR.A.SUNDARESAN	DR.SATHISHKUMAR
13.	26.02.2024	DR.A.SUNDARESAN	DR.SATHISHKUMAR
14.	28.02.2024	DR.A.SUNDARESAN	DR.SATHISHKUMAR
15.	02.03.2024	DR.A.SUNDARESAN	DR.SATHISHKUMAR
16.	03.03.2024	DR.A.SUNDARESAN	DR.SATHISHKUMAR
17.	05.03.2024	DR.A.SUNDARESAN	DR.SATHISHKUMAR
18.	07.03.2024	DR.A.SUNDARESAN	DR.SATHISHKUMAR
19.	11.03.2024	DR.A.SUNDARESAN	DR.SATHISHKUMAR
20.	12.03.2024	DR.A.SUNDARESAN	DR.SATHISHKUMAR
21.	16.03.2024	DR.A.SUNDARESAN	DR.SATHISHKUMAR
22.	21.03.2024	DR.A.SUNDARESAN	DR.SATHISHKUMAR
23.	24.03.2024	DR.A.SUNDARESAN	DR.SATHISHKUMAR

Head of the Department
Department of Biochemistry
School of Arts & Science
PRIST Deemed to be University
Thanjavur-613 403

DEAN
School of Arts & Science
Ponnaiyah Ramajayam Institute
Science & Technology (PRIST)
Deemed to be University
Vellam, Thanjavur - 613 403.



**PONNAIYAH RAMAJAYAM INSTITUTE OF
SCIENCE & TECHNOLOGY (PRIST)**

Declared as DEEMED TO BE UNIVERSITY
U/s 3 of UGC Act, 1956

CERTIFICATE COURSE ON VERMICOMPOST (23-24) STUDENT LIST

NO	REG.NO	NAME	10.02.2024		11.02.2024		12.02.2024		13.02.2024		14.02.2024		19.02.2024		20.02.2024		21.02.2024		22.02.2024		24.02.2024	
			2.30 to3.30pm	3.30 to 4.30 pm	2.30 to3.30pm	3.30 to 4.30 pm	2.30 to3.30pm	3.30 to 4.30 pm	2.30 to3.30pm	3.30 to 4.30 pm	2.30 to3.30pm	3.30 to 4.30 pm	2.30 to3.30pm	3.30 to 4.30 pm	2.30 to3.30pm	3.30 to 4.30 pm	2.30 to3.30pm	3.30 to 4.30 pm	2.30 to3.30pm	3.30 to 4.30 pm		
1.	2301PC20102	N.SIVA	X	X	X	X	X	X	X	X	X	X	X	X	X	X	X	X	X	X	X	X
2.	2301PC20103	M.MARUN	X	X	X	X	X	X	X	X	X	X	X	X	X	X	X	X	X	X	X	X
3.	2301PC20104	C.SUMAN	X	X	X	X	X	X	X	X	X	X	X	X	X	X	X	X	X	X	X	X
4.	2301PC20105	A.SANJAI	X	X	X	X	X	X	X	X	X	X	X	X	X	X	X	X	X	X	X	X
5.	2301PC20106	G.GOPALAKRISHNAN	X	X	X	X	X	X	X	X	X	X	X	X	X	X	X	X	X	X	X	X
6.	2301PC20107	K.HARISH	X	X	X	X	X	X	X	X	X	X	X	X	X	X	X	X	X	X	X	X
7.	2301PC20108	D.LOKESH	X	X	X	X	X	X	X	X	X	X	X	X	X	X	X	X	X	X	X	X
8.	2301PC20109	A.SATHISH	X	X	X	X	X	X	X	X	X	X	X	X	X	X	X	X	X	X	X	X
9.	2301PC20110	G.KATHIRAVAN	X	X	X	X	X	X	X	X	X	X	X	X	X	X	X	X	X	X	X	X
10	2301PC20111	G.DEVADHARSHAN	X	X	X	X	X	X	X	X	X	X	X	X	X	X	X	X	X	X	X	X
11	2301PC20112	B.SRIDHAR	X	X	X	X	X	X	X	X	X	X	X	X	X	X	X	X	X	X	X	X
12	2301PC20201	B.PAVITHRA	X	X	X	X	X	X	X	X	X	X	X	X	X	X	X	X	X	X	X	X
13	2301PC20202	S.APARNA	X	X	X	X	X	X	X	X	X	X	X	X	X	X	X	X	X	X	X	X

S.NO	REG.NO	NAME		
1.	2301PC20102	N.SIVA	2.30 to3.30pm	25.02.2024
2.	2301PC20103	M.ARUN	3.30 to 4.30 pm	
3.	2301PC20104	C.SUMAN	2.30 to3.30pm	26.02.2024
4.	2301PC20105	A.SANJAI	3.30 to 4.30 pm	
5.	2301PC20106	G.GOPALAKRISHNAN	2.30 to3.30pm	28.02.2024
6.	2301PC20107	K.HARISH	3.30 to 4.30 pm	
7.	2301PC20108	D.LOKESH	2.30 to3.30pm	02.03.2024
8.	2301PC20109	A.SATHISH	3.30 to 4.30 pm	
9.	2301PC20110	G.KATHIRAVAN	2.30 to3.30pm	03.03.2024
10.	2301PC20111	G.DEVADHARSHAN	3.30 to 4.30 pm	
11.	2301PC20112	B.SRIDHAR	2.30 to3.30pm	05.03.2024
12.	2301PC20201	B.PAVITHRA	3.30 to 4.30 pm	
13.	2301PC20202	S.APARNA	2.30 to3.30pm	07.03.2024
14.	2301PC20203	M.RIYA	3.30 to 4.30 pm	
15.	2301PC20204	S.REEMA	2.30 to3.30pm	11.03.2024
16.	2301PC20205	L.AFSANA	3.30 to 4.30 pm	
17.	2301PC20206	M.PRIYANKA	2.30 to3.30pm	12.03.2024
18.	2301PC20207	B.PRIYA	3.30 to 4.30 pm	
19.	2301PC20208	L.SUSMITHA	2.30 to3.30pm	15.03.2024
20.	2301PC20209	V.ARUNA	3.30 to 4.30 pm	
21.	2301PC20210	M.KANMANI	2.30 to3.30pm	
			3.30 to 4.30 pm	

22	2301PC20211	S.LAKSHMI	/	/	/	/	/	/	/	/	/	/	/	/	/	/	/	/	/	/	/	/
23	2201PC20101	R.KAVIN	/	/	/	/	/	/	/	/	/	/	/	/	/	/	/	/	/	/	/	/
24	2201PC20102	S.SUMAN	/	/	/	/	/	/	/	/	/	/	/	/	/	/	/	/	/	/	/	/
25	2201PC20103	A.ARAVIND	/	/	/	/	/	/	/	/	/	/	/	/	/	/	/	/	/	/	/	/
26	2201PC20104	T.ARUN	/	/	/	A	/	/	/	/	/	/	/	/	/	/	/	/	/	/	/	/
27	2201PC20105	K.KALYAN	/	/	/	/	/	/	/	/	/	/	/	/	/	/	/	/	/	/	/	/
28	2201PC20106	F.ABDUAL	/	/	/	/	/	/	/	/	/	/	/	/	/	/	/	/	/	/	/	/
29	2201PC20107	S.AMIIR	/	/	/	/	/	/	/	/	/	/	/	/	/	/	/	/	/	/	/	/
30	2201PC20108	J.SUKUMAR	/	/	/	/	/	/	/	/	/	/	/	/	/	/	/	/	/	/	/	/
31	2201PC20109	R.JEYANTH	/	/	/	/	/	/	/	A	/	/	/	/	/	/	/	/	/	/	/	/
32	2201PC20110	L.KAVIMANI	/	/	/	/	/	/	/	/	/	/	/	/	/	/	/	/	/	/	/	/
33	2201PC20201	R.OVIYA	/	/	/	/	/	/	/	/	/	/	/	/	/	/	/	/	/	/	/	/
34	2201PC20202	T.LAKSHMI	/	/	/	/	/	/	/	/	/	/	/	/	/	/	/	/	/	/	/	/
35	2201PC20203	S.SUGANTHI	/	/	/	/	/	/	/	/	/	/	/	/	/	/	/	/	/	/	/	/
36	2201PC20204	K.PARIMALA	/	/	/	/	/	/	/	/	/	/	/	/	/	/	/	/	/	/	/	/
37	2201PC20205	K.SUGUNA	/	/	/	A	/	/	/	/	/	/	/	/	/	/	/	/	/	/	/	/
38	2201PC20206	S.PRIYADHARSHINI	/	/	/	/	/	/	/	/	/	/	/	/	/	/	/	/	/	/	/	/
39	2201PC20207	R.ROSHINI	/	/	/	/	/	/	/	/	/	/	/	/	/	/	/	/	/	/	/	/
40	2201PC20208	B.NIRMALA	/	/	/	/	/	/	/	/	/	/	/	/	/	/	/	/	/	/	/	/
41	2201PC20209	A.GAYATHRI	/	/	/	/	/	/	/	/	/	/	/	/	/	/	/	/	/	/	A	/
42	2201PC20210	N.SOFIYA	/	/	/	/	/	/	/	/	/	/	/	/	/	/	/	/	/	/	/	/

Ashif

Head of the Department
Department of Biochemistry
School of Arts & Science
PRIST Deemed to be University
Thanjavur-613 403

Princy

DEAN
School of Arts & Science
Ponmalyath Ramalingam Institute of
Science & Technology (PRIST)
Deemed to be University
Veeram, Thanjavur - 613 403.

S.NO	REG.NO	NAME	16.03.2024		21.03.2024		24.03.2024																			
			2.30 to 3.30pm	3.30 to 4.30 pm	2.30 to 3.30pm	3.30 to 4.30 pm	2.30 to 3.30pm	3.30 to 4.30 pm																		
1.	2301PC20102	N.SIVA	/	/	/	/	/	/	/	/	/	/	/	/	/	/	/	/	/	/	/	/	/	/	/	
2.	2301PC20103	M.ARUN	/	/	/	/	/	/	/	/	/	/	/	/	/	/	/	/	/	/	/	/	/	/	/	/
3.	2301PC20104	C.SUMAN	/	/	/	/	/	/	/	/	/	/	/	/	/	/	/	/	/	/	/	/	/	/	/	/
4.	2301PC20105	A.SANJAI	/	/	/	/	/	/	/	/	/	/	/	/	/	/	/	/	/	/	/	/	/	/	/	/
5.	2301PC20106	G.GOPALAKRISHNAN	/	/	/	/	/	/	/	/	/	/	/	/	/	/	/	/	/	/	/	/	/	/	/	/
6.	2301PC20107	K.HARISH	/	/	/	/	/	/	/	/	/	/	/	/	/	/	/	/	/	/	/	/	/	/	/	/
7.	2301PC20108	D.LOKESH	/	/	/	/	/	/	/	/	/	/	/	/	/	/	/	/	/	/	/	/	/	/	/	/
8.	2301PC20109	A.SATHISH	/	/	/	/	/	/	/	/	/	/	/	/	/	/	/	/	/	/	/	/	/	/	/	/
9.	2301PC20110	G.KATHIRAVAN	/	/	/	/	/	/	/	/	/	/	/	/	/	/	/	/	/	/	/	/	/	/	/	/
10.	2301PC20111	G.DEVADHARSHAN	/	/	/	/	/	/	/	/	/	/	/	/	/	/	/	/	/	/	/	/	/	/	/	/
11.	2301PC20112	B.SRIDHAR	/	/	/	/	/	/	/	/	/	/	/	/	/	/	/	/	/	/	/	/	/	/	/	/
12.	2301PC20201	B.PAVITHRA	/	/	/	/	/	/	/	/	/	/	/	/	/	/	/	/	/	/	/	/	/	/	/	/
13.	2301PC20202	S.APARNA	/	/	/	/	/	/	/	/	/	/	/	/	/	/	/	/	/	/	/	/	/	/	/	/
14.	2301PC20203	M.RIYA	/	/	/	/	/	/	/	/	/	/	/	/	/	/	/	/	/	/	/	/	/	/	/	/
15.	2301PC20204	S.RESMA	/	/	/	/	/	/	/	/	/	/	/	/	/	/	/	/	/	/	/	/	/	/	/	/
16.	2301PC20205	L.AFSANA	/	/	/	/	/	/	/	/	/	/	/	/	/	/	/	/	/	/	/	/	/	/	/	/
17.	2301PC20206	M.PRIYANKA	/	/	/	/	/	/	/	/	/	/	/	/	/	/	/	/	/	/	/	/	/	/	/	/
18.	2301PC20207	B.PRIYA	/	/	/	/	/	/	/	/	/	/	/	/	/	/	/	/	/	/	/	/	/	/	/	/
19.	2301PC20208	L.SUSMITHA	/	/	/	/	/	/	/	/	/	/	/	/	/	/	/	/	/	/	/	/	/	/	/	/
20.	2301PC20209	V.ARUNA	/	/	/	/	/	/	/	/	/	/	/	/	/	/	/	/	/	/	/	/	/	/	/	/
21.	2301PC20210	M.KANMANI	/	/	/	/	/	/	/	/	/	/	/	/	/	/	/	/	/	/	/	/	/	/	/	/
22.	2301PC20211	S.LAKSHMI	/	/	/	/	/	/	/	/	/	/	/	/	/	/	/	/	/	/	/	/	/	/	/	/

23.	2201PC20101	R.KAVIN	/	/	/	/	/	/	/	/	/	/	/	/	/	/	/	/	/	/	/
24.	2201PC20102	S.SUMAN	/	/	/	/	/	/	/	/	/	/	/	/	/	/	/	/	/	/	/
25.	2201PC20103	A.ARAVINND	/	/	/	/	/	/	/	/	/	/	/	/	/	/	/	/	/	/	/
26.	2201PC20104	T.ARUN	/	/	/	/	/	/	/	/	/	/	/	/	/	/	/	/	/	/	/
27.	2201PC20105	K.KALYAN	/	/	/	/	/	/	/	/	/	/	/	/	/	/	/	/	/	/	/
28.	2201PC20106	F.ABDUAL	/	/	/	/	/	/	/	/	/	/	/	/	/	/	/	/	/	/	/
29.	2201PC20107	S.AMIR	/	/	/	/	/	/	/	/	/	/	/	/	/	/	/	/	/	/	/
30.	2201PC20108	J.SUKUMAR	/	/	/	/	/	/	/	/	/	/	/	/	/	/	/	/	/	/	/
31.	2201PC20109	R.JEYANTH	/	/	/	/	/	/	/	/	/	/	/	/	/	/	/	/	/	/	/
32.	2201PC20110	L.KAVIMANI	/	/	/	/	/	/	/	/	/	/	/	/	/	/	/	/	/	/	/
33.	2201PC20201	R.OVIYA	/	/	/	/	/	/	/	/	/	/	/	/	/	/	/	/	/	/	/
34.	2201PC20202	T.LAKSHMI	/	/	/	/	/	/	/	/	/	/	/	/	/	/	/	/	/	/	/
35.	2201PC20203	S.SUGANTHI	/	/	/	/	/	/	/	/	/	/	/	/	/	/	/	/	/	/	/
36.	2201PC20204	K.PARIMALA	/	/	/	/	/	/	/	/	/	/	/	/	/	/	/	/	/	/	/
37.	2201PC20205	K.SUGUNA	/	/	/	/	/	/	/	/	/	/	/	/	/	/	/	/	/	/	/
38.	2201PC20206	S.PRIYADHARSHINI	/	/	/	/	/	/	/	/	/	/	/	/	/	/	/	/	/	/	/
39.	2201PC20207	R.ROSHINI	/	/	/	/	/	/	/	/	/	/	/	/	/	/	/	/	/	/	/
40.	2201PC20208	B.NIRMALA	/	/	/	/	/	/	/	/	/	/	/	/	/	/	/	/	/	/	/
41.	2201PC20209	A.GAYATHRI	/	/	/	/	/	/	/	/	/	/	/	/	/	/	/	/	/	/	/
42.	2201PC20210	N.SOFIYA	/	/	/	/	/	/	/	/	/	/	/	/	/	/	/	/	/	/	/

[Handwritten signature in green ink]

Head of the Department
Department of Biochemistry
School of Arts & Science
PRIEST Deemed to be University
Thanjavur-613 403

[Handwritten signature in green ink]

DEAN
School of Arts & Science
Ponnaiyah Ramalingam Institute of
Science & Technology (PRIEST)
Deemed to be University
Velam, Thanjavur - 613 403.



PONNAIYAH RAMAJAYAM INSTITUTE OF
SCIENCE & TECHNOLOGY (PRIST)

Declared as DEEMED TO BE UNIVERSITY
Via 3 of UGC Act, 1956

SCHOOL OF ARTS AND SCIENCE

Department of Biochemistry

VALUE ADDED COURSE

Certificated Appreciation

This is to certify that Ms/ Mr B. Ayyappa:

Reg.No. 2301PC10101 has completed the Value

Added Course on Diploma course ON

Organic Farming, from 10.07.2023
to 09.09.2023, during the Academic year of 2023 to

2024

COURSE COORDINATOR

HOD

DEAN



PONNAIYAH RAMAJAYAM INSTITUTE OF
SCIENCE & TECHNOLOGY (PRIST)

Declared as DEEMED TO BE UNIVERSITY
U/s 3 of UGC Act, 1956

SCHOOL OF ARTS AND SCIENCE

Department of Biochemistry
VALUE ADDED COURSE

Certificated Appreciation

This is to certify that Ms/ Mr A: Keerthana

Reg.No. 21BA.PC10205 has completed the Value

Added Course on Certificate Course on Telerummary

Digital System from 10.09.2023

to 10.10.2023 during the Academic year of 2023 to
2024

COURSE COORDINATOR

HOD

DEAN



PONNAIYAH RAMAJAYAM INSTITUTE OF
SCIENCE & TECHNOLOGY (PRIST)

Deemed as DEEMED TO BE UNIVERSITY
U.S. 3 of 00C Act, 1956

SCHOOL OF ARTS AND SCIENCE

Department of Biochemistry
VALUE ADDED COURSE

Certificated Appreciation

This is to certify that Ms/ Mr DR. ANITALL

Reg.No. 2101PC10206 has completed the Value

Added Course on Certificated course on

Lymphobacteroid peritric system from 10.12.2023

to 10.01.24 during the Academic year of 2023 to
2024

COURSE COORDINATOR

HOD

DEAN



PONNAIYAH RAMAJAYAM INSTITUTE OF
SCIENCE & TECHNOLOGY (PRIST)

Declared as DEEMED TO BE UNIVERSITY
U/S 3 of HIG Act, 1956

SCHOOL OF ARTS AND SCIENCE

Department of Biochemistry
VALUE ADDED COURSE

Certificated Appreciation

This is to certify that Ms/Mr B. Pavithra

Reg.No. 2301PCC2021 has completed the Value

Added Course on Certificate Course on

Yearmicropost from 10.02.2024

to 24.03.2024 during the Academic year of 2023 to
2024

COURSE COORDINATOR

HOD

DEAN



PONNAIYAH RAMAJAYAM INSTITUTE OF
SCIENCE & TECHNOLOGY (PRIST)

Declared as DEEMED TO BE UNIVERSITY
U/a 3 of UGC Act, 1956

SCHOOL OF ARTS AND SCIENCE

Department of Biochemistry
VALUE ADDED COURSE

Certificate of Appreciation

This is to certify that Ms/Mr Karthika C
Reg.No. 2201PC10201 has completed the Value
Added Course on Certificate course on Techniques
in Biochemistry from 10.08.23
to 10.09.23 during the Academic year of 2023 to
2024

COURSE COORDINATOR

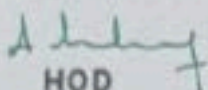
HOD

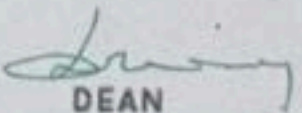
DEAN



**PONNAIYAH RAMAJAYAM INSTITUTE OF
SCIENCE & TECHNOLOGY (PRIST)**

Declared as DEEMED TO BE UNIVERSITY
U/s 3 of UGC Act, 1956

SCHOOL OF ENGINEERING & TECHNOLOGY

DEPARTMENT OF ELECTRICAL & ELECTRONICS ENGINEERING

PRIST/PO(A)23-24/06

DATE : 02.06.2023

CIRCULAR

SUB: ADD ON COURSE -REWINDING OF INDUCTION MOTOR- Reg

It is informed that employability/ entrepreneurship/ skill development training will be started on 12.06.2023 – 14.08.2023 for the academic year 2023-2024. The detailed schedule will be given by the departments.

Heads of the departments are requested to inform their students about the skill development training and motivate them to participate the training classes.

HOD'S are also requested to nominate one faculty member to co-ordinate the training class.

Head of the Department
Electrical and Electronics Engineering
Ponnaiyah Ramajayam Institute of
Science & Technology (PRIST)
(Institution Deemed to be University
U/s 3 of the UGC Act, 1956)
THANJAVUR - 613 403, TAMIL NADU

Copy to:

- The Hon'ble Chairman Sir
- HOD'S for necessary action
- Notice Board
- File

DEAN
DEAN
School of Engineering and Tech.
Ponnaiyah Ramajayam Institute of
Science and Technology (PRIST)
Deemed to be University
Vaitam, Thanjavur - 613 403.



PRIST
DEPT
UNIVERSITY
NAAC A+ (2015)
THANJAVUR - 613 403 - TAMIL NADU

SCHOOL OF ENGINEERING AND
TECHNOLOGY

DEPARTMENT OF ELECTRICAL AND
ELECTRONICS ENGINEERING

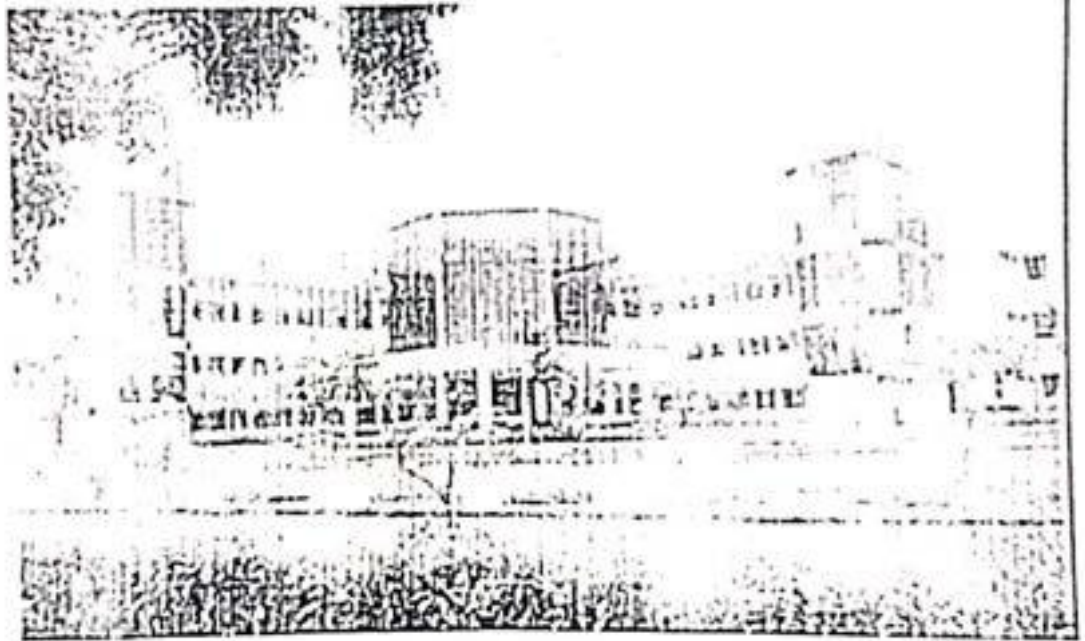

INFORMATION BROCHURE

VALUE ADDED COURSE- WINDING
OF INDUCTION MOTOR

Head of the Department
Electrical and Electronics Engineering
Ponnalyah Ramajayam Institute of
Science & Technology (PRIST)
Institution Deemed to be University
U/s 3 of the UGC Act, 1956
THANJAVUR - 613 403, TAMIL NADU

DEAN
School of Engineering and Tech,
Ponnalyah Ramajayam Institute of
Science and Technology (PRIST)
Deemed to be University
Veerathi, Thanjavur - 613 403.

ABOUT THE INSTITUTION

Ponnaiyah Ramajayam Institute of Science and Technology (PRIST), a Deemed University (U/s 3 of the UGC Act 1956), is one of the renowned units of Ponnaiyah Ramajayam Institutions, which are serving for more than 25 years promoting quality education and research for our Indian community, since its inception. The institution is now brimming with many social responsibilities, particularly in promoting quality education through research.

ABOUT THE DEPARTMENT

The Department of Electrical and Electronics of PRIST DEEMED UNIVERSITY was established in 2008. Since then its excellence in each and every aspect has played an important role in the institute. The department received university status under section 3 of UGC Act 1956.

The EEE Department is dedicated to delivering competent electrical engineers to the arena of the real world. They are outfitted with core technical knowledge as well as professional skills necessary to face the challenges of the future. The committed faculty and staff are fully geared up towards this end.

The department has spacious laboratories such as Machines lab, Electric Circuits Lab, Measurement and Instrumentation Lab, Control System Lab, Power Electronics Lab and Power systems Simulation Lab. All the laboratories are fully equipped with latest, modern and sophisticated equipments.

The Department has young as well as experienced and dynamic personalities as faculty, is involved in providing quality education at both Undergraduate (UG) and Postgraduate (PG) levels. The staffs are from various disciplines in masters like Power electronics and drives, Power system, advanced communication system. Many of the staff members are encouraged to pursue their higher studies and research works.

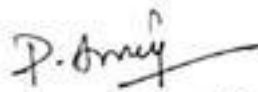

Head of the Department
Electrical and Electronics Engineering
Ponnaiyah Ramajayam Institute of
Science & Technology (PRIST)
Institution Deemed to be University
U/s 3 of the UGC Act, 1956
THANJAVUR - 613 403, TAMIL NADU



DEAN
School of Engineering and Tech.
Ponnaiyah Ramajayam Institute of
Science and Technology (PRIST)
Deemed to be University
Vandavasi, Thanjavur - 613 403

WINDING OF INDUCTION MOTOR

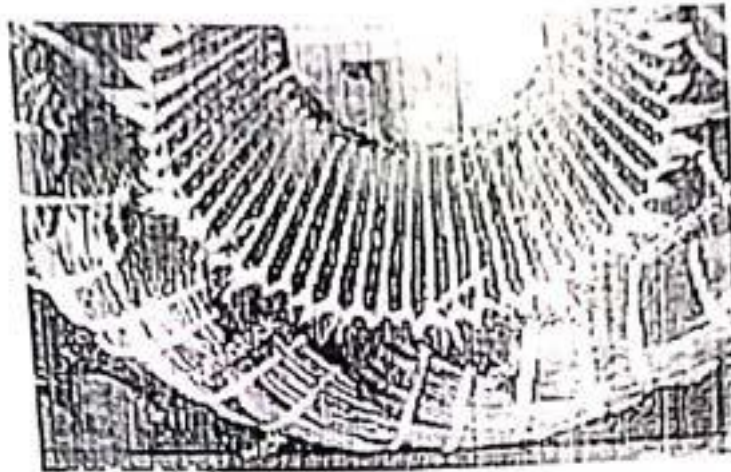

LEARNING OBJECTIVE

An Induction motor or Asynchronous motor is an AC electric motor in which the electric current in the rotor that produces torque is obtained by electromagnetic induction from the magnetic field of the stator winding. An induction motor therefore needs no electrical connections to the rotor. An induction motor's rotor can be either wound type or squirrel-cage type.

Three-phase squirrel-cage induction motors are widely used as industrial drives because they are self-starting, reliable, and economical. Single-phase induction motors are used extensively for smaller loads, such as garbage disposals and stationary power tools. Although traditionally used for constant-speed service, single- and three-phase induction motors are increasingly being installed in variable-speed applications using variable-frequency drives (VFD). VFD offers energy savings opportunities for induction motors in applications like fans, pumps, and compressors that have a variable load.

Head of the Department
Electrical and Electronics Engineering
Ponnaiyah Ramajayam Institute of
Science & Technology (PRIST)
Institution Deemed to be University
U's 3 of the UGC Act, 1956
THANJAVUR - 613 403, TAMIL NADU

DEAN
School of Engineering and Tech.
Ponnaiyah Ramajayam Institute of
Science and Technology (PRIST)
Deemed to be University
Thanjavur, Thanjavur-613 403.

Outcome:

- Apply the knowledge of basic principles and construction of AC machines for various industrial and house hold applications.
- Analyze the characteristics and performance of AC machines for a suitable application.
- Evaluate the performance of any AC machine for different loading conditions.
- Develop the equivalent circuit and phasor diagrams of any AC machine.

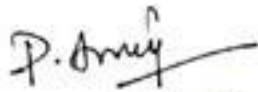

Head of the Department
Electrical and Electronics Engineering
Ponnaiyah Ramajayam Institute of
Science & Technology (PRIST)
Institution Deemed to be University
U/s 3 of the UGC Act, 1956)
THANJAVUR - 613 403, TAMIL NADU



DEAN
School of Engineering and Tech.
Ponnaiyah Ramajayam Institute of
Science and Technology (PRIST)
Deemed to be University
Thanjavur, Thanjavur - 613 403.

SYLLABUS

UNIT I:

3-Phase INDUCTION MOTORS: Polyphase induction motors-construction details of cage and wound rotor machines-production of a rotating magnetic field - principle of operation - rotor emf and rotor frequency - rotor reactance, rotor current and pf at standstill and during operation. Rotor power input, rotor copper loss and mechanical power developed and their inter relation-torque equation-deduction from torque equation - expressions for maximum torque and starting torque - torque slip characteristic - double cage and deep bar rotors - equivalent circuit - phasor diagram - crawling and cogging

UNIT II:

CIRCLE DIAGRAM & SPEED CONTROL METHODS OF INDUCTION MOTORS: Circle diagram no load and blocked rotor tests-predetermination of performance-methods of starting and starting current and torque calculations. Speed control-change of frequency; change of poles and methods of consequent poles; cascade connection. Injection of an emf into rotor circuit (qualitative treatment only)-induction generator-principle of operation.

UNIT III:

CONSTRUCTION AND PRINCIPLE OF OPERATION OF ALTERNATORS: Constructional Features of round rotor and salient pole machines, Armature windings, Integral slot and fractional slot windings; Distributed and concentrated windings, pitch and winding factors E.M.F Equation. Synchronous Generator Characteristics, Harmonics in generated E.M.F., suppression of harmonics, armature reaction, leakage reactance, synchrono.

UNIT IV:

SYNCHRONOUS MOTORS: Theory of operation, phasor diagram, Variation of current and power factor with excitation, synchronous condenser, Mathematical analysis for power developed.

UNIT V:

SINGLE PHASE MOTORS: Single phase induction motor, Constructional features-Double revolving field theory - Elementary idea of cross-field theory, splitphase motors, shaded pole motor. SPECIAL MOTORS: Principle & performance of A.C. Series motor, Universal motor. Principle of permanent magnet machines, stepper motors.

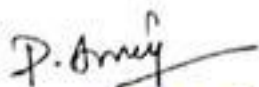

Head of the Department
Electrical and Electronics Engineering
Ponnalyah Ramajayam Institute of
Science & Technology (PRIST)
Institution Deemed to be University
U/s 3 of the UGC Act, 1956
THANJAVUR - 613 403, TAMIL NADU



DEAN
School of Engineering and Tech.
Ponnalyah Ramajayam Institute of
Science and Technology (PRIST)
Deemed to be University
Thanjavur, Thanjavur - 613 403.



PONNAIYAH RAMAJAYAM INSTITUTE OF
SCIENCE & TECHNOLOGY (PRIST)

Declared as DEEMED TO BE UNIVERSITY
U/s 3 of UGC Act, 1956

DEPARTMENT OF ELECTRICAL & ELECTRONICS ENGINEERING

ACADEMIC YEAR 2023-2024

ADD ON COURSE – REWINDING OF INDUCTION MOTOR

LIST OF STUDENTS ENROLLED

S.NO	STUDENT REGISTER	STUDENT NAME
1.	2001EE10101	MURALIDHARAN R
2.	2001EE10102	AKASH A
3.	2101EE13101	SHANMUGARAJ C
4.	2101EE13102	RAJESH KANNAN S
5.	2101EE13103	KARTHICKKEYAN S
6.	2101EE13104	VIJAYARAGAVAN R
7.	2101EE13105	AL AJMAL HAJA K
8.	2101EE13106	ARSATH HUSSAIN AJ
9.	2101EE13107	SANTHOSH P
10.	2101EE13109	SANJAY M
11.	2101EE10101	ABINESHA
12.	2101EE10102	ABINESHK.
13.	2101EE10103	AKILESH T
14.	2101EE10104	AMARESHA
15.	2101EE10105	AROCKIA RAJ S
16.	2101EE10106	CHITRAKUMAR M
17.	2101EE10107	DHARSAN A
18.	2101EE10108	GUNASEELAN S
19.	2101EE10109	IYYAPPAN R
20.	2101EE10110	JOSUVA V
21.	2201EE10101	ASHWANTH R
22.	2201EE10102	ABINESH K
23.	2201EE10103	AKASH T
24.	2201EE10104	ARAVINDHA
25.	2201EE10105	AROCKIA SAMY S
26.	2201EE10106	ARJUNAN A
27.	2201EE10107	CHITRABARATHY P
28.	2201EE10108	CHANDRASEKAR I
29.	2201EE10109	CHANDHRU M
30.	2201EE10110	DINESH S
31.	2301EE10101	ARUNKUMAR R
32.	2301EE10201	AKILA K

Head of the Department
Electrical and Electronics Engineering
Ponnaiyah Ramajayam Institute of
Science & Technology (PRIST)
(Institution Deemed to be University
U/s 3 of the UGC Act, 1956)
THANJAVUR - 613 403, TAMIL NADU

DEAN
School of Engineering and Tech.
Ponnaiyah Ramajayam Institute of
Science and Technology (PRIST)
Deemed to be University
Thanjavur, Thanjavur-613 403

	2301EE10202	ANUSHIKA V
34.	2301EE10203	BARANI S
35.	2301EE10102	BALAKUMARI D
36.	2301EE10103	DHIVYA U
37.	2301EE10204	DHARSHINI L
38.	2301EE10205	DHARUNIKA K
39.	2301EE10206	JANANI G
40.	2301EE10207	JOHITHA M
41.	2301EE10208	KALAISELVI B
42.	2301EE10209	KARTHICKA N
43.	2301EE10210	KAVINAYA T
44.	2301EE10104	LOGAJIT N
45.	2301EE10105	LOKESH R

p. Anney

Head of the Department
Electrical and Electronics Engineering
Ponjeevan Ramajayam Institute of
Science & Technology (PRIST)
 Deemed to be University
 Act 1986,
 THANJAVUR - 613 403, TAMIL NADU

[Signature]

DEAN
College of Engineering and Tech.
Ponjeevan Ramajayam Institute of
Science and Technology (PRIST)
 Deemed to be University
 Vairam, Thanjavur - 613 403



**PONNAIYAH RAMAJAYAM INSTITUTE OF
SCIENCE & TECHNOLOGY (PRIST)**

Declared as DEEMED TO BE UNIVERSITY
U/s 3 of UGC Act, 1956

SCHOOL OF ENGINEERING & TECHNOLOGY

DEPARTMENT OF ELECTRICAL & ELECTRONICS ENGINEERING

PRIST/PO(A)23-24/07

DATE : 02.06.2023

CIRCULAR

SUB: ADD ON COURSE -POWER CONVERTER ANALYSIS AND DESIGN- Reg

It is informed that employability/ entrepreneurship/ skill development training will be started on 12.06.2023 – 14.08.2023 for the academic year 2023-2024. The detailed schedule will be given by the departments.

Heads of the departments are requested to inform their students about the skill development training and motivate them to participate the training classes.

HOD'S are also requested to nominate one faculty member to co-ordinate the training class.

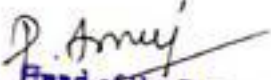
Head of the Department
Electrical and Electronics Engineering
Ponnaiyah Ramajayam Institute of
Science & Technology (PRIST)
Deemed to be University
U/s 3 of the UGC Act, 1956
Vellatt, Thanjavur - 613 403, TAMIL NADU

Copy to:

- The Hon'ble Chairman Sir
- HOD'S for necessary action
- Notice Board
- File

DEAN

DEAN
School of Engineering and Tech.
Ponnaiyah Ramajayam Institute of
Science and Technology (PRIST)
Deemed to be University
Vellatt, Thanjavur - 613 403.



PONNAIYAH RAMAJAYAM INSTITUTE OF SCIENCE & TECHNOLOGY (PRIST)

Declared as DEEMED TO-BE-UNIVERSITY
U/s 3 of UGC Act, 1956

DEPARTMENT OF ELECTRICAL AND ELECTRONICS ENGINEERING



INFORMATION BROCHURE

ADD ON COURSE – POWER CONVERTER AND DESIGNS

(Certificate Course)

P. Arumugam
Head of the Department
Electrical and Electronics Engineering
Ponnaiyah Ramajayam Institute of
Science & Technology (PRIST)
Institution Deemed to be University
U/s 3 of the UGC Act, 1956
THANJAVUR - 613 403, TAMIL NADU

DEAN
Department of Engineering and Tech.
Ponnaiyah Ramajayam Institute of
Science and Technology (PRIST)
Deemed to be University
Vallam, Thanjavur - 613 403.

ABOUT THE INSTITUTION:

Ponnaiyah Ramajayam Institute of Science and Technology (PRIST), a Deemed University (U/s 3 of the UGC Act 1956), is one of the renowned units of Ponnaiyah Ramajayam Institutions, which are serving for more than 25 years in promoting quality education and research for our Indian community, since its Inception. The institution is now brimming with many social responsibilities, particularly in promoting quality education through research.

About the Department:

The department of Electrical and Electronics of PRIST DEEMED UNIVERSITY was established in 2008. Since then its excellence in each and every aspects has played an important role in the institute.

The EEE Department is dedicated to delivering competent electrical engineers to the arena of the real world. They are outfitted with core technical knowledge as well as professional skills necessary to face the challenges of the future. The committed faculty and staff are fully geared up towards this end.

The department has spacious laboratories such as Machines lab, Electric Circuits Lab, Measurement and Instrumentation Lab, Control System Lab, Power Electronics Lab and Power systems Simulation Lab. All the laboratories are fully equipped with latest, modern and sophisticated equipments. The Department has young as well as experienced and dynamic personalities as faculty, is involved in providing quality education at both Undergraduate (UG) and Postgraduate (PG) levels. The staffs are from various disciplines in masters like Power electronics and drives, Power system, advanced communication system. Many of the staff members are encouraged to pursue their higher studies and research works.

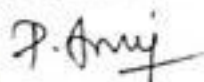

P. Arun
Head of the Department
Electrical and Electronics Engineering
Ponnaiyah Ramajayam Institute of
Science & Technology (PRIST)
Institution Deemed to be University
(U/s 3 of the UGC Act.1956)
V. ANTAIVUR - 613 403, TAMIL NADU



DEAN
School of Engineering and Tech.
Ponnaiyah Ramajayam Institute of
Science and Technology (PRIST)
Deemed to be University
Yakkam, Thanjavur - 613 403.

ABOUT THE INSTITUTION:

PonnaiyahRamajayam Institute of Science and Technology (PRIST), a Deemed University (U/s 3 of the UGC Act 1956), is one of the renowned units of PonnaiyahRamajayam Institutions, which are serving for more than 25 years in promoting quality education and research for our Indian community, since its Inception. The institution is now brimming with many social responsibilities, particularly in promoting quality education through research.

About the Department:

The department of Electrical and Electronics of PRIST DEEMED UNIVERSITY was established in 2008. Since then its excellence in each and every aspects has played an important role in the institute.

The EEE Department is dedicated to delivering competent electrical engineers to the arena of the real world. They are outfitted with core technical knowledge as well as professional skills necessary to face the challenges of the future. The committed faculty and staff are fully geared up towards this end.

The department has spacious laboratories such as Machines lab, Electric Circuits Lab, Measurement and Instrumentation Lab, Control System Lab, Power Electronics Lab and Power systems Simulation Lab. All the laboratories are fully equipped with latest, modern and sophisticated equipments. The Department has young as well as experienced and dynamic personalities as faculty, is involved in providing quality education at both Undergraduate (UG) and Postgraduate (PG) levels. The staffs are from various disciplines in masters like Power electronics and drives, Power system, advanced communication system. Many of the staff members are encouraged to pursue their higher studies and research works.

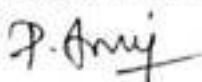

Head of the Department
Electrical and Electronics Engineering
Ponnaiyah Ramajayam Institute of
Science & Technology (PRIST)
Institution Deemed to be University
U/s 3 of the UGC Act, 1956
T. N. TAVUR - 613 403, TAMIL NADU



DEAN
School of Engineering and Tech.
Ponnaiyah Ramajayam Institute of
Science and Technology (PRIST)
Deemed to be University
T. N. TAVUR - 613 403.

POWER CONVERTER AND DESIGNS

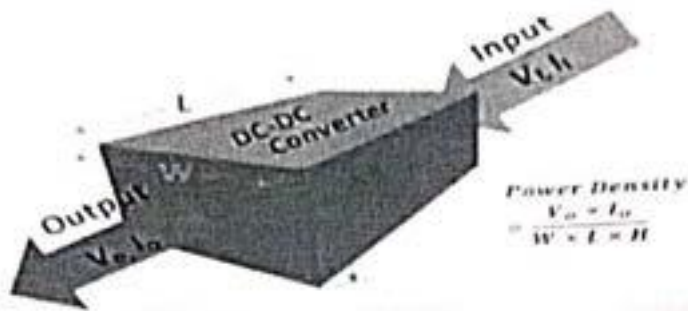

COURSE OBJECTIVE

- Grid-connected PV systems: Power converters are used to connect energy storage systems to the power grid
- Motor control: Power converters are used to control the speed, torque, and current of a motor
- Renewable energy conversion: Power converters are used to convert renewable energy
- Energy storage management: Power converters are used to manage energy storage
- Transportation: Power converters are used in transportation systems
- Wave energy conversion: Power converters are used to convert wave energy

SYLLABUS

UNIT - I

SINGLE PHASE & THREE PHASE CONVERTERS 9 Principle of phase-controlled converter operation – Single phase full converter and semi converter (RL, RLE load), single phase dual converter, Three phase operation full converter and semi-converter (RL, RLE load); Reactive power ; Power factor improvement techniques ; PWM rectifiers.

UNIT - II

DC-DC CONVERTERS 9 Limitations of linear power supplies; switched mode power conversion; Non-isolated DC-DC converters - operation and analysis of Buck, Boost, Buck-Boost, Cuk & SEPIC under continuous and discontinuous operation, Isolated converters- basic operation of Flyback, Forward and Push-pull topologies.

UNIT - III

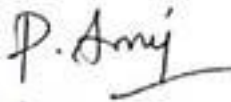
Head of the Department
Electrical and Electronics Engineering
Pondicherry Ramajayam Institute of
Science & Technology (PRIST)
Deemed to be University
Established under UGC Act 1956
TAMILNADU - 605 006, TAMIL NADU

DEAN
School of Engineering and Tech.
Pondicherry Ramajayam Institute of
Science and Technology (PRIST)
Deemed to be University
Valluvar, Thanjavur - 613 403.

DESIGN OF POWER CONVERTER COMPONENTS 9 Introduction to magnetic materials – hard and soft magnetic materials-types of cores, copper windings, Design of transformer; Inductor design equations; Inductor design for buck/ boost/ fly-back converter; Selection of output filter capacitors; Selection of ratings for devices; Input filter design.

UNIT – IV

RESONANT DC-DC CONVERTERS 9 Switching loss, hard switching, and basic principles of soft switching, Classification of resonant converters – Load resonant converters, Series and parallel; Resonant switch converters; Operation and analysis of ZVS, ZCS converters, comparison of ZCS/ZVS, ZVT/ZCT PWM converters.

UNIT – V

AC-AC CONVERTERS 9 Principle of on-off and phase angle control, Single phase ac voltage controller – Analysis with R & RL load, Three phase ac voltage controller, Principle of operation of cyclo converter – Single phase and three phase cyclo converters, Single phase matrix converters and three phase matrix converters.

COURSE OUTCOME

CO1 Ability to understand and analyse the operation, characteristics of controlled rectifiers.

CO2 Ability to apply switching techniques and basic topologies of DC-DC switching regulators.

CO3 Ability to introduce the design of power converter components and to design the converters.

CO4 Ability to provide in-depth knowledge about resonant converters.

CO5 Ability to comprehend the concepts of AC-AC power converters and their applications

Head of the Department
Electrical and Electronics Engineering
Pon. Jayaraj Ramajayam Institute of
Science & Technology (PRIIST)
(Institution Deemed to be University
Affiliated to the UGC Act 1956)
MANJAVUR - 613 403, TANJAVUR

DEAN
Department of Engineering and Tech,
Pon. Jayaraj Ramajayam Institute of
Science and Technology (PRIIST)
Deemed to be University,
Manjavur, Thanjavur - 613 403.



PONNAIYAH RAMAJAYAM INSTITUTE OF
SCIENCE & TECHNOLOGY (PRIST)

Declared as DEEMED TO BE UNIVERSITY
U/a 3 of UGC Act, 1956

DEPARTMENT OF ELECTRICAL & ELECTRONICS ENGINEERING

ACADEMIC YEAR 2023-2024

ADD ON COURSE -
LIST OF STUDENTS ENROLLED

S.NO	STUDENT REGISTER	STUDENT NAME
1.	2101EE13110	R.HARIHARAN
2.	2101EE13111	S MOHAMMED YUSUF
3.	2101EE13112	T.MUGUNDHAN
4.	2101EE13113	PASUPUREDDI PRAVE
5.	2101EE13114	M.SARANYA
6.	2101EE13115	M.CHITRA
7.	2101EE13116	TAMILSELVI
8.	2101EE13117	K.ELAYARAJA
9.	2101EE13118	M.MANIVANNAN
10.	2101EE13119	S.RAJESH
11.	2101EE10111	KANNAN R
12.	2101EE10112	KARTHIKEYAN P
13.	2101EE10113	MOHAMED ALI M
14.	2101EE10114	MURUKESH B
15.	2101EE10115	MUKESH S
16.	2101EE10116	PANDIYAN S
17.	2101EE10117	PRABAKARAN K
18.	2101EE10118	PRAKASH A
19.	2101EE10119	RAJESH R
20.	2101EE10120	RAJIV GANDHI R
21.	2201EE10111	DINESHKUMAR A
22.	2201EE10112	GUNASEKARAN S
23.	2201EE10113	IYYAPPAN K
24.	2201EE10114	JOHITA A
25.	2201EE10115	KANDHAKUMAR H
26.	2201EE10116	KUMAR B L
27.	2201EE10117	KARTHIKEYAN T K
28.	2201EE10118	MANIMARAN R
29.	2301EE13102	RAHUL A
30.	2301EE13105	SHIYAM R
31.	2301EE13106	AJAY E
32.	2201EE10201	NIVEDHA D
33.	2201EE10202	SUGANYA B
34.	2201EE10203	ISHWARYA R
35.	2201EE10204	PRABHA K
36.	2301EE10211	GOPIKA U

P. Jey
Head of the Department
Electrical and Electronics Engineering
Ponnaiyah Ramajayam Institute of
Science & Technology (PRIST)
(Institution Declared to be University
U/a 3 of the UGC Act, 1956)
TRALWAVUR - 612 403, TAMIL NADU

[Signature]
DEAN
School of Engineering and Tech.
Ponnaiyah Ramajayam Institute of
Science and Technology (PRIST)
(Declared to be University
U/a 3 of the UGC Act, 1956)
Tralwaur, Thanjavur - 612 403

	23011110212	KUMARIP
38	23011110105	GOBAL D
39	23011110106	VILASH PUGAN S
40	23011110107	VILAKUMAR R
41	23011110108	MADHAN S
42	23011110109	MATHESH D
43	23011110213	UMARANIM
44	23011110214	THIRUMUKIL J
45	23011110215	JAYAKUMARI J

P. Anuj

Head of the Department
Electrical and Electronics Engineering
Ponnaiyah Ramajayam Institute of
Science & Technology (PRIST)
 Deemed to be University
 Constituted under the UGC Act, 1956
 Thanjavur - 613 403, TAMIL NADU

Anuj

DEAN
 School of Engineering and Tech.
 Ponnaiyah Ramajayam Institute of
 Science and Technology (PRIST)
 Deemed to be University
 Thanjavur - 613 403.



**PONNAIYAH RAMAJAYAM INSTITUTE OF
SCIENCE & TECHNOLOGY (PRIST)**

Declared as DEEMED TO BE UNIVERSITY
U/s 3 of UGC Act, 1956

SCHOOL OF ENGINEERING & TECHNOLOGY

DEPARTMENT OF ELECTRICAL & ELECTRONICS ENGINEERING

PRIST-PO(A)23-24/11

DATE : 27.08.2023

CIRCULAR

SUB: ADD ON COURSE -FAULT ANALYSIS IN HOME APPLIANCES- Reg

It is informed that employability/ entrepreneurship/ skill development training will be started on 02.09.2023 – 07.11.2023 for the academic year 2023-2024. The detailed schedule will be given by the departments.

Heads of the departments are requested to inform their students about the skill development training and motivate them to participate the training classes.

HOD'S are also requested to nominate one faculty member to co-ordinate the training class.

Head of the Department
Electrical & Electronic Engineering
Ponnaiyah Ramajayam Institute of
Science & Technology (PRIST)
Institution Deemed to be University
U/s 3 of the UGC Act, 1956
V. ANJAVUR - 613 403, TAMIL NADU

Copy to:

- The Hon'ble Chairman Sir
- HOD'S for necessary action
- Notice Board
- File

DEAN
School of Engineering and Tech.
Ponnaiyah Ramajayam Institute of
Science and Technology (PRIST)
Deemed to be University
V. Anjavur - 613 403



PONNAIYAH RAMAJAYAM INSTITUTE OF SCIENCE & TECHNOLOGY (PRIST)

Declared as DEEMED TO BE UNIVERSITY
U/s 3 of UGC Act, 1956

DEPARTMENT OF ELECTRICAL AND ELECTRONICS ENGINEERING



INFORMATION BROCHURE

ADD ON COURSE – FAULT ANALYSIS IN HOME APPLIANCES
(Certificate Course)

Head of the Department
Electrical and Electronics Engineering
Ponnaiyah Ramajayam Institute of
Science & Technology (PRIST)
(Institution Deemed to be University
U/s 3 of the UGC Act, 1956)
THANJAVUR - 613 403, TAMIL NADU

DEAN
School of Engineering and Tech.
Ponnaiyah Ramajayam Institute of
Science and Technology (PRIST)
Deemed to be University
Vadali, Thanjavur - 613 403.

ABOUT THE INSTITUTION:

PonnaiyahRamajayam Institute of Science and Technology (PRIST), a Deemed University (U/s 3 of the UGC Act 1956), is one of the renowned units of PonnaiyahRamajayam Institutions, which are serving for more than 25 years in promoting quality education and research for our Indian community, since its Inception. The institution is now brimming with many social responsibilities, particularly in promoting quality education through research.

About the Department:

The department of Electrical and Electronics of PRIST DEEMED UNIVERSITY was established in 2008. Since then its excellence in each and every aspects has played an important role in the institute.

The EEE Department is dedicated to delivering competent electrical engineers to the arena of the real world. They are outfitted with core technical knowledge as well as professional skills necessary to face the challenges of the future. The committed faculty and staff are fully geared up towards this end.

The department has spacious laboratories such as Machines lab, Electric Circuits Lab, Measurement and Instrumentation Lab, Control System Lab, Power Electronics Lab and Power systems Simulation Lab. All the laboratories are fully equipped with latest, modern and sophisticated equipments. The Department has young as well as experienced and dynamic personalities as faculty, is involved in providing quality education at both Undergraduate (UG) and Postgraduate (PG) levels. The staffs are from various disciplines in masters like Power electronics and drives, Power system, advanced communication system. Many of the staff members are encouraged to pursue their higher studies and research works.

FAULT ANALYSIS IN HOME APPLIANCES



Head of the Department
Electrical and Electronics Engineering
Ponnaiyah Ramajayam Institute of
Science & Technology (PRIST)
Deemed to be University
(U/s 3 of UGC Act, 1956)
Ponnaiyah Ramajayam Institutions, Tamil Nadu



DEAN
School of Engineering and Tech.
Ponnaiyah Ramajayam Institute of
Science and Technology (PRIST)
Deemed to be University
Waiiam, Thanjavur - 613 403.



COURSE OBJECTIVE

- Detect faults:** Identify abnormal events that could be a sign of a fault
- Locate faults:** Determine the location of the fault
- Identify faults:** Determine the type, shape, and size of the fault
- Isolate faults:** Quickly isolate faults to minimize disruptions
- Protect people and equipment:** Select appropriate protection gear to ensure safety
- Maintain power quality:** Maintain power quality and reliability

SYLLABUS

Module 1

Introduction to Electricity Electric Charge, Voltage, Electric Current, Ohm's Law, Electric Potential, Cell, Serial and Parallel Circuit, their effect on Voltage and Current Transformer, Use and Operation

Module 2.

Electronic and Electrical Components Active and Passive Components, Resistors, Capacitors and Inductors, their identification, types and application Semiconducting Devices: Diodes, its type, characteristics and applications, Transistors, Integrated Circuits, Study of a transistor, use of a tr 555 timer, IC741, characteristics of 741, Digital ICs, ICs for logic gates, Truth table verification of logic gates, Connectors, Fuse, types, Use of Fuses and its rating, Relays and Switches, Panel Components, Digital electronics – gates and its application, multiplexers, de-multiplexers, counter

Module 3.

Soldering/ De-soldering Techniques Soldering Iron, Soldering wire, Soldering Flux, Soldering method, Zero defect soldering, Desoldering pump, Temperature controlled soldering station, Hands-on-practices of Soldering

Module 4.

Tools and equipment use for Repairing and maintenance of Electrical Equipment Screw Driver Set, Tweezers, Different Types of Tweezers, Nose Pliers, Wire Cutter, Hot air gun, Liquid solder pest,

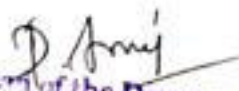

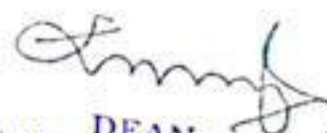
 Head of the Department
 Electrical and Electronic Engineering
 Ponnaiyah Ramajayam Institute of
 Science & Technology (PRIST)
 (Institution Declared to be University
 U/o 3 of the UGC, Act, 1956)
 TRAIJANUR - 613 404, TAMIL NADU

 DEAN
 School of Engineering and Tech.
 Ponnaiyah Ramajayam Institute of
 Science and Technology (PRIST)
 Declared to be University
 Vazhuthi, Thanjavur

Magnifying Lamp and Measuring Tools, Brush, CRO, Nipper, Test and Measurement Equipment, Multimeter Operation etc.

Module 5.

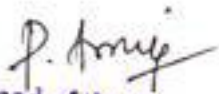
Basic functionality and Installation of washing machine Different type of washing machines & working principle, Basic hand wash process, Different types of technologies being used in Washing machines - Pulsator, Agitator, Agipellar, Tumble wash, 35 Hours Main parts of washing machines and their functionalities etc. Opening the packed Washing machine, Selection of the machine



Head of the Department
Electrical and Electronics Engineering
Ponnaiyah Ramajayam Institute of
Science & Technology (PRIST)
Deemed to be University
of the UGC Act, 1956
Vairam, Thanjavur - 613 402, Tamil Nadu

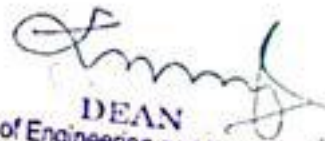

DEAN
School of Engineering and Tech.
Ponnaiyah Ramajayam Institute of
Science and Technology (PRIST)
Deemed to be University
Vairam, Thanjavur - 613 402



PONNAIYAH RAMAJAYAM INSTITUTE OF
SCIENCE & TECHNOLOGY (PRIST)

Declared as DEEMED TO BE UNIVERSITY
U/s 3 of UGC Act, 1956

DEPARTMENT OF ELECTRICAL & ELECTRONICS ENGINEERING

ACADEMIC YEAR 2023-2024

ADD ON COURSE -
LIST OF STUDENTS ENROLLED

S.NO	STUDENT REGISTER	STUDENT NAME
1.	2301EE10216	K ELANNANGAI
2.	2301EE10110	R KATHIRAVAN
3.	2301EE10217	M MANIMOZHI
4.	2101EE10121	RANJITH KUMAR M
5.	2101EE10122	SATHYA A
6.	2101EE10123	SIVA AMUTHAN R
7.	2101EE10124	SUDHARSAN N
8.	2101EE10125	VIGNESH M
9.	2101EE10126	VIKNESHVARAN M
10.	2101EE10127	VINOTHKUMAR R
11.	2101EE10128	ABDUL RAHMAN A
12.	2101EE10129	AHAMMAD IBRAHIM M
13.	2101EE10130	GUNASEKAR A
14.	2101EE10131	HARIHARAN R
15.	2101EE10132	MOHAMED ISMAIL M
16.	2101EE10133	PRASATH B
17.	2101EE10134	S SANGEETH
18.	2101EE10135	R RATHISH
19.	2101EE10136	RAJESHWAR K
20.	2101EE10137	KUMARI S
21.	2101EE10138	MANIMEGALAI R
22.	2101EE10139	SHARMILA K
23.	2101EE10140	VINOTHINI R
24.	2101EE10141	YUVARAJINI I
25.	2101EE10142	ABDUL MOHASITH A
26.	2101EE10143	AHAMMAD IBRAHIM M
27.	2101EE10144	GANESH A
28.	2101EE10145	HARIHARAN R
29.	2101EE10146	MOHAMED ISMAIL M
30.	2101EE10147	PRASATH B
31.	2101EE10148	PREMKUMAR T
32.	2101EE10149	RAJAR
33.	2101EE10150	RAJESH KANNAN K
34.	2101EE10151	NAVJENKUMAR T
35.	2101EE10152	ARSATH ALIM
36.	2101EE10153	KARTHIK P

P. Anuj
Head of the Department
Electrical and Electronics Engineering
Ponnaiyah Ramajayam Institute of
Science & Technology (PRIST)
Deemed to be University
U/s 3 of UGC Act, 1956
Thiruvananthapuram, Kerala - 610 003

Anuj
DEAN
Department of Engineering and Tech.
Ponnaiyah Ramajayam Institute of
Science and Technology (PRIST)
Deemed to be University
Vazhuthi, Thiruvananthapuram - 610 403.

	2101EE10154	KUMAR R
38.	2101EE10155	SANJAY S
39.	2101EE10156	SHANMUGAM K
40.	2101EE13120	S SARAVANAN
41.	2101EE13121	V SUGUMAR
42.	2101EE13122	RAJKUMAR R
43.	2101EE13123	RAMKUMAR I
44.	2101EE13124	RAMADOSS G
45.	2101EE13125	SHARSATH ALLS

P. Anuj

Head of the Department
Electrical and Electronics Engineering
Pennaiyah Ramajayam Institute of
Science & Technology (PRIST)
 Deemed to be University
 Min. HEC Act. 1956,
 Vellore, Tamil Nadu - 619 403, TAMIL NADU

[Signature]

DEAN
Department of Engineering and Tech.
Pennaiyah Ramajayam Institute of
Science and Technology (PRIST)
 Deemed to be University
 Vellore, Thanjavur - 619 403.



**PONNAIYAH RAMAJAYAM INSTITUTE OF
SCIENCE & TECHNOLOGY (PRIST)**

Declared as DEEMED TO BE UNIVERSITY
U.O. 3 of 1984 Act 1956

SCHOOL OF ENGINEERING & TECHNOLOGY

DEPARTMENT OF ELECTRICAL & ELECTRONICS ENGINEERING

PRIST-PO(A)23-24/21

DATE : 12.01.2024

CIRCULAR

SUB: ADD ON COURSE -ADVANCED DIGITAL DESIGN WITH FGPA– Reg

It is informed that employability/ entrepreneurship/ skill development training will be started on 22.01.2024 – 25.03.2024 for the academic year 2023-2024. The detailed schedule will be given by the departments.

Heads of the departments are requested to inform their students about the skill development training and motivate them to participate the training classes.

HOD'S are also requested to nominate one faculty member to co-ordinate the training class.

P. Anuj
Head of the Department
Electrical and Electronics Engineering
Ponnaiyah Ramajayam Institute of
Science & Technology (PRIST)
Deemed to be University
(U.O. 3 of 1984 Act 1956)
Vallam, Thanjavur-610 403.

Copy to:
The Hon'ble Chairman Sir
HOD'S for necessary action
Notice Board
File

[Signature]
DEAN
School of Engineering and Tech.
Ponnaiyah Ramajayam Institute of
Science and Technology (PRIST)
Deemed to be University
Vallam, Thanjavur-610 403.



PONNAIYAH RAMAJAYAM INSTITUTE OF
SCIENCE & TECHNOLOGY (PRIST)

Declared as DEEMED TO BE UNIVERSITY
Via 3 of UGC Act, 1956.

DEPARTMENT OF ELECTRICAL AND ELECTRONICS
ENGINEERING



INFORMATION BROCHURE

ADD ON COURSE - ADVANCED DIGITAL DESIGN WITH FGPA
(Certificate Course)

Head of the Department
of Electrical and Electronics Engineering
Ponnaiyah Ramajayam Institute of
Science & Technology (PRIST)
(Institution Deemed to be University
Via 3 of the UGC Act, 1956)
THANJAVUR - 613 403, TAMIL NADU

Head of the Department
of Electrical and Electronics Engineering
Ponnaiyah Ramajayam Institute of
Science & Technology (PRIST)
(Institution Deemed to be University
Via 3 of the UGC Act, 1956)
THANJAVUR - 613 403, TAMIL NADU

ABOUT THE INSTITUTION:

Ponnaiyah Ramajayam Institute of Science and Technology (PRIST), a Deemed University (U/s 3 of the UGC Act 1956), is one of the renowned units of Ponnaiyah Ramajayam Institutions, which are serving for more than 25 years in promoting quality education and research for our Indian community, since its Inception. The institution is now brimming with many social responsibilities, particularly in promoting quality education through research.

About the Department:

The department of Electrical and Electronics of PRIST DEEMED UNIVERSITY was established in 2008. Since then its excellence in each and every aspects has played an important role in the institute.

The EEE Department is dedicated to delivering competent electrical engineers to the arena of the real world. They are outfitted with core technical knowledge as well as professional skills necessary to face the challenges of the future. The committed faculty and staff are fully geared up towards this end.

The department has spacious laboratories such as Machines lab, Electric Circuits Lab, Measurement and Instrumentation Lab, Control System Lab, Power Electronics Lab and Power systems Simulation Lab. All the laboratories are fully equipped with latest, modern and sophisticated equipments. The Department has young as well as experienced and dynamic personalities as faculty, is involved in providing quality education at both Undergraduate (UG) and Postgraduate (PG) levels. The staffs are from various disciplines in masters like Power electronics and drives, Power system, advanced communication system. Many of the staff members are encouraged to pursue their higher studies and research works.

ADVANCED DIGITAL DESIGN WITH FGPA

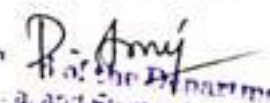
P. Aruj
Head of the Department
Electrical and Electronics Engineering
Ponnaiyah Ramajayam Institute of
Science & Technology (PRIST)
(Institution Deemed to be University
U/s 3 of the UGC Act 1956)
THANJAVUR - 613 403, TAMIL NADU

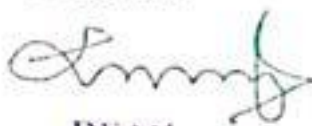
DEAN
School of Engineering and Tech,
Ponnaiyah Ramajayam Institute of
Science and Technology (PRIST)
Deemed to be University
Vairam, Thanjavur - 613 403.

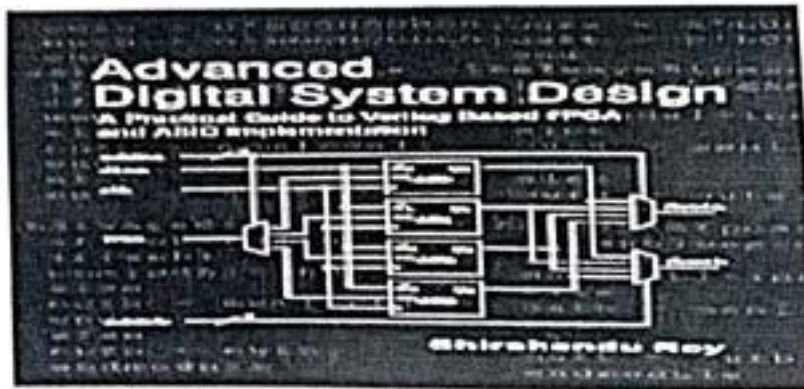

COURSE OBJECTIVE

- Design and implement digital systems:** Students learn how to design and implement digital systems on FPGAs
- Understand design methodologies:** Students learn advanced design methodologies and practical design approaches
- Learn optimization techniques:** Students learn optimization techniques for streaming applications, FIFO and memory architectures, and finite state machines
- Understand FPGA architecture:** Students learn about FPGA architecture, interconnect, and technologies
- Learn how to use HDL:** Students learn how to use HDL to model digital circuits and design systems
- Learn how to use CAD tools:** Students learn how to use CAD tools for design, coding, simulation, and synthesis
- Understand programmable logic devices:** Students learn about programmable logic devices and FPGAs
- Understand timing analysis:** Students learn about timing analysis and how to fit designs within resource, power, and timing constraints

SYLLABUS

UNIT I: Verilog HDL Coding Style: Lexical Conventions - Ports and Modules – Operators - Gate Level Modeling - System Tasks & Compiler Directives - Test Bench - Data Flow Modeling - Behavioral level Modeling -Tasks & Functions.

UNIT II: Overview of FPGA Architectures and Technologies: FPGA Architectural options, coarse vs fine grained, vendor specific issues (emphasis on Xilinx FPGA), Antifuse, SRAM and EPROM based FPGAs, FPGA logic cells, interconnection network and I/O Pad.

UNIT III : Verilog Modelling of Combinational and Sequential Circuits: Behavioral, Data Flow and Structural Realization – Adders – Multipliers- Comparators - Flip Flops - Realization of Shift Register - Realization of a Counter-

P. Arun
 P. Arun, Professor, Department of
 Science & Technology (PRIST)
 Institution Deemed to be University
 U/s 3 of the UGC Act, 1956
 Thanjavur - 613 003, TAMIL NADU

[Signature]
 Department of Engineering and Tech
 P. Arun Ramajayan Institute of
 Science and Technology (PRIST)
 Deemed to be University
 Thanjavur - 613 003

Synchronous and Asynchronous FIFO – Single port and Dual port RAM – Pseudo Random LFSR – Cyclic Redundancy Check.

UNIT IV Synchronous Sequential Circuit: State diagram-state table –state assignment-choice of flipflops – Timing diagram –One hot encoding Mealy and Moore state machines – Design of serial adder using Mealy and Moore state machines - State minimization – Sequence detection- Design examples: Sequence detector, Serial adder, Vending machine using One Hot Controller.

UNIT V System Design Examples using Xilinx FPGAs – Traffic light Controller, Real Time Clock - Interfacing using FPGA: VGA, Keyboard, LCD, Embedded Processor Hardware Desig

Course Outcomes

Understand advanced topics in digital logic design

- Understand proven design methodologies based on standard EDA tools
- Understand the differences and similarities in hardware and software design • Understand modern specification methods (HDL)
- Design combinational devices with a full set of EDAtools (skills)
- Understand modeling and verification with hardware description languages
- Understand synthesis with HDLs
- Understand programmable logic devices and FPGAs

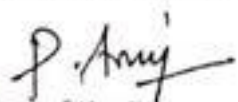
P. Anuj
Head of the Department
Electrical and Electronic Engineering
Ponnuayah Ramajayam Institute of
Science & Technology (PRIST)
(Institution Deemed to be University
Under 3 of the UGC Act, 1956)
TRANJAVUR - 613 403, TAMIL NADU

DEAN
School of Engineering and Tech
Ponnuayah Ramajayam Institute of
Science and Technology (PRIST)
Deemed to be University
Vallam, Thanjavur - 613 403.



PONNAIYAH RAMAJAYAM INSTITUTE OF
SCIENCE & TECHNOLOGY (PRIST)

Deemed to be UNIVERSITY
Act 3 of 1980, Act 1986

DEPARTMENT OF ELECTRICAL & ELECTRONICS ENGINEERING

ACADEMIC YEAR 2023-2024

ADD ON COURSE – REWINDING OF INDUCTION MOTOR

LIST OF STUDENTS ATTENDANCE

SNO	STUDENT NAME	3-hrs (June - Aug).										
		2/6/23	15/6/23	25/6/23	28/6/23	3/7/23	6/7/23	9/7/23	10/7	22/7	4/8	
1	MURALIDHARAN R	/	/	/	/	/	/	/	/	/	/	
2	AKASH A	/	/	/	/	/	/	/	/	/	/	
3	SHANMUGARAJ C	/	/	/	/	/	/	/	/	/	/	
4	RAJESH KANNAN S	/	/	/	/	a	/	/	/	/	/	
5	KARTHICKKEYAN S	/	/	/	/	/	/	/	/	/	/	
6	VIJAYARAGAVAN R	/	/	/	/	/	/	/	/	/	/	
7	AL AJMAL HAJAK	/	a	/	/	/	/	/	/	/	/	
8	ARSATH HUSSAIN AJ	/	/	/	/	/	/	/	a	/	/	
9	SANTHOSH P	/	/	/	/	/	/	/	/	/	/	
10	SANJAY M	/	/	/	/	/	/	/	/	/	/	
11	ABINESH A	/	/	/	/	/	/	/	/	/	/	
12	ABINESH K	/	a	/	/	/	/	/	/	/	/	
13	AKILESH T	/	/	/	/	/	/	a	/	/	/	
14	AMARESH A	/	/	/	/	/	/	/	/	/	/	
15	AROCKIA RAJ S	/	/	/	/	/	/	/	/	a	/	
16	CHITRAKUMAR M	/	/	/	/	/	/	/	/	/	/	
17	DIHARSAN A	/	/	/	/	/	/	/	/	/	/	

P. D. Arany
Dean, School of Engineering and Technology
Ponnaiyah Ramajayam Institute of
Science & Technology (PRIST)
Deemed to be University
Unit 3 of the OGC, Ind. Road
TIRUVARUR - 610 003, TAMIL NADU

[Signature]
DEAN
School of Engineering and Tech.
Ponnaiyah Ramajayam Institute of
Science and Technology (PRIST)
Deemed to be University
Vellam, Thiruvavur - 613 401.

18	GUNASEELAN S	/	/	/	/	/	/	/	/	/	/
19	IYYAPPAN R	/	/	/	/	/	/	/	/	/	/
20	KOSUVA V	/	/	/	/	/	/	/	/	/	/
21	ASIWANTH R	/	/	/	/	/	/	/	/	/	/
22	ABINISH K	/	/	/	/	/	/	/	/	/	/
23	AKASH T	/	/	/	/	/	/	/	/	/	/
24	ARAVINDHA	/	/	/	/	/	/	/	/	/	/
25	AROCKIA SAMY S	/	/	/	/	/	/	/	/	/	/
26	ARUNAN A	/	/	/	/	/	/	/	/	/	/
27	CHITRABARATHY P	a	/	/	/	/	/	/	/	/	/
28	CHANDRASEKAR I	/	/	/	/	/	/	/	/	/	/
29	CHANDHRU M	/	/	/	/	/	/	/	/	/	/
30	DINESH S	/	/	/	/	/	/	/	/	/	/
31	ARUNKUMAR R	/	/	/	/	/	/	/	/	/	/
32	AKILA K	/	/	/	/	/	/	/	/	/	/
33	ANUSHIKA V	/	/	/	/	/	/	/	a	/	/
34	BARANI S	/	/	/	/	/	/	/	/	/	/
35	BALAKUMARI D	/	/	/	/	/	/	/	/	/	/
36	DHIVYA U	/	/	/	/	/	/	/	/	/	/
37	DHARSHINI L	/	/	/	/	/	/	/	/	/	/
38	DHARUNIKA K	/	/	/	/	/	/	/	/	/	/
39	JANANI G	/	/	/	/	/	/	/	/	/	/
40	JOHITHA M	/	/	/	/	/	/	/	/	/	/
41	KALAISELVI B	/	/	/	/	/	/	/	/	/	/
42	KARTHIKA N	/	/	a	/	/	/	/	/	/	/
43	KAVINAYA T	/	/	/	/	/	/	/	/	/	/
44	LOGAJITH N	/	/	/	/	/	/	/	/	/	/
45	LOKESH R	/	/	/	/	/	/	/	/	/	/

P. Arinj

P. of the Department
 Electrical and Electronics Engineering
 Ponnaiyah Ramajayam Institute of
 Science & Technology (PRIST)
 (Institution Deemed to be University
 U/s 3 of the UGC Act 1956)
 THANJAVUR - 612 403, TAMIL NADU

Arinj
 DEAN

School of Engineering and Tech
 Ponnaiyah Ramajayam Institute of
 Science & Technology (PRIST)
 Deemed to be University
 Thanjavur, Tamil Nadu - 612 403



DEPARTMENT OF ELECTRICAL & ELECTRONICS ENGINEERING

ACADEMIC YEAR 2023-2024

ADD ON COURSE - FAULT ANALYSIS IN HOME APPLIANCE
LIST OF STUDENTS ATTENDANCE

S.NO	STUDENT NAME	Jan - Mar									
		22/1	2/2	12/2	22/2	25/2	4/3	10/3	15/3	21/3	25/3
1.	K.ELANNANGAI	/	/	/	/	/	/	/	/	/	/
2.	R.KATHIRAVAN	/	/	/	/	/	/	/	/	/	/
3.	M.MANIMOZHI	/	/	/	/	/	/	/	/	/	/
4.	RANJITH KUMAR M	/	/	/	/	/	/	/	/	/	/
5.	SATHIYA V	/	/	/	/	/	/	/	/	/	/
6.	SIVA AMUTHAN R	/	/	/	/	/	/	/	/	/	/
7.	SUDHARSAN N	/	/	/	/	/	/	/	/	/	/
8.	VIGNESH M	/	/	/	/	/	/	/	/	/	/
9.	VIKNESHIVARAN M	/	/	/	/	/	/	/	/	/	/
10.	VINOTHKUMAR R	/	/	/	/	/	/	/	/	/	/
11.	ABDUL RAHUMAN A	/	/	/	/	/	/	/	/	/	/
12.	AHAMED IBRAHIM M	/	/	/	/	/	/	/	/	/	/
13.	GUNASEKAR A	/	/	/	/	/	/	/	/	/	/
14.	HARIHARAN R	/	/	/	/	/	/	/	/	/	/
15.	MOHAMED ISMAIL M	/	/	/	/	/	/	/	/	/	/
16.	PRASATH B	/	/	/	/	/	/	/	/	/	/
17.	S. SANGEETH	/	/	/	/	/	/	/	/	/	/
18.	R.RATHISH RAJESHWARI K	/	/	/	/	/	/	/	/	/	/

P. Anji

Head of the Department
Electrical and Electronics Engineering
Ponnaiyah Ramajayam Institute of
Science & Technology (PRIST)
Deemed to be University
Via 3 of the UGC Act, 1956
Ponnaiyah Ramajayam Institute of Science & Technology

[Signature]

DEAN
School of Engineering and Tech.
Ponnaiyah Ramajayam Institute of
Science and Technology (PRIST)
Deemed to be University
Vandavasi, Thanjavur - 613 403.

20.	KUMARI S	/	/	/	/	/	/	/	/	/	/
21.	MANIMIGALAI R	/	/	/	/	/	/	/	/	/	/
22.	SHARMILA K	/	/	/	/	/	/	/	/	/	/
23.	VINOTHINER	/	/	/	/	/	/	/	/	/	/
24.	YUVARAHINI I	/	/	/	/	/	/	/	/	/	/
25.	ABDUL MOHASITHA	/	/	/	/	/	/	/	/	/	/
26.	AHAMED IBRAHIM M	/	/	/	/	/	/	/	/	/	/
27.	GANESHA	/	/	/	/	/	/	/	/	/	/
28.	HARIHARAN R	/	/	/	/	/	/	/	/	/	/
29.	MOHAMED ISMAIL M	/	/	/	/	/	/	/	/	/	/
30.	PRASATH B	/	/	/	/	/	/	/	/	/	/
31.	PREMKUMAR T	/	/	/	/	/	/	/	/	/	/
32.	RAJA R	/	/	/	/	/	/	/	/	/	/
33.	RAJESH KANNAN K	/	/	/	/	/	/	/	/	/	/
34.	NAVEENKUMAR T	/	/	/	/	/	/	/	/	/	/
35.	ARSATH ALI M	/	/	/	/	/	/	/	/	/	/
36.	KARTHIK P	/	/	/	/	/	/	/	/	/	/
37.	KUMAR R	/	/	/	/	/	/	/	/	/	/
38.	SANJAY S	/	/	/	/	/	/	/	/	/	/
39.	SHANMUGAM K	/	/	/	/	/	/	/	/	/	/
40.	S SARAVANAN	/	/	/	/	/	/	/	/	/	/
41.	V.SUGUMAR	/	/	/	/	/	/	/	/	/	/
42.	RAJKUMAR R	/	/	/	/	/	/	/	/	/	/
43.	RAMKUMAR L	/	/	/	/	/	/	/	/	/	/
44.	RAMADOSS G	/	/	/	/	/	/	/	/	/	/
45.	SHARSATH ALIS	/	/	/	/	/	/	/	/	/	/

P. Arinj

Head of the Department
 Electrical and Electronics Engineering
 Ponnaiyah Ramajayam Institute of
 Science & Technology (PRIST)
 Institution Deemed to be University
 of the UGC Act.1956
 Vadam, Thanjavur - 612 403, TAMIL NADU

Arinj

DEAN
 School of Engineering and Tech.
 Ponnaiyah Ramajayam Institute of
 Science and Technology (PRIST)
 Deemed to be University
 Vadam, Thanjavur - 612 403.

DEPARTMENT OF ELECTRICAL & ELECTRONICS ENGINEERING

ACADEMIC YEAR 2023-2024

ADD ON COURSE - POWER CONVERTER ANALYSIS AND DESIGN
LIST OF STUDENTS ATTENDANCE

SNO	STUDENT NAME	Sep - Nov									
		2/9/	15/9	25/9	29/9	4/10	8/10	15/10	22/10	29/10	7/11
1.	MURALIDHARAN R	/	/	/	/	/	/	/	/	/	/
2.	AKASH A	/	/	/	/	/	/	/	/	/	/
3.	SHANMUGARAJ C	/	/	/	/	/	/	/	/	/	/
4.	RAJESH KANNAN S	/	/	/	/	/	/	/	/	/	/
5.	KARTHICKKEYAN S	/	/	/	/	/	/	/	/	/	/
6.	VDAYARAGAVAN R	/	/	/	/	/	/	/	/	/	/
7.	AL AJMAL HAJA K	/	/	/	/	/	/	/	/	/	/
8.	ARSATH HUSSAIN AJ	/	/	/	/	/	/	/	/	/	/
9.	SANTHOSH P	/	/	/	/	/	/	/	/	/	/
10.	SANJAY M	/	/	/	/	/	/	/	/	/	/
11.	R HARIHARAN	/	/	/	/	/	/	/	/	/	/
12.	S MOHAMMED YUSUF	/	/	/	/	/	/	/	/	/	/
13.	T MUGUNDHAN	/	/	/	/	/	/	/	/	/	/
14.	PASUPUREDDI PRAVE	/	/	/	/	/	/	/	/	/	/
15.	M.SARANYA	/	/	/	/	/	/	/	/	/	/
16.	M.CHITRA	/	/	/	/	/	/	/	/	/	/
17.	TAMILSELVI	/	/	/	/	/	/	/	/	/	/
18.	K.ELAYARAJA	/	/	/	/	/	/	/	/	/	/
19.	M.MANIVANNAN	/	/	/	/	/	/	/	/	/	/
20.	S RAJESH	/	/	/	/	/	/	/	/	/	/
21.	KANDHAKUMAR H	/	/	/	/	/	/	/	/	/	/
22.	KUMAR B L	/	/	/	/	/	/	/	/	/	/

P. Anuj
Head of the Department
Electrical and Electronics Engineering
Ponnamayyah Ramajayam Institute of
Science & Technology (PRIST)
(Institution Deemed to be University
U/s 3 of the UGC Act, 1956)
KANJAVUR - 613 403, TAMIL NADU

[Signature]
DEAN
School of Engineering and Tech.
Ponnamayyah Ramajayam Institute of
Science and Technology (PRIST)
Deemed to be University
Kanjavur, Thanjavur - 613 403.

23.	KARTHIKEYAN T.K	/	/	/	/	/	/	/	/	/	/
24.	MANIMARAN R	/	/	/	/	/	/	/	/	/	/
25.	RAHUL A	/	/	/	/	/	/	/	/	/	/
26.	SHIYAM R	/	/	/	/	/	/	/	/	/	/
27.	AJAY E	/	/	/	/	/	/	/	/	/	/
28.	NIVEDHA D	/	/	/	/	/	/	/	/	/	/
29.	SUGANYA B	/	/	/	/	/	/	/	/	/	/
30.	ISHWARYA R	/	/	/	/	/	/	/	/	/	/
31.	PRABHA K	/	/	/	/	/	/	/	/	/	/
32.	MUKESH S	/	/	/	/	/	/	/	/	/	/
33.	PANDIYAN S	/	/	/	/	/	/	/	/	/	/
34.	PRABAKARAN K	/	/	/	/	/	/	/	/	/	/
35.	PRAKASH A	/	/	/	/	/	/	/	/	/	/
36.	RAJESH R	/	/	/	/	/	/	/	/	/	/
37.	RAJIV GANDHIR	/	/	/	/	/	/	/	/	/	/
38.	RANJITH KUMAR.M	/	/	/	/	/	/	/	/	/	/
39.	SATHIYA V	/	/	/	/	/	/	/	/	/	/
40.	SIVA AMUTHAN R	/	/	/	/	/	/	/	/	/	/
41.	SUDHARSAN.N	/	/	/	/	/	/	/	/	/	/
42.	VIGNESH.M	/	/	/	/	/	/	/	/	/	/
43.	VIKNEISHVARAN.M	/	/	/	/	/	/	/	/	/	/
44.	LOGAJIT N	/	/	/	/	/	/	/	/	/	/
45.	LOKESH R	/	/	/	/	/	/	/	/	/	/

P. Arny

Head of the Department
Electrical and Electronics Engineering
Ponnavayal Ramajayam Institute of
Science & Technology (PRIST)
Deemed to be University
No. 1 of Old IIT - A, 1984
V. V. MANAVUR - 613 403, TAMIL NADU

Arny

DEAN
School of Engineering and Tech.
Ponnavayal Ramajayam Institute of
Science and Technology (PRIST)
Deemed to be University
Vaviam, Thanjavur - 613 403.



PONNAIYAH RAMAJAYAM INSTITUTE OF
SCIENCE & TECHNOLOGY (PRIST)

DEPARTMENT OF ELECTRICAL & ELECTRONICS ENGINEERING
ACADEMIC YEAR 2023-2024

DEPARTMENT OF ELECTRICAL & ELECTRONICS ENGINEERING

ACADEMIC YEAR 2023-2024

ADD ON COURSE - *ADVANCED DIGITAL DESIGN WITH
PPGA*
LIST OF STUDENTS ATTENDENCE

S.NO	STUDENT NAME	June - Aug.									
		12/6	15/6	25/6	4/7	15/7	22/7	4/8	06/8	12/8	24/8
1.	R.HARIHARAN	/	/	/	/	/	/	/	/	/	/
2.	S.MOHAMMED YUSUF	/	/	/	/	/	/	/	/	/	/
3.	T.MUGUNDHAN	/	/	/	/	/	/	/	/	/	/
4.	PASUPUREDDI PRAVE	/	/	/	/	/	/	/	/	/	/
	M.SARANYA	/	/	/	/	/	/	/	/	/	/

P. Rajaraj
Head of Department
Department of Electrical Engineering
Ponnaiyah Ramajayam Institute of
Science & Technology (PRIST)
Pondicherry, Tamil Nadu University
U-3 of UGC Act 1956
TANJAVUR - 613 403, TAMIL NADU

Amey
DEAN
Department of Engineering and Tech.
Ponnaiyah Ramajayam Institute of
Science and Technology (PRIST)
Tamil Nadu University
Vavuthi, Thanjavur - 613 403.

6	MCHITRA	/	/	/	/	/	/	/	/	/	/
7	TAMILSELVI	/	/	/	/	/	/	/	/	/	/
8	K. ELAYARAJA	/	/	/	/	/	/	/	/	/	/
9	SEEMANIVANNAN	/	/	/	/	/	/	/	/	/	/
10	S. RAJESH	/	/	/	/	/	/	/	/	/	/
11	KANNAN R	/	/	/	/	/	/	/	/	/	/
12	KARTHIKEYAN P	/	/	/	/	/	/	/	/	/	/
13	MOHAMMED ALI M	/	/	/	/	/	/	/	/	/	/
14	MURUKESH B	/	/	/	/	/	/	/	/	/	/
15	MUKESH S	/	/	/	/	/	/	/	/	/	/
16	PANDIYAN S	/	/	/	/	/	/	/	/	/	/
17	PRABAKARAN K	/	/	/	/	/	/	/	/	/	/
18	PRAKASH A	/	/	/	/	/	/	/	/	/	/
19	RAJESH R	/	/	/	/	/	/	/	/	/	/
20	RAJIV GANDHI R	/	/	/	/	/	/	/	/	/	/
21	DINESHKUMAR A	/	/	/	/	/	/	/	/	/	/
22	GUNASEKARAN S	/	/	/	/	/	/	/	/	/	/
23	IYYAPPAN K	/	/	/	/	/	/	/	/	/	/
24	JOHITA	/	/	/	/	/	/	/	/	/	/
25	KANDHAKUMAR H	/	/	/	/	/	/	/	/	/	/
26	KUMAR B L	/	/	/	/	/	/	/	/	/	/
27	KARTHIKEYAN T K	/	/	/	/	/	/	/	/	/	/
28	MANIMARAN R	/	/	/	/	/	/	/	/	/	/
29	RAHUL A	/	/	/	/	/	/	/	/	/	/
30	SHIYAM R	/	/	/	/	/	/	/	/	/	/
31	AJAY E	/	/	/	/	/	/	/	/	/	/
32	NIVEDHA D	/	/	/	/	/	/	/	/	/	/
33	SUGANYA B	/	/	/	/	/	/	/	/	/	/
34	ISHWARYA R	/	/	/	/	/	/	/	/	/	/

P. Arinj

Head of the Department
 School of Electronics Engineering
 Periyar Ramajayam Institute of
 Science & Technology (PRIST)
 (Instituted, 2000 and to the University
 Upto of the UGC, Act. 1986)
 THANJAVUR - 613 403, TAMIL NADU

Arinj
 DEAN

School of Engineering and Tech
 Periyar Ramajayam Institute of
 Science and Technology (PRIST)
 Constituted to the University
 Thanjavur - 613 403.

35.	PRABHA K	/	/	/	/	/	/	/	/	/	/
36.	GOPIKA U	/	/	/	/	/	/	/	/	/	/
37.	KUMARI P	/	/	/	/	/	/	/	/	/	/
38.	GOBAL D	/	/	/	/	/	/	/	/	/	/
39.	VELMURUGAN S	/	/	/	/	/	/	/	/	/	/
40.	VEERAKUMAR R	/	/	/	/	/	/	/	/	/	/
41.	MADHAN S	/	/	/	/	/	/	/	/	/	/
42.	MATHESH D	/	/	/	/	/	/	/	/	/	/
43.	UMARANIM	/	/	/	/	/	/	/	/	/	/
44.	THIRUMUKIL J	/	/	/	/	/	/	/	/	/	/
45.	JAYAKUMARI J	/	/	/	/	/	/	/	/	/	/

P. Anuj

Head of the Department
 Electrical & Electronics Engineering
 Ponnaiyandurai Rajasayam Institute of
 Science & Technology (PRIIST)
 Institution Deemed to be University
 of the UGC Act, 1956,
 Vaitam, Thanjavur - 613 403, TAMIL NADU

Anuj

DEAN
 School of Engineering and Tech.
 Ponnaiyandurai Rajasayam Institute of
 Science and Technology (PRIIST)
 Deemed to be University
 Vaitam, Thanjavur - 613 403.



**PONNAIYAH RAMAJAYAM INSTITUTE OF
SCIENCE & TECHNOLOGY (PRIST)**

Declared as DEEMED-TO-BE UNIVERSITY
U/S 3 of UGC Act, 1956

This is to certify that Mr/Ms. P.KARTHICK OF ELECTRICAL ELECTRONICS
AND ENGINEERING has successfully completed the

ADVANCED DIGITAL DESIGN WITH FGPA Add on Course from

22.01.2024-25.03.2024

[Handwritten signature]

CO-ORDINATOR

P. Karthick



**PONNAIYAH RAMAJAYAM INSTITUTE OF
SCIENCE & TECHNOLOGY (PRIST)**

Declared as DEEMED-TO-BE-UNIVERSITY
U/s 3 of UGC Act, 1956

This is to certify that Mr/Ms. S.SANGEETH - OF ELECTRICAL
ELECTRONICS AND ENGINEERING has successfully completed the

FAULT ANALYSIS IN HOME APPLIANCES Add on Course from

02.09.2023-07.11.2023

CO-ORDINATOR

HOD



**PONNAIYAH RAMAJAYAM INSTITUTE OF
SCIENCE & TECHNOLOGY (PRIST)**

Declared as DEEMED-TO-BE-UNIVERSITY
U/s 3 of UGC Act, 1956

This is to certify that Mr/Ms. M.SANJAY Of ELECTRICAL
ELECTRONICS AND ENGINEERING has successfully completed the

Rewinding of induction motor Add on Course from 12.06.23 to

14.08.2023

CO-ORDINATOR

HEAD



**PONNAIYAH RAMAJAYAM INSTITUTE OF
SCIENCE & TECHNOLOGY (PRIST)**

Declared as DEEMED TO BE UNIVERSITY
U/s 3 of UGC Act, 1956

This is to certify that Mr/Ms. A.AKASH of ELECTRICAL
ELECTRONICS AND ENGINEERING has successfully completed the

Rewinding of induction motor Add on Course from 12.06.23 to
14.08 2023

Arviy

CO-ORDINATOR

P.Arviy

HOD



**PONNAIYAH RAMAJAYAM INSTITUTE OF
SCIENCE & TECHNOLOGY (PRIST)**

Declared as DEEMED-TO-BE-UNIVERSITY
U/s 3 of UGC Act, 1956

This is to certify that Mr/Ms. **R.RAJESH** of ELECTRICAL ELECTRONICS
AND ENGINEERING has successfully completed the

POWER CONVERTER ANALYSIS AND DESIGN Add on Course from

12.06.2023-14.08.2023

CO-ORDINATOR

HOD



**PONNAIYAH RAMAJAYAM INSTITUTE OF
SCIENCE & TECHNOLOGY (PRIST)**

Declared as DEEMED-TO-BE-UNIVERSITY
U/s 3 of UGC Act, 1956

DEPARTMENT OF ELECTRONICS AND COMMUNICATION ENGINEERING

ACADEMIC YEAR 2023-24

Ref:PREC/ECE/2023-24/ODD/03

Date: 01.07.2023

CIRCULAR

It is hereby informed that the Department is offering Add on course for the students. The following courses were offered and their corresponding co-ordinators are also mentioned. The interested students are intimated to register for the same. The classes commences on 4th july, 2024. The detailed schedule is also provided. The registered students are informed to attend the class without fail.

- Certificate course on : Introduction to micro controller
- Certificate course on : Introduction to r programming
- Certificate course on : Network design

HOD

Head Of the Department
Department Of Electronics and
Communication Engineering
Ponnaiyah Ramajayam Institute of
Science & Technology (PRIST)
Deemed to be University
U/s 3 of the UGC Act 1956
THANJAVUR - 613 403, INDIA

DEAN

DEAN

School of Engineering and Tech.
Ponnaiyah Ramajayam Institute of
Science and Technology (PRIST)
Deemed to be University
Valiam, Thanjavur-613 403.



PRIST
DEEMED TO BE
UNIVERSITY
NAAC ACCREDITED
THANJAVUR - 613 483 - TAMIL NADU

**DEPARTMENT OF ELECTRONICS AND COMMUNICATION
ENGINEERING**

**ADD ON COURSE
ON
INTRODUCTION TO MICROCONTROLLER**

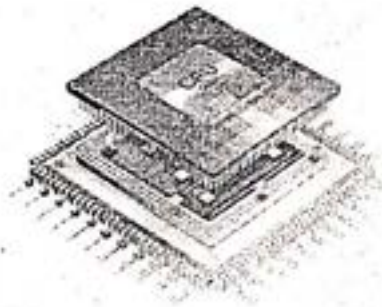

ABOUT THE INSTITUTION

Ponnaiyah Ramajayam Institute of Science and Technology (PRIST), a Deemed University (U/s 3 of the UGC Act 1956), is one of the renowned units of Ponnaiyah Ramajayam Institutions, which are serving for more than 25 years in promoting quality education and research for our Indian community, since its Inception. The institution is now brimming with many social responsibilities, particularly in promoting quality education through research.

ABOUT THE DEPARTMENT

The department of Electronics and Communication Engineering came into existence in 2008 with an objective to impart quality education to meet today's competitive environment.

Department has well experienced and dedicated faculty with strong commitment to provide a vibrant learning environment to the students in order to help them excel. To keep pace with the current technological trends, the department has a well designed, constantly reviewed syllabus to incorporate all advancements in existing and emerging technologies which gives the students a holistic and pragmatic view of the present scenario of industry.

The Department runs an undergraduate course in B. Tech - Electronics and Communication Engineering and postgraduate programme like M. Tech in Communication Systems. Department also offers part time programmes in B. Tech - Electronics and Communication Engineering and M. Tech - Communication Systems.

The Department has state-of-the-art laboratories, such as VLSI lab, Digital Image Processing Lab, Circuit Simulation Lab, Communication Lab, and higher end software like MATLAB, PSPICE, Xilinx, IAR, L-Sim & N-Sim

ABOUT THE COURSE

Introduction to Microcontroller

- A microcontroller is a compact integrated circuit designed to govern a specific operation in an embedded system. A typical microcontroller includes a processor, memory and input/output (I/O) peripherals on a single chip.

- Sometimes referred to as an embedded controller or microcontroller unit (MCU), microcontrollers are found in vehicles, robots, office machines, medical devices, mobile radio transceivers, vending machines and home appliances, among other devices. They are essentially simple miniature personal computers (PCs) designed to control small features of a larger component, without a complex front-end operating system (OS).

- A microcontroller is embedded inside of a system to control a singular function in a device. It does this by interpreting data it receives from its I/O peripherals using its central processor. The temporary information that the microcontroller receives is stored in its data memory, where the processor accesses it and uses instructions stored in its program memory to decipher and apply the incoming data. It then uses its I/O peripherals to communicate and enact the appropriate action.

Prathe
(HOD/EECE)

Devi
DEAN
School of Engineering and Tech,
Ponnaiyah Ramajayam Institute of
Science and Technology (PRIST)
Deemed to be University
Thanjavur - 613 483

Introduction to Microcontroller.

COURSE OBJECTIVE

- To introduce students with the architecture and operation of typical microprocessors and microcontrollers.
- To familiarize the students with the programming and interfacing of microprocessors and microcontrollers.
- To provide strong foundation for designing real world applications using microprocessors and microcontrollers.
- To understand the basic concepts of Embedded Systems and working of a general purpose 8-bit microprocessor operations.
- Analyze how to access Microcontroller ports

Syllabus

Module – 1

The 8051 Instruction Set

- Program Status Word
- Addressing Modes
- Arithmetic Instructions
- Logical Instructions
- Data Transfers
- External RAM
- Lookup Tables

Module – 2

Common Features Description Vectors and assignment

- 8051 Architecture Block Diagram
- Special Function Registers
- Oscillator and Clock Circuit
- CPU Timing
- Port Structures and Operation

Module – 3

Serial Interface

- Baud Rates
- Baud Rate Selection Table for UART
- Internal Baud Rate Generator (BRG)
- Using Timer 1 to Generate Baud Rates
- Using Timer 2 to Generate Baud Rates
- More About Mode 0

Module – 4

Framing Error Detection

- Automatic Address Recognition
- Multiprocessor Communications
- Broadcast Address
- Reset Addresses

Module – 5

UART Registers & Interrupts

- SCON Register
- T2CON Register
- PCON Register
- BDRCON Register
- How Interrupts Are Handled
- External Interrupts
- Response Time

COURSE OUTCOME

- At the end of the course the student will be able to:
- Be familiar with the composition, design, and implementation
- Be familiar with reading and understanding processor and component datasheets
- Be familiar with working on a team to create and apply microcontroller
- Be familiar with the basics of interfacing hardware and software
- Be exposed to history of embedded interfaces

Processor: Atmel 8051 Microcontrollers

Course Duration: 45 Hours

Eligibility: III year Agriculture students

Signature
CHODI (ECE)
PRIST
TANJAVUR - 613 403, TANJAVUR

Signature
DEAN
School of Engineering and Tech.
Sri Jayaraman Ramajayam Institute of
Science and Technology (PRIST)
Tanjavur - 613 403



PRIST
 DEEMED TO BE
UNIVERSITY
 NAAC ACCREDITED
 THANJAVUR - 613 003 - TAMIL NADU

**DEPARTMENT OF ELECTRONICS AND
 COMMUNICATION ENGINEERING**

ஆய்வு-படிப்பு-கூடுதல்
ON
INTRODUCTION TO R PROGRAMMING

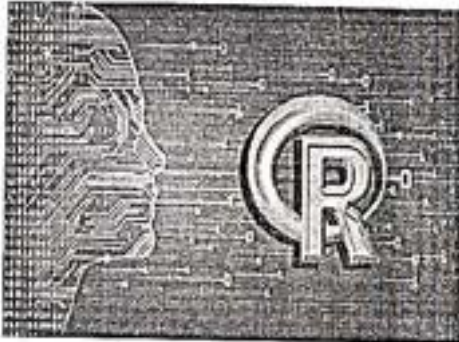

ABOUT THE INSTITUTION

Ponnaiyah Ramajayam Institute of Science and Technology (PRIST), a Deemed University (U/s 3 of the UGC Act 1956), is one of the renowned units of Ponnaiyah Ramajayam Institutions, which are serving for more than 25 years in promoting quality education and research for our Indian community, since its Inception. The institution is now brimming with many social responsibilities, particularly in promoting quality education through research.

ABOUT THE DEPARTMENT

The department of Electronics and Communication Engineering came into existence in 2008 with an objective to impart quality education to meet today's competitive environment.

Department has well experienced and dedicated faculty with strong commitment to provide a vibrant learning environment to the students in order to help them excel. To keep pace with the current technological trends, the department has a well designed, constantly reviewed syllabus to incorporate all advancements in existing and emerging technologies which gives the students a holistic and pragmatic view of the present scenario of industry.

The Department has state-of-the-art laboratories, such as VLSI Lab, Digital Image Processing Lab, Circuit Simulation Lab, Communication Lab, and higher end software like MATLAB, PSPICE, Xilinx, IARL-Sim & N-Sim.

Pruthi
 (MOD/ECE)

The Department runs an undergraduate course in B. Tech - Electronics and Communication Engineering and postgraduate programme like M. Tech in Communication Systems. Department also offers part time programmes in B. Tech - Electronics and Communication Engineering and M. Tech - Communication Systems.

ABOUT THE COURSE

Introduction to R Programming

R is an integrated suite of software facilities for data manipulation, calculation and graphical display. Among other things it has

- an effective data handling and storage facility.
- a suite of operators for calculations on arrays, in particular matrices,
- a large, coherent, integrated collection of intermediate tools for data analysis,
- graphical facilities for data analysis and display either directly at the computer or on hardcopy,
- a well-developed, simple and effective programming language (called 'S') which includes conditionals, loops, user defined recursive functions and input and output facilities.

The term "environment" is intended to characterize it as a fully planned and coherent system, rather than an incremental accretion of very specific and inflexible tools, as is frequently the case with other data analysis software. R is very much a vehicle for newly developing methods of interactive data analysis. It has developed rapidly, and has been extended by a large collection of packages. However, most programs written in R are essentially ephemeral, written for a single piece of data analysis.

COURSE OBJECTIVE

- Understand the different data types in R
- Understand the different data structures in R
- Understand how to create and manipulate dates in R

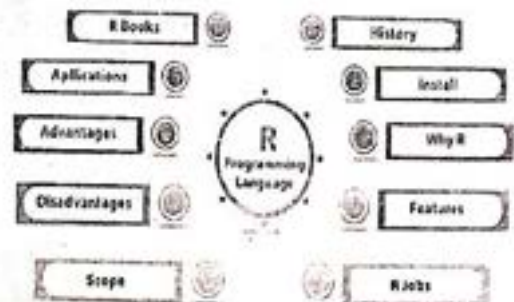

Dean
 DEAN
 School of Engineering and Tech.
 Ponnaiyah Ramajayam Institute of
 Science and Technology (PRIST)
 Deemed to be University
 Vallam, Thanjavur-613 003

R programming Syllabus

Module - 1

Introduction and preliminaries, organize scientific and technical data

- The R environment
- R and the window system
- R commands, case sensitivity, etc
- Executing commands from or diverting output to a file
- Data permanency and removing objects

Module - 2

Simple manipulations; numbers and vectors PID algorithms

- Vectors and assignment
- Vector arithmetic
- Generating regular sequences
- Logical vectors
- Character vectors
- Index vectors; selecting and modifying subsets of a data set

Module - 3

Arrays and matrices intrinsic attributes: mode and length

- Array indexing, Subsections of an array
- The array() function
- Generalized transpose of an array
- Matrix facilities
- Forming partitioned matrices, cbind() and rbind()
- The concatenation function, c(), with arrays
- Frequency tables from factors

Module - 4

Lists and data frames

- Constructing and modifying lists
- Data frames
- The read.table() function
- The scan() function
- Accessing builtin datasets
- Editing data

Module - 5

Grouping, loops and conditional execution

- Grouped expressions
- Named arguments and defaults
- Assignments within functions
- Analysis of variance and model comparison
- Generalized linear models
- The glm() function
- Some non-standard models

COURSE OUTCOME

At the end of the course the student will be able to:

1. Do statistical analysis and data visualization
2. Analyze the results of experiments
3. Crunch the data gathered in pre-clinical trials

Software Used: R 4.3.1

Course Duration: 45 Hours:

Eligibility: II year ECE and EEE students

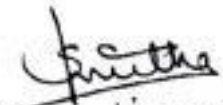
(HOD(ECE))

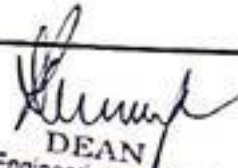
DEAN
School of Engineering and Tech.
Ponnaiyah Ramajayam Institute of
Science and Technology (PRIST)
Deemed to be University
Vallam, Thanjavur-613 403



PRIST
DEEMED TO BE
UNIVERSITY
NAAC ACCREDITED
THANJAVUR - 613 403 - TAMILNADU

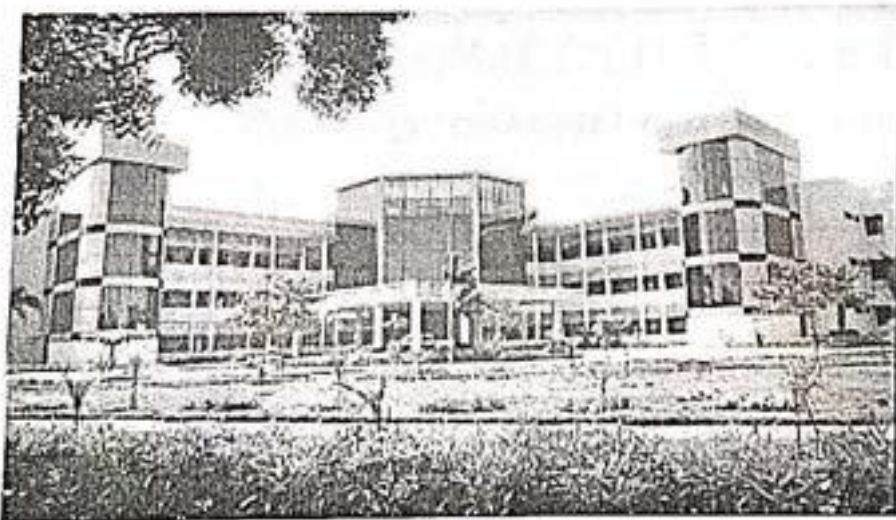

DEPARTMENT OF ELECTRONICS AND COMMUNICATION ENGINEERING
INFORMATION BROCHURE
NETWORK DESIGN

ABOUT THE INSTITUTION

Ponnaiyah Ramajayam Institute of Science and Technology (PRIST), a Deemed University (U/s 3 of the UGC Act 1956), is one of the renowned units of Ponnaiyah Ramajayam Institutions, which are serving for more than 25 years in promoting quality education and research for our Indian community, since its Inception. The institution is now brimming with many social responsibilities, particularly in promoting quality education through research.

ABOUT THE DEPARTMENT

The department of Electronics and Communication Engineering came into existence in 2008 with an objective to impart quality education to meet today's competitive environment.

Department has well experienced and dedicated faculty with strong commitment to provide a vibrant learning environment to the students in order to help them excel.

To keep pace with the current technological trends, the department has a well designed, constantly reviewed syllabus to incorporate all advancements in existing and emerging technologies which gives the students a holistic and pragmatic view of the present scenario of industry.

The Department has the state-of-the-art laboratories, such as VLSI lab, Digital Image Processing Lab, Circuit Simulation Lab, Communication Lab, and higher end software like MATLAB, PSPICE, Xilinx, IAR, L-Sim & N-Sim.

The Department runs ~~an~~ ~~of~~ ~~the~~ ~~best~~ ~~of~~ ~~its~~ ~~kind~~ ~~of~~ ~~courses~~ ~~in~~ ~~B. Tech - Electronics and Communication Engineering~~ and three postgraduate programmes like ~~M. Tech in Communication Systems, Applied Electronics and Embedded systems~~ and ~~M. Tech in Communication Systems, Applied Electronics and Embedded systems~~.

~~The Department currently has research scholars working in the areas of Microelectronics & VLSI Design, Digital Image Processing, Microwave Engineering, Wireless Communication, Analog Signal Processing and Digital Signal Processing.~~

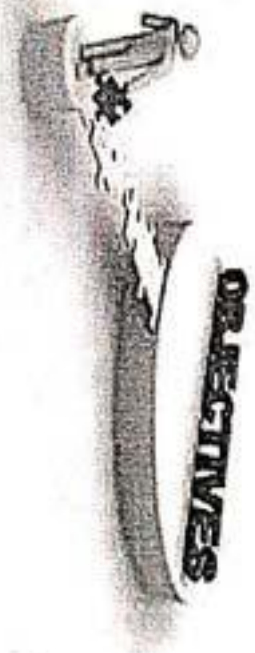

COURSE OBJECTIVES

Real time / embedded systems are designed to provide a timely response to real world events. Events occurring in the real world can have deadlines before which the real time / embedded system must respond and the RTOS scheduling policy must ensure these deadlines are met.

1. Students have knowledge about the basic functions, structure, concepts and applications of embedded systems.
2. Develop familiarity with 8051 Microcontrollers and their applications in an embedded environment.
3. To learn the method of designing and program an Embedded Systems for real time applications.

4. To understand operating system concepts, types and choosing RTOS.

5. Students have knowledge about the development of embedded software using RTOS and implement small programs to solve well defined problems on an embedded platform.

6. Develop familiarity with tools used to develop in an embedded environment.

Pre-requisites

DEAN

School of Engineering and Tech,
Ponnaiyah Ramaiyavar Institute of
Science and Technology (PRIST)
Deemed to be University
Vulliam, Thanjavur - 613,403.

Department of Electronics and
Ponnaiyah Ramaiyavar Institute of
Science and Technology
3 of the UGC Act, 1956
Thanjavur - 613 403, Tamil Nadu.

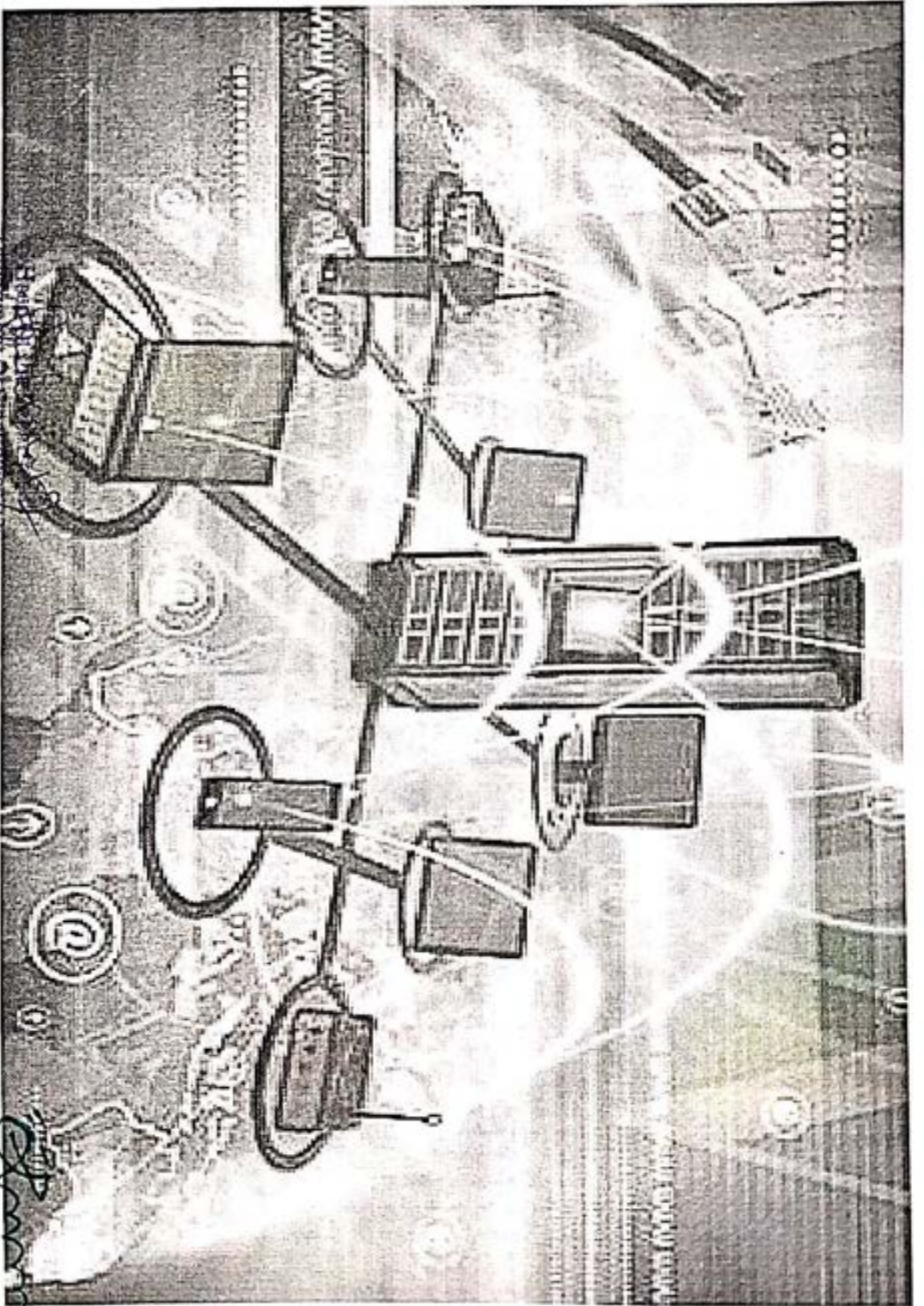

Department Of Electronics
Pondicherry University

Department Of Engineering
Ponnaiyah Ramajayam Institute of
Science & Technology (PRIST)
(Institution Deemed to be University
17E 3 of the UGC Act, 1956)
THANJAVUR - 613 403, TAMIL NADU.

DEAN

School of Engineering and Tech
Ponnaiyah Ramajayam Institute of
Science and Technology (PRIST)
Deemed to be University
Vallam, Thanjavur-613,403.

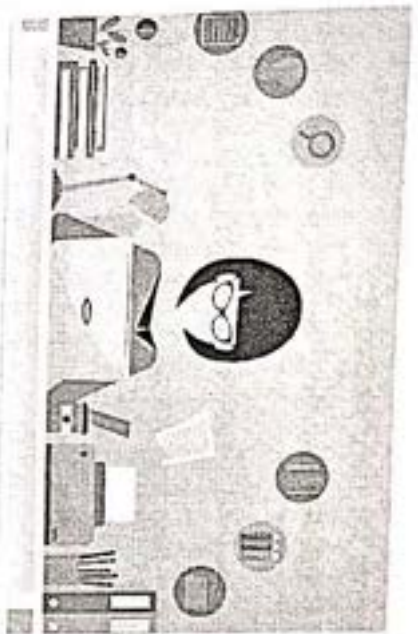

Network Design Overview

Computers and information networks are critical to the success of businesses, both large and small. They connect people, support applications and services, and provide access to the resources that keep the businesses running. To meet the daily requirements of businesses, networks themselves are becoming quite complex.

COURSE CONTENT –NETWORK DESIGN METHODOLOGIES

Large network design projects are normally divided into three distinct steps:

- Step 1. Identify the network requirements.
- Step 2. Characterize the existing network.
- Step 3. Design the network topology and solutions.

Building a Good Network

Good networks do not happen by accident. They are the result of hard work by network designers and technicians, who identify network requirements and select the best solution to meet the needs of a business.

The steps required to design a good network are as follows:

- Step 1. Verify the business goals and technical requirements.
- Step 2. Determine the features and functions required to meet the needs of the business.
- Step 3. Perform a network-readiness assessment.

Head of the Department

Department Of Electronics and
Communication Engineering

Ponnaiyah Ramajayam Institute of
Science and Technology (PRIST)

(Approved by the UGC Act. 1956)

Valluvar - 611 002, Tamil Nadu.

DEAN

School of Engineering and Tech.

Ponnaiyah Ramajayam Institute of
Science and Technology (PRIST)

Deemed to be University,
Valluvar, Tirunelveli - 611 002

Step 5. Create a project plan.

Network Requirements

Most businesses actually have only a few requirements for their network:

- The network should stay up all the time, even in the event of failed links, equipment failure, and overloaded conditions.
- The network should reliably deliver applications and provide reasonable response times from any host to any host.
- The network should be secure. It should protect the data that is transmitted over it and data stored on the devices that connect to it.
- The network should be easy to modify to adapt to network growth and general business changes.
- Because failures occasionally occur, troubleshooting should be easy. Finding and fixing a problem should not be too time-consuming.

Fundamental Design Goals

When examined carefully, these requirements translate into four fundamental network design goals:

- **Scalability:** Scalable network designs can grow to include new user groups and remote sites and can support new applications without impacting the level of service delivered to existing users.
- **Availability:** A network designed for availability is one that delivers consistent, reliable performance, 24 hours a day, 7 days a week. In addition, the failure of a single link or piece of equipment should not significantly impact network performance.
- **Security:** Security is a feature that must be designed into the network, not added on after the network is complete. Planning the location of security devices, filters, and firewall features is critical to safeguarding network resources.
- **Manageability:** No matter how good the initial network design is, the available network staff must be able to manage and support the network. A network that is too complex or difficult to maintain cannot function effectively and efficiently.

ELIGIBILITY

B.Tech -ECE& EEE students only eligible for the admission to the course.

COURSE DURATION: 45 HOURS

- Monday: 4.00-5.30 P.M
- Wednesday: 4.00-5.30 P.M

Head Of the Department
Department Of Electronics and
Communication Engineering
Science & Technology (PRIST)
Institution Deemed to be Univ.
11th 3 of the UGC Act.1956
TANJAVUR - 613 405, TAMIL NADU.

DEAN
School of Engineering and Tech.
Ponnayiah Ramajayam Institute of
Science and Technology (PRIST)
Deemed to be University
Vailam, Thanjavur-613 403.

[Handwritten Signature]

COURSE OUTCOMES

After studying this course the students would gain enough knowledge

1. To present the mathematical model of the system.
2. To develop real-time algorithm for task scheduling.
3. To understand the working of real-time operating systems and real-time database.
4. To work on design and development of protocols related to real-time communication.



DEAN

School of Engineering and Tech.
Ponniyiah Ramajayam Institute of
Science and Technology (PRIST)
Deemed to be University
Vaiyandu, Tirunelveli - 613 403.

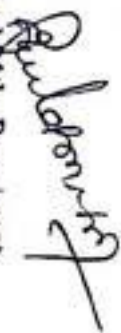

Head of the Department
Department Of Electronics and
Communication Engineering
Ponniyiah Ramajayam Institute of
Science & Technology (PRIST)
Deemed to be University
Vaiyandu - 613 403, Tamil Nadu



**PONNAIYAH RAMAJAYAM INSTITUTE OF
SCIENCE & TECHNOLOGY (PRIST)**

Declared as DEEMED-TO-BE-UNIVERSITY
U/s 3 of UGC Act, 1956

**DEPARTMENT OF ELECTRONICS AND COMMUNICATION ENGINEERING
ACADEMIC YEAR 2023-24**

Ref:PREC/ECE/2023-24/EVEN/03

Date: 01.02.2024

CIRCULAR

It is hereby informed that the Department is offering Add on course for the students. The following courses were offered and their corresponding co-ordinators are also mentioned. The interested students are intimated to register for the same. The classes commences on 6th FEB, 2024. The detailed schedule is also provided. The registered students are informed to attend the class without fail.

Certificate course : Introduction to LABVIEW

Certificate course : Add on course on embedded using raspberry pi

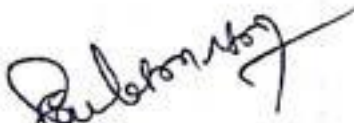
HOD

Head of the Department,
Department Of Electronics and
Communication Engineering
Ponnaiyah Ramajayam Institute of
Science & Technology (PRIST)
(Institution Deemed to be University
U/s 3 of the UGC Act, 1956)
TRANJAVUR - 313 403, TAMIL NADU.

DEAN
DEAN

School of Engineering and Tect,
Ponnaiyah Ramajayam Institute of
Science and Technology (PRIST)
Deemed to be University
Vallam, Thanjavur-613 403.



PONNAIYAH RAMAJAYAM INSTITUTE OF
SCIENCE & TECHNOLOGY (PRIST)
Established as DEEMED TO BE UNIVERSITY
by 2 of UGC Act, 1956

DEPARTMENT OF ELECTRONICS AND COMMUNICATION ENGINEERING

ON INTRODUCTION TO LABVIEW

ABOUT THE INSTITUTION

Ponnaiyah Ramajayam Institute of Science and Technology (PRIST), a Deemed University (U/s 3 of the UGC Act 1956), is one of the renowned units of Ponnaiyah Ramajayam Institutions, which are serving for more than 25 years in promoting quality education and research for our Indian community, since its inception. The institution is now brimming with many social responsibilities, particularly in promoting quality education through research.

ABOUT THE DEPARTMENT

The department of Electronics and Communication Engineering came into existence in 2008 with an objective to impart quality education to meet today's competitive environment.

Department has well experienced and dedicated faculty with strong commitment to provide a vibrant learning environment to the students in order to help them excel. To keep pace with the current technological trends, the department has a well designed, constantly reviewed syllabus to incorporate all advancements in existing and emerging technologies which gives the students a holistic and pragmatic view of the present scenario of industry.

The Department has state-of-the-art laboratories, such as VLSI lab, Digital Image Processing Lab, Circuit Simulation Lab, Communication Lab, and higher end software like MATLAB, PSPICE, Xilinx, IARL-Sim & N-Sim

The Department runs an undergraduate course in B. Tech - Electronics and Communication Engineering and postgraduate programs like M. Tech in Communication Systems. Department also offers part-time programmes in B. Tech - Electronics and Communication Engineering and M. Tech - Communication Systems.

Introduction to LabVIEW

LabVIEW is a graphical programming environment software that is optimized for engineers and scientists. Developed by National Instruments, this software uses a visual approach to programming and is a great program for beginner programmers. You can create visual charts like data flow charts and connect hardware created by NI and other vendors. The programming environment software is available for Apple Mac, Linux, and Microsoft Windows PC 32-bit and 64-bit operating systems. MATLAB is another programming environment that is similar to LabVIEW. MATLAB is geared toward numbers whereas LabVIEW focuses on visualizations. While MATLAB computes and processes data, LabVIEW gathers and tests information. Simulink is another alternative app that is created by MathWorks, the same developers of MATLAB. The Simulink user experience is more comparable to LabVIEW since diagrams are used in both applications.

+

LabVIEW

COURSE OBJECTIVE

1. Use LabVIEW to create data acquisition, analysis and display operations
2. Create user interfaces with charts, graph and buttons
3. Use the programming structures and data types that exist in LabVIEW
4. Use various editing and debugging techniques

Lab View Syllabus

Module - 1

Lab View over MATLAB

- Organize scientific and technical data
- Populate the data into flow charts
- Illustrative charts
- Control instruments and virtual instruments
- Hardware integration

Module - 2

Algorithms and languages used

- PID algorithms
- Add-on algorithms
- Graphical programming language called G
- Custom user interfaces
- Connector and Icon Pane

Module - 3

Navigating Labview

- Menus and tools
- Creating and using labview projects
- Labview front panel and block diagram
- Searching for controls, vis, and functions

Module - 4

Troubleshooting and Debugging

- Build a simple labview application Web Development
- Various debugging and error-checking techniques in labview
- Problems with block diagram organization
- Problems with data passing within a block diagram

[Signature]
CHODICEE

[Signature]
DEAN
School of Engineering & Tech.
Ponnaiyah Ramajayam Institute of
Science and Technology (PRIST)
Deemed to be University
Vailam, Thanjavur - 613 403.

Module - 5

Familiarizing Labview

- Using loops
- Creating and Leveraging Structures
- Modularity (Subvis)
- Acquiring measurements with hardware
- Basic concept of file I/O
- To access and modify file resources
- Using sequential and state machine programming

COURSE OUTCOME

At the end of the course, students will be able to

- > Explore the LabVIEW environment
- > Do interactive analysis, dataflow programming
- > Develop data acquisition, instrument control, data-logging
- > Create applications using the state machine design pattern
- > Acquire, analyze, process, visualize, and store real-world data

Eligibility: ECE & III YEAR B.Sc Physics students are eligible to attend the course.

Software Used: LABVIEW

Course Duration: 45 Hours:

(HOD (ECE))



DEAN
School of Engineering and Tect.
Ponnaiyah Ramajayam Institute of
Science and Technology (PRIST)
Deemed to be University
Vallam, Thanjavur - 613 403.



**PONNAIYAH RAMAJAYAM INSTITUTE OF
SCIENCE & TECHNOLOGY (PRIST)**

Declared as DEEMED-TO-BE-UNIVERSITY
U/s 3 of UGC Act, 1956

SCHOOL OF ENGINEERING AND TECHNOLOGY

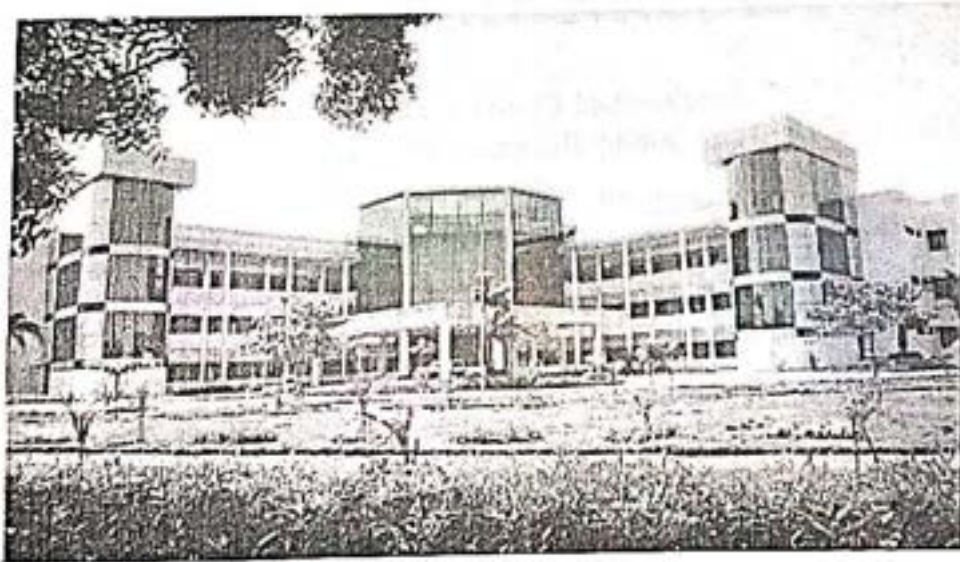

DEPARTMENT OF ELECTRONICS AND COMMUNICATION ENGINEERING

INFORMATION BROCHURE

ADD ON COURSE-DESIGN OF EMBEDDED USING RASPBERRY PI

About the institution

Ponnaiyah Ramajayam Institute Of Science And Technology(Prist),A Deemed University(U/S 3 Of The Ugc Act 1956), Is One Of the Renowned Units Of Ponnaiyah ramajayam institutions, Which Are Serving For More Than 25 Years In Promoting Quality Education And Research For our Indian community, Since Its Inception. The Institution Is Now Brimming with Many social responsibilities, Particularly in Promoting Quality Education through Research.

About the department

The Department Of Electronics And Communication Engineering Came Into Existence In 2008 With an Objective to Impart Quality Education to Meet Today's Competitive Environment.

Department Has well experienced And Dedicated Faculty with strong Commitment To Provide A Vibrant Learning Environment To The Students In Order To Help Them Excel.

To Keep Pace With The Current Technological Trends, The Department Has A Well Designed, Constantly Reviewed Syllabus To Incorporate All Advancements In Existing And Emerging Technologies Which Gives The Students A Holistic And Pragmatic View Of The Present Scenario Of Industry.

The Department has The State-Of-The-Art Laboratories, Such as Vlsi Lab, Digital image Processing Lab, Circuit Simulation Lab, Communication Lab, And higher End Software Like Matlab, Pspice,, Xilinx, Iar,L-Sim & N-Sim .

The Department Runs An Undergraduate Course In B. Tech - Electronics And Communication Engineering And Three Postgraduate Programmes Like M. Tech In Communication Systems, Applied Electronics And Embedded Systems.

The Department Currently Has 25 Research Scholars Working In The Areas Of Microelectronics & Vlsi, Digital Image Processing, Microwave Engineering, Wireless Communication, Analog Signal Processing And Digital signal Processing.

RASPBERRY PI ZERO

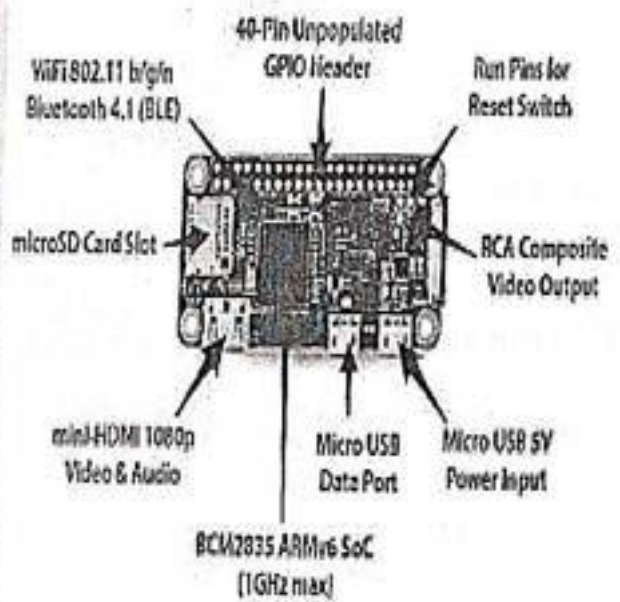
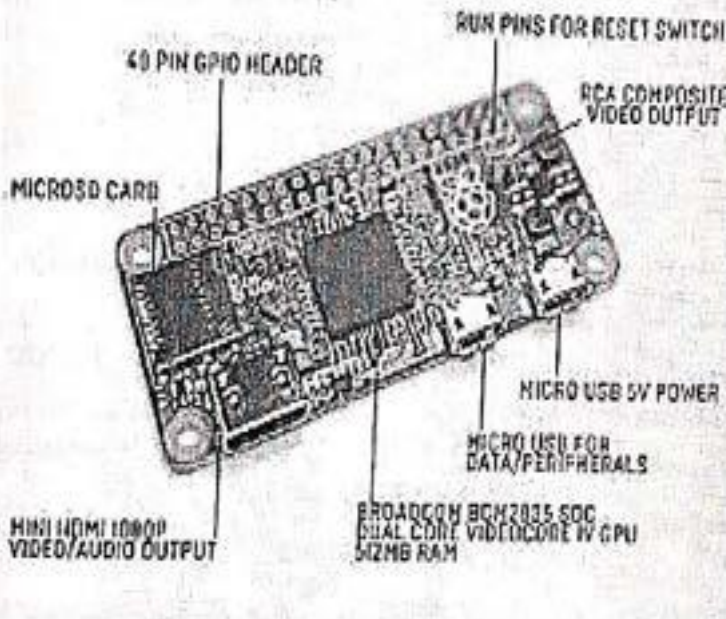

[Signature]
 Head Of the Department
 Department Of Electronics and
 Communication Engineering
 Pennalyah Ramajayam Institute of
 Science & Technology (PRIST)
 (Institution Deemed to be University
 11'a 3 of the UGC Act, 1968)
 THANJAVUR - 613 403, TAMIL NADU.

[Signature]
 DEAN
 School of Engineering and Tech.
 Pennalyah Ramajayam Institute of
 Science and Technology (PRIST)
 Deemed to be University
 Vailam, Thanjavur - 613 403.



Course objectives

Raspberry Pi Zero W is a new product from the Raspberry Pi Zero family. In early 2017, the Raspberry Pi community announced a new board with a wireless extension. It offers wireless functionality and now anyone can develop their own project without cables or other components. Comparing the new board with Raspberry Pi 3 Model B, we can easily see that it is much smaller, with many possibilities for the Internet of Things. However, what is a Raspberry Pi Zero W, and why do you need it? Let's go through the rest of the family and introduce the new board. In this chapter, we will cover the following

topics: An overview of the Raspberry Pi family An introduction to the new Raspberry Pi Zero W Distributions Distributors Common issues

[Signature]
Head of the Department
Department of Electronics and
Communication Engineering
Pennaiyah Ramajayam Institute of
Technology
(Institution deemed to be University
under Sec 3 of the JGC Act, 1956)
THANJAVUR - 613 403, TAMIL NADU.

[Signature]
DEAN
School of Engineering and Tech.
Pennaiyah Ramajayam Institute of
Science and Technology (PRIST)
Deemed to be University
Vallam, Thanjavur - 613 403.

Course content-

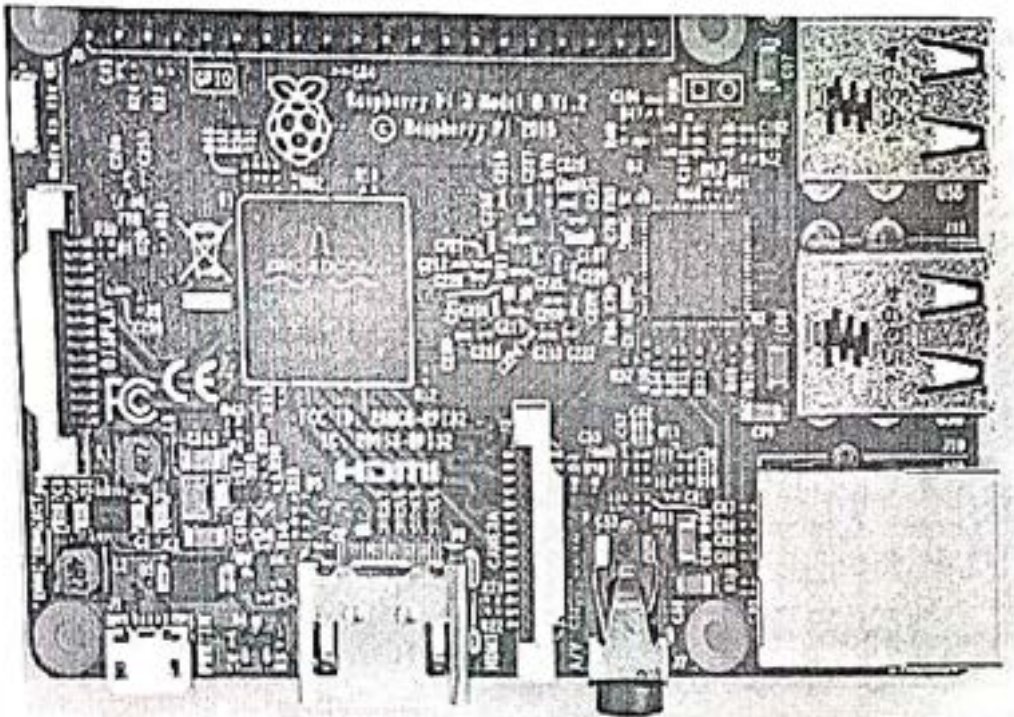

This is the third generation of Raspberry Pi boards after Raspberry Pi 2 and has the following specifications: 1.2 GHz 64-bit quad core ARMv8 CPU 802.11 n wireless LAN Bluetooth 4.1 Bluetooth Low Energy (BLE)

[Signature]
Head of Department
Department of Electronics and
Communication Engineering
Ponnaiyan Ramajayam Institute of
Science & Technology (PRIST)
Institution Deemed to be University
(14 of the UGC Act, 1956)
Vallathur - 613 403, TAMIL NADU.

[Signature]
DEAN
School of Engineering and Tech.
Ponnaiyan Ramajayam Institute of
Science and Technology (PRIST)
Deemed to be University
Vallathur, Tamil Nadu - 613 403.

Specific course information

Description of course content

This course introduces the students to the use of embedded electronic systems for practical application development. Students learn to develop and embed their own Linux-based operating system in a very low-cost embedded system like the Raspberry Pi during the course. The course is organized as laboratory assignments introduced by theory lessons. The laboratory assignments are designed to emphasize application development and integration skills and the presentation of results in an oral and written manner.

List of topics to be covered

1. Introduction to Raspberry Pi: Architecture and hardware resources
2. Raspberry Pi Linux Application development
Raspberry Pi Operating System installation
Linux essential use tutorial
(Optional) Install and configure Ubuntu Virtual Machine
Connecting sensors and actuators to Raspberry Pi
C application development for Raspberry Pi
3. Generation of custom embedded Linux systems
Embedded Linux System Fundamentals
Embedded Linux System generation tools: Buildroot
4. Embedded Linux Application development
Environment configuration for remote connection, development, deployment, testing, and debug
5. IoT Application development using Raspberry Pi and Embedded Linux
IoT fundamentals: Protocols and use cases
Raspberry Pi for IoT applications

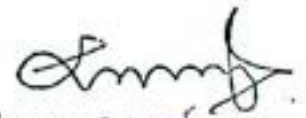

DEAN
School of Engineering and Tech.
Ponnaiyah Ramajayam Institute of
Science and Technology (PRIST)
Deemed to be University
Vallam, Thanjavur - 612 403.

Specific goals for the course

Specific outcomes of instruction

- Know the basic hardware features of an electronic system embedded as RaspBerry IP based on a System On Chip.
- Identify the functionality of each of the digital and analog interfaces included in the RaspBerry-PI.
- Install a Linux operating system and software applications in RaspBerry Pi.
- Learn about the elements of a distribution of Linux for an embedded system.
- Configure and build a distribution of the Linux operating system using the Buildroot for the RaspBerry-IP platform.
- Connect a basic electronic circuit to one of the RaspBerry-IP digital interfaces.
- Develop a basic software application using RaspBerry IP interfaces.
- Document the development of an application with RaspBerry-PI and present it in public.
- Present and defend in public proposed techniques to solve problems.
- Write technical papers presenting the steps followed and the conclusions obtained in the implementation of an application.

Requirements

- A computer + a RaspBerry Pi 4 (also works with RaspBerry 2 and 3)
- A list of hardware components (provided in a free preview lecture at the beginning). You can still start the course without those components.
- NO external monitor or keyboard required.
- NO programming, Unix, or hardware experience required.
- A will to learn and to progress with the RaspBerry Pi

Eligibility

- B.Tech students- Electronics and communication engineering
- M.Tech students -Communication System

Course duration: 45 Hours

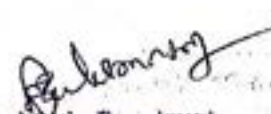
Head of the Department
Department of Electronics and
Communication Engineering
Ponnaiyah Ramajeyam Institute of
Science & Technology (PRIST)
Institution Deemed to be University
3 of the UGC Act, 1956

DEAN
School of Engineering and Tech.
Ponnaiyah Ramajeyam Institute of
Science and Technology (PRIST)
Deemed to be University
Vaiiam, Thanjavur - 613 493.



**PONNAIYAH RAMAJAYAM INSTITUTE OF
SCIENCE & TECHNOLOGY (PRIST)**

Declared as DEEMED-TO-BE-UNIVERSITY
U/s 3 of UGC Act, 1956

SCHOOL OF ENGINEERING AND TECHNOLOGY

DEPARTMENT OF ECE

ACADEMIC YEAR 2023-2024

ADD ON COURSE ON INTRODUCTION TO MICROCONTROLLER

S.NO	NAME LIST	REG NO.	YEAR/BRANCH
1.	SATHEESH M.	2001EC1001	IV/B.TECH - FT
2.	MATHAN B.	2001EC1002	IV/B.TECH - FT
3.	S. EVANGELINE RENILDA	2001EC1003	IV/B.TECH - FT
4.	ROBINSON M.	2001EC1004	IV/B.TECH - FT
5.	K. JAMUNA	2001EC1005	IV/B.TECH - FT
6.	R.SADHEESH	2001EC1006	IV/B.TECH - FT
7.	B. VINAY REDDY	2001EC1007	IV/B.TECH - FT
8.	SRINIVASAN G.	2001EC13101	IV/B.TECH - FT
9.	RAJARAMALINGESHWARAN M.	2001EC13102	IV/B.TECH - FT
10.	SANJIVI BALAJI M.	2001EC13103	IV/B.TECH - FT
11.	YOGASARATHY K.	2001EC13104	IV/B.TECH - FT
12.	PRAVEEN.S	2001EC1008	IV/B.TECH - FT
13.	NISHANTH.S	2001EC1009	IV/B.TECH - FT
14.	REVANTH.S	2001EC1010	IV/B.TECH - FT
15.	MOHAMMED YASHIK.K	2001EC1011	IV/B.TECH - FT
16.	LOKESH	2001EC1012	IV/B.TECH - FT

Head of the Department
Department Of Electronics and
Communication Engineering
Ponnaiyah Ramajayam Institute of
Science & Technology (PRIST)
Institution Deemed to be University
U/s 3 of the UGC Act, 1956
THANJAVUR -613-403, TAMIL NADU.

DEAN
School of Engineering and Tech.
Ponnaiyah Ramajayam Institute of
Science and Technology (PRIST)
Deemed to be University
Valiam, Thanjavur -613,403.

17.	THIRUKUMARAN.C	2001EC1013	IV/B.TECH - FT
18.	RAGUL.R	2001EC1014	IV/B.TECH - FT
19.	VEERAMANI.A	2001EC1015	IV/B.TECH - FT
20.	SALAMAN.P	2001EC1016	IV/B.TECH - FT
21.	MANIKANDAN.E	2001EC1017	IV/B.TECH - FT
22.	SRINIVASAN G.	2001EC1018	IV/B.TECH - FT
23.	RAJA RAMALINGESHWARAN M.	2001EC1019	IV/B.TECH - FT
24.	YOGASARATHY S.	2001EC1020	IV/B.TECH - FT
25.	SANJEEVI BALAJI M.	2001EC1021	IV/B.TECH - FT
26.	K. AKASH	2001EC1022	IV/B.TECH - FT
27.	S.SATYA PRAKASH	2001EC1023	IV/B.TECH - FT
28.	D.AJAYKUMAR	2001EC1024	IV/B.TECH - FT
29.	S. YOGESH	2001EC1025	IV/B.TECH - FT
30.	V. VIJAY ANAND	2001EC1026	IV/B.TECH - FT
31.	GUNA SUNDHAR.S	2001EC1027	IV/B.TECH - FT
32.	B. PARTHASARATHI	2001EC1028	IV/B.TECH - FT
33.	R.VIKRAMAN	2001EC1029	IV/B.TECH - FT
34.	GOVINDASWAMY V.	2001EC1030	IV/B.TECH - FT
35.	KANNAN.S	2001EC1031	IV/B.TECH - FT
36.	KRISHNA.S	2001EC1032	IV/B.TECH - FT
37.	SUNDAR RAJ.R	2001EC1033	IV/B.TECH - FT
38.	SIVARAMAN.S	2001EC1034	IV/B.TECH - FT
39.	SATHISHA	2001EC1035	IV/B.TECH - FT
40.	DIVYA DEVI SHINIL Department	2001EC1036	IV/B.TECH - FT DEAN

Department Of Electronics and
Communication Engineering
Ponnaiyan Ramajayam Institute of
Science & Technology (PRIST)
Institution Deemed to be University
3 of the UGC
TANJAVUR - 613 403, TAMIL NADU.

School of Engineering and Tech.
Ponnaiyan Ramajayam Institute of
Science and Technology (PRIST)
Deemed to be University
Valiam, Thanjavur - 613 403;

41.	BALAMURUGAN.B	2001EC1037	IV/B.TECH - FT
42.	GOVINDASWAMY V.	2001EC1038	IV/B.TECH - FT
43.	KAVI P	2001EC1039	IV/B.TECH - FT
44.	IMRAN K	2001EC1040	IV/B.TECH - FT
45.	SIVA A	2001EC1041	IV/B.TECH - FT
46.	PRIYAROHINI M.	2001EC1042	IV/B.TECH - FT
47.	RETHINA VEL V	2001EC1043	IV/B.TECH - FT
48.	VAIYABURI S	2001EC1044	IV/B.TECH - FT
49.	JENIFER M	2001EC1045	IV/B.TECH - FT
50.	KEERTHIVASAN N	2001EC1046	IV/B.TECH - FT
51.	SHAMSHUDEENAHAMED J	2001EC1047	IV/B.TECH - FT
52.	MUKILAN S	2001EC1048	IV/B.TECH - FT
53.	SATHYANATHAN C	2001EC1049	IV/B.TECH - FT
54.	JASMINE BANU P	2001EC1050	IV/B.TECH - FT
55.	MARIMUTHU S	2001EC1051	IV/B.TECH - FT
56.	VETRIVEL VEERAN	2001EC1801	IV/B.TECH - PT
57.	V. VINOOTH	2001EC1802	IV/B.TECH - PT
58.	K LOGANAYAKI	2001EC1803	IV/B.TECH - PT
59.	KUMAR RAJA R.	2001EC1804	IV/B.TECH - PT
60.	VENKATESH	2001EC1805	IV/B.TECH - PT
61.	T NALLASIVAN	2001EC1806	IV/B.TECH - PT
62.	P RAJENDRAN	2001EC1807	IV/B.TECH - PT
63.	ASHOK S	2001EC1808	IV/B.TECH - PT
64.	BALAKRISHNAN M.	2001EC1809	IV/B.TECH - PT

Head of the Department
 Department of Electronics and
 Communication Engineering
 Ponnaiyah Ramajayam Institute of
 Science & Technology (PRIST)
 (Institution Deemed to be University
 under Sec 3 of the UGC Act, 1956)
 THANJAVUR - 613 403, TAMIL NADU

DEAN
 School of Engineering and Tech.
 Ponnaiyah Ramajayam Institute of
 Science and Technology (PRIST)
 Deemed to be University
 Vallam, Thanjavur - 613 403.

65.	PALANIAPPAN A.	2001EC18010	IV/B.TECH - PT
66.	KARTHIKRAJA S.	2001EC18011	IV/B.TECH - PT
67.	ANBALAGAN D.	2001EC18012	IV/B.TECH - PT
68.	DANIEL BALAJI M.	2001EC18013	IV/B.TECH - PT
69.	KRITHIKA A.	2001EC18014	IV/B.TECH - PT
70.	LAXMAN T.	2001EC18015	IV/B.TECH - PT
71.	NILOFER S.	2001EC18016	IV/B.TECH - PT
72.	SURESH R.	2001EC18017	IV/B.TECH - PT
73.	VIVEKANANDAN P.	2001EC18018	IV/B.TECH - PT
74.	R.KARTHIK	2001EC18019	IV/B.TECH - PT
75.	BANCHANDHAR . S	2001EC18020	IV/B.TECH - PT
76.	MOHAN . M	2001EC18021	IV/B.TECH - PT
77.	ARRTHI . R	2001EC18022	IV/B.TECH - PT
78.	ARUL DEVI B	2201CO2001	II/M.TECH - FT
79.	RAMYA M	2201CO2002	II/M.TECH - FT
80.	SURYANILA S	2201CO2003	II/M.TECH - FT
81.	MAHESH G	2201CO2004	II/M.TECH - FT
82.	SARAVANAKUMAR S	2201CO2005	II/M.TECH - FT
83.	RAKESH J	2201CO2006	II/M.TECH - FT
84.	KUMAR D	2201CO2007	II/M.TECH - FT
85.	VEL MURUGAN T	2201CO2008	II/M.TECH - FT
86.	BABU K	2201CO2009	II/M.TECH - FT
87.	SENTHIL V	2201CO2010	II/M.TECH - FT
88.	BALAJI G	2201CO2011	II/M.TECH - FT

Head of the Department
 Department Of Electronics and
 Communication Engineering
 Ponnaiyah Ramajayam Institute of
 Science & Technology (PRIST)
 (Institution Deemed to be University
 under Sec 3 of the UGC Act,1956)
 THANJAVUR - 613 403, TAMIL NADU.

DEAN
 School of Engineering and Tech.
 Ponnaiyah Ramajayam Institute of
 Science and Technology (PRIST)
 Deemed to be University
 Valiam, Thanjavur - 613, 403.

89.	RAJA GURU V	2201CO2012	II/M.TECH - FT
90.	MURUGESAN C	2201CO2013	II/M.TECH - FT
91.	MOORTHY D	2201CO2014	II/M.TECH - FT
92.	MANIVANNAN G	2201CO2015	II/M.TECH - FT
93.	NANDHAGOPLAKRISHAN G	2201CO2016	II/M.TECH - FT
94.	YUVAN R	2201CO2017	II/M.TECH - FT
95.	DURKESH B	2201CO2018	II/M.TECH - FT
96.	JAGADEESH R	2201CO2019	II/M.TECH - FT
97.	MADHUMITHA B	2201CO2020	II/M.TECH - FT
98.	NAVEENA B	2201CO2021	II/M.TECH - FT
99.	AMUTHA S	2201CO2022	II/M.TECH - FT

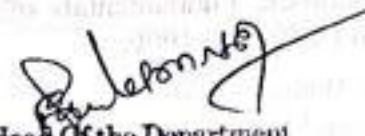
Head Of the Department
 Department Of Electronics and
 Communication Engineering
 Ponnaiyah Ramajayam Institute of
 Science & Technology (PRIST)
 (Institution Deemed to be University
 U/s 3 of the UGC Act.1956)
 THANJAVUR - 613 403, TAMIL NADU

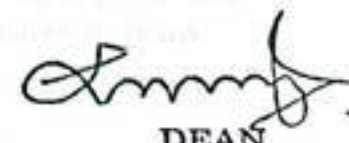
DEAN
 School of Engineering and Tech.
 Ponnaiyah Ramajayam Institute of
 Science and Technology (PRIST)
 Deemed to be University
 Valiam, Thanjavur - 613 403.



**PONNAIYAH RAMAJAYAM INSTITUTE OF
SCIENCE & TECHNOLOGY (PRIST)**

Declared as DEEMED-TO-BE-UNIVERSITY
U/s 3 of UGC Act, 1956

SCHOOL OF ENGINEERING AND TECHNOLOGY

DEPARTMENT OF ECE

ACADEMIC YEAR 2023-2024

ADD ON COURSE ON INTRODUCTION TO R-PROGRAMMING

S.NO	NAME LIST	REG NO.	YEAR/BRANCH
1.	ROHINI C	220IEC13101	III/B.TECH - FT
2.	RAMYA T	220IEC13102	III/B.TECH - FT
3.	KEERTHIVASAN S.	231ECEM31002	III/B.TECH - FT
4.	HARIPRASANTH S	210IEC10103	III/B.TECH - FT
5.	NARESH U	210IEC10104	III/B.TECH - FT
6.	MOHAMED UWAI S A	210IEC10105	III/B.TECH - FT
7.	NAVEEN KUMAR K	210IEC10106	III/B.TECH - FT
8.	N.NANDHINI	210IEC10107	III/B.TECH - FT
9.	DARSHAN.V	210IEC10108	III/B.TECH - FT
10.	BHAGATH SINGH K	210IEC10109	III/B.TECH - FT
11.	KABEER RAHMAN K	210IEC10110	III/B.TECH - FT
12.	MANOJ K	210IEC10111	III/B.TECH - FT
13.	MUKESH S	210IEC10112	III/B.TECH - FT
14.	PRAVEEN B	210IEC10113	III/B.TECH - FT
15.	RAGUL R	210IEC10114	III/B.TECH - FT
16.	RAHUL R	210IEC10115	III/B.TECH - FT

Head of the Department
Department Of Electronics and
Communication Engineering
Ponnaiyah Ramajayam Institute of
Science & Technology (PRIST)
(Institution Deemed to be University
U/s 3 of the UGC Act,1956)
THANJAVUR - 613 403, TAMIL NADU.

DEAN
School of Engineering and Tech.
Ponnaiyah Ramajayam Institute of
Science and Technology (PRIST)
Deemed to be University
Vallam, Thanjavur - 613 403.

17.	RAJ S	2101EC10116	III/B.TECH - FT
18.	RAM LAKSHMANAN S	2101EC10117	III/B.TECH - FT
19.	SANTHOSH R	2101EC10118	III/B.TECH - FT
20.	KARTHIKEYAN V	2101EC10119	III/B.TECH - FT
21.	MOHAMED FAISEL A	2101EC10120	III/B.TECH - FT
22.	MOHAMED IRFAN K M	2101EC10121	III/B.TECH - FT
23.	SANJAI K	2101EC10122	III/B.TECH - FT
24.	THAMILARASAN D	2101EC10123	III/B.TECH - FT
25.	VIGNESH R M	2101EC10124	III/B.TECH - FT
26.	VIMAL M	2101EC10125	III/B.TECH - FT
27.	VISHVADHARSHINI M	2101EC10126	III/B.TECH - FT
28.	AJITHKUMAR P	2101EC10127	III/B.TECH - FT
29.	ARISH A	2101EC10128	III/B.TECH - FT
30.	AAKASHRAM J	2101EC10129	III/B.TECH - FT
31.	ABDUL RAHMAN R	2101EC10130	III/B.TECH - FT
32.	DIVYADHARSHINI K	2101EC10131	III/B.TECH - FT
33.	ESWARAN S	2101EC10132	III/B.TECH - FT
34.	HARISH K	2101EC10133	III/B.TECH - FT
35.	ARUNKUMAR A	2101EC10134	III/B.TECH - FT
36.	JOYAL M	2101EC10135	III/B.TECH - FT
37.	PRADEEP K	2101EC10136	III/B.TECH - FT
38.	SIVANANDHAM K	2101EC10137	III/B.TECH - FT
39.	SURIYA T	2101EC10138	III/B.TECH - FT
40.	VIGNESH R	2101EC10139	III/B.TECH - FT

Head Of the Department
Department of Electronics and
Communication Engineering
Ponnaiyah Ramajayam Institute of
Science & Technology (PRIST)
(Institution Deemed to be University
11/s 3 of the UGC Act, 1956)
THANJAVUR - 613 403

DEAN
School of Engineering and Tech.
Ponnaiyah Ramajayam Institute of
Science and Technology (PRIST)
Deemed to be University
Vallam, Thanjavur - 613,403

41.	ARAVINDH F	2101EC10140	III/B.TECH - FT
42.	BALAKUMAR G	2101EC10141	III/B.TECH - FT
43.	MURUGESH H	2101EC10142	III/B.TECH - FT
44.	HARI BASKER J	2101EC10143	III/B.TECH - FT
45.	KUMAR R	2101EC10144	III/B.TECH - FT
46.	RAMESH G	2101EC10145	III/B.TECH - FT
47.	GANAPATHY PRABHU I	2101EC10146	III/B.TECH - FT
48.	INIYAVEL J	2101EC10147	III/B.TECH - FT
49.	RAGHAVAN K	2101EC10148	III/B.TECH - FT
50.	KISHORE T	2101EC10149	III/B.TECH - FT
51.	GUHANANTHAM V	2101EC18101	III/B.TECH - PT
52.	S.ARIF AHMED	2101EC18102	III/B.TECH - PT
53.	K.LOGAVIKIRAMAN	2101EC18103	III/B.TECH - PT
54.	K.SRIRAM	2101EC18104	III/B.TECH - PT
55.	REEGAN S	2101EC18105	III/B.TECH - PT
56.	R.SARAVANAN	2101EC18106	III/B.TECH - PT
57.	MOHAMED ANAS .A	2101EC18107	III/B.TECH - PT
72.	RAMYA. L.	2101EC18108	III/B.TECH - PT
73.	SNEKA .S	2101EC18109	III/B.TECH - PT
74.	SWETHA .P	2101EC18110	III/B.TECH - PT
75.	N.ARUN KUMAR	2101EC18111	III/B.TECH - PT
76.	M.ABDULLA	2101EC18112	III/B.TECH - PT
77.	ABDUL LATHIFF	2101EC18113	III/B.TECH - PT
78.	SUSEELAN	2101EC18114	III/B.TECH - PT

Head Of the Department
Department of Electronics and
Communication Engineering
Ponnaiyah Ramajayam Institute of
Science & Technology (PRIST)
(Institution Deemed to be University
Under Section 3 of the UGC Act, 1956)
THANJAVUR - 613 403, TAMIL NADU.

DRAN
School of Engineering and Tech.
Ponnaiyah Ramajayam Institute of
Science and Technology (PRIST)
Deemed to be University
Vallam, Thanjavur - 613 403.

79.	T.ABSA BEGUM	2101EC18115	III/B.TECH - PT
80.	R.ARAVINDHAN	2101EC18116	III/B.TECH - PT
81.	S.JAYAM KASTHURI	2101EC18117	III/B.TECH - PT
82.	T.JAYASRI	2101EC18118	III/B.TECH - PT
83.	A.MARIAKARISHMA	2101EC18119	III/B.TECH - PT
84.	E.NOELSOLOMON	2101EC18120	III/B.TECH - PT
85.	G.RUSHMITHA	2101EC18121	III/B.TECH - PT
72.	S.VIGNESHWARAN	2101EC18122	III/B.TECH - PT
73.	R.SWATHI	2101EC18123	III/B.TECH - PT
74.	N.MOHAMMED ARIF	2101EC18124	III/B.TECH - PT
75.	A.ANUSHA	2101EC18125	III/B.TECH - PT
76.	VANI S	2101EC18126	III/B.TECH - PT
77.	SUSHMITHA K	2101EC18127	III/B.TECH - PT
78.	PARTHASARATHY I	2101EC18128	III/B.TECH - PT
79.	ARUL KARTHI M	2101EC18129	III/B.TECH - PT
80.	ZENITH M	2101EC18130	III/B.TECH - PT
81.	VINOTH S	2101EC18131	III/B.TECH - PT
82.	PADMANABAN S	2101EC18132	III/B.TECH - PT
83.	SHYAMALAMBIGAI O	2101EC18133	III/B.TECH - PT
84.	TAMILVAANAN R	2101EC18134	III/B.TECH - PT
85.	BOOBALAN R	2101EC18135	III/B.TECH - PT
86.	NEDUNCHEZHIAN SR	2101EC18136	III/B.TECH - PT
87.	BALAKUMAR P	2101EC18137	III/B.TECH - PT
88.	SHANMUGAM	2101EC18138	III/B.TECH - PT

Head of the Department
Department Of Electronics and
Communication Engineering,
Ponnaiyah Ramajayam Institute of
Science & Technology (PRIST)
(Institution Deemed to be University
U/s 3 of the UGC Act, 1956)
THANJAVUR - 613 403, TAMIL N.A.

School of Engineering and Tech.
Ponnaiyah Ramajayam Institute of
Science and Technology (PRIST)
Deemed to be University
Vattam, Thanjavur - 613 403.

89.	DHANASEKARAN K	210IEC18139	III/B.TECH - PT
90.	ELANTHARAYAN SB	210IEC18140	III/B.TECH - PT
91.	KARTHIKEYAN B	210IEC18141	III/B.TECH - PT
92.	SOUNDARAPANDI K	210IEC18142	III/B.TECH - PT
93.	DEVAN H	210IEC18143	III/B.TECH - PT
94.	VASANTH KD	210IEC18144	III/B.TECH - PT
95.	GUNASEELAN B	210IEC18145	III/B.TECH - PT

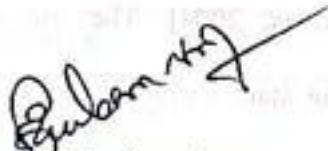
Head of the Department
 Department Of Electronics and
 Communication Engineering
 Ponnaiyah Ramajayam Institute of
 Science & Technology (PRIST)
 (Affiliation Deemed to be University
 11's 3 of the UGC Act.1956)
 THANJAVUR - 613 403, TAMIL NADU.

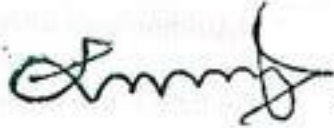
DEAN
 School of Engineering and Tech.
 Ponnaiyah Ramajayam Institute of
 Science and Technology (PRIST)
 Deemed to be University
 Valiam, Thanjavur-613,403.



**PONNAIYAH RAMAJAYAM INSTITUTE OF
SCIENCE & TECHNOLOGY (PRIST)**

Declared as DEEMED-TO-BE-UNIVERSITY
U/s 3 of UGC Act, 1956

SCHOOL OF ENGINEERING AND TECHNOLOGY

DEPARTMENT OF ECE

ACADEMIC YEAR 2023-2024

ADD ON COURSE ON INTRODUCTION TO LAB VIEW

S.NO	NAME LIST	REG NO.	YEAR/BRANCH
1.	PRAGADEESH R	231ECEM31001	II/B.TECH - FT
2.	SANTHOSH V	231ECEM31002	II/B.TECH - FT
3.	AKASH D	2301EC13101	II/B.TECH - FT
4.	ABINESH S	2201EC10102	II/B.TECH - FT
5.	RAVICHANDRAN B	2201EC10103	II/B.TECH - FT
6.	MAHENDRAN B	2201EC10104	II/B.TECH - FT
7.	BHARATHI E	2201EC10105	II/B.TECH - FT
8.	THANGGARASU R	2201EC10106	II/B.TECH - FT
9.	BALASUBRAMANIYAN S	2201EC10107	II/B.TECH - FT
10.	MOHAN G	2201EC10108	II/B.TECH - FT
11.	MATHAN S	2201EC10109	II/B.TECH - FT
12.	SARAN V	2201EC10110	II/B.TECH - FT
13.	LOKESH S	2201EC10111	II/B.TECH - FT
14.	KANAPATHI V	2201EC10112	II/B.TECH - FT
15.	VEERA SELVAM T	2201EC10113	II/B.TECH - FT
16.	VEERA KUMAR	2201EC10114	II/B.TECH - FT

Head of the Department
Department Of Electronics and
Communication Engineering
Ponnaiyah Ramajayam Institute of
Science & Technology (PRIST)
(Institution Deemed to be University
U/s 3 of the UGC Act, 1956)
THANJAVUR - 613 403, TAMIL

DEAN
School of Engineering and Tech.
Ponnaiyah Ramajayam Institute of
Science and Technology (PRIST)
Deemed to be University
Vellam, Thanjavur-613 403.

17.	KARTHIK S	2201EC10115	II/B.TECH - FT
18.	ARUN B	2201EC10116	II/B.TECH - FT
19.	HARISH D	2201EC10117	II/B.TECH - FT
20.	NIRMAL FRANCES	2201EC10118	II/B.TECH - FT
21.	MEENA R	2201EC10119	II/B.TECH - FT
22.	VAIDHEHI R	2201EC10120	II/B.TECH - FT
23.	MANIKANDAN P	2201EC10121	II/B.TECH - FT
24.	SIVARANJANI V	2201EC10122	II/B.TECH - FT
25.	SHARMILA S	2201EC10123	II/B.TECH - FT
26.	BHUVANESHWARI R	2201EC10124	II/B.TECH - FT
27.	SARANYA B	2201EC10125	II/B.TECH - FT
28.	SUGANYA B	2201EC10126	II/B.TECH - FT
29.	ARUNKUMAR M	2201EC1801	II/B.TECH - PT
30.	SANKAR SUBRAMANIYAN M	2201EC1802	II/B.TECH - PT
31.	AMBALATHUARASAN V	2201EC1803	II/B.TECH - PT
32.	SOWMIYA K	2201EC1804	II/B.TECH - PT
33.	VIJAY A	2201EC1805	II/B.TECH - PT
34.	SIVASANGARI E	2201EC1806	II/B.TECH - PT
35.	PRADEEP M	2201EC1807	II/B.TECH - PT
36.	SUDHA S	2201EC1808	II/B.TECH - PT
37.	BASKAR	2201EC1809	II/B.TECH - PT
38.	KARTHIKA B	2201EC1810	II/B.TECH - PT
39.	ABIRAMI U	2201EC1811	II/B.TECH - PT
40.	NILOPARE NISHA	2201EC1812	II/B.TECH - PT

 Head of the Department
 Department Of Electronics and
 Communication Engineering
 Ponnaiyah Ramajayam Institute of
 Science & Technology (PRIST)
 (Institution Deemed to be University
 11/3 of the UGC Act.1956)
 THANJAVUR - 613 403, TAMIL NADU.

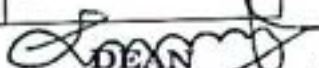
 DEAN
 School of Engineering and Tech.
 Ponnaiyah Ramajayam Institute of
 Science and Technology (PRIST)
 Deemed to be University
 Vallam, Thanjavur - 613 - 7.

41.	AVANTHIKA B	2201EC1813	II/B.TECH - PT
42.	DEVI S	2201EC1814	II/B.TECH - PT
43.	RAVIKAMAL S	2201EC1815	II/B.TECH - PT
44.	KAMALESH V	2201EC1816	II/B.TECH - PT
45.	KRISHNAN V	2201EC1817	II/B.TECH - PT
46.	VIVEK M	2201EC1818	II/B.TECH - PT
47.	MUTHALAKAN D	2201EC1819	II/B.TECH - PT
48.	ARUNASALAM M	2201EC1820	II/B.TECH - PT
49.	DHARANI A	2201EC1821	II/B.TECH - PT
50.	ARUNMOZHI C	2201EC1822	II/B.TECH - PT
51.	BALA G	2201EC1823	II/B.TECH - PT
52.	JAISHANKAR S	2201EC1824	II/B.TECH - PT
53.	NAVIN S	2201EC1825	II/B.TECH - PT
54.	STALIN V	2201EC1826	II/B.TECH - PT
55.	PRABAKARAN P	2201EC1827	II/B.TECH - PT
56.	T.AMUDHA	2201EC1828	II/B.TECH - PT
57.	V.SUDHA	2201EC1829	II/B.TECH - PT
58.	M.VIVEK	2201EC1830	II/B.TECH - PT
59.	V.SAATVIK	2201EC1831	II/B.TECH - PT
60.	R.AVANTHIKA	2201EC1832	II/B.TECH - PT
61.	S.DEEVIKA	2201EC1833	II/B.TECH - PT
62.	YUVARANLP.	2201EC1834	II/B.TECH - PT
63.	MAHESHWARI H	2201EC1835	II/B.TECH - PT
64.	DHINESH K	2201EC1836	II/B.TECH - PT

Head of the Department
 Department Of Electronics and
 Communication Engineering
 Ponnaiyah Ramajayam Institute of
 Science & Technology (PRIST)
 (Institution Deemed to be University
 11's 3 of the UGC Act, 1956)
 THANJAVUR - 613 403, TAMIL NADU.

DEAN
 School of Engineering and Tech.
 Ponnaiyah Ramajayam Institute of
 Science and Technology (PRIST)
 Deemed to be University
 Vallam, Thanjavur - 613,403.

65.	MURALI.D	2201EC1837	II/B.TECH - PT
66.	SAKTHIVEL.D	2201EC1838	II/B.TECH - PT
67.	VINOTH KUMAR	2201EC1839	II/B.TECH - PT
68.	SANGEETHA.V	2201EC1840	II/B.TECH - PT
69.	SARITHA	2201EC1841	II/B.TECH - PT
70.	SARAVANAKUMAR.U	2201EC1842	II/B.TECH - PT
71.	R.RAKESH	2201EC1843	II/B.TECH - PT
72.	S.BABU	2201EC1844	II/B.TECH - PT
73.	MEENAKSHI	2201EC1845	II/B.TECH - PT
74.	SUNDAR R	2201EC1846	II/B.TECH - PT
75.	SANJAY KANNAN G	2201EC1847	II/B.TECH - PT
76.	HARJITH U	2201EC1848	II/B.TECH - PT
77.	MAAMANNAN M	2201EC1849	II/B.TECH - PT
78.	UDHYANITHI S	2201EC1850	II/B.TECH - PT
79.	ASHIKA B	2301CO20201	I/M.TECH - FT
80.	KARAN PANDIYAN	2301CO20202	I/M.TECH - FT
81.	M. RAJ KUMAR	2301CO20203	I/M.TECH - FT
82.	ANBUSELVI.K	2301CO20204	I/M.TECH - FT
83.	KARTHIK.P	2301CO20205	I/M.TECH - FT
84.	LOGESHJ	2301CO20206	I/M.TECH - FT
85.	ASWIN.J	2301CO20207	I/M.TECH - FT
86.	P. GOKULA KRISHNAN	2301CO20208	I/M.TECH - FT
87.	JENITH V	2301CO20209	I/M.TECH - FT
88.	VEH...	2301CO202010	I/M.TECH - FT

Head of the Department
 Department Of Electronics and
 Communication Engineering
 Ponnaiyah Ramajayam Institute of
 Science & Technology (PRIST)
 (Institution Deemed to be University
 's 3 of the UGC Act. 1956)
 THANJAVUR - 613 403, TAMIL NADU.

DEAN
 School of Engineering and Tech.
 Ponnaiyah Ramajayam Institute of
 Science and Technology (PRIST)
 Deemed to be University
 Vallam, Thanjavur-61...3.

89.	JANANIC	2301CO202011	I/M.TECH - FT
90.	RAMYA R	2301CO202012	I/M.TECH - FT
91.	JAGANATHAN H	2301CO202013	I/M.TECH - FT
92.	MUTHUKON A	2301CO202014	I/M.TECH - FT
93.	JAGANATHAN H	2301CO202015	I/M.TECH - FT
94.	MUTHUKON A	2301CO202016	I/M.TECH - FT
95.	SHEELA R	2301CO202017	I/M.TECH - FT
96.	JAFFER SADIQ M	2301CO202018	I/M.TECH - FT
97.	P. GOKULA KRISHNAN	2301CO202019	I/M.TECH - FT
98.	M. F. AHMED RAMEEZ	2301CO202020	I/M.TECH - FT
99.	ARUN M.	2301CO202021	I/M.TECH - FT
100.	V. MURUGAN	2301CO202022	I/M.TECH - FT

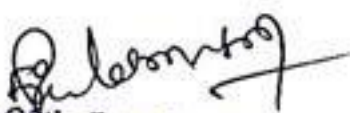
Head Of the Department
 Department Of Electronics and
 Communication Engineering
 Ponnaiyah Ramajayam Institute of
 Science & Technology (PRIST)
 (Institution Deemed to be University
 U/s 3 of the UGC Act, 1956)
 THANJAVUR - 613 403, TAMIL NADU.

DEAN
 School of Engineering and Tech.
 Ponnaiyah Ramajayam Institute of
 Science and Technology (PRIST)
 Deemed to be University
 Vailam, Thanjavur-613,403.



**PONNAIYAH RAMAJAYAM INSTITUTE OF
SCIENCE & TECHNOLOGY (PRIST)**

Declared as DEEMED-TO-BE-UNIVERSITY
U/s 3 of UGC Act, 1956

SCHOOL OF ENGINEERING AND TECHNOLOGY

DEPARTMENT OF ECE

ACADEMIC YEAR 2023-2024

ADD ON COURSE ON NETWORK DESIGN

S.NO	NAME LIST	REG NO.	YEAR/BRANCH
1.	DEIVABATHY S	240IEC13101	I/B.TECH - FT
2.	SWETHA S	2301EC10102	I/B.TECH - FT
3.	UVAN SHANKAR S	2301EC10103	I/B.TECH - FT
4.	AMITH SANKARI E	2301EC10104	I/B.TECH - FT
5.	SELVI G	2301EC10105	I/B.TECH - FT
6.	CHANAKYA SRI R	2301EC10106	I/B.TECH - FT
7.	DURAI ARASAN M	2301EC10107	I/B.TECH - FT
8.	DEENAVATHI H	2301EC10108	I/B.TECH - FT
9.	FINOLIYA G	2301EC10109	I/B.TECH - FT
10.	FAIZAL BANU A	2301EC10110	I/B.TECH - FT
11.	GNANAMBIGAI M	2301EC10111	I/B.TECH - FT
12.	GNANAGANAPATHY K	2301EC10112	I/B.TECH - FT
13.	GUNAVATHI J	2301EC10113	I/B.TECH - FT
14.	GEETHA L	2301EC10114	I/B.TECH - FT
15.	HARINI M	2301EC10115	I/B.TECH - FT
16.	Head of the Department Lecturer in Electronics and Communication Engineering	2301EC10116	I/B.TECH - FT

Ponnaiyah Ramajayam Institute of
Science & Technology (PRIST)
(Institution Deemed to be University
U/s 3 of the UGC Act, 1956)
THANJAVUR - 613 403

School of Engineering and Tech.
Ponnaiyah Ramajayam Institute of
Science and Technology (PRIST)
Deemed to be University
Vallam, Thanjavur - 613,403

17.	LOKAYANAKI K	2301EC10117	I/B.TECH - FT
18.	MARIAM PARVEEN S	2301EC10118	I/B.TECH - FT
19.	MOHAMED RIYAZ M	2301EC10119	I/B.TECH - FT
20.	MURUGAN S	2301EC10120	I/B.TECH - FT
21.	NAVANEETHAM K	2301EC10121	I/B.TECH - FT
22.	NIRMALA D	2301EC10122	I/B.TECH - FT
23.	PERIYANAYAKI H	2301EC10123	I/B.TECH - FT
24.	RAMALINGAM U	2301EC10124	I/B.TECH - FT
25.	RITHIKA P	2301EC10125	I/B.TECH - FT
26.	ROSHINI R	2301EC10126	I/B.TECH - FT
27.	SABARI NIVAS S	2301EC18101	I/B.TECH - PT
28.	KIRANKUMAR A	2301EC18102	I/B.TECH - PT
29.	SANKAR M	2301EC18103	I/B.TECH - PT
30.	BALAJI	2301EC18104	I/B.TECH - PT
31.	VENGATESH S R	2301EC18105	I/B.TECH - PT
32.	BALAJI N A	2301EC18106	I/B.TECH - PT
33.	AANANDHI R	2301EC18107	I/B.TECH - PT
34.	ANANTHA MOORTHY S	2301EC18108	I/B.TECH - PT
35.	ARUMUGAM S	2301EC18109	I/B.TECH - PT
36.	BIBILIA E	2301EC18110	I/B.TECH - PT
37.	ELANGESHWARI R	2301EC18111	I/B.TECH - PT
38.	GUHANEETHAM P	2301EC18112	I/B.TECH - PT
39.	GUNASEELAN E	2301EC18113	I/B.TECH - PT
40.	INDIRA G	2301EC18114	I/B.TECH - PT

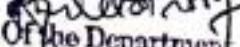
 Head Of the Department
 Department of Electronics and
 Communication Engineering
 Ponnaiyah Ramajayam Institute of
 Science & Technology, Prist
 (Institution Deemed to be University
 U/s 3 of the UGC Act, 1976)
 THANJAVUR - 613 403, TAN

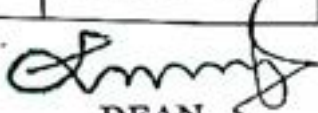
 DEAN
 School of Engineering and Tech.
 Ponnaiyah Ramajayam Institute of
 Science and Technology (PRIST)
 Deemed to be University
 Vallam, Thanjavur - 613 403

41.	KALYANASUNDARI P	2301EC18115	I/B.TECH - PT
42.	KAVIYARASI T	2301EC18116	I/B.TECH - PT
43.	KAVIYARASU K	2301EC18117	I/B.TECH - PT
44.	KRISHNAN G	2301EC18118	I/B.TECH - PT
45.	LALITHA K	2301EC18119	I/B.TECH - PT
46.	MANOHARI R	2301EC18120	I/B.TECH - PT
47.	MANONMANI S	2301EC18121	I/B.TECH - PT
48.	MOHANAMBAL M	2301EC18122	I/B.TECH - PT
49.	MOHEMED RAFI S	2301EC18123	I/B.TECH - PT
50.	MUTHUMEENA H	2301EC18124	I/B.TECH - PT
51.	MUNIAPPAN K	2301EC18125	I/B.TECH - PT
52.	MURUGAVEL J	2301EC18126	I/B.TECH - PT
53.	MURUGESAN K	2301EC18127	I/B.TECH - PT
54.	OORVASI I	2301EC18128	I/B.TECH - PT
55.	PADMA I	2301EC18129	I/B.TECH - PT
56.	PALANISAMY J	2301EC18130	I/B.TECH - PT
57.	PALANISWAMY J	2301EC18131	I/B.TECH - PT
58.	PALANIVEL J	2301EC18132	I/B.TECH - PT
59.	PALANIYAPPAN M	2301EC18133	I/B.TECH - PT
60.	PARKAVI T	2301EC18134	I/B.TECH - PT
61.	PAVITHRA J	2301EC18135	I/B.TECH - PT
62.	PRAGADAMBAL A	2301EC18136	I/B.TECH - PT
63.	PRIYA FRANCIS	2301EC18137	I/B.TECH - PT
64.	PUGALENDHI E	2301EC18138	I/B.TECH - PT

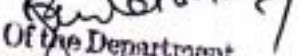
 Head Of the Department
 Department Of Electronics and
 Communication Engineering
 Ponnaiyah Ramajayam Institute of
 Science & Technology (PRIST)
 (Institution Deemed to be University
 11/s 3 of the UGC Act.1956)
 THANJAVUR - 613 403, TAMIL NADU

 DEAN
 School of Engineering and Tech.
 Ponnaiyah Ramajayam Institute of
 Science and Technology (PRIST)
 Deemed to be University
 Vallam, Thanjavur - 613 403.



**PONNAIYAH RAMAJAYAM INSTITUTE OF
SCIENCE & TECHNOLOGY (PRIST)**

Declared as DEEMED-TO-BE-UNIVERSITY
U/s 3 of UGC Act, 1956

SCHOOL OF ENGINEERING AND TECHNOLOGY

DEPARTMENT OF ECE

ACADEMIC YEAR 2023-2024

ADD ON COURSE ON EMBEDDED USING RASPBERRY PI

S.NO	NAME LIST	REG NO.	YEAR/BRANCH
1.	DEEPIKA C	2301CO28101	I/M.TECH - PT
2.	DISAN R	2301CO28102	I/M.TECH - PT
3.	ANURATHA N	2301CO28103	I/M.TECH - PT
4.	ANURADHA D	2301CO28104	I/M.TECH - PT
5.	DHIVYA PRABA A	2301CO28105	I/M.TECH - PT
6.	ARUN SUBBAIYAN E	2301CO28106	I/M.TECH - PT
7.	ANBUSELVAN M	2301CO28107	I/M.TECH - PT
8.	AROKIA RAJ S	2301CO28108	I/M.TECH - PT
9.	J. MANIGANDAN	2301CO28109	I/M.TECH - PT
10.	ARUNA L	2301CO28110	I/M.TECH - PT
11.	ABINESH A	2301CO28111	I/M.TECH - PT
12.	CHANDRU S	2301CO28112	I/M.TECH - PT
13.	DINESH K	2301CO28113	I/M.TECH - PT
14.	ELANKUMARAN R	2301CO28114	I/M.TECH - PT
15.	JACKSON U	2301CO28115	I/M.TECH - PT
16.	THANGDURAI	2301CO28116	I/M.TECH - PT

Head of the Department
Department of Electronics and
Communication Engineering
Ponnaiyah Ramajayam Institute of
Science & Technology (PRIST)
Institution Deemed to be University
U/s 3 of the UGC Act, 1956
THANJAVUR - 613 403, Tamil Nadu

DEAN
School of Engineering and Tech.
Ponnaiyah Ramajayam Institute of
Science and Technology (PRIST)
Deemed to be University
Vandalur, Thanjavur - 613 403

17.	SELVI I		I/M.TECH - PT
18.	SENBAGAM P	2301CO28117	I/M.TECH - PT
19.	R. PRIMIYA	2301CO28118	I/M.TECH - PT
20.	R. RAJAPRIYA	2301CO28119	I/M.TECH - PT
21.	PALANIVEL K.	2301CO28120	I/M.TECH - PT
22.	AMRUTHAN B	2201CO2801	II/M.TECH - PT
23.	BALU J	2201CO2802	II/M.TECH - PT
24.	HARIKISHORE T	2201CO2803	II/M.TECH - PT
25.	CHINNAYAN K	2201CO2804	II/M.TECH - PT
26.	BHEEM SINGH I	2201CO2805	II/M.TECH - PT
27.	VIDHYA LAKSHMI H	2201CO2806	II/M.TECH - PT
28.	HARSHATH S	2201CO2807	II/M.TECH - PT
29.	ASIF SULTAN J	2201CO2808	II/M.TECH - PT
30.	CHRISTOPHER A	2201CO2809	II/M.TECH - PT
31.	JENITH V	2201CO2810	II/M.TECH - PT
32.	VINOTH KANNAN K	2201CO2811	II/M.TECH - PT
33.	LAVANYA B	2201CO2812	II/M.TECH - PT
34.	WILSON FAZIL G	2201CO2813	II/M.TECH - PT
35.	GNANAPRAKASAM J	2201CO2814	II/M.TECH - PT
36.	SUYAMBU K	2201CO2815	II/M.TECH - PT
37.	SUNDAR VATHAN H	2201CO2816	II/M.TECH - PT
38.	JACQUINE MARY A	2201CO2817	II/M.TECH - PT
39.	SOUNDHARAJAN R	2201CO2818	II/M.TECH - PT
40.	VISINIVARDHAN H	2201CO2819	II/M.TECH - PT
		2201CO2820	II/M.TECH - PT

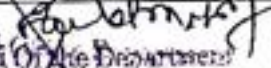
 Head of the Department
 Department of Electronics and
 Communication Engineering
 Ponnaiyah Ramajayam Institute of
 Science and Technology (PRIST)
 Ponnaiyah Ramajayam Institute of
 Science and Technology (PRIST)
 Ponnaiyah Ramajayam Institute of
 Science and Technology (PRIST)
 Ponnaiyah Ramajayam Institute of
 Science and Technology (PRIST)
 Ponnaiyah Ramajayam Institute of
 Science and Technology (PRIST)

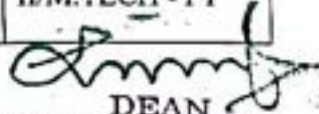
 DEAN
 School of Engineering and Tech.
 Ponnaiyah Ramajayam Institute of
 Science and Technology (PRIST)
 Deemed to be University
 Vallam, Thanjavur - 613 403.

41.	YASHWANTH KUMAR J	2201CO2821	II/M.TECH - PT
42.	S.GUNAL	2101CO28001	III/M.TECH - PT
43.	A.SUNDARI	2101CO28002	III/M.TECH - PT
44.	V.VETRI	2101CO28003	III/M.TECH - PT
45.	J.JOSWA	2101CO28004	III/M.TECH - PT
46.	T.VEENAI	2101CO28005	III/M.TECH - PT
47.	D.MUGIL	2101CO28006	III/M.TECH - PT
48.	S.VANTHANA	2101CO28007	III/M.TECH - PT
49.	T.YUVA	2101CO28008	III/M.TECH - PT
50.	KUMARATHI U	2101CO28009	III/M.TECH - PT
51.	MANIKANDAN A	2101CO28010	III/M.TECH - PT
52.	VEERAVEL I	2101CO28011	III/M.TECH - PT
53.	RAJENDRAN S	2101CO28012	III/M.TECH - PT
54.	MANIBAHARATHI L	2101CO28013	III/M.TECH - PT
55.	NAGARAJAN P	2101CO28014	III/M.TECH - PT
56.	DHANYA SREE S	2101CO28015	III/M.TECH - PT
57.	SUDAR OLI M	2101CO28016	III/M.TECH - PT
58.	MAYA G	2101CO28017	III/M.TECH - PT
59.	MAYURI L	2101CO28018	III/M.TECH - PT

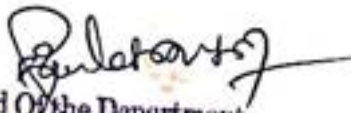
 Head Of the Department
 Department Of Electronics and
 Communication Engineering
 Ponnaiyah Ramajayam Institute of
 Science & Technology (PRIST)
 (Institution Deemed to be University
 - 3 of the UGC Act, 1956)
 TUVANJAVUR - 613 403, TAMIL NADU.

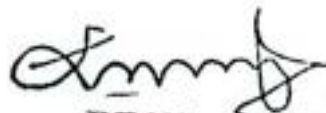
 DEAN
 School of Engineering and Tect.
 Ponnaiyah Ramajayam Institute of
 Science and Technology (PRIST)
 Deemed to be University
 Vallam, Thanjavur - 613,403.



PONNAIYAH RAMAJAYAM INSTITUTE OF SCIENCE & TECHNOLOGY (PRIST)
 Declared as DEEMED TO BE UNIVERSITY
 Utk 3 of UGC Act, 1956

**SCHOOL OF ENGINEERING AND TECHNOLOGY
 DEPARTMENT OF ECE
 ACADEMIC YEAR 2023-2024**

ADD ON COURSE ON INTRODUCTION TO LAB VIEW

S. NO	NAME	REG NO	6-2-24	7-2-24	8-2-24	9-2-24	10-2-24	13-2-24	2-3-24	5-3-24	6-3-24	7-3-24	8-3-24	2-4-24	5-4-24	6-4-24	9-4-24	
1	PRAGADEESH R	2201ECMG1001	/	/	/	/	/	/	/	/	/	/	/	/	/	/	/	
2	SANTOSH V	2201ECMG1002	/	/	/	/	/	a	/	/	/	/	/	/	/	/	/	
3	AKASH D	2201EC13101	/	/	/	/	/	/	/	/	/	/	/	/	/	/	/	
4	ARNESH S	2201EC10102	/	a	/	/	/	/	/	/	/	/	/	/	/	/	/	
5	RAVICIANDRAN B	2201EC10103	/	/	/	/	/	/	/	/	/	/	/	/	/	/	/	
6	MAHENDRAN B	2201EC10104	/	a	/	/	/	/	/	/	/	/	/	/	/	/	/	
7	BHARATHI E	2201EC10105	/	/	/	/	/	/	/	/	/	/	/	/	/	/	/	
8	THANGGARASU R	2201EC10106	/	a	/	/	/	/	/	/	/	/	/	/	/	/	/	
9	BALASUBRAMANIYAN S	2201EC10107	/	/	/	/	/	/	/	/	/	/	/	/	/	/	/	
10	MOHAN G	2201EC10108	/	/	/	/	/	/	/	/	/	/	/	/	/	/	/	
11	MATHAN S	2201EC10109	/	/	/	/	/	/	/	/	/	/	/	/	/	/	/	
12	SARAN V	2201EC10110	/	/	/	/	/	/	b	/	/	/	/	/	/	/	/	
13	LOKESH S	2201EC10111	/	/	/	/	/	/	/	/	/	/	/	/	/	/	/	
14	KANAPATHI V	2201EC10112	/	/	/	/	/	/	/	/	/	/	/	/	/	/	/	
15	VEERA SELVAM T	2201EC10113	/	/	/	/	/	/	/	/	/	/	/	/	/	/	/	
16	VEERA KUMAR	2201EC10114	/	/	/	/	/	/	/	/	/	/	/	/	/	/	/	
17	KARTHIK S	2201EC10115	/	/	/	/	/	/	/	/	/	/	/	/	/	/	/	
18	ARUN B	2201EC10116	/	/	/	/	/	/	/	/	/	/	/	/	/	/	/	
19	HARISH D	2201EC10117	/	/	/	/	/	/	/	/	/	/	/	/	/	/	/	
20	NIRMAL FRANCES	2201EC10118	/	/	/	/	/	/	/	/	/	/	/	/	/	/	/	
21	MEENA R	2201EC10119	/	/	/	/	/	/	/	/	/	a	/	/	/	a	/	
22	VAIDHEHI R	2201EC10120	/	/	/	/	/	/	/	/	/	/	/	/	/	/	/	
23	MANIKANDAN P	2201EC10121	/	/	/	/	/	/	/	/	/	/	/	/	/	/	/	
24	SIVARANJANI V	2201EC10122	/	/	/	/	/	/	/	/	/	/	/	/	/	/	/	
25	SHARMILA S	2201EC10123	/	/	/	/	/	/	/	/	/	/	/	/	/	/	/	
26	DIVIDYANESHWARI R	2201EC10124	/	/	/	/	/	/	/	/	/	/	/	/	/	/	/	
27	SARANYA B	2201EC10125	/	/	/	/	/	/	/	/	/	/	/	/	/	/	/	
28	SUGANYA B	2201EC10126	/	/	/	/	/	/	/	/	/	/	/	/	/	/	/	
29	ARUNKUMAR M	2201EC1801	Handwritten notes					/	/	/	/	/	/	/	/	/	/	/
30	SANKAR SUBRAMANIYAN M	2201EC1802	Handwritten notes					/	/	/	/	/	/	/	/	/	/	/
31	AMBALATHI/ARASAN V	2201EC1803	Handwritten notes					/	/	/	/	/	/	/	/	/	/	/
32	SIVAMIYA K	2201EC1804	Handwritten notes					/	/	/	/	/	/	/	/	/	/	/
33	VJAY A	2201EC1805	Handwritten notes					/	/	/	/	/	/	/	/	/	/	/
34	SIVASANGARI E	2201EC1806	Handwritten notes					/	/	/	/	/	/	/	/	/	/	/

Handwritten notes and signatures at the bottom of the table, including the name 'SIVASANGARI E' and 'SCHOOL OF ENGINEERING AND TECHNOLOGY'.

35	PRADEEP M	2201EC1807	/	/	/	/	/	/	/	/	/	/	/	/	/	/	/	/	/	/
36	SUDHA S	2201EC1808	/	/	/	/	/	/	/	/	/	/	/	/	/	/	/	/	/	/
37	BASKAR	2201EC1809	/	/	/	/	/	/	/	/	/	/	/	/	/	/	/	/	/	/
38	KARTHIKA B	2201EC1810	/	/	/	/	/	/	/	/	/	/	/	/	/	/	/	/	/	/
39	ABIRAMI U	2201EC1811	/	/	/	/	/	/	/	/	/	/	/	/	/	/	/	/	/	/
40	NILOFORE NISHA	2201EC1812	/	/	/	/	/	/	/	/	/	/	/	/	/	/	/	/	/	/
41	AVANTHIKA B	2201EC1813	/	/	/	/	/	/	/	/	/	/	/	/	/	/	/	/	/	/
42	DEVI S	2201EC1814	/	/	/	/	/	/	/	/	/	/	/	/	/	/	/	/	/	/
43	RAVIKAMAL S	2201EC1815	/	/	/	/	/	/	/	/	/	/	/	/	/	/	/	/	/	/
44	KAMALESH V	2201EC1816	/	/	/	/	/	/	/	/	/	/	/	/	/	/	/	/	/	/
45	KRISHNAN V	2201EC1817	/	/	/	/	/	/	/	/	/	/	/	/	/	/	/	/	/	/
46	VIVEK M	2201EC1818	/	/	/	/	/	/	/	/	/	/	/	/	/	/	/	/	/	/
47	MUTHALAKAN D	2201EC1819	/	/	/	/	/	/	/	/	/	/	/	/	/	/	/	/	/	/
48	ARUNASALAM M	2201EC1820	/	/	/	/	/	/	/	/	/	/	/	/	/	/	/	/	/	/
49	DHARANI A	2201EC1821	/	/	/	/	/	/	/	/	/	/	/	/	/	/	/	/	/	/
50	ARINDHAR C	2201EC1822	/	/	/	/	/	/	/	/	/	/	/	/	/	/	/	/	/	/
51	BALA G	2201EC1823	/	/	/	/	/	/	/	/	/	/	/	/	/	/	/	/	/	/
52	JAISHANKAR S	2201EC1824	/	/	/	/	/	/	/	/	/	/	/	/	/	/	/	/	/	/
53	NAVIN S	2201EC1825	/	/	/	/	/	/	/	/	/	/	/	/	/	/	/	/	/	/
54	STALIN V	2201EC1826	/	/	/	/	/	/	/	/	/	/	/	/	/	/	/	/	/	/
55	PRABAKARAN P	2201EC1827	/	/	/	/	/	/	/	/	/	/	/	/	/	/	/	/	/	/
56	T.AMUDHA	2201EC1828	/	/	/	/	/	/	/	/	/	/	/	/	/	/	/	/	/	/
57	V.SUDEHA	2201EC1829	/	/	/	/	/	/	/	/	/	/	/	/	/	/	/	/	/	/
58	M.VIVEK	2201EC1830	/	/	/	/	/	/	/	/	/	/	/	/	/	/	/	/	/	/
59	V.SAATVIK	2201EC1831	/	/	/	/	/	/	/	/	/	/	/	/	/	/	/	/	/	/
60	R.AVANTHIKA	2201EC1832	/	/	/	/	/	/	/	/	/	/	/	/	/	/	/	/	/	/
61	S.DEEVKA	2201EC1833	/	/	/	/	/	/	/	/	/	/	/	/	/	/	/	/	/	/
62	YUVARANJ.P.	2201EC1834	/	/	/	/	/	/	/	/	/	/	/	/	/	/	/	/	/	/
63	MAHESHWARLH	2201EC1835	/	/	/	/	/	/	/	/	/	/	/	/	/	/	/	/	/	/
64	DHEENSH.H	2201EC1836	/	/	/	/	/	/	/	/	/	/	/	/	/	/	/	/	/	/
65	MURALI.D	2201EC1837	/	/	/	/	/	/	/	/	/	/	/	/	/	/	/	/	/	/
66	SAKTHIVEI.D	2201EC1838	/	/	/	/	/	/	/	/	/	/	/	/	/	/	/	/	/	/
67	VINDHI KUMAR	2201EC1839	/	/	/	/	/	/	/	/	/	/	/	/	/	/	/	/	/	/
68	SANGEETHA.V	2201EC1840	/	/	/	/	/	/	/	/	/	/	/	/	/	/	/	/	/	/
69	SARITHA	2201EC1841	/	/	/	/	/	/	/	/	/	/	/	/	/	/	/	/	/	/
70	SARAVANAKUMAR.U	2201EC1842	/	/	/	/	/	/	/	/	/	/	/	/	/	/	/	/	/	/
71	R.RAKESH	2201EC1843	/	/	/	/	/	/	/	/	/	/	/	/	/	/	/	/	/	/
72	S.BABU	2201EC1844	/	/	/	/	/	/	/	/	/	/	/	/	/	/	/	/	/	/
73	MEENAKSHI	2201EC1845	/	/	/	/	/	/	/	/	/	/	/	/	/	/	/	/	/	/
74	SUNDAR R	2201EC1846	/	/	/	/	/	/	/	/	/	/	/	/	/	/	/	/	/	/
75	SANIAY KANNAN G	2201EC1847	/	/	/	/	/	/	/	/	/	/	/	/	/	/	/	/	/	/
76	HARJITH U	2201EC1848	/	/	/	/	/	/	/	/	/	/	/	/	/	/	/	/	/	/
77	MAAMANNAN M	2201EC1849	/	/	/	/	/	/	/	/	/	/	/	/	/	/	/	/	/	/
78	UDHYANITHI S	2201EC1850	/	/	/	/	/	/	/	/	/	/	/	/	/	/	/	/	/	/
79	JASHIKA D	2201CO20201	/	/	/	/	/	/	/	/	/	/	/	/	/	/	/	/	/	/

81	KARAN PANDIYAN	2301CO20202	/	/	/	/	/	/	/	/	/	/	/	/	/	/	/	/	/	/	/
81	M. RAJ KUMAR	2301CO20203	/	/	/	/	/	/	/	/	/	/	/	/	/	/	/	/	/	/	/
82	ANBUSELVK	2301CO20204	/	a	/	/	/	/	/	/	/	/	/	/	/	/	/	/	/	/	/
83	KARTHIK P	2301CO20205	/	/	/	/	/	/	/	/	/	/	/	/	/	/	/	/	/	/	/
84	LODISHJ	2301CO20206	/	/	/	/	/	/	/	/	/	/	/	/	/	/	/	/	/	/	/
85	ASWINJ	2301CO20207	/	/	/	/	/	/	/	/	/	/	/	/	/	/	/	/	/	/	/
86	P. GOKULA KRISHNAN	2301CO20208	/	/	/	/	/	/	/	/	/	/	/	/	/	/	/	/	/	/	/
87	JENITH V	2301CO20209	/	/	/	/	/	/	/	/	/	/	/	/	/	/	/	/	/	/	/
88	VELLACHIAMIY S	2301CO20210	/	/	/	/	/	/	/	/	/	/	/	/	/	/	/	/	/	/	/
89	JANANI C	2301CO20211	/	/	/	/	/	/	/	/	/	/	/	/	/	/	/	/	/	/	/
90	RAMYA R	2301CO20212	/	/	/	/	/	/	/	/	/	/	/	/	/	/	/	/	/	/	/
91	JAGANATHAN H	2301CO20213	/	/	/	/	/	/	/	/	/	/	/	/	/	/	/	/	/	/	/
92	MUTHUKON A	2301CO20214	/	/	/	/	/	/	/	/	/	/	/	/	/	/	/	/	/	/	/
93	JAGANATHAN H	2301CO20215	/	/	/	/	/	/	/	/	/	/	/	/	/	/	/	/	/	/	/
94	MUTHUKON A	2301CO20216	/	/	/	/	/	/	/	/	/	/	/	/	/	/	/	/	/	/	/
95	SHEELA R	2301CO20217	/	/	/	/	/	/	/	/	/	/	/	/	/	/	/	/	/	/	/
96	JAFFER SADIQ M	2301CO20218	/	/	/	/	/	/	/	/	/	/	/	/	/	/	/	/	/	/	a
97	P. GOKULA KRISHNAN	2301CO20219	/	/	/	/	/	/	/	/	/	/	/	/	/	/	/	/	/	/	/
98	M. F. AHMED RAMEZ	2301CO20220	/	/	/	/	/	/	/	/	/	/	/	/	/	/	/	/	/	/	/
99	ARUN M.	2301CO20221	/	/	/	/	/	/	/	/	/	/	/	/	/	/	/	/	/	/	/
100	V. MURUGAN	2301CO20222	/	/	/	/	/	/	/	/	/	/	/	/	/	/	/	/	/	/	/

STAFF INCHARGE

Head of the Department
Department of Electronics and
Communication Engineering,
Ponnaiyan Ramaswamy Institute of
Science & Technology (PRIST)
Harambura Damodar, Taluk, Chittoor
District, Andhra Pradesh
THANJAVUR - 612 026, TELANGANA.

DEAN
School of Engineering and Tech.
Ponnaiyan Ramaswamy Institute of
Science and Technology (PRIST)
Deemed to be University
Vijayam, Thanjavur-612 026, TN.



PONNAIYAH RAMAJAYAM INSTITUTE OF SCIENCE & TECHNOLOGY (PRIST)
 GRANTED AS DEEMED TO BE UNIVERSITY
 UFA 3 BY UGC A&L 1960

SCHOOL OF ENGINEERING AND TECHNOLOGY
DEPARTMENT OF ECE
ACADEMIC YEAR 2023-2024

ADD ON COURSE ON EMBEDDED USING RASPBERRY PI

S. NO	NAME	REG NO	6/02	7/02	8/02	9/02	14/2	15/2	21/2	22/2	28/2	29/2	5/3	6/3	12/3	13/3	19/3	20/3	26/3	27/3
1	DEEPIKA C	2301CO28101	/	/	/	/	/	/	/	/	/	/	/	/	/	/	/	/	/	/
2	DISAN R	2301CO28102	/	/	/	/	/	/	a	/	/	/	/	/	/	/	/	/	/	/
3	ANURATHA N	2301CO28103	/	/	/	/	/	/	/	/	/	/	/	/	/	/	/	/	/	/
4	ANUKADHA D	2301CO28104	/	/	/	/	/	/	/	/	/	/	/	/	/	/	/	/	/	/
5	DHIVYA PRABA A	2301CO28105	/	/	/	/	/	/	/	/	/	/	/	/	/	/	/	/	/	/
6	ARUN SUBRAJAN E	2301CO28106	/	/	/	/	/	/	/	/	/	/	/	/	/	/	/	/	/	/
7	ANBUSEZ VAN M	2301CO28107	/	/	/	/	/	/	/	/	/	/	/	/	/	/	/	/	/	/
8	AIDOKIA RAJ S	2301CO28108	/	/	/	/	/	/	/	/	/	/	/	/	/	/	/	/	/	/
9	J. MANIGANDAN	2301CO28109	/	/	/	/	/	/	/	/	/	/	/	/	/	/	/	/	/	/
10	ARUNA L	2301CO28110	/	/	/	/	/	/	/	/	/	/	/	/	/	/	/	/	/	/
11	ADINESH A	2301CO28111	/	/	/	/	/	/	/	/	/	/	/	/	/	/	/	/	/	/
12	CHANDRU S	2301CO28112	/	/	/	/	/	/	/	/	/	/	/	/	/	/	/	/	/	/
13	DINESH K	2301CO28113	/	/	/	/	/	/	a	/	/	/	/	/	/	/	/	/	/	/
14	ELANKUMARAN R	2301CO28114	/	/	/	/	/	/	/	/	/	/	/	/	/	/	/	/	/	/
15	JACKSON U	2301CO28115	/	/	/	/	/	/	/	/	/	/	/	/	/	/	/	/	/	/
16	THANGDURAI T	2301CO28116	/	/	/	/	/	/	/	/	/	/	/	/	/	/	/	/	/	/
17	SELVI	2301CO28117	/	a	/	/	/	/	/	/	/	/	/	/	/	/	/	/	/	/
18	SENBAJAMP	2301CO28118	/	/	/	/	/	/	/	/	/	/	/	/	/	/	/	/	/	/
19	R. PRMEYA	2301CO28119	/	/	/	/	/	/	/	/	/	/	/	/	/	/	/	/	/	/
20	R. RAJAPRIYA	2301CO28120	/	/	/	/	/	/	/	/	/	/	/	/	/	/	/	/	/	/
21	PALANIVIL K.	2201CO2801	/	/	/	/	/	/	/	/	/	/	/	/	/	/	/	/	/	/
22	AMRUTHAN B	2201CO2802	/	/	/	/	/	/	/	/	/	/	/	/	/	/	/	/	/	/
23	BALU J	2201CO2803	/	/	/	/	/	/	/	/	/	/	/	/	/	/	/	/	/	/
24	HARIKISHORE T	2201CO2804	/	/	/	/	/	/	/	/	/	/	/	/	/	/	/	/	/	/
25	CHINNAYAN K	2201CO2805	/	/	/	/	/	/	a	/	/	/	/	/	/	/	/	/	/	/
26	DHEEM SINGHI	2201CO2806	/	/	/	/	/	/	/	/	/	/	/	/	/	/	/	/	/	/
27	VIDHYA LAKSHMI H	2201CO2807	/	/	/	/	/	/	/	/	/	/	/	/	/	/	/	/	/	/
28	HARSHATI S	2201CO2808	/	/	/	/	/	/	/	/	/	/	/	/	/	/	/	/	/	/
29	ASIF SULTAN J	2201CO2809	/	/	/	/	/	/	/	/	/	/	/	/	/	/	/	/	/	/
30	CHRISTOPHER A	2201CO2810	/	/	/	/	/	/	/	/	/	/	/	/	/	/	/	/	/	/
31	JENITH V	2201CO2811	/	/	/	/	/	/	/	/	/	/	/	/	/	/	/	/	/	/
32	VINOTH KANNAN K	2201CO2812	/	/	/	/	/	/	/	/	/	/	/	/	/	/	/	/	/	/
33	LAVANYA B	2201CO2813	/	/	/	/	/	/	/	/	/	/	/	/	/	/	/	/	/	/
34	WILSON FAZIL G	2201CO2814	/	/	/	/	/	/	/	/	/	/	/	/	/	/	/	/	/	/



PONNAIYAN RAMAJAYAM INSTITUTE OF SCIENCE & TECHNOLOGY (PRIST)
GRANTED AS DEEMED TO BE UNIVERSITY BY S & T ORD. ACT, 1986

**SCHOOL OF ENGINEERING AND TECHNOLOGY
 DEPARTMENT OF ECE
 ACADEMIC YEAR 2023-2024
 ADD ON COURSE ON INTRODUCTION TO R-PROGRAMMING**

S.NO	NAME	REG NO	A-1	B-1	C-1	D-1	E-1	F-1	G-1	H-1	I-1	J-1	K-1	L-1	M-1	N-1	O-1	P-1	Q-1	R-1
1	ROHINI C	2201EC13101	/	/	/	/	/	/	/	/	/	/	/	/	/	/	/	/	/	/
2	RAMYA T	2201EC13102	a	/	/	/	/	/	/	/	/	/	/	/	/	/	/	/	/	/
3	KEERTHIVASAN S	221ECEN31092	/	/	/	/	/	/	/	/	/	/	/	/	/	/	/	/	/	/
4	HARRIPRASANTH S	2101EC10103	/	/	/	/	/	/	/	/	/	/	/	/	/	/	/	/	/	/
5	NARESH U	2101EC10104	/	/	/	/	/	/	/	/	/	/	/	/	/	/	/	/	/	/
6	MOHAMED UWAIS A	2101EC10105	/	/	/	/	/	/	/	/	/	/	/	/	/	/	/	/	/	/
7	NAVEEN KUMAR K	2101EC10106	/	/	/	/	/	/	/	/	/	/	/	/	/	/	/	/	/	/
8	M NANDHINI	2101EC10107	/	/	/	/	/	/	/	/	/	/	/	/	/	/	/	/	/	/
9	DARSHAN V	2101EC10108	/	/	/	/	/	/	/	/	/	/	/	/	/	/	/	/	/	/
10	DHAGATHI SINGH K	2101EC10109	/	/	/	/	/	/	/	/	/	/	/	/	/	/	/	/	/	/
11	KARFER RAHMAN K	2101EC10110	/	/	/	/	/	/	/	/	/	/	/	/	/	/	/	/	/	/
12	MANOJ K	2101EC10111	/	/	/	/	/	/	/	/	/	/	/	/	/	/	/	/	/	/
13	MUKESH S	2101EC10112	/	/	/	/	/	/	/	/	/	/	/	/	/	/	/	/	/	/
14	PRAVEEN B	2101EC10113	/	/	/	/	/	/	/	/	/	/	/	/	/	/	/	/	/	/
15	RAGHU R	2101EC10114	/	/	/	/	/	/	/	/	/	/	/	/	/	/	/	/	/	/
16	RAHUL K	2101EC10115	/	/	/	/	/	/	/	/	/	/	/	/	/	/	/	/	/	/
17	RAJS	2101EC10116	/	a	/	/	/	/	/	/	/	/	/	/	/	/	/	/	/	/
18	RAM LAKSHMANAN S	2101EC10117	/	/	/	/	/	/	/	/	/	/	/	/	/	/	/	/	/	/
19	SANTHOSH R	2101EC10118	/	/	/	/	/	/	/	/	/	/	/	/	/	/	/	/	/	/
20	KARTHIKEYAN V	2101EC10119	/	/	/	/	/	/	/	/	/	/	/	/	/	/	/	a	/	/
21	MOHAMED FAISEL A	2101EC10120	/	/	/	/	/	/	/	/	/	/	/	/	/	/	/	/	/	/
22	MOHAMED IRFAN K M	2101EC10121	/	/	/	/	/	/	/	/	/	/	/	/	/	/	/	/	/	/
23	SANJAI K	2101EC10122	/	/	/	/	/	/	/	/	/	/	/	/	/	/	/	/	/	/
24	THAMILARASAN D	2101EC10123	/	/	/	/	/	/	/	/	/	/	/	/	/	/	/	/	/	/
25	VIGNESH R M	2101EC10124	/	/	/	/	/	/	/	/	/	/	/	/	/	/	/	/	/	/
26	VIMAL M	2101EC10125	/	/	/	/	/	/	/	/	/	/	/	/	/	/	/	/	/	/
27	VISHVADHARSHINI M	2101EC10126	/	/	/	/	/	/	/	/	/	/	/	/	/	/	/	/	/	/
28	ABHIJITH P	2101EC10127	/	/	/	/	/	/	/	/	/	/	/	/	/	/	/	/	/	/
29	ARISHA	2101EC10128	/	/	/	/	/	/	/	/	/	/	/	/	/	/	/	/	/	/
30	AAKASHRAM J	2101EC10129	/	/	/	/	/	/	/	/	/	/	/	/	/	/	/	/	/	/
31	ABDUL RAHMAN R	2101EC10130	/	/	/	/	/	/	/	/	/	/	/	/	/	/	/	/	/	/
32	DIVYADHARSHINI K	2101EC10131	/	/	/	/	/	/	/	/	/	/	/	/	/	/	/	/	/	/
33	ESWARAN S	2101EC10132	/	/	/	/	/	/	/	/	/	/	/	/	/	/	/	/	/	/
34	HARISH K	2101EC10133	/	/	/	/	/	/	/	/	/	/	/	/	/	/	/	/	/	/

Approved by UGC Act, 1956
 - 613 403, TAMB. NAD.

PONNAIYAH RAMAJAYAM INSTITUTION

35	ARUNKUMAR A	2101EC10134	/	/	/	/	/	/	/	/	/	/	/	/	/	/	/
36	ROYAL M	2101EC10135	/	/	/	/	/	/	/	/	/	/	/	/	/	/	/
37	PRADEEP K	2101EC10136	/	/	/	/	/	/	/	/	/	/	/	/	/	/	a
38	SEVANANTHAM K	2101EC10137	a	/	/	/	/	/	/	/	/	/	/	/	/	/	a
39	SURIYA T	2101EC10138	/	/	/	/	/	/	/	/	/	/	/	/	/	/	/
40	VIGNESHR	2101EC10139	/	/	/	/	/	/	/	/	/	/	/	/	/	/	/
41	ARAVINDEH	2101EC10140	/	/	/	/	/	/	/	/	/	/	/	/	/	/	/
42	RAJAKUMAR G	2101EC10141	/	/	/	/	/	/	/	/	/	/	/	/	/	/	/
43	MURUGESH H	2101EC10142	/	/	/	/	/	/	/	/	/	a	/	/	/	/	/
44	HARI HANKEE J	2101EC10143	/	/	/	/	/	/	/	/	/	/	/	/	/	/	/
45	KUMAR E	2101EC10144	/	/	/	/	/	/	/	/	/	/	/	/	/	/	/
46	KAMESHG	2101EC10145	/	/	/	/	/	/	/	/	/	/	/	/	/	/	/
47	GANAPATHY PRABHU	2101EC10146	/	/	/	/	/	/	/	/	/	/	/	/	/	/	/
48	INDIAVI J	2101EC10147	/	/	/	/	/	/	/	/	/	/	/	/	/	/	/
49	RAGHAVAN K	2101EC10148	/	/	/	/	/	/	/	/	/	/	/	/	/	/	/
50	KINHOJI T	2101EC10149	/	/	/	/	/	/	/	/	/	/	/	/	/	/	/
51	GUHANANTHAM V	2101EC10150	/	/	/	/	/	/	/	/	/	/	/	/	/	/	/
52	S.ARIF AHMED	2101EC10151	/	/	/	/	/	/	/	/	/	/	/	/	/	/	/
53	K.J.DGAVIKIRAMAN	2101EC10152	/	/	/	/	/	/	/	/	/	/	/	/	/	/	/
54	K.SRIDAM	2101EC10153	/	/	/	/	/	/	/	/	/	/	/	/	/	/	/
55	REJGAN S	2101EC10154	/	/	/	/	/	/	/	/	/	/	/	/	/	/	/
56	H.SARAVANAN	2101EC10155	/	/	/	/	/	/	/	/	/	/	/	/	/	/	/
57	MUHAMMAD ANAS A	2101EC10156	/	/	/	/	/	/	/	/	/	/	/	/	/	/	/
58	RAMYA L	2101EC10157	/	/	/	/	/	/	/	/	/	/	/	/	/	/	/
59	SNEHA S	2101EC10158	/	/	/	/	/	/	/	/	/	/	/	/	/	/	/
60	SWETHA P	2101EC10159	/	/	/	/	/	/	/	/	/	/	/	/	/	/	/
61	N.AELIN KUMAR	2101EC10160	/	/	/	/	/	/	/	/	/	/	/	/	/	/	/
62	M.AHILJA	2101EC10161	/	/	/	/	/	/	/	/	/	/	/	/	/	/	/
63	ABDUL LATIF H	2101EC10162	/	/	/	/	/	/	/	/	/	/	/	/	/	/	/
64	SUNEELA	2101EC10163	/	/	/	/	/	/	/	/	/	/	/	/	/	/	/
65	T.AESA BEGUM	2101EC10164	/	/	/	/	/	/	/	/	/	/	/	/	/	/	a
66	R.AJAVINDHAN	2101EC10165	/	/	/	/	/	/	/	/	/	/	/	/	/	/	/
67	S.JAYAM KASTHURI	2101EC10166	/	/	/	/	/	/	/	/	/	/	/	/	/	/	/
68	T.JAYASHI	2101EC10167	/	/	/	/	/	/	/	/	/	/	/	/	/	/	/
69	A.MARJAKARISHMA	2101EC10168	/	/	/	/	/	/	/	/	/	/	/	/	/	/	/
70	T.SOEL SOLOMON	2101EC10169	/	/	/	/	/	/	/	/	/	/	/	/	/	/	/
71	G.REUSHMITHA	2101EC10170	/	/	/	/	/	/	/	/	/	/	/	/	/	/	/
72	S.VIGNESHWARAN	2101EC10171	/	/	/	/	/	/	/	/	/	/	/	/	/	/	/
73	R.SWATHI	2101EC10172	/	/	/	/	/	/	/	/	/	/	/	/	/	/	/
74	N.SAHAMMED ARIFF	2101EC10173	/	/	/	/	/	/	/	/	/	/	/	/	/	/	/
75	A.ANUSHA	2101EC10174	/	/	/	/	/	/	/	/	/	/	/	/	/	/	/
76	VANSI	2101EC10175	/	/	/	/	/	/	/	/	/	/	/	/	/	/	/
77	SUMITHA K	2101EC10176	/	/	/	/	/	/	/	/	/	/	/	/	/	/	/
78	PARTHASALATHY I	2101EC10177	/	/	/	/	/	/	/	/	/	/	/	/	/	/	/
79	ARUL KARTHEM	2101EC10178	/	/	/	/	/	/	/	/	/	/	/	/	/	/	/

81	ZENTHE M	2101EC18130	/	/	/	/	/	/	/	/	/	/	/	/	/	/	/	/	/	/
82	VINOTH S	2101EC18131	/	/	/	/	/	/	/	/	/	/	/	/	/	/	/	/	/	/
83	PADMANARAN S	2101EC18132	/	/	/	/	/	/	/	/	/	/	/	/	/	/	/	/	/	/
84	SIYAMALAMBIGAI O	2101EC18133	/	/	/	/	/	/	/	/	/	/	/	/	/	/	/	/	/	/
85	TAMILVAANAN R	2101EC18134	/	/	/	/	/	/	/	/	/	/	/	/	/	/	/	/	/	/
86	BOOBALAN R	2101EC18135	/	/	/	/	/	/	/	/	/	/	/	/	/	/	/	/	/	/
87	NEDUNCHEZHIAN SR	2101EC18136	/	/	/	/	/	/	/	/	/	/	/	/	/	/	/	/	/	/
88	BALAKUMAR P	2101EC18137	/	/	/	/	/	/	/	/	/	/	/	/	/	/	/	/	/	/
89	SHANTHANU B	2101EC18138	/	/	/	/	/	/	/	/	/	/	/	/	/	/	/	/	/	/
90	DIJANASEKARAN K	2101EC18139	/	/	/	/	/	/	/	/	/	/	/	/	/	/	/	/	/	/
91	ELANTHARAYAN SU	2101EC18140	/	/	/	/	/	/	/	/	/	/	/	/	/	/	/	/	/	/
92	KARTHIKEYAN B	2101EC18141	/	/	/	/	/	/	/	/	/	/	/	/	/	/	/	/	/	/
93	SOUNDARAPANDI K	2101EC18142	/	/	/	/	/	/	/	/	/	/	/	/	/	/	/	/	/	/
94	DEVAN H	2101EC18143	/	/	/	/	/	/	/	/	/	/	/	/	/	/	/	/	/	/
95	VASANTH KD	2101EC18144	/	/	/	/	/	/	/	/	/	/	/	/	/	/	/	/	/	/
95	GUNASEELAN B	2101EC18145	/	/	/	/	/	/	/	/	/	/	/	/	/	/	/	/	/	/

[Signature]
STAFF INCHARGE

[Signature]
HOD
Head of the Department
Department of Electronics and
Communications Engineering
Ponnaiyappan Rajaratnam Institute of
Science & Technology (PRIST)
Pondicherry
Deemed to be University
3 of 100, LSC, Apt. 194A
TIRUVARUR - 613 003, TEL: 0432-2611000

[Signature]
DEAN
DEAN
School of Engineering and Tech.
Ponnaiyappan Rajaratnam Institute of
Science and Technology (PRIST)
Deemed to be University
Vullam, Thanjavur - 613 403.



PONNAIYAH RAMAJAYAM INSTITUTE OF SCIENCE & TECHNOLOGY (PRIST)
 Declared as Deemed to be University
 UIR & AIU Act, 1980

**SCHOOL OF ENGINEERING AND TECHNOLOGY
 DEPARTMENT OF ECE
 ACADEMIC YEAR 2023-2024
 ADD ON COURSE ON INTRODUCTION TO MICROCONTROLLER**

S NO	NAME	REG NO	4-7	5-7	6-7	8-7	11-7	12-7	2-8	4-8	5-8	6-8	1-9	2-9	5-9	6-9	7-9
1	SATHESH M.	2001EC1001	/	/	/	/	/	/	/	/	/	/	/	/	/	/	/
2	MATHAN B.	2001EC1002	/	/	/	/	/	/	/	/	/	/	/	/	/	/	/
3	S. EVANGELINE RENILDA	2001EC1003	/	/	/	/	/	/	/	/	/	/	/	/	/	/	/
4	ROBINSON M.	2001EC1004	/	/	/	/	/	/	/	/	/	/	/	/	/	/	/
5	K. JAMUNA	2001EC1005	/	/	/	/	/	/	/	/	/	/	/	/	/	/	/
6	R.SADHESH	2001EC1006	/	/	/	/	/	/	/	/	/	/	/	/	/	/	/
7	B. VINAY REDDY	2001EC1007	/	/	/	/	/	/	/	/	/	/	/	/	/	/	/
8	SRINIVASAN G.	2001EC1301	/	/	/	/	/	/	/	/	/	/	/	/	/	/	/
9	RAJARAMALINGESHWARAN M.	2001EC1302	/	/	/	/	/	/	/	/	/	/	/	/	/	/	/
10	SANJIVI BALAJI M.	2001EC1303	/	/	/	/	/	/	/	/	/	/	/	/	/	/	/
11	YOGASARATHY K.	2001EC1304	/	/	/	/	/	/	/	/	/	/	/	/	/	/	/
12	PRAVEEN S	2001EC1008	/	/	/	/	/	/	/	/	/	/	/	/	/	/	/
13	NISHANTH S	2001EC1009	/	/	/	/	/	/	/	/	/	/	/	/	/	/	/
14	REVAATH S	2001EC1010	/	/	/	/	/	/	/	/	/	/	/	/	/	/	/
15	MOHAMMED YASHIK K	2001EC1011	/	/	/	/	/	/	/	/	/	/	/	/	/	/	/
16	LOKESILA	2001EC1012	/	/	/	/	/	/	/	/	/	/	/	/	/	/	/
17	THEERUKUMARAN C	2001EC1013	/	/	/	/	/	/	/	/	/	/	/	/	/	/	/
18	RAGUL R	2001EC1014	/	/	/	/	/	/	/	/	/	/	/	/	/	/	/
19	VEERAMANLA	2001EC1015	/	/	/	/	/	/	/	/	/	/	/	/	/	/	/
20	SALAMAN P	2001EC1016	/	/	/	/	/	/	/	/	/	/	/	/	/	/	/
21	MANIKANDAN E	2001EC1017	/	/	/	/	/	/	/	/	/	/	/	/	/	/	/
22	SRINIVASAN G.	2001EC1018	/	/	/	/	/	/	/	/	/	/	/	/	/	/	/
23	RAJA RAMALINGESHWARAN M.	2001EC1019	/	/	/	/	/	/	/	/	/	/	/	/	/	/	/
24	YOGASARATHY S.	2001EC1020	/	/	/	/	/	/	/	/	/	/	/	/	/	/	/
25	SANJEEVI BALAJI M.	2001EC1021	/	/	/	/	/	/	/	/	/	/	/	/	/	/	/
26	K. AKASH	2001EC1022	/	/	/	/	/	/	/	/	/	/	/	/	/	/	/
27	S.SATYA PRAKASH	2001EC1023	/	/	/	/	/	/	/	/	/	/	/	/	/	/	/
28	D.AJAYKUMAR	2001EC1024	/	/	/	/	/	/	/	/	/	/	/	/	/	/	/
29	S. YOCESH	2001EC1025	/	/	/	/	/	/	/	/	/	/	/	/	/	/	/
30	V. VIJAY ANAND	2001EC1026	/	/	/	/	/	/	/	/	/	/	/	/	/	/	/
31	GUNA SUNDHAR S	2001EC1027	/	/	/	/	/	/	/	/	/	/	/	/	/	/	/
32	B. PARTHASARATHI	2001EC1028	/	/	/	/	/	/	/	/	/	/	/	/	/	/	/
33	R. VIKRAMAN	2001EC1029	/	/	/	/	/	/	/	/	/	/	/	/	/	/	/
34	GOVINDASWAMY V.	2001EC1030	/	/	/	/	/	/	/	/	/	/	/	/	/	/	/

Head of the Department
 Department of Electronics and Communication Engineering
 Ponnaiyah Ramajayam Institute of Science and Technology (PRIST)
 Declared as Deemed to be University
 UIR & AIU Act, 1980

35	KANNAN S	2001EC1001	/	/	/	/	/	/	/	/	/	/	/	/	/	/	/	/	/
36	KRISHNA S	2001EC1002	/	/	/	/	/	/	/	/	/	/	/	/	/	/	/	/	/
37	SUNDAR RAJ R	2001EC1003	/	/	/	/	/	/	/	/	/	/	/	/	/	/	/	/	/
38	SIVARAMAN S	2001EC1004	/	/	/	/	/	/	/	/	/	/	/	/	/	/	/	/	/
39	SATHISH S	2001EC1005	/	/	/	/	/	/	/	/	/	/	/	/	/	/	/	/	/
40	DIVYA DHARSHINI T	2001EC1006	/	/	/	/	/	/	/	/	/	/	/	/	/	/	/	/	/
41	BALAMURUGAN B	2001EC1007	/	/	/	/	/	/	/	/	/	/	/	/	/	/	/	/	/
42	GOVINDASWAMY V.	2001EC1008	/	/	/	/	/	/	/	/	/	/	/	/	/	/	/	/	/
43	KAVI P	2001EC1009	/	/	/	/	/	/	/	/	/	/	/	/	/	/	/	/	/
44	IMRAN K	2001EC1040	/	/	/	/	/	/	/	/	/	/	/	/	/	/	/	/	/
45	SIVA A	2001EC1041	/	/	/	/	/	/	/	/	/	/	/	/	/	/	/	/	/
46	PRIYAROHINI M	2001EC1042	/	/	/	/	/	/	/	/	/	/	/	/	/	/	/	/	/
47	RETHINA VEL V	2001EC1043	/	/	/	/	/	/	/	/	/	/	/	/	/	/	/	/	/
48	VAIYADURI S	2001EC1044	/	/	/	/	/	/	/	/	/	/	/	/	/	/	/	/	/
49	JENIFER M	2001EC1045	/	/	/	/	/	/	/	/	/	/	/	/	/	/	/	/	/
50	KEERTHIVASAN N	2001EC1046	/	/	/	/	/	/	/	/	/	/	/	/	/	/	/	/	/
51	SHAMSHUDEENAHAMED J	2001EC1047	/	/	/	/	/	/	/	/	/	/	/	/	/	/	/	/	/
52	MUKILAN S	2001EC1048	/	/	/	/	/	/	/	/	/	/	/	/	/	/	/	/	/
53	SATTIYANATHAN C	2001EC1049	/	/	/	/	/	/	/	/	/	/	/	/	/	/	/	/	/
54	JASMINE BANU P	2001EC1050	/	/	/	/	/	/	/	/	/	/	/	/	/	/	/	/	/
55	MARIMUTHU S	2001EC1051	/	/	/	/	/	/	/	/	/	/	/	/	/	/	/	/	/
56	VETRIVEL VEERAN	2001EC1001	/	/	/	/	/	/	/	/	/	/	/	/	/	/	/	/	/
57	V. VINOTH	2001EC1002	/	/	/	/	/	/	/	/	/	/	/	/	/	/	/	/	/
58	K LOGANAYAKI	2001EC1003	/	/	/	/	/	/	/	/	/	/	/	/	/	/	/	/	/
59	KUMAR RAJA R.	2001EC1004	/	/	/	/	/	/	/	/	/	/	/	/	/	/	/	/	/
60	VENKATESH	2001EC1005	/	/	/	/	/	/	/	/	/	/	/	/	/	/	/	/	/
61	T NALLASIVAN	2001EC1006	/	/	/	/	/	/	/	/	/	/	/	/	/	/	/	/	/
62	P RAJENDRAN	2001EC1007	/	/	/	/	/	/	/	/	/	/	/	/	/	/	/	/	/
63	ASHOK S	2001EC1008	/	/	/	/	/	/	/	/	/	/	/	/	/	/	/	/	/
64	BALAKRISHNAN M.	2001EC1009	/	/	/	/	/	/	/	/	/	/	/	/	/	/	/	/	/
65	PALANIAPPAN A.	2001EC10010	/	/	/	/	/	/	/	/	/	/	/	/	/	/	/	/	/
66	KARTHIKRAJA S.	2001EC10011	/	/	/	/	/	/	/	/	/	/	/	/	/	/	/	/	/
67	ANBALAGAN D.	2001EC10012	/	/	/	/	/	/	/	/	/	/	/	/	/	/	/	/	/
68	DANIEL BALAJI M.	2001EC10013	/	/	/	/	/	/	/	/	/	/	/	/	/	/	/	/	/
69	KRITHIKA A.	2001EC10014	/	/	/	/	/	/	/	/	/	/	/	/	/	/	/	/	/
70	LAXMAN T.	2001EC10015	/	/	/	/	/	/	/	/	/	/	/	/	/	/	/	/	/
71	NILOFER S.	2001EC10016	/	/	/	/	/	/	/	/	/	/	/	/	/	/	/	/	/
72	SURESH R.	2001EC10017	/	/	/	/	/	/	/	/	/	/	/	/	/	/	/	/	/
73	VIVEKANANDAN P.	2001EC10018	/	/	/	/	/	/	/	/	/	/	/	/	/	/	/	/	/
74	K.KARTHIK	2001EC10019	/	/	/	/	/	/	/	/	/	/	/	/	/	/	/	/	/
75	RANCHANDHAR . S	2001EC10020	/	/	/	/	/	/	/	/	/	/	/	/	/	/	/	/	/
76	MOHAN . M	2001EC10021	/	/	/	/	/	/	/	/	/	/	/	/	/	/	/	/	/
77	ARRTHI . R	2201CO2001	/	/	/	/	/	/	/	/	/	/	/	/	/	/	/	/	/
	ABUL DEVI B	2201CO2002	/	/	/	/	/	/	/	/	/	/	/	/	/	/	/	/	/
	RAMYA M		/	/	/	/	/	/	/	/	/	/	/	/	/	/	/	/	/

Sl. No	Name of Staff	Emp. ID No	1	2	3	4	5	6	7	8	9	10	11	12	13	14	15	16	17	18	19	20
82	SARAVANAKUMAR S	2201CO2004	/	/	/	/	/	/	/	/	/	/	/	/	/	/	/	/	/	/	/	/
83	RAKESH J	2201CO2005	/	/	/	/	/	/	/	/	/	/	/	/	/	/	/	/	/	/	/	/
84	KUMAR D	2201CO2006	/	/	/	/	/	/	/	/	/	/	/	/	/	/	/	/	/	/	/	/
85	VEL MURUGAN T	2201CO2007	/	/	/	/	/	/	/	/	/	/	/	/	/	/	/	/	/	/	/	/
86	BABU K	2201CO2008	/	/	/	/	/	/	/	/	/	/	/	/	/	/	/	/	/	/	/	/
87	SENTHIL V	2201CO2009	/	/	/	/	/	/	/	/	/	/	/	/	/	/	/	/	/	/	/	/
88	BALAJI G	2201CO2010	/	/	/	/	/	/	/	/	/	/	/	/	/	/	/	/	/	/	/	/
89	RAJA GURU V	2201CO2011	/	/	/	/	/	/	/	/	/	/	/	/	/	/	/	/	/	/	/	/
90	MURUGESAN C	2201CO2012	/	/	/	/	/	/	/	/	/	/	/	/	/	/	/	/	/	/	/	/
91	MOORTHY D	2201CO2013	/	/	/	/	/	/	/	/	/	/	/	/	/	/	/	/	/	/	/	/
92	MANIVANNAN G	2201CO2014	/	/	/	/	/	/	/	/	/	/	/	/	/	/	/	/	/	/	/	/
93	NANDHAGOPLAKRISHAN G	2201CO2015	/	/	/	/	/	/	/	/	/	/	/	/	/	/	/	/	/	/	/	/
94	YUVAN R	2201CO2016	/	/	/	/	/	/	/	/	/	/	/	/	/	/	/	/	/	/	/	/
95	DURKESH B	2201CO2017	/	/	/	/	/	/	/	/	/	/	/	/	/	/	/	/	/	/	/	/
96	JAGADEESH R	2201CO2018	/	/	/	/	/	/	/	/	/	/	/	/	/	/	/	/	/	/	/	/
97	MADHUMITHA B	2201CO2019	/	/	/	/	/	/	/	/	/	/	/	/	/	/	/	/	/	/	/	/
98	NAVEENA B	2201CO2020	/	/	/	/	/	/	/	/	/	/	/	/	/	/	/	/	/	/	/	/
99	AMRUTHA S	2201CO2021	/	/	/	/	/	/	/	/	/	/	/	/	/	/	/	/	/	/	/	/
		2201CO2022	/	/	/	/	/	/	/	/	/	/	/	/	/	/	/	/	/	/	/	/

[Signature]
STAFF INCHARGE

[Signature]
HOD
 Head Of the Department
 Department of Electronics and
 Communication Engineering
 Ponnaiyah Ramalingam Institute of
 Science and Technology (PRIST)
 Institution Deemed to be University
 in 2 of the UGC Act 1956
 T-433/AVAR - 615 403, TAMIL NADU

[Signature]
DEAN
DEAN
 School of Engineering and Tech,
 Ponnaiyah Ramalingam Institute of
 Science and Technology (PRIST)
 Deemed to be University
 Vadam, Thiruvannamalai - 611 403.



PONNAIYAH RAMAJAYAM INSTITUTE OF SCIENCE & TECHNOLOGY (PRIST)

DEEMED TO BE UNIVERSITY
 UIR 3 of UGC Act, 1956

**SCHOOL OF ENGINEERING AND TECHNOLOGY
 DEPARTMENT OF ECE
 ACADEMIC YEAR 2023-2024
 ADD ON COURSE ON NETWORK DESIGN**

S. NO	NAME	REG NO	4/7	5/7	6/7	8/7	11/7	12/7	2/8	4/8	5/8	6/8	1/9	2/9	5/9	6/9	7/9
1	DEVABATHY S	2301EC18101	a	/	/	/	/	/	/	/	/	/	/	/	/	/	/
2	SWETHA S	2301EC18102	/	/	/	/	/	/	/	/	/	/	/	/	/	/	/
3	UVAN SILANKAR S	2301EC18103	/	/	/	/	/	/	/	/	/	/	/	/	/	/	/
4	AMITH SANKARI H	2301EC18104	/	/	/	/	/	/	/	/	/	/	/	/	/	/	/
5	SELVI G	2301EC18105	/	/	/	/	/	/	/	/	a	/	/	/	/	/	/
6	CHANAKYA SRI R	2301EC18106	/	/	/	/	/	/	/	/	/	/	/	/	/	/	/
7	DURAI ARASAN M	2301EC18107	/	/	/	/	/	/	/	/	/	/	/	/	/	/	/
8	DEENAVATHI H	2301EC18108	/	/	/	/	/	/	/	/	/	/	/	/	/	/	/
9	FENOLYA G	2301EC18109	/	/	/	/	/	/	/	/	/	/	/	/	/	/	/
10	FAIZAL BANU A	2301EC18110	/	/	/	/	/	/	/	/	/	/	/	/	/	/	/
11	GNANAMBIGAI M	2301EC18111	/	/	/	/	/	/	/	/	/	/	/	/	/	/	/
12	GNANAGANAPATHY K	2301EC18112	/	/	/	/	/	/	/	/	/	/	/	/	/	/	/
13	GUNAVATHI J	2301EC18113	/	/	/	/	/	/	/	/	/	/	/	/	/	/	/
14	GEETHA L	2301EC18114	/	/	/	/	/	/	/	/	/	/	/	/	/	/	/
15	HARENI M	2301EC18115	/	/	/	/	/	/	/	/	/	/	/	/	/	/	/
16	LAKSHANA E	2301EC18116	/	/	/	/	/	/	/	/	/	/	/	/	/	/	/
17	LOKAYANAKI K	2301EC18117	/	/	/	/	/	/	/	/	/	/	/	/	/	/	/
18	MARIAM FARVEEN S	2301EC18118	/	/	/	/	a	/	/	/	/	/	/	/	/	/	/
19	MOULAMED RIYAZ M	2301EC18119	/	/	/	/	/	/	/	/	/	/	/	/	/	a	/
20	MURUGAN S	2301EC18120	/	/	/	/	/	/	/	/	/	/	/	/	/	/	/
21	NAVANEETHAM K	2301EC18121	/	/	/	/	/	/	/	/	/	/	/	/	/	/	/
22	NIRMALA D	2301EC18122	/	/	/	/	/	/	/	/	/	/	/	/	/	/	/
23	PERIYANAYAKI H	2301EC18123	/	/	/	/	/	/	/	/	/	/	/	/	/	/	/
24	RAMALINGAM U	2301EC18124	/	/	/	/	/	/	/	/	/	/	/	/	/	/	/
25	RITHIKA P	2301EC18125	/	/	/	/	/	/	/	/	/	/	/	/	/	/	/
26	ROSHINI R	2301EC18126	/	/	/	/	/	/	/	/	/	/	/	/	/	/	/
27	SABARI NIVAS S	2301EC18101	/	/	/	/	/	/	/	/	/	/	/	/	/	/	/
28	KIRANKUMAR A	2301EC18102	/	/	/	/	/	/	/	/	/	/	/	/	/	/	/
29	SANKAR M	2301EC18103	/	/	/	/	/	/	/	/	/	/	/	/	/	/	/
30	BALAJI	2301EC18104	/	/	/	/	/	/	/	/	/	/	/	/	/	/	/
31	VENGATESH S R	2301EC18105	/	/	/	/	/	/	/	/	/	/	/	/	/	/	/
32	BALAJI N A	2301EC18106	/	/	/	/	/	/	/	/	/	/	/	/	/	/	/
33	AANANDHI R	2301EC18107	/	/	/	/	/	/	/	/	/	/	/	/	/	/	/
34	ANANTHA MOORTHY S	2301EC18108	/	/	/	/	/	/	/	/	/	/	/	/	/	/	/

Head of the Department
 Department of Electronics and
 Communication Engineering
 Ponnaiyah Ramajayam Institute of Science and Technology
 Deemed to be University
 UIR 3 of UGC Act, 1956
 Vadam, Thanjavur - 613 403.

81	VENKATA KUMARI B R	2301EC18154	/	/	/	/	/	/	/	/	/	/	/	/	/	/	/	/	/	/
82	VISWANATHAN R	2301EC18155	a	/	/	/	/	/	/	/	/	/	/	/	/	/	/	/	/	/
83	YOGESHWARI M	2301EC18156	/	/	/	/	/	/	/	/	/	/	/	/	/	/	/	/	/	/
		2301EC18157	/	/	/	/	/	/	/	/	/	/	/	/	/	/	/	/	a	/

[Signature]
STAFF IN CHARGE

[Signature]
HOD
Head Of the Department
Department Of Electronics and
Communication Engineering
Ponnlaiyan Ramasamy Institute of
Science & Technology (PRIST)
(Institution Deemed to be University
1975 of the UGC Act 1956)
THANJAVUR - 613 023

[Signature]
DEAN
DEAN
School of Engineering and Tech.
Ponnlaiyan Ramasamy Institute of
Science and Technology (PRIST)
Deemed to be University
Vasam, Thanjavur - 613 403



**PONNAIYAH RAMAJAYAM INSTITUTE OF
SCIENCE & TECHNOLOGY (PRIST)**

Declared as DEEMED-TO-BE-UNIVERSITY
Uir 3 of UGC Act, 1956

Vallam, Thanjavur
(NAAC Accredited)

**VALUE ADDED COURSE
CERTIFICATE OF ATTENDANCE**

This is to certify that Mr/Ms. M. SATHESH of
IV- ECE has successfully attended the
INTRODUCTION TO MICROCONTROLLER Add on course organized by
Department of Electronics and Communication Engineering , School of
Engineering & Technology, PRIST, Thanjavur from 04.07.2023

to 07.09.2023 .

Dean(E&T)

HOD/ECE



PONNAIYAH RAMAJAYAM INSTITUTE OF
SCIENCE & TECHNOLOGY (PRIST)

Declared as DEEMED-TO-BE-UNIVERSITY
Uix 3 of UGC Act, 1956

Vallam, Thanjavur
(NAAC Accredited)

VALUE ADDED COURSE
CERTIFICATE OF ATTENDANCE

This is to certify that Mr/Ms. T. RAMYA of
III ECE has successfully attended the
INTRODUCTION TO R. ROOBIRAMMING Add on course organized by
Department of Electronics and Communication Engineering , School of
Engineering & Technology, PRIST, Thanjavur from 04-07-2023

to 07-09-2023

Dean(E&T)

HOD/ECE



PONNAIYAH RAMAJAYAM INSTITUTE OF
SCIENCE & TECHNOLOGY (PRIST)

Declared as DEEMED-TO-BE-UNIVERSITY
U/s 3 of UGC Act, 1956

Vallam, Thanjavur
(NAAC Accredited)

VALUE ADDED COURSE
CERTIFICATE OF ATTENDANCE

This is to certify that Mr/Ms. S. DEIVABATHY of
I ECE has successfully attended the
NETWORK DESIGN Add on course organized by
Department of Electronics and Communication Engineering , School of
Engineering & Technology, PRIST, Thanjavur from 04.07.2023
to 07.09.2023 .

Dean(E&T)

HOD/ECE



PONNAIYAH RAMAJAYAM INSTITUTE OF
SCIENCE & TECHNOLOGY (PRIST)

Declared as DEEMED-TO-BE-UNIVERSITY
U/s 3 of UGC Act, 1956

Vallam, Thanjavur
(NAAC Accredited)

VALUE ADDED COURSE
CERTIFICATE OF ATTENDANCE

This is to certify that Mr/Ms. R. PRAGADEESH of
II ECE has successfully attended the
INTRODUCTION TO LAB VIEW Add on course organized by
Department of Electronics and Communication Engineering , School of
Engineering & Technology, PRIST, Thanjavur from 06.02.2024

TO 09.04.2024

Dean (E&T)

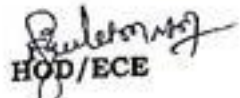
HOD/ECE



PONNAIYAH RAMAJAYAM INSTITUTE OF
SCIENCE & TECHNOLOGY (PRIST)

Declared as DEEMED-TO-BE-UNIVERSITY
U/s 3 of UGC Act, 1956

Vallam, Thanjavur
(NAAC Accredited)

VALUE ADDED COURSE
CERTIFICATE OF ATTENDANCE

This is to certify that Mr/Ms. DEEPIKA.C of
I. M.TECH. COMMUNICATION SYSTEM has successfully attended the
EMBEDDED USING RASPBERRY PI Add on course organized by
Department of Electronics and Communication Engineering, School of
Engineering & Technology, PRIST, Thanjavur from 06.02.2024

to 09.04.2024

Dean (E&T)

HOD/ECE



**PONNAIYAH RAMAJAYAM INSTITUTE OF
SCIENCE & TECHNOLOGY (PRIST)**

Declared as DEEMED-TO-BE-UNIVERSITY
U/s 3 of UGC Act, 1956

CIRCULAR

PRIST /MECH/CIRC/ 2023-2024/ ODD / VALUE-ADDED COURSES /01

DATE: 02.06.2023

It is informed that the ADD-ON COURSES will be conduct from 10.06.2023 to 12.08.2023.

I) CERTIFICATE COURSES

➤ **AUTOMATION IN AGRICULTURE**

Venue: C Block, Seminar Hall.

Timing: 10.00A.M to 4.00P.M

Duration: 45 hrs.

Students from mechanical department those who are interest can enroll their names and course to the HOD on or before 06/06/2023

HOD

Department of Mechanical Engineer
Ponnaiyah Ramajayam Institute of
Science & Technology (PRIST)
(Institution Deemed to be University
U/s 3 of the UGC Act 1956)
THANJAVUR - 613 403, TAMIL NADU.

DEAN

School of Engineering and Tech.
Ponnaiyah Ramajayam Institute of
Science and Technology (PRIST)
Deemed to be University
Vaiiam, Thanjavur-613 403.



PRIST
DEPARTMENT OF MECHANICAL
ENGINEERING

ABOUT THE INSTITUTION

Ponnaiyah Ramajayam Institute of Science and Technology (PRIST) University (U/s 3 of the UGC Act 1956), is one of the renowned units of Ponnaiyah Ramajayam Institutions, which are serving for more than 25 years in promoting quality education and research for our Indian community, since its Inception. The institution is now brimming with many social responsibilities, particularly in promoting quality education through research.

ABOUT THE DEPARTMENT

The department of Mechanical Engineering came in to existence in 2008 with an objective to impart quality education to meet today's competitive environment.

Department has well experienced and dedicated faculty with strong commitment to provide a vibrant learning environment to the students in order to help them excel.

To keep pace with the current technological trends, the department has a well designed, constantly reviewed syllabus to incorporate all advancements in existing and emerging technologies which gives the students a holistic and pragmatic view of the present scenario of industry.

INFORMATION BROUCHER VALUE-ADDED COURSE - AUTOMATION IN AGRICULTURE

COURSE HIGHLIGHTS

- This course highlights the key uses of AI and ML techniques in farming and highlights the undeniably rising trend in the implementation of these techniques.
- This also highlights the use of machinery and equipment in agricultural operations to improve their diagnosis, decision-making or performing, reducing the drudgery of agricultural work and/or improving the timeliness, and potentially the precision, of agricultural operations.
- Automation technology helps in collecting information about conditions like weather, moisture, temperature and fertility of soil, Crop online monitoring enables detection of weed, level of water, pest detection, animal intrusion in to the field, crop growth, and agriculture.



COURSE OBJECTIVES

- To give the student the basic knowledge of about the field of production automation.
- To enable student to appreciate optimization of manufacturing systems Automation is a dynamic technology that represents a continuous evolutionary process in production.
- The main goal of automation is to improve efficiency, accuracy, and speed in business processes, ultimately leading to increased productivity and reduced costs.

PRE-REQUISITES

Understand and design basic mechanical concepts and reverse engineering.

ELIGIBILITY

B.Tech – Mechanical students shall be eligible for the admission to the course.

COURSE DURATION: 45 Hours

DATE: 10.06.2023 to 12.08.2023.

HOD

Department of Mechanical Engineering
Ponnaiyah Ramajayam Institute of
Science & Technology (PRIST)
(Institution Deemed to be University
/s. 3 of the UGC Act, 1956)

THANJAVUR - 613 403, TAMIL NADU, INDIA.

DEAN

School of Engineering and Tech.
Ponnaiyah Ramajayam Institute of
Science and Technology (PRIST)
Deemed to be University
Vallam, Thanjavur - 613 403.

AUTOMATION IN AGRICULTURE

OBJECTIVES

1. To know the operation of various electronic circuits and its applications.
2. To get adequate knowledge about various sensors and robots used in agricultural processes
3. To learn automation techniques in agricultural system

UNIT I INTRODUCTION

9

Fundamental of electronics Passive devices -semiconductor devices - transistors - diode circuits - amplifier circuits. Integrated circuits and operational amplifier - logic gates - flip flop - counters digital to analog - analog to digital converters- microprocessor.

UNIT II PRECISION FARMING

9

Precision farming -Ground based sensors, Remote sensing, GPS, GIS and mapping software, Yield mapping systems, Crop production modelling.

UNIT III ROBOTICS IN AGRICULTURE

9

Fundamental of Robotics - types – application. Agricultural robots - types- function - application. Future trends in automation in agriculture

UNIT IV AUTOMATION USING IoT

9

Use of different sensors - Temperature and humidity sensor - Soil Moisture Sensor - Water Level Depth Detector, Raspberry Pi Arduino UNO

UNIT V AUTOMATION OF AGRICULTURE OPERATION

9

Automation of agricultural operations using IoT based systems - Smart Irrigation System- Automation in Greenhouse – Drones. Case Study- Automation of greenhouse/farm operations.

TOTAL HOURS: 45

COURSE OUTCOMES

1. Exemplify the working operations of electronic devices and processors
2. Interpret the necessity of sensor requirements for precision farming practices
3. Understand the basics of robotics and their applications in agriculture
4. Apply the IOT concepts in cropping practices
5. Interpolate the concept of automation in governing the agricultural systems

REFERENCES

1. National Research Council, Precision Agriculture in the 21st Century, National Academies Press, Canada, 1997.
2. Young, S.L. and Pierce, F.J. eds., 2013. Automation: The future of weed control in cropping systems. Springer Science & Business Media.
3. Nof, S.Y. ed., 2009. Springer handbook of automation. Berlin, Heidelberg: Springer Berlin Heidelberg.
4. Billingsley, J., 2019. Robotics and automation for improving agriculture. Burleigh Dodds Science Publishing Limited.

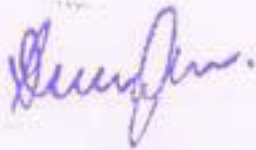

HOD

Department of Mechanical Engineering
Punnaiyah Ramajayam Institute of
Science & Technology (PRIST)
(Institution Deemed to be University
Section 3 of the UGC Act, 1956)
Thanjavur - 613 403, TAMIL NADU.



DEAN

School of Engineering and Tech.
Punnaiyah Ramajayam Institute of
Science and Technology (PRIST)
Deemed to be University
Vaiiam, Thanjavur-613 403



**PONNAIYAH RAMAJAYAM INSTITUTE OF
SCIENCE & TECHNOLOGY (PRIST)**

Declared as DEEMED-TO-BE-UNIVERSITY
U/s 3 of UGC Act, 1956

CIRCULAR

PRIST /MECH/CIRC/ 2023-2024/ ODD / VALUE-ADDED COURSES /03

DATE: 02.06.2023

It is informed that the ADD-ON COURSES will be conduct from 10.06.2023 to 12.08.2023.

I) CERTIFICATE COURSES

➤ PIPING TECHNOLOGY

Venue: C Block, Seminar Hall.

Timing: 10.00A.M to 4.00P.M

Duration: 45 hrs.

Students from mechanical department those who are interest can enroll their names and course to the HOD on or before 06/06/2023

**HOD
HOD**

Department of Mechanical Engineering
Ponnaiyah Ramajayam Institute of
Science & Technology (PRIST)
(Institution Deamed to be University
U/s 3 of the UGC Act 1956)
THANJAVUR - 613 403, Tamil Nadu.

**DEAN
DEAN**

School of Engineering and Tect.
Ponnaiyah Ramajayam Institute of
Science and Technology (PRIST)
Deamed to be University
Vailam, Thanjavur - 613,403.



PRIST
DEPARTMENT OF MECHANICAL ENGINEERING

ABOUT THE INSTITUTION

Ponnaiyah Ramajayam Institute of Science and Technology (PRIST) Deemed to be University (U/s 3 of the UGC Act 1956), is one of the renowned units of Ponnaiyah Ramajayam Institutions, which are serving for more than 25 years in promoting quality education and research for our Indian community, since its Inception. The institution is now brimming with many social responsibilities, particularly in promoting quality education through research.

ABOUT THE DEPARTMENT

The department of Mechanical Engineering came into existence in 2008 with an objective to impart quality education to meet today's competitive environment.

Department has well experienced and dedicated faculty with strong commitment to provide a vibrant learning environment to the students in order to help them excel.

To keep pace with the current technological trends, the department has a well designed, constantly reviewed syllabus to incorporate all advancements in existing and emerging technologies which gives the students a holistic and pragmatic view of the present scenario of industry.

INFORMATION BROUCHER VALUE-ADDED COURSE- PIPING TECHNOLOGY

COURSE HIGHLIGHTS

- Piping system designers that may decide to use expansion joints
- Expansion joint designers that use the information provided by piping system designers.
- To determine the best design to meet the requirements.
- Designers that use modern software systems to evaluate different options
- Engineers / Managers: field, maintenance, process, operations, construction, surveyors

About the Program

The objective of this course is to provide the candidates the Detail knowledge and skills in Piping Design discipline to facilitate faster learning curves while on the job.

This course will cover the fundamental principles and concepts used in Process Plant Layout and Piping Design Engineering. Upon completion of this course, students will have a clear understanding of the design and principles used in Piping Design System for Oil & Gas Energy Sector.

Learning-Based Outcomes

Get hands-on experience in applying design tools & techniques to real engineering problems and understand Design, Engineering, Construction, O & M, etc. Thus, become a Technology Driven Engineering Professional.

- 1 Be eligible for Design & Development Engineering domain & excel your career in the respective areas.
- 2 Explore + Analyse + Solve Engineering Problem using state-of-art Softwares & Tools.
- 3 Fill the void of thousands of untapped High-Paying Jobs in your core-domain with a great salary.
- 4 Helping in Ideation & Concept building to formulate ideas into reality.
- 5 Distinguish your professional profile from peer during interviews and stand out of the box.
- 6 Understand What & How aspect of Design Engineering
- 7 Perform the exercise by accessing our labs & simulation software.
- 8 Improve your Curriculum Vitae and your social job profile with Professional Projects & assignments.
- 9 Support your Start-up or your professional career with expert mentor guidance & support.
- 10 Develop the zeal of learning to embrace the knowledge into service & entrepreneurship domain.



PRE-REQUISITES

Understand and design basic mechanical concepts and reverse engineering .

ELIGIBILITY

B.Tech – Mechanical students shall be eligible for the admission to the course.

COURSE DURATION: 45 Hours

DATE : 10.06.2023 to 12.08.2023.

HOD

Department of Mechanical Engineering
Ponnaiyah Ramajayam Institute of
Science & Technology (PRIST)
Institution Deemed to be Univ.
U/s 3 of the UGC Act, 1956
CHANJAVUR - 613 403, Tamil Nadu, India.

DEAN

School of Engineering and Tech.
Ponnaiyah Ramajayam Institute of
Science and Technology (PRIST)
Deemed to be University
Chanjavar, Thanjavur - 613 403,
Tamil Nadu, India.

PIPING TECHNOLOGY

OBJECTIVE:

This class covers the following topics: piping design, the effects on overall configuration on preliminary piping design, initial layout, the total system, introduction to pipe stress analysis, detailed piping design, and how all of this influences pipe support and pipe hanger design.

Syllabus

Part 1: Introduction - Overview of Piping

1. This section serves as an introductory overview of piping system design.
 - a. Effects of operating conditions, including flow rate, design pressure and temperature on piping design
 - b. Impact of internal and external forces on the design.
 - c. Influences that the different modes of failure and the applicable codes have on the entire system.
 - d. Piping layout, an overview of the general support classifications.

Part 2: Preliminary Piping Design - Piping System Components

1. Concepts used in developing an initial piping layout.
2. Design principles including fluid properties, flow rate, and physical laws which influence the complete piping system layout.
3. Understand the effect of different piping system components, such as tanks, vessels, valves, and pumps, on the overall configuration.

Part 3: Preliminary Piping Design - The Total System

1. The total piping system.
2. The different types of equipment and components that define various types of piping systems.
3. Differences between series piping, parallel piping and branch piping as well as their specialized applications.
4. The piping system conditions such as static and dynamic head loss
5. Influences on the selection and distribution of piping components throughout the entire system.

Part 4: Basic Concepts of Stress Analysis - Flexibility Analysis

1. Historical perspective of how earlier analysis techniques were developed in the absence of today's computer technology.
2. Review how earlier techniques have evolved ultimately leading to today's finite element practices.
3. The basic concepts of stress analysis will be covered, including failure theories, stress intensification factors and the overall purpose of stress analysis.

Part 5: Basic Concepts of Stress Analysis - Design Bases

1. A review of the different phases of project evolution.
2. The design bases which form the foundation of all our analyses, including physical attributes,



HOD

Department of Mechanical Engineering
Ponnaiyah Ramajayam Institute of
Science & Technology (PRIST)
(Institution Deemed to be University
As 3 of the UGC Act 1956)
THANJAVUR - 613 403, TAMIL NADU.



DEAN

School of Engineering and Tech,
Ponnaiyah Ramajayam Institute of
Science and Technology (PRIST)
Deemed to be University
Vaniam, Thanjavur - 613 403.



**PONNAIYAH RAMAJAYAM INSTITUTE OF
SCIENCE & TECHNOLOGY (PRIST)**

Declared as DEEMED-TO-BE-UNIVERSITY
U/s 3 of UGC Act, 1956

CIRCULAR

PRIST /MECH/CIRC/ 2023-2024/ ODD / VALUE-ADDED COURSES /05

DATE: 07.02.2024

It is informed that the ADD-ON COURSES will be conduct from 17.02.2024 to 21.04.2024.

I) CERTIFICATE COURSES

➤ **GEOMETRIC DIMENSIONING AND TOLERANCE**

Venue: C Block, Seminar Hall.

Timing: 10.00A.M to 4.00P.M

Duration: 45 hrs.

Students from mechanical department those who are interest can enroll their names and course to the HOD on or before 12/02/2024

HOD

Department of Mechanical Engineering
Ponnaiyah Ramajayam Institute of
Science & Technology (PRIST)
(Institution Deemed to be University
U/s 3 of the UGC Act 1956)
THANJAVUR - 613 403, TAMIL NADU.

DEAN

School of Engineering and Tech.
Ponnaiyah Ramajayam Institute of
Science and Technology (PRIST)
Deemed to be University
Vaiiam, Thanjavur-613 403.



PRIST
DEPARTMENT OF MECHANICAL
ENGINEERING

ABOUT THE INSTITUTION

Ponnaiyah Ramajayam Institute of Science and Technology (PRIST) University (U/s 3 of the UGC Act 1956), is one of the renowned units of Ponnaiyah Ramajayam Institutions, which are serving for more than 25 years in promoting quality education and research for our Indian community, since its Inception. The institution is now brimming with many social responsibilities, particularly in promoting quality education through research.

ABOUT THE DEPARTMENT

The department of Mechanical Engineering came into existence in 2008 with an objective to impart quality education to meet today's competitive environment.

Department has well experienced and dedicated faculty with strong commitment to provide a vibrant learning environment to the students in order to help them excel.

To keep pace with the current technological trends, the department has a well designed, constantly reviewed syllabus to incorporate all advancements in existing and emerging technologies which gives the students a holistic and pragmatic view of the present scenario of industry.

**INFORMATION BROUCHER VALUE-ADDED
COURSE - GEOMETRIC DIMENSIONING AND
TOLERANCE**

COURSE HIGHLIGHTS

- This course highlights the purpose of GD&T is to describe the engineering intent of parts and assemblies. GD&T can more accurately define the dimensional requirements for a part, allowing over 50% more tolerance zone than coordinate (or linear) dimensioning in some cases.
- GD&T is the system that allows developers and inspectors to optimize functionality without increasing cost. The most important benefit of GD&T is that the system describes the design intent rather than the resulting geometry itself. Like a vector or formula, it is not the actual object but a representation of it.

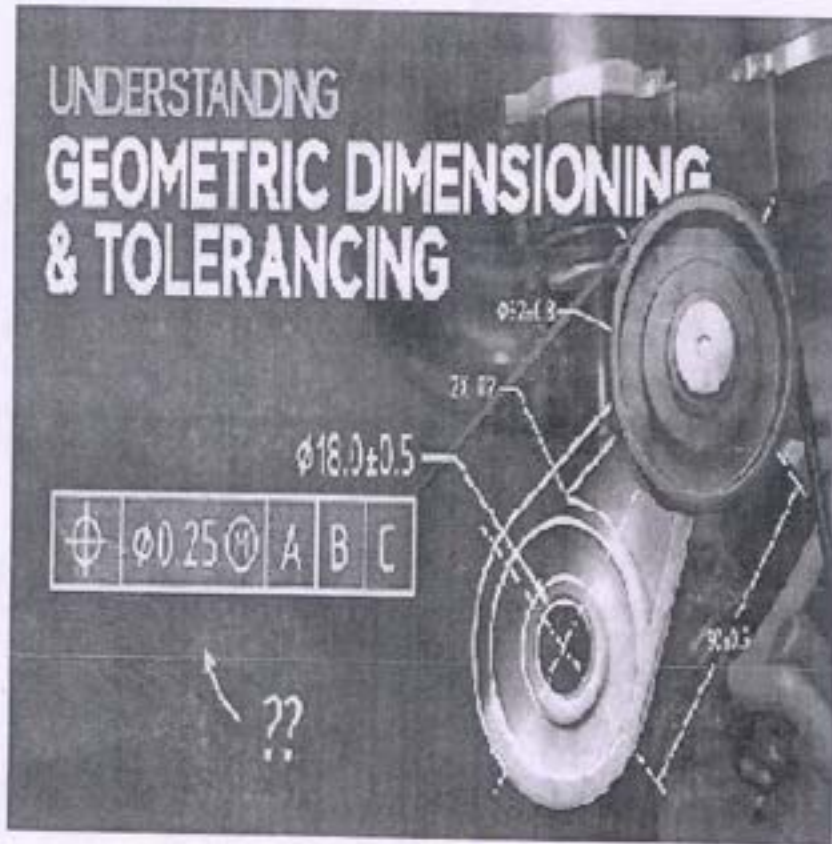

COURSE OBJECTIVES

- Visualize the different ways 3D parts are projected on 2D drawings and how to the different ways the full geometry of the part or assembly is presented.
- Determine how key information is organized in notes, symbols and title blocks.
- The GD&T Training Course provides a comprehensive introduction into how to apply, read and understand technical drawings employing Geometric Dimensioning & Tolerance. The main objective of training is to show users how the system can help them perform their jobs.

PRE-REQUISITES

Understand and design basic mechanical concepts and reverseengineering.

ELIGIBILITY

B.Tech – Mechanical students shall be eligible for the admission to thecourse.

COURSE DURATION: 45 Hours

DATE: 17.02.2024 to 21.04.2024.

HOD
 Department of Mechanical Engineering
 Ponnaiyah Ramajayam Institute of
 Science & Technology (PRIST)
 (Institution Deemed to be University
 re 3 of the UGC Act,1958)
 THANJAVUR - 613 403, TAMILNADU.

DEAN
 School of Engineering and Tech.
 Ponnaiyah Ramajayam Institute of
 Science and Technology (PRIST)
 Deemed to be University
 Varam, Thanjavur - 613 403.

GEOMETRIC DIMENSIONING AND TOLERANCING

OBJECTIVES

To apply the concepts of GD&T for design, manufacturing and inspection.

UNIT - I INTRODUCTION

9

Geometric product definition principles; verification of position with open setup; geometric characteristic symbols Geometric Dimensioning and Tolerancing: an explanation of tolerance zone conversion; surfaces, features, features of size, datum features, datum features of size, and datum's; tolerances; components common to geometrically dimensioned & toleranced drawing; fits & allowances, advantages of GD&T.

UNIT - II MMC, LMC & RFS

9

Maximum Material Condition (meaning & use); Least Material Condition (meaning & use); Regardless of Feature Size How to read a Feature Control Frame.

UNIT - III SIZE CONTROL FORM

9

The Taylors principle; Gauging size limits. Rules, concepts, Characteristics, and Untoleranced Dimensions: individual or related Datum's, Material Conditions; untoleranced dimensions.

UNIT - IV DATUMS

9

Datum features; oddly configured & curved surfaces as datum features; equalizing datum's; datum feature symbols; flexible parts; direct vs indirect tolerancing. MMC and its ramifications. Relations between individual features. Virtual Condition and Resultant condition Boundaries: Virtual condition (MMC concept & a functional boundary). Effect of LMC; wall thickness calculation.

UNIT - V LOGICAL APPROACH

9

A Logical Approach to part Tolerancing Dimensioning and Tolerancing Schemes Steps for the Development of a Dimensional Inspection Plan Paper Gauging and Functional Gauging.

TOTAL HOURS: 45

COURSE OUTCOMES

1. Contrast between conventional and GD&T tolerance zones
2. Explain MMC, LMC and RFS concepts
3. Explain Taylor's principle of gauging
4. Assess the significance of selection of datum & datum features
5. Explain the use of paper and functional gauging

REFERENCES

1. James D Meadows, "Geometric Dimensioning and Tolerancing", Marcel Dekker, Inc
2. James D Meadows, "Measurement of Geometric Tolerances in Manufacturing" Marcel Dekker, Inc
3. P S Gill, "Geometric Dimensioning and Tolerancing", S K Kataria & sons, 2005-6



HOD

Department of Mechanical Engineering
Ponnaiyah Ramajayam Institute of
Science & Technology (PRIST)
(Institution Deemed to be University,
Uo 3 of the UGC Act, 1956)
VAILAM, THANJAVUR - 613 403, TAMIL



DEAN

School of Engineering and Tech.
Ponnaiyah Ramajayam Institute of
Science and Technology (PRIST)
Deemed to be University
Vailam, Thanjavur - 613 403.



**PONNAIYAH RAMAJAYAM INSTITUTE OF
SCIENCE & TECHNOLOGY (PRIST)**

Declared as DEEMED-TO-BE-UNIVERSITY
U/s 3 of UGC Act, 1956

CIRCULAR

PRIST /MECH/CIRC/ 2023-2024/ ODD / VALUE-ADDED COURSES /02

DATE: 02.06.2023

It is informed that the ADD-ON COURSES will be conduct from 19.08.2023 to 21.10.2023.

I) CERTIFICATE COURSES

➤ QUALITY ASSURANCE, SIX SIGMA AND LEAN MANUFACTURING

Venue: C Block, Seminar Hall.

Timing: 10.00A.M to 4.00P.M

Duration: 45 hrs.

Students from mechanical department those who are interest can enroll their names and course to the HOD on or before 16/08/2023

HOD

HOD

**Department of Mechanical Engineering
Ponnaiyah Ramajayam Institute of
Science & Technology (PRIST)
(Institution Deemed to be University
U/s 3 of the UGC Act 1956)
THANJAVUR - 613 403, TAMIL NADU.**

DEAN

DEAN

**School of Engineering and Tech.
Ponnaiyah Ramajayam Institute of
Science and Technology (PRIST)
Deemed to be University
Vandavasi, Thanjavur-613 403.**



PRIST

DEPARTMENT OF MECHANICAL ENGINEERING

ABOUT THE INSTITUTION

Ponnaiyah Ramajayam Institute of Science and Technology (PRIST) University (U/s 3 of the UGC Act 1956), is one of the renowned units of Ponnaiyah Ramajayam Institutions, which are serving for more than 25 years in promoting quality education and research for our Indian community, since its Inception. The institution is now brimming with many social responsibilities, particularly in promoting quality education through research.

ABOUT THE DEPARTMENT

The department of Mechanical Engineering came into existence in 2008 with an objective to impart quality education to meet today's competitive environment.

Department has well experienced and dedicated faculty with strong commitment to provide a vibrant learning environment to the students in order to help them excel.

To keep pace with the current technological trends, the department has a well designed, constantly reviewed syllabus to incorporate all advancements in existing and emerging technologies which gives the students a holistic and pragmatic view of the present scenario of industry.

INFORMATION BROUCHER VALUE - ADDED COURSE - QUALITY ASSURANCE, SIX SIGMA AND LEAN MANUFACTURING.

COURSE HIGHLIGHTS

- Training content are based on latest Six Sigma
- Earn 16 Hours PDU (Training) Certificate
- Training & Exam Fee Course ware Mock Tests and more.
- Best Certified Instructors with decades of experience in subject matter.
- Complimentary 180 Days of High Quality E-Learning Access
- Premium Access to Six Sigma resources and Six Sigma Job Portal.



COURSE OBJECTIVES

- Skill to predict, prevent and control defects in a process.
- Understanding the elements of waste.
- Skills to achieve sustainable quality improvement through process improvement.
- Understanding of variation in processes.
- Skills to reduce variation in processes and achieve predicted outcomes.
- Ability to identify, measure and analyse process potential.
- Usage of inferential statistics.
- Usage of hypothesis testing.

PRE-REQUISITES

Understand and design basic mechanical concepts and reverseengineering .

ELIGIBILITY

B.Tech – Mechanical students shall be eligible for the admission to thecourse.

COURSE DURATION: 45 Hours

DATE : 19.08.2023 to 21.10.2023

[Handwritten Signature]
HOD

Department of Mechanical Engineering
Jannaiyah Ramajayam Institute of
Science & Technology (PRIST)
Institution Deemed to be University
(As per the UGC Act 1956)
NJAVUR - 613 403, TAMIL NADU.

[Handwritten Signature]
HEAD

School of Engineering and Tech,
Jannaiyah Ramajayam Institute of
Science and Technology (PRIST)
Deemed to be University
Vudalur, Thanjavur-613 403.

QUALITY ASSURANCE , SIX SIGMA AND LEAN MANUFACTURING

OBJECTIVES:

- To impart knowledge to enable the students to design and implement Statistical Process Control in any industry

UNIT I QUALITY FUNDAMENTALS

9

Importance of quality- evolution of quality- definitions of quality- dimensions of quality- quality control- quality assurance- areas of quality- quality planning- quality objectives and policies- quality costs- economics of quality- quality loss function- quality Vs productivity- Quality Vs reliability.

UNIT II SIX SIGMA METHODOLOGY- TOOLS & TECHNIQUES

9

Cost of Quality – Conformance and Non-Conformance cost – 7 Basic Quality Control Tools – Seven Management tools – FMEA

Need for Six Sigma – Six Sigma Team – DMAIC Methodology: Define, Measure, Analyse, Improve and Control – Lean Six Sigma

UNIT III EVOLUTION & OVERVIEW OF LEAN MANUFACTURING

9

Evolution of Mass production – Traditional vs. Mass production – Evolution of Toyota (Lean) Production System – Business Dynamics of Lean production – Principles of Lean production: Value, Value stream, Flow, Pull, Perfection.

UNIT IV LEAN MANUFACTURING – TOOLS & TECHNIQUES

9

Ms: Muda, Mura, Muri – 7 Wastes in Manufacturing – Lean Tools to eliminate Muda – 5S – Standardised work – TPM – SMED – Jidoka – Poka Yoke – JIT – Heijunka – Kanban – One piece production.

UNIT V VALUE STREAM MAPPING

9

Need for Value Stream mapping – Steps involved in Value stream mapping – Choose value stream – PQ and PR analysis – Current State map – Lean Metrics – Future State Map – Kaizen plans – Lean implementation – Cultural change – Lean in the Supply chain.

TOTAL: 45 PERIODS

OUTCOMES:

- Control the quality of processes using control charts for variables in manufacturing industries.
- The students should apply the various tools, techniques and methodology of lean manufacturing.
- six sigma concepts to the potential quality gaps in manufacturing / production industries.
- Able to learn concept of tool and technique.
- Lean the Supply chain concept.

REFERENCES:

1. Pascal Dennis, "Lean Production Simplified: A plain Language Guide to the World's Most Powerful Production System", Productivity Press, 2007.
2. Issa Bass and Barbara Lawton, "Lean Six Sigma using Sigma XL and Minitab", Tata McGraw Hill, 2010.
3. Yasuhiro Monden, "Toyota Production System: An Integrated Approach to Just-in-Time", CRC Press, 2012.

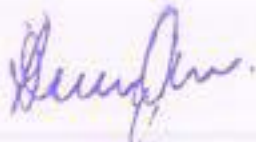

HOD

Department of Mechanical Engineering
Ponnaiyah Ramajayam Institute of
Science & Technology (PRIST)
(Institution Deemed to be Unre-
g. 3 of the UGC Act, 1956)
THANJAVUR - 613 403, TAMIL NADU.



DEAN

School of Engineering and Tech,
Ponnaiyah Ramajayam Institute of
Science and Technology (PRIST)
Deemed to be University
Vaiiam, Thanjavur-613 403.



**PONNAIYAH RAMAJAYAM INSTITUTE OF
SCIENCE & TECHNOLOGY (PRIST)**

Declared as DEEMED-TO-BE-UNIVERSITY
U/s 3 of UGC Act, 1956

CIRCULAR

PRIST /MECH/CIRC/ 2023-2024/ ODD / VALUE-ADDED COURSES /04

DATE: 04.12.2023

It is informed that the ADD-ON COURSES will be conduct from 09.12.2023 to 10.02.2024.

I) CERTIFICATE COURSES

➤ **MARINE CONSTRUCTION AND WELDING**

Venue: C Block, Seminar Hall.

Timing: 10.00A.M to 4.00P.M

Duration: 45 hrs.

Students from mechanical department those who are interest can enroll their names and course to the
HOD on or before 06/12/2023

**HOD
HOD**

Department of Mechanical Engineering
Ponnaiyah Ramajayam Institute of
Science & Technology (PRIST)
(Institution Deemed to be University
U/s 3 of the UGC Act, 1956)
Valurambadi - 613 403, TAMIL NADU.

DEAN

Dean
School of Engineering and Tech.
Ponnaiyah Ramajayam Institute of
Science and Technology (PRIST)
Deemed to be University
Valurambadi, Thanjavur - 613 403.



PRIST
DEEMED TO BE
UNIVERSITY
NAAC ACCREDITED
THANJAVUR - 613 403 - TAMIL NADU

DEPARTMENT OF MECHANICAL ENGINEERING

ABOUT THE INSTITUTION

Ponnaiyah Ramajayam Institute of Science and Technology (PRIST) Deemed to be University (U/s 3 of the UGC Act 1956), is one of the renowned units of Ponnaiyah Ramajayam Institutions, which are serving for more than 25 years in promoting quality education and research for our Indian community, since its Inception. The institution is now brimming with many social responsibilities, particularly in promoting quality education through research.

ABOUT THE DEPARTMENT

The department of Mechanical Engineering came into existence in 2008 with an objective to impart quality education to meet today's competitive environment.

Department has well experienced and dedicated faculty with strong commitment to provide a vibrant learning environment to the students in order to help them excel.

To keep pace with the current technological trends, the department has a well designed, constantly reviewed syllabus to incorporate all advancements in existing and emerging technologies which gives the students a holistic and pragmatic view of the present scenario of industry.

INFORMATION BROUCHER VALUE ADDED COURSE- MARINE CONSTRUCTION AND WELDING

COURSE OBJECTIVES

- General and Industry Specific Safety (Welding and Allied Equipment)
- Oxy Fuel, Arc and Inert Gas Theory
- Blueprint Reading, Weld Symbols and Applied Math
- Use of Hand Tools
- Use of Powered Fabrication Equipment • Oxy Fuel Cutting and Gouging
- Plasma Arc Cutting
- Shielded Metal Arc Welding
- Gas Metal Arc Welding
- Gas Tungsten Arc Welding
- Flux Core Arc Welding • 3G and 4G D1.1 Structural Weld Test, SMAW and FCAW 1"

COURSE OVERVIEW

This program is designed to develop the skills necessary for performing work in the field of welding and fabrication. Instruction will begin with a strong emphasis on safety and will address the many precautions that need to be taken to insure the safe operations of welding and fabrication equipment, as well as general industrial safety.

The tools, applied math, layout, print reading, and measuring are explained as well as hands on fabrication. Processes covered are sawing, shearing, and punching of structural steel. Next, instruction will be provided in SMAW (Shielded Metal Arc Welding), GMAW (Gas Metal Arc Welding), FCAW (Flux Cored Arc Welding), GTAW (Gas Tungsten Arc Welding) and thermal cutting techniques.

Eligible students may elect to test under AWS QC 10 certification guidelines in the 3G and 4G positions pertaining to the AWS D1.1 Structural Code. Also covered will be Oxy Acetylene Cutting and Welding, Plasma Arc Cutting and Carbon Arc Cutting.

This training serves as a progressive introduction to the technical skills and practices to prepare students for employment as flame cutters, structural welders, tack welders, welder assemblers, welder helpers, arc cutters and production line welders.

HOD

Department of Mechanical Engineering
Ponnaiyah Ramajayam Institute of
Science & Technology (PRIST)

(Institution Deemed to be University)

Act 3 of the UGC Act 1956

THANJAVUR - 613 403, TAMIL NADU

COURSE OUTCOMES

- ✓ The student will obtain entry level skills and understanding of virtually all the welding and cutting processes used in production and repair today. The student will have the theory, fundamentals of operation, equipment used and techniques recommended for all of the welding, cutting and fabrication processes that are commercially used.



PRE-REQUISITES

Understand and design basic mechanical concepts and reverse engineering.

ELIGIBILITY

B.Tech – Mechanical students shall be eligible for the admission to the course.

COURSE DURATION: 45 Hours

TIMING: 10.00 am - 4.00 pm

DATE: 09.12.2023 to 10.02.2024.

Deemed to be University
Vallam, Thanjavur - 613 403

MARINE CONSTRUCTION AND WELDING

Objectives:

- Understand about different types of welding processes and equipments.
- Know about the special welding process.
- Study about metallurgy of welding.
- Acquire broader ideas about weldability of ferrous and non ferrous metals.
- Understand about welding economy and applications.

UNIT I METAL JOINING PROCESSES

Classification plastic welding, fusion welding, solid phase welding and sub classification. Study of power sources, electrodes, welding symbols - processes and applications: SMAW, GTAW, GMAW, electro gas welding and Electro Slag, resistance welding. Gas welding, oxy acetylene cutting, brazing and soldering.

UNIT II CASTING PROCESSES

Sand casting, pattern and core making, moulding process - sand properties, Gate cutting and allowances-melting furnaces – pit furnace and electric furnaces. Special casting processes – shell, investment, die casting – pressure and gravity types – squeeze casting - defects in casting

UNIT III FINISHING PROCESSES

Surface finishing processes: grinding processes, various types of grinders, work holding devices, grinding wheels and specification, selection of grinding wheels for specific applications – selection of cutting speed and work speed. Fine Finishing Process: Lapping, honing, and super finishing process, ship hull finishing.

UNIT IV METAL FORMING PROCESSES

Hot and cold working processes – rolling, forging, drawing and extrusion processes, bending, hot spinning, shearing, tube and wire drawing, cold forming, shot peening. Sheet metal working

UNIT V MACHINING PROCESSES

Drilling - classification, specification, cutters speed feed and description of parts parts-boring machines- classification, principle, parts- specification. Milling - classification, principle, parts- specification-operations. Shaper and Planer- Principle -parts -operations - CNC Machines

TOTAL : 45 PERIODS

OUTCOMES:

The students will be able

- To know the different welding process and select the appropriate process for different applications
- To have the knowledge of different casting process and select the appropriate process for different applications.

- To select the Grinding Wheel and process based on the surface finish required.
- To have the depth understanding of various hot working and cold working process.
- To select the appropriate machines or machines tools for different requirements .



HOD

Department of Mechanical Engineering
Ponnalyah Ramajayam Institute of
Science & Technology (PRIST)
(Institution Deemed to be Un-
/s 3 of the UGC Act, 1956)
THANJAVUR - 613 403, TAMIL NADU.



School of Engineering and Tech,
Ponnalyah Ramajayam Institute of
Science and Technology (PRIST),
Deemed to be University
Vallam, Thanjavur-613 #03.



SCHOOL OF ENGINEERING AND TECHNOLOGY
DEPARTMENT OF MECHANICAL ENGINEERING
ACADEMIC YEAR 2023-2024
ADD ON COURSE ON PIPING TECHNOLOGY

S. NO	NAME	REG NO	YEAR/BRANCH
1	ABIMANYU S	2001ME10101	IV/MECH
2	B.AKASH	2001ME10102	IV/MECH
3	MOHAMED BAZEER J	2001ME10103	IV/MECH
4	SHEIK ABDULLA A	2101ME13102	IV/MECH
5	N. EJAAS	2101ME13103	IV/MECH
6	A.BHARATHIDHASAN	2101ME13105	IV/MECH
7	R.KARTHIK RAJA	2101ME13106	IV/MECH
8	J.PRAVEEN	2101ME13107	IV/MECH
9	V.YASHWANTH	2101ME13112	IV/MECH
10	VIGNESH. M	2101ME13113	IV/MECH
11	V.VIGNESH	2101ME13114	IV/MECH
12	PADMANABHAN.M	2101ME13115	IV/MECH
13	GANESAN.N	2101ME13116	IV/MECH
14	SURYA S	2101ME13117	IV/MECH
15	M.FAHIM AKTHAR	2101ME13118	IV/MECH
16	S.VIJAYARAJAGOPAL	2101ME13119	IV/MECH
17	A.ARIVUDURAI	2101ME13120	IV/MECH
18	MOHAMMED FAIZAL. M	2101ME13125	IV/MECH
19	DHIVAKAR.V	2101ME13126	IV/MECH
20	A. VIGNESH	2101ME13127	IV/MECH
21	N.VINEETH	2101ME13128	IV/MECH
22	SARAVANAN.J	2101ME13129	IV/MECH
23	M. NAVEEN	2101ME13131	IV/MECH
24	J.KIRIDAREN	2101ME13134	IV/MECH
25	M.S.MOHAMAD AKRAM	2101ME13135	IV/MECH
26	SUDHARSAN.G	2101ME13136	IV/MECH
27	K. VASANTH	2101ME13137	IV/MECH
28	E.SANJAI	2101ME13142	IV/MECH
29	S.SULAIMAN SATE	2101ME13143	IV/MECH
30	AKIL.AHAMED.M	2101ME13144	IV/MECH
31	MANIKANDAN.M	2101ME13145	IV/MECH
32	VUJAY.NAVEEN.J	2101ME13146	IV/MECH
33	DEVADHARSHAN.K	2101ME13147	IV/MECH
34	VIGNESHWARAN.P	2101ME13148	IV/MECH
35	SATHEESH.S	2101ME13152	IV/MECH
36	AKASH.V	2101ME13153	IV/MECH
37	KATHIRESAN.D	2101ME13154	IV/MECH
38	TAMILINIYAN.S	2101ME13155	IV/MECH
39	MUKESH.B	2101ME13156	IV/MECH
40	VENGADESAN.N	2101ME13157	IV/MECH
41	MOHAMED JUBAIR.K	2101ME13158	IV/MECH
42	AKASH.D	2101ME13159	IV/MECH



PONNAIYAH RAMAJAYAM INSTITUTE OF
SCIENCE & TECHNOLOGY (PRIST)

Deemed as Deemed-to-Be-University
Uis 5 of UGC Act, 1956

SCHOOL OF ENGINEERING AND TECHNOLOGY
DEPARTMENT OF MECHANICAL ENGINEERING
ACADEMIC YEAR 2023-2024
ADD ON COURSE ON PIPING TECHNOLOGY

S. NO	NAME	REG NO	10.06.23	24.06.23	01.07.23	08.07.23	15.07.23	22.07.23	29.07.23	05.08.23	12.08.23
1	ABIMANYU S	2001ME10101	/	/	/	/	/	/	/	/	/
2	B.AKASH	2001ME10102	/	/	/	/	/	/	/	/	/
3	MOHAMED BAZEER J	2001ME10103	/	/	/	/	/	/	/	/	/
4	SHEIK ABDULL.A.A	2101ME13102	/	/	/	/	/	/	/	/	/
5	N. EJAAS	2101ME13103	/	/	/	/	/	/	/	/	/
6	A.BHARATHIDHASAN	2101ME13105	/	/	/	/	/	/	/	/	/
7	R.KARTHIK RAJA	2101ME13106	/	/	/	/	/	/	/	/	/
8	J.PRAVEEN	2101ME13107	/	/	/	/	/	/	/	/	/
9	V.YASHWANTH	2101ME13112	/	/	/	/	/	/	/	/	/
10	VIGNESH. M	2101ME13113	/	/	/	/	/	/	/	/	/
11	V.VIGNESH	2101ME13114	/	/	/	/	/	/	/	/	/
12	PADMANABHAN.M	2101ME13115	/	/	/	/	/	/	/	/	/
13	GANESAN.N	2101ME13116	/	/	/	/	/	/	/	/	/
14	SURYA S	2101ME13117	/	/	/	/	/	/	/	/	/
15	M.FAHIM AKTHAR	2101ME13118	/	/	/	/	/	/	/	/	/
16	S VIJAYARAJAGOPAL	2101ME13119	/	/	/	/	/	/	/	/	/
17	A.ARVUDURAJ	2101ME13120	/	/	/	/	/	/	/	/	/
18	MOHAMMED FAIZAL. M	2101ME13125	/	/	/	/	/	/	/	/	/
19	DHIVAKAR. V	2101ME13126	/	/	/	/	/	/	/	/	/



SCHOOL OF ENGINEERING AND TECHNOLOGY
DEPARTMENT OF MECHANICAL ENGINEERING
ACADEMIC YEAR 2023-2024

ADD ON COURSE ON GEOMETRIC DIMENSIONING AND TOLERANCE

S. NO	NAME	REG NO	YEAR/BRANCH
1	A.AJMAL HUSSAIN	2101ME13109	IV/MECH
2	K.HARI HARAN	2101ME13110	IV/MECH
3	E DIVIJ SHANOON	2101ME13111	IV/MECH
4	R SUBASH CHANDAR	2101ME13121	IV/MECH
5	K.A.BALAMURUGAN	2101ME13122	IV/MECH
6	VETRIVEL D	2101ME13123	IV/MECH
7	S.M.ADHITHYAN	2101ME13124	IV/MECH
8	M.MABROOK RAHMAN	2101ME13132	IV/MECH
9	M.VIGNESH	2101ME13133	IV/MECH
10	G.ARAVINDHAN	2101ME13138	IV/MECH
11	SUBASH V	2101ME13140	IV/MECH
12	VELMURUGAN R	2101ME13141	IV/MECH
13	BALA VIGNESHWARAN M	2101ME13149	IV/MECH
14	ARUN PRAKASH M	2101ME13150	IV/MECH
15	KATHIRAVAN K	2101ME13151	IV/MECH
16	MANIKANDAN	2101ME10101	IV/MECH
17	TAMILVENTHAN	2101ME10102	IV/MECH
18	NAGA ARJUN K	2201ME10103	II/MECH
19	NITHISH KUMAR K	2201ME10104	II/MECH
20	MANICKAVASAKAM T	2201ME10110	II/MECH
21	LOGESH V	2201ME10111	II/MECH
22	GOPIGAN D	2201ME10121	II/MECH
23	GOTHANDARAMAN K	2201ME10122	II/MECH
24	IMTHIYAZ M	2201ME10123	II/MECH
25	JAYAPRAKASH R	2201ME10124	II/MECH
26	MANIVANNAN B	2201ME10129	II/MECH
27	MAVEERAN B	2201ME10130	II/MECH
28	SARAVANA KUMAR M	2201ME10150	II/MECH
29	SARAVANAN M	2201ME10151	II/MECH
30	SATHIYASEELAN R	2201ME10152	II/MECH
31	SELVAGANABATHI B	2201ME10153	II/MECH
32	SENTHAMILSELVAN M	2201ME10154	II/MECH
33	SILAMBARASAN A	2201ME10155	II/MECH
34	SIVARAMAN R	2201ME10156	II/MECH
35	SOLOMON M	2201ME10157	II/MECH
36	ASRATH SATHICK A	2201ME13108	III/MECH
37	SANTHOSH S	2201ME13109	III/MECH
38	PARTHIBAN R	2201ME13110	III/MECH
39	LOKESH M	2201ME13118	III/MECH
40	MAHADEVAN D	2201ME13119	III/MECH
41	MOHAMED RAHITH J	2201ME13120	III/MECH
42	MOHAMED RIYASUDEEN M	2201ME13121	III/MECH
43	NITHISHKUMAR S	2201ME13122	III/MECH
44	RAJESH D	2201ME13123	III/MECH
45	SARAVANA KUMAR S	2201ME13124	III/MECH



SCHOOL OF ENGINEERING AND TECHNOLOGY
DEPARTMENT OF MECHANICAL ENGINEERING
ACADEMIC YEAR 2023-2024

ADD ON COURSE ON GEOMETRIC DIMENSIONING AND TOLERANCE

S. NO	NAME	REG NO	17.02.24	24.02.24	03.03.24	10.03.24	17.03.24	24.03.24	07.04.24	14.04.24	21.04.24
1	A.AJMAL HUSSAIN	2101ME13109	/	/	/	/	/	/	/	/	/
2	K.HARIHARAN	2101ME13110	/	/	/	/	/	/	/	/	AB
3	E.DIVIJ SHANON	2101ME13111	/	/	/	/	/	/	/	/	/
4	R.SUBASH CHANDAR	2101ME13121	/	/	/	/	/	/	/	/	/
5	K.A.BALAMURUGAN	2101ME13122	/	/	/	/	/	/	/	/	/
6	VETRIVEL D	2101ME13123	/	/	/	/	/	/	/	/	/
7	S.M.ADHITHYAN	2101ME13124	AB	/	/	/	/	/	/	/	/
8	M.MABROOK RAHMAN	2101ME13132	/	/	/	/	/	/	/	/	/
9	M.VIGNESH	2101ME13133	/	/	/	/	AB	/	/	/	/
10	G.ARAVINDHAN	2101ME13138	/	/	/	/	/	/	/	/	/
11	SUBASH V	2101ME13140	/	/	/	/	/	/	/	/	/
12	VELMURUGAN.R	2101ME13141	/	/	/	/	/	/	/	/	/
13	BALA VIGNESHWARAN .M	2101ME13149	/	/	/	/	/	/	/	/	/
14	ARUN PRAKASH .M	2101ME13150	/	/	/	/	/	/	AB	/	/
15	KATHIRAVAN .K	2101ME13151	/	/	/	/	/	/	/	/	/
16	MANIKANDAN	2101ME10101	/	/	/	/	/	/	/	/	/
17	TAMILVENTHAN	2101ME10102	/	/	/	/	/	/	/	/	/
18	NAGA ARJUN K	2201ME10103	/	/	/	/	/	/	/	/	/
19	NITHISH KUMAR K	2201ME10104	/	/	/	/	/	/	/	/	/
20	MANICKAVASAKAM T	2201ME10110	/	/	/	/	/	/	/	/	/



SCHOOL OF ENGINEERING AND TECHNOLOGY
DEPARTMENT OF MECHANICAL ENGINEERING
ACADEMIC YEAR 2023-2024
ADD ON COURSE ON AUTOMATION IN AGRICULTURE

S. NO	NAME	REG NO	YEAR/BRANCH
1	DIVYA PRAKASH J	2201ME10101	II/MECH
2	HARIRAJ. V	2201ME10102	II/MECH
3	RAJINI E	2201ME10105	II/MECH
4	MURUGANANTHAM V	2201ME10106	II/MECH
5	MANIKANDAN T	2201ME10107	II/MECH
6	KIRUVANKUMAR B	2201ME10108	II/MECH
7	THANUSU M	2201ME10109	II/MECH
8	VENKATESH G	2201ME10112	II/MECH
9	ABDULRAHMAN.S	2201ME10113	II/MECH
10	AJITH.K	2201ME10114	II/MECH
11	AJITH KUMAR.M	2201ME10115	II/MECH
12	ARIVAZHAGAN.P	2201ME10116	II/MECH
13	DEVAKUMAR.L	2201ME10117	II/MECH
14	DINESH.B	2201ME10118	II/MECH
15	ELAMARAN.M	2201ME10119	II/MECH
16	GANDHIS	2201ME10120	II/MECH
17	KALAIYARASAN.C	2201ME10125	II/MECH
18	KARTHIS	2201ME10126	II/MECH
19	KARTHIKEYAN.M	2201ME10127	II/MECH
20	KARTHIKEYAN.S	2201ME10128	II/MECH
21	MOHAMED ISMAIL.S	2201ME10131	II/MECH
22	MOHAMED SOFIYAN.RH	2201ME10132	II/MECH
23	MOOVENDAR.P	2201ME10133	II/MECH
24	MUHILAN.G	2201ME10134	II/MECH
25	MUKILAN.S	2201ME10135	II/MECH
26	NAVEEN.T	2201ME10136	II/MECH
27	NEELAKANDAN.A	2201ME10137	II/MECH
28	PRABHAKARAN.M I/4/1993	2201ME10138	II/MECH
29	PRADEEP.P	2201ME10140	II/MECH
30	PRADEEP.R	2201ME10141	II/MECH
31	PRASANTH.M	2201ME10142	II/MECH
32	PRITHIVIRAJ.B	2201ME10143	II/MECH
33	RAJESH.R	2201ME10144	II/MECH
34	RANJITH.R	2201ME10145	II/MECH
35	REVANTH.C	2201ME10146	II/MECH
36	SABAREESWARAN.N	2201ME10147	II/MECH
37	SAMINATHAN.R	2201ME10148	II/MECH
38	SANTHOSH.R	2201ME10149	II/MECH
39	SAMINATHAN.R	2201ME10148	II/MECH
40	SANTHOSH.R	2201ME10149	II/MECH



PONNAIYAH RAMAJAYAM INSTITUTE OF
SCIENCE & TECHNOLOGY (PRIST)

Declared as DECEMED TO BE UNIVERSITY
Utk 3 of UDC Act, 1956

SCHOOL OF ENGINEERING AND TECHNOLOGY
DEPARTMENT OF MECHANICAL ENGINEERING
ACADEMIC YEAR 2023-2024
ADD ON COURSE ON AUTOMATION IN AGRICULTURE

S. NO	NAME	REG NO	10.06.23	24.06.23	01.07.23	08.07.23	15.07.23	22.07.23	29.07.23	05.08.23	12.08.23
1	DIVYA PRAKASH J	2201ME10101	/	/	/	/	/	/	/	/	/
2	HARIRAJ. V	2201ME10102	/	/	/	/	/	/	/	/	/
3	RAJINI E	2201ME10105	/	/	/	/	/	/	/	/	/
4	MURUGANANTHAM V	2201ME10106	/	/	/	/	/	/	/	/	/
5	MANIKANDAN T	2201ME10107	/	/	/	/	/	/	/	/	/
6	KIRUVANKUMAR B	2201ME10108	/	/	/	/	/	/	/	/	/
7	THANUSU M	2201ME10109	/	/	/	/	/	/	/	/	/
8	VENKATESH G	2201ME10112	/	/	/	/	/	/	/	/	/
9	ABDULRAHMAN.S	2201ME10113	/	/	/	/	/	/	/	/	/
10	AJITH.K	2201ME10114	/	/	/	/	/	/	/	/	/
11	AJITH KUMAR.M	2201ME10115	/	/	/	/	/	/	/	/	/
12	ARIVAZHAGAN.P	2201ME10116	/	/	/	/	/	/	/	/	/
13	DEVAKUMAR.L	2201ME10117	/	/	/	/	/	/	/	/	/
14	DINESH.B	2201ME10118	/	/	/	/	/	/	/	/	/
15	ELAMARAN.M	2201ME10119	/	/	/	/	/	/	/	/	/
16	GANDHI.S	2201ME10120	/	/	/	/	/	/	/	/	/
17	KALAIYARASAN.C	2201ME10125	/	/	/	/	/	/	/	/	/



PONNAIYAH RAMAJAYAM INSTITUTE OF
SCIENCE & TECHNOLOGY (PRIST)

Declared as DEEMED TO BE UNIVERSITY
Via U of OGC Act, 1988

SCHOOL OF ENGINEERING AND TECHNOLOGY
DEPARTMENT OF MECHANICAL ENGINEERING
ACADEMIC YEAR 2023-2024
ADD ON COURSE ON MARINE CONSTRUCTION AND WELDING

S. NO	NAME	REG NO	YEAR/BRANCH
1	MANIKANDAN	2101ME10101	III/MECH
2	TAMILVENTHAN	2101ME10102	III/MECH
3	VINOTHRAJ M	2201ME13101	III/MECH
4	HARISHWARAN V	2201ME13102	III/MECH
5	CHANAKIYAN T	2201ME13103	III/MECH
6	SANTHOSH RAMAN K R	2201ME13104	III/MECH
7	ADITHYAN B	2201ME13106	III/MECH
8	MOOVENDAR P	2201ME13111	III/MECH
9	AJITH KUMAR S	2201ME13112	III/MECH
10	AKASH P	2201ME13113	III/MECH
11	ATCHAYA KUMAR P	2201ME13114	III/MECH
12	DEEPAN J	2201ME13115	III/MECH
13	GANESH VASANTHAKUMAR E	2201ME13116	III/MECH
14	GOPINATHAN S	2201ME13117	III/MECH
15	VENGATESH R	2201ME13125	III/MECH
16	JASVANTH S	2201ME13126	III/MECH
17	SUDHAHARAN H	2201ME13127	III/MECH
18	SURIYA PRAKASH S	2201ME13128	III/MECH
19	KEERTHIVASAN R	2201ME13129	III/MECH
20	AJITHKUMAR C	2201ME13130	III/MECH
21	ABINESH R	2201ME13131	III/MECH
22	AKASH M	2201ME13132	III/MECH
23	GNANA CELSHIYA J	2201ME13133	III/MECH
24	KARTHIK RAJA R	2201ME13134	III/MECH
25	KISHORE D	2201ME13135	III/MECH
26	LAKSHMI NARAYANAN R	2201ME13136	III/MECH
27	INIYAVAN R	2201ME13137	III/MECH
28	MANOJ KUMAR K	2201ME13138	III/MECH
29	RAGUL S	2201ME13139	III/MECH
30	SHOWBAR SATHICK N	2201ME13140	III/MECH
31	VISHNU S	2201ME13141	III/MECH
32	KAMALESH R	2201ME13142	III/MECH
33	PRADEEP P	2201ME13143	III/MECH
34	AJITH C	2201ME13144	III/MECH
35	ARVIND SABAPATHY G	2201ME13145	III/MECH
36	KEERTHIVASAN J	2201ME13146	III/MECH
37	VIGNESHWARAN	2201ME13147	III/MECH
38	SUDHARSAN B	2201ME13148	III/MECH
39	VIJAYAKKUMAR S	2201ME13149	III/MECH
40	SRINIVASAN K	2201ME13150	III/MECH
41	PRIYANRAJ R	2201ME13151	III/MECH
42	PRAVEEN B	2201ME13152	III/MECH
43	KARTHIKEYAN B	2201ME13153	III/MECH
44	HARIHARAN P	2201ME13154	III/MECH
45	VENKATESH D	2201ME13155	III/MECH



**PONNAIYAH RAMAJAYAM INSTITUTE OF
SCIENCE & TECHNOLOGY (PRIST)**
 Declared as DEEMED TO BE UNIVERSITY
 Ufn 3 of UGC Act, 1956

**SCHOOL OF ENGINEERING AND TECHNOLOGY
DEPARTMENT OF MECHANICAL ENGINEERING
ACADEMIC YEAR 2023-2024**

ADD ON COURSE ON MARINE CONSTRUCTION AND WELDING

S. NO	NAME	REG NO	09.12.23	16.12.23	23.12.23	30.12.23	06.01.24	20.01.24	27.01.24	03.02.24	10.02.24
1	MANIKANDAN	2101ME10101	/	/	/	/	/	/	/	/	/
2	TAMILVENTHAN	2101ME10102	/	/	/	/	/	/	/	/	/
3	VINOTHAJ M	2201ME13101	/	/	/	/	/	/	/	/	/
4	HARISHWARAN V	2201ME13102	/	/	/	/	/	/	/	/	/
5	CHANAKIYAN T	2201ME13103	/	/	/	/	/	/	/	/	/
6	SANTHOSH RAMAN K R	2201ME13104	/	/	/	/	/	/	/	/	/
7	ADITHYAN B	2201ME13106	/	/	/	/	/	/	/	/	/
8	MOOVENDAR P	2201ME13111	/	/	/	/	/	/	/	/	/
9	AJITH KUMAR S	2201ME13112	/	/	/	/	/	/	/	AB	/
10	AKASH P	2201ME13113	/	/	/	/	/	/	/	/	/
11	ATCHAYA KUMAR P	2201ME13114	/	/	/	/	/	/	/	/	/
12	DEEPAN J	2201ME13115	/	/	/	/	/	/	/	/	/
13	GANESH VASANTHAKUMAR E	2201ME13116	/	/	/	/	/	/	/	/	/
14	GOPINATHAN S	2201ME13117	/	/	/	/	/	/	/	/	/
15	VENGATESH R	2201ME13125	/	/	/	/	/	/	/	/	/
16	JASVANTH S	2201ME13126	/	/	/	/	/	/	/	/	/
17	SUDHAHARAN H	2201ME13127	/	/	/	/	/	/	/	/	/
18	SURIYA PRAKASH S	2201ME13128	/	/	/	/	/	/	/	/	/
19	KEERTHIVASAN R	2201ME13129	/	/	/	/	/	/	/	/	/
20	AJITHKUMAR C	2201ME13130	/	/	/	/	/	/	/	/	/
21	ABINESH R	2201ME13131	/	/	/	/	/	/	/	/	/
22	AKASH M	2201ME13132	/	/	/	/	/	/	/	/	/
23	GNANA CELSHIYA J	2201ME13133	/	/	/	/	/	/	/	/	/
24	KARTHIK RAJA R	2201ME13134	/	/	/	/	/	/	/	/	/
25	KISHORE D	2201ME13135	/	/	/	/	/	/	/	/	/

26	LAKSHMI NARAYANAN R	2201ME13136	/	/	/	/	/	/	/	/	/
27	INIYAVAN R	2201ME13137	/	/	/	/	/	/	/	/	/
28	MANOJ KUMAR K	2201ME13138	/	/	/	/	/	/	/	/	/
29	RAGUL S	2201ME13139	/	/	/	/	/	/	/	/	/
30	SHOWBAR SATHICK N	2201ME13140	/	/	/	/	/	/	/	/	/
31	VISHNU S	2201ME13141	/	/	/	/	/	/	/	/	/
32	KAMALESH R	2201ME13142	/	/	/	/	/	/	/	/	/
33	PRADEEP P	2201ME13143	/	/	/	/	/	/	/	/	/
34	AJITH C	2201ME13144	/	/	/	/	/	/	/	/	/
35	ARVIND SABAPATHY.G	2201ME13145	/	/	/	/	/	/	/	/	/
36	KEERTHIVASAN J	2201ME13146	/	/	/	/	/	/	/	/	/
37	VIGNESHWARAN	2201ME13147	/	/	/	/	/	/	/	/	/
38	SUDHARSAN B	2201ME13148	/	/	/	/	/	/	/	/	/
39	VIJAYAKKUMAR S	2201ME13149	/	/	/	/	/	/	/	/	/
40	SRINIVASAN K	2201ME13150	/	/	/	/	/	/	/	/	/
41	PRIYANRAJ R	2201ME13151	/	/	/	/	/	/	/	/	/
42	PRAVEEN B	2201ME13152	/	/	/	/	/	/	/	/	/
43	KARTHIKEYAN B	2201ME13153	/	/	/	/	/	/	/	/	/
44	HARIHARAN P	2201ME13154	/	/	/	/	/	/	/	/	/
45	VENKATESH D	2201ME13155	/	/	/	/	/	/	/	/	/



HOD

Department of Mechanical Engineering
 Ponnaiyah Ramajayam Institute of
 Science & Technology (PRIST)
 (Institution Deemed to be University
 i/s 3 of the UGC Act, 1956)
 THANJAVUR - 613 403, TAMIL NADU.



DEAN

School of Engineering and Tech,
 Ponnaiyah Ramajayam Institute of
 Science and Technology (PRIST)
 Deemed to be University
 Vauram, Thanjavur - 613 403.



PONNAIYAH RAMAJAYAM INSTITUTE OF
SCIENCE & TECHNOLOGY (PRIST)

Declared as DEEMED TO BE UNIVERSITY
Uix 3 of UCC Act, 1986

**SCHOOL OF ENGINEERING AND TECHNOLOGY
DEPARTMENT OF MECHANICAL ENGINEERING
ACADEMIC YEAR 2023-2024**

**ADD ON COURSE ON QUALITY ASSURANCE, SIX SIGMA AND LEAN
MANUFACTURING**

S. NO	NAME	REG NO	YEAR/BRANCH
1	VEERAPANDI.N	2301ME10101	I/MECH
2	BHUVANESH.M	2301ME10102	I/MECH
3	BARATH.K	2301ME10103	I/MECH
4	SANJAY.A	2301ME10104	I/MECH
5	MURUGESAN.K	2301ME10105	I/MECH
6	HARIVARMAN.M	2301ME10106	I/MECH
7	MOTHAGAPRIYAN.M	2301ME10107	I/MECH
8	HARIHARAN.B	2301ME10108	I/MECH
9	VEERAPANDI.M	2301ME10109	I/MECH
10	BARATH.M	2301ME10110	I/MECH
11	ASTHIKA.D	2301ME10118	I/MECH
12	BHAVYA.J	2301ME10119	I/MECH
13	GAYANA.T	2301ME10120	I/MECH
14	GANNIKA.R	2301ME10121	I/MECH
15	INAAYA.A	2301ME10122	I/MECH
16	IRYA.K	2301ME10123	I/MECH
17	ARRYA.S	2301ME10124	I/MECH
18	VASUDHEVAN.M	2301ME10125	I/MECH
19	SYED SAMIUDDEEN.N	2301ME10126	I/MECH
20	SIVAKUMAR.J	2301ME10127	I/MECH
21	ANURA.G	2301ME10128	I/MECH
22	NARESH KUMAR.B	2301ME10129	I/MECH
23	SELVAM.M	2301ME10130	I/MECH
24	BENJAMIN.S	2301ME10133	I/MECH
25	GOPAL.K	2301ME10134	I/MECH
26	HASVIKA.A	2301ME10135	I/MECH
27	IHITA.G	2301ME10136	I/MECH
28	ILAKIYA.J	2301ME10137	I/MECH
29	LAKSHITA.K	2301ME10138	I/MECH
30	PARIDHI.S	2301ME10139	I/MECH
31	PARNAVI.A	2301ME10140	I/MECH
32	ISHAANVI.I	2301ME10141	I/MECH
33	SRINITHISH.R	2301ME10142	I/MECH
34	DEENATHAYALAN.K	2301ME10143	I/MECH
35	NAGARAJAN.S	2301ME10144	I/MECH
36	LAKSHMI PRIYA	2301ME10145	I/MECH
37	SOWMIYA.S	2301ME10153	I/MECH
38	ANITHA.V	2301ME10154	I/MECH
39	HARINI.G	2301ME10155	I/MECH
40	MEERASWITHA.B	2301ME10156	I/MECH
41	DHARANI.S	2301ME10157	I/MECH



PONNAIYAH RAMAJAYAM INSTITUTE OF
SCIENCE & TECHNOLOGY (PRIST)

Decreed as deemed to be UNIVERSITY
UO 3 of UEC Act, 1956

SCHOOL OF ENGINEERING AND TECHNOLOGY
DEPARTMENT OF MECHANICAL ENGINEERING
ACADEMIC YEAR 2023-2024

ADD ON COURSE ON QUALITY ASSURANCE, SIX SIGMA AND LEAN MANUFACTURING

S. NO	NAME	REG NO	19.08.23	26.08.23	02.09.23	09.09.23	23.09.23	30.09.23	07.10.23	14.10.23	21.10.23
1	VEERAPANDLN	2301ME10101	/	/	/	/	/	/	/	/	/
2	BHUVANESH.M	2301ME10102	/	/	/	/	/	/	/	/	/
3	BARATH.K	2301ME10103	/	/	/	/	/	/	/	/	/
4	SANJAY.A	2301ME10104	/	/	/	/	/	/	/	/	/
5	MURUGESAN.K	2301ME10105	/	/	/	/	/	/	/	/	/
6	HARIVARMAN.M	2301ME10106	/	/	/	/	/	/	/	/	/
7	MOTHAGAPRIYAN.M	2301ME10107	/	/	/	/	/	/	/	/	/
8	HARIHARAN.B	2301ME10108	/	/	/	/	/	/	/	/	/
9	VEERAPANDUM	2301ME10109	/	/	/	/	/	/	/	/	/
10	BARATH.M	2301ME10110	/	/	/	/	/	/	/	/	/
11	ASTHIKA.D	2301ME10118	/	/	/	/	/	/	/	/	/
12	BHAVYA.J	2301ME10119	/	/	/	/	/	/	/	/	/
13	GAYANA.T	2301ME10120	/	/	/	/	/	/	/	/	/
14	GANNIKA.R	2301ME10121	/	/	/	/	/	/	/	/	/
15	INAAAYA.A	2301ME10122	/	/	/	/	/	/	/	/	/
16	IRYA.K	2301ME10123	/	/	/	/	/	/	/	/	/
17	ARRYA.S	2301ME10124	/	/	/	/	/	/	/	/	/
18	VASUDHEVAN.M	2301ME10125	/	/	/	/	/	/	/	/	/
19	SYED SAMIUDDEEN.N	2301ME10126	/	/	/	/	/	/	/	/	/



**PONNAIYAH RAMAJAYAM INSTITUTE OF
SCIENCE & TECHNOLOGY (PRIST)**

Declared as DEEMED-TO-BE-UNIVERSITY
U/s 3 of UGC Act, 1956

VALLAM, THANJAVUR-613 403

SCHOOL OF ENGINEERING AND TECHNOLOGY

DEPARTMENT OF MECHANICAL ENGINEERING

CERTIFICATE OF PARTICIPATION

This certificate is awarded to Mr./Ms. KATHIRAVAN. K.

IV - YEAR of MECHANICAL ENGINEERING

PRIST DEEMED TO BE UNIVERSITY for successfully participating in the
VALUE ADDED COURSE - GEOMETRIC DIMENSIONING AND TOLERANCE, held
by the department duration 45 HOURS.

DATE: 21.04.2024.

CO-ORDINATOR

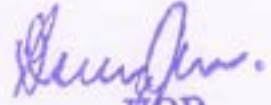
HOD
Department of Mechanical Engineering
Ponnaiyah Ramajayam Institute of
Science & Technology (PRIST)
Vallam, Thanjavur - 613 403

DEAN
School of Engineering and Technology
Ponnaiyah Ramajayam Institute of
Science & Technology



**PONNAIYAH RAMAJAYAM INSTITUTE OF
SCIENCE & TECHNOLOGY (PRIST)**

Declared as DEEMED-TO-BE-UNIVERSITY
U/s 3 of UGC Act, 1956

VALLAM, THANJAVUR-613 403

SCHOOL OF ENGINEERING AND TECHNOLOGY

DEPARTMENT OF MECHANICAL ENGINEERING

CERTIFICATE OF PARTICIPATION

This certificate is awarded to Mr./Ms. SURYA S
IV - YEAR of MECHANICAL ENGINEERING
PRIST DEEMED TO BE UNIVERSITY for successfully participating in the
VALUE ADDED COURSE - PIPING TECHNOLOGY held
by the department duration 45 Hours

DATE: 12.08.2023

CO-ORDINATOR

HOD
Department of Mechanical Engineering
Ponnaiyah Ramajayam Institute of
Science and Technology (PRIST)
(Institution Declared to be Deemed to be University)

DEAN
School of Engineering and Tech
Ponnaiyah Ramajayam Institute of
Science and Technology (PRIST)



**PONNAIYAH RAMAJAYAM INSTITUTE OF
SCIENCE & TECHNOLOGY (PRIST)**

Declared as DEEMED-TO-BE-UNIVERSITY
U/s 3 of UGC Act, 1956

VALLAM, THANJAVUR-613 403

SCHOOL OF ENGINEERING AND TECHNOLOGY

DEPARTMENT OF MECHANICAL ENGINEERING

CERTIFICATE OF PARTICIPATION

This certificate is awarded to Mr./Ms. DINESH B.

II - YEAR. of MECHANICAL ENGINEERING
PRIST DEEMED TO BE UNIVERSITY for successfully participating in the
VALUE ADDED COURSE - AUTOMATION IN AGRICULTURE. held
by the department duration 45 hours.

DATE: 12.08.2023

CO-ORDINATOR

HOD
Department of Mechanical Engineering
Ponnaiyah Ramajayam Institute of Science and Technology
(PRIST) Deemed to be University

DEAN
School of Engineering and Tech.
Ponnaiyah Ramajayam Institute of Science and Technology (PRIST)



**PONNAIYAH RAMAJAYAM INSTITUTE OF
SCIENCE & TECHNOLOGY (PRIST)**

Declared as DEEMED-TO-BE-UNIVERSITY
U/s 3 of UGC Act, 1956

VALLAM, THANJAVUR-613 403

SCHOOL OF ENGINEERING AND TECHNOLOGY

DEPARTMENT OF MECHANICAL ENGINEERING

CERTIFICATE OF PARTICIPATION

This certificate is awarded to Mr./Ms. RISHORE. D.

III - YEAR . of MECHANICAL ENGINEERING
PRIST DEEMED TO BE UNIVERSITY for successfully participating in the
VALUE ADDED COURSE - MARINE CONSTRUCTION AND WELDING held
by the department duration 45 HOURS .

DATE: 10.02.2024 .

CO-ORDINATOR

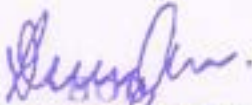
Department of Mechanical Engineering
HOD
Ponnaiyah Ramajayam Institute of
Science and Technology (PRIST)
(Institution Declared as Deemed-to-be University)

DEAN
School of Engineering and Technology
Ponnaiyah Ramajayam Institute of
Science and Technology (PRIST)



**PONNAIYAH RAMAJAYAM INSTITUTE OF
SCIENCE & TECHNOLOGY (PRIST)**

Declared as DEEMED-TO-BE-UNIVERSITY
U/s 3 of UGC Act, 1956

VALLAM, THANJAVUR-613 403

SCHOOL OF ENGINEERING AND TECHNOLOGY

DEPARTMENT OF MECHANICAL ENGINEERING

CERTIFICATE OF PARTICIPATION

This certificate is awarded to Mr./Ms. BHUVANESH M.

2- YEAR of MECHANICAL ENGINEERING

PRIST DEEMED TO BE UNIVERSITY for successfully participating in the

VALUE ADDED COURSE - QUALITY ASSURANCE, SIX SIGMA AND LEAN held

by the department duration 45 HOURS MANUFACTURING.

DATE: 21.10.2023

CO-ORDINATOR

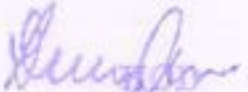
HOD
Department of Mechanical Engineering
Ponnaiyah Ramajayam Institute of Science and Technology
Deemed to be University

DEAN
School of Engineering and Tech.
Ponnaiyah Ramajayam Institute of
Science and Technology
Deemed to be University



**PONNAIYAH RAMAJAYAM INSTITUTE OF
SCIENCE & TECHNOLOGY (PRIST)**

Declared as DEEMED TO BE UNIVERSITY
U/s 3 of UGC Act, 1956

**SCHOOL OF ENGINEERING AND TECHNOLOGY
DEPARTMENT OF COMPUTER SCIENCE AND ENGINEERING**

CIRCULAR

SUB: ADD ON COURSE-Reg.,

It is informed that the department of computer science and engineering is planning to organized a certified course on Digital Marketing on 11.07.23 for the academic year 2023-2024 odd semester. The detailed schedule will be given by the departments. Head of the departments are requested to inform their students about the certified course on Digital Marketing and motivate them to attend the course. HOD's are requested to nominate one faculty member to co-ordinate the same.

Head of the Department
Department of Computer Science
and Engineering
Ponnaiyah Ramajayam Institute of
Science & Technology (PRIST)
(Institution Deemed to be University
U/s 3 of the UGC Act, 1956)
Thiruvannamalai - 610 423, Tamil Nadu

DEAN
School of Engineering and Tech
Ponnaiyah Ramajayam Institute of
Science and Technology (PRIST)
Deemed to be University
Valluvar, Thiruvannamalai - 610 423



**PONNAIYAH RAMAJAYAM INSTITUTE OF
SCIENCE & TECHNOLOGY (PRIST)**

Declared as DEEMED TO BE UNIVERSITY
U/s 3 of UGC Act, 1956

From

The HOD,
Department of CSE,
Prist University,
Vallam, Thanjavur.

To:

The DEAN,
Prist University,
Vallam, Thanjavur.

Respected Sir,

Sub: Requesting Permission for conducting Add on Course – Reg.

I wish to bring to your kind information that the department of computer science and engineering has planned to conduct the following Add On course programme for the academic year 2023-24 odd semester.

As the department is equipped with relevant lab facilities and enterprise in the same field, we are requesting the permission for the conduct of the same.

Duration: 45 Hrs.

Thanking You,

Head of the Department
Department of Computer Science
and Engineering
Ponnaiyah Ramajayam Institute of
Science & Technology (PRIST)
(Institution, Deemed to be University
U/s 3 of the UGC Act, 1956)
THANJAVUR - 613 403, TAMIL NADU

Yours Truly,

HOD/CSE

DEAN
School of Engineering and Tech
Ponnaiyah Ramajayam Institute of
Science and Technology (PRIST)
Deemed to be University
Vallam, Thanjavur - 613 403

DIGITAL MARKETING

COURSE OBJECTIVES:

- To understand the difference between Traditional Marketing and digital Marketing
- To understand and analyze the search engine functions
- To develop a deep knowledge about the Digital marketing platforms and the theoretical aspects of creating a website
- To analyze inbuilt tools for digital Marketing

UNIT I INTRODUCTION TO DIGITAL MARKETING

What is Digital Marketing- Need of Digital Marketing-Digital Marketing Platforms – Understanding digital marketing process- Difference between Traditional Marketing and digital Marketing- tools of Digital marketing - Advantage of Digital Marketing-Digital Marketing Manager Role and functions - How we use both Digital & Traditional Marketing

UNIT II WEBSITE & SEARCH ENGINE

Website –Hosting and Domain– Different platforms for website creation- Introduction to SERP- What are search engines- How search engines work- Major functions of a search engine- What are keywords -Different types of keywords- Google keyword planner tool.

UNIT III MISC TOOLS- GOOGLE WEBMASTER TOOLS

Site Map Creators- Browser-based analysis tools-Page Rank tools-pinging & indexing tools- Dead links identification tools- Open site explorer Domain information/ whois tools- Quick sprout

UNIT IV LEAD MANAGEMENT & DIGITAL MARKETING

Web to lead forms- Web to case forms- Lead generation techniques- Leads are everywhere- Social media and lead gen Inbuilt tools for Digital Marketing- Ip Tracker- CPC reduction (in case of paid ads) Group posting on Social Media platforms.

UNIT V DIGITAL MARKETING SKILL

Search Engine Optimization(SEO)- Search Engine Marketing(SEM).-Social Media Marketing/Optimization- Email Marketing. Website :Product Marketing- Content Writing.



Head of the Department
Department of Computer Science
and Engineering
Ponnaiyah Ramajayam Institute of
Science & Technology (PRIST)
Pondicherry, Chennai - 605 006
Tamil Nadu - 605 006, India



DEAN
School of Engineering and Tech.
Ponnaiyah Ramajayam Institute of
Science and Technology (PRIST)
Deemed to be University
Vallam, Thanjavur - 613 403.

DIGITAL MARKETING

Nowadays, everyone is connected to the internet through their mobile phones and laptop devices. Understanding why digital marketing is essential for businesses aiming to succeed online through modern marketing and for individuals looking to make a career in digital marketing. Digital marketing, or online marketing, strategically promotes brands, products, or services using various digital channels and technologies. With the rise of the internet and mobile devices, businesses now have huge opportunities to reach a global audience.

Whether through innovative search engine marketing (SEM) strategies or advanced digital marketing software, companies can connect with potential customers like never before. Utilizing search engine optimization (SEO), content marketing, social media advertising, and email marketing allows businesses to effectively reach and engage their target audience, driving growth and achieving marketing objectives.



What is **DIGITAL MARKETING**

Digital marketing is the use of online platforms & digital technologies to promote brands, products, or services.

Types of Digital Marketing

Digital marketing encompasses a wide range of strategies and techniques aimed at promoting products or services through digital channels. Here are the key types of digital marketing:

Head of the Department
Department of Computer Science
and Engineering
Ponnalyah Ramajayam Institute of
Science & Technology (P.R.I.T.)
(Institution Deemed to be University
As 3 of the UGC Act 1956)
THANJAVUR - 613 403, TAMIL NADU

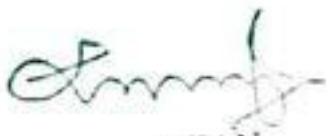
DEAN
School of Engineering and Tech
Ponnalyah Ramajayam Institute of
Science and Technology (P.R.I.T.)
Deemed to be University
Vudam, Thanjavur-613 403

1. Search Engine Optimization (SEO)

SEO involves optimizing a website to improve its visibility in search engine results pages (SERPs). The goal is to attract organic traffic by using relevant keywords, improving site structure, and earning backlinks. Effective SEO can enhance online visibility and drive long-term traffic.

2. Content Marketing

Content marketing focuses on creating and distributing valuable, relevant content to attract and engage a target audience. This includes blog posts, articles, videos, infographics, and eBooks. The objective is to provide useful information that encourages customer loyalty and drives conversions.

3. Social Media Marketing

Social media marketing involves using platforms like Facebook, Instagram, Twitter, LinkedIn, and TikTok to promote products and engage with customers. This type of marketing can include organic content, paid advertising, and influencer partnerships to reach a broader audience and build brand awareness.

Search Engine Optimization (SEO)

SEO, or Search Engine Optimization, is the process of optimizing your website and content to rank higher on search engine results pages (SERPs). It involves keyword research, on-page optimization, and building high-quality backlinks. For example, Moz, a leading SEO software company, uses SEO services to improve their visibility for high-volume keywords like "SEO tools" and "search engine optimization strategies."

Content Marketing

Content marketing focuses on creating and distributing valuable, relevant content to attract and engage a target audience. This includes blog posts, videos, infographics, and eBooks. HubSpot, a prominent digital marketing agency, utilizes a robust content marketing strategy by offering free resources such as blogs, eBooks, and webinars to drive traffic and generate leads for their marketing automation software.

Head of the Department
Department of Computer Science
and Engineering
Ponnaiyah Ramajayam Institute of
Science & Technology (PRIST)
(Autonomous, Deemed to be University)
23 of 100, 601 005, VAILAM,
TAMIL NADU

DEAN
School of Engineering and Tech,
Ponnaiyah Ramajayam Institute of
Science and Technology (PRIST)
Deemed to be University
Vailam, Thanjavur - 613 005

Social Media Marketing

Social media marketing involves using platforms like Facebook, Instagram, Twitter, and LinkedIn to promote products, engage with customers, and build brand awareness. For example, Nike effectively uses social media advertising on Instagram and Twitter to showcase their products, engage with followers, and drive online sales, often targeting their audience with visually compelling ads.



Head of the Department
Department of Computer Science
and Engineering
Ponnaiyah Ramajayam Institute of
Science & Technology (PRIST)
Valliam, Thanjavur - 613 013.



DEAN
School of Engineering and Tech.
Ponnaiyah Ramajayam Institute of
Science and Technology (PRIST)
Deemed to be University
Valliam, Thanjavur - 613 013.



**PONNAIYAH RAMAJAYAM INSTITUTE OF
SCIENCE & TECHNOLOGY (PRIST)**

Declared as DEEMED TO BE UNIVERSITY
U/s 3 of UGC Act, 1956

DEPARTMENT OF COMPUTER SCIENCE AND ENGINEERING

ACADEMIC YEAR 2023-2024

DIGITAL MARKETING

S.NO	NAME OF THE COURSE	REG NO	NAMELIST	YEAR/BRANCH
1.	DIGITAL MARKETING	2001CE10101	NIRANJAN. I	IV CSE
2.		2001CE10102	BALAKRISHNAN .S	IV CSE
3.		2001CE10103	M. MANOTHAN	IV CSE
4.		2001CE10105	MUSTHAK HUSSAIN. J	IV CSE
5.		2001CE10106	THIYAGU. S	IV CSE
6.		2001CE10107	NAVEEN. R	IV CSE
7.		2001CE10108	ASHVANTHAN. J.P	IV CSE
8.		2001CE10109	THANOOSHWARAN. R	IV CSE
9.		2001CE10110	NISHANTH. M.R	IV CSE
10.		2001CE10111	BHUVANESH. K	IV CSE
11.		2001CE10112	MAHESHKUMAR	IV CSE
12.		2001CE10201	SUBIKSHA. S	IV CSE
13.		2001CE10202	RAJASHREE	IV CSE
14.		2004CE10101	DEV AKASH. S	IV CSE
15.		2004CE10102	MOHAMED ABDUL KALAM	IV CSE
16.		2004CE10104	M. HARIHARAN	IV CSE
17.		2101CE13101	AYYAPPAN DEEPAK PETHAIAH. P.M	IV CSE
18.		2101CE13102	BALAMURUGAN. S	IV CSE
19.		2101CE13103	SANJAY KANNAI	IV CSE

Head of the Department
Department of Computer Science
and Engineering
Ponnaiyah Ramajayam Institute of
Science & Technology (PRIST)
(Institution Deemed to be University
U/s 3 of the UGC Act, 1956)
THANJAVUR - 613 403, TAMIL NADU

DEAN
School of Engineering and Tech.
Ponnaiyah Ramajayam Institute of
Science and Technology (PRIST)
Deemed to be University
Vailam, Thanjavur - 613 403

20.	2101CE13104	PRASANNA NARAYANAN. S	IV CSE
21.	2101CE13105	SIVAKUMARAN.V	IV CSE
22.	2101CE13129	VIGNESH.B	IV CSE
23.	1901CE1008	DEENADAYALAN.A	IV CSE
24.	2101CE1001	MOHAMED JAVID.M	IV CSE
25.	2101CE1002	SHAAHEEN S	IV CSE
26.	2101CE1003	MOHAMED HISHAM.P	IV CSE
27.	2101CE1004	AJAY KUMAR.S	IV CSE
28.	2101CE1006	HARI HARAN B	IV CSE
29.	2101CE1007	APARNA.R	IV CSE
30.	2101CE1008	MOHAMED SIDDIK.S	IV CSE
31.	2101CE1009	ANJANA DEVI.S	IV CSE
32.	2101CE1010	SHRI JANAHI	IV CSE
33.	2101CE1011	GOVINDHA RAJ.J	IV CSE
34.	2101CE1012	KARTHIKEYAN.N	IV CSE
35.	2101CE1013	VARUN.M	IV CSE
36.	2101CE1602	VAIRARAMANATHAN.V	IV CSE
37.	2101CE1501	HARIPRASAD.R	IV CSE
38.	2101CE1615	SYED THAMEEM ASHIK Z	IV CSE
39.	2101CE1617	DINESH. L	IV CSE
40.	2101CE1620	HARIHARAN. K	IV CSE
41.	2101CE1014	MOHAMED HAJA.M	IV CSE
42.	2101CE1015	SAHANA. S	IV CSE
43.	2101CE1016	MOHAMED ASIK.S	IV CSE
44.	2101CE1017	AJAY .K	IV CSE
45.	2101CE1018	HARI.M	IV CSE

 Head of the Department
 Department of Computer Science
 and Engineering
 Ponnaiyah Ramajayam Institute of
 Science & Technology (PRIST)
 (Institution Deemed to be University
 by 3 of the UGC Act, 1956)
 THANJAVUR - 612 403, TAMIL NADU

 DEAN
 School of Engineering and Tech.
 Ponnaiyah Ramajayam Institute of
 Science and Technology (PRIST)
 Deemed to be University
 Vailam, Thanjavur - 613 -

46.		210ICE1019	AKSHAYA A	IV CSE
47.		210ICE1020	MOHAMED ASIF.S	IV CSE
48.		210ICE1021	PRAKASH.V	IV CSE
49.		210ICE1022	HARSHA.B	IV CSE
50.		210ICE1023	MOHAMED HISHAM.S	IV CSE
51.		210ICE1024	NISHA.D	IV CSE
52.		210ICE1025	DIVYABHARATH.R	IV CSE
53.		210ICE1026	AGALYA.S	IV CSE
54.		210ICE1027	VINOTH.M	IV CSE
55.		210ICE1028	VHIAN.J	IV CSE
56.		210ICE1029	PRATHIKSHA.S	IV CSE
57.		210ICE1030	PRAVEEN.M	IV CSE
58.		210ICE1031	ROSHIGA DEVI.R.N	IV CSE

 Head of the Department
 Department of Computer Science
 and Engineering
 Ponnaiyah Ramajayam Institute of
 Science & Technology (P.R.I.S.T.)
 (Insulation Deemed to be University
 's 3 of the UGC Act 1956)
 THANJAVUR - 613 403, TAMIL NADU

 DEAN
 School of Engineering and Tech.
 Ponnaiyah Ramajayam Institute of
 Science and Technology (PRIST)
 Deemed to be University
 Vailam, Thanjavur-613 403.



**PONNAIYAH RAMAJAYAM INSTITUTE OF
SCIENCE & TECHNOLOGY (PRIST)**

Declared as DEEMED TO BE UNIVERSITY
Under Sec 3 of UGC Act, 1956

DEPARTMENT OF COMPUTERSCIENCE AND ENGINEERING

ACADEMIC YEAR 2023-2024

TIME TABLE - DIGITAL MARKETING

MONTH	DATE	HOURS
JULY	13.07.23	45HRS
	14.07.23	
	17.07.23	
	18.07.23	
	19.07.23	
	20.07.23	
	21.07.23	
	24.07.23	
	25.07.23	

Head of the Department
Department of Computer Science
and Engineering
Ponnaiyah Ramajayam Institute of
Science & Technology (PRIST)
(Insulation Deemed to be University
Under Sec 3 of the UGC Act, 1956)
THANJAVUR - 613 403, TAMIL NADU

DEAN
School of Engineering and Tech.
Ponnaiyah Ramajayam Institute of
Science and Technology (PRIST)
Deemed to be University
Thanjavur, Tamil Nadu - 613 403



**PONNAIYAH RAMAJAYAM INSTITUTE OF
SCIENCE & TECHNOLOGY (PRIST)**

Declared as DEEMED TO BE UNIVERSITY
Dis 3 of UGC Act, 1956

**SCHOOL OF ENGINEERING AND TECHNOLOGY
DEPARTMENT OF COMPUTER SCIENCE AND ENGINEERING**

CIRCULAR

SUB: ADD ON COURSE-Reg.,

It is informed that the department of computer science and engineering is planning to organized a certified course on Data Science on 08.09.23 for the academic year 2023-2024 odd semester. The detailed schedule will be given by the departments. Head of the departments are requested to inform their students about the certified course on Data Science and motivate them to attend the course. HOD's are requested to nominate one faculty member to co-ordinate the same.

**Head of the Department
Department of Computer Science
and Engineering
Pennaiyah Ramajayam Institute of
Science & Technology (PRIST)
(Insulation Deemed to be University
Dis 3 of the UGC Act, 1956)
THANJAVUR - 613 403, TAMIL NADU**

**DEAN
School of Engineering and Tech.
Pennaiyah Ramajayam Institute of
Science and Technology (PRIST)
Deemed to be University
Vallam, Thanjavur-613 403.**



**PONNAIYAH RAMAJAYAM INSTITUTE OF
SCIENCE & TECHNOLOGY (PRIST)**

DECLARED AS DEEMED TO BE UNIVERSITY
U/S 3 OF UGC ACT, 1956

From
The HOD,
Department of CSE,
Prist University,
Vallam, Thanjavur.

To:
The DEAN,
Prist University,
Vallam, Thanjavur.

Respected Sir,

Sub:- Requesting Permission for conducting Add on Course – Reg.

I wish to bring to your kind information that the department of computer science and engineering has planned to conduct the following Add On course programme for the academic year 2023-24 odd semester.

As the department is equipped with relevant lab facilities and enterprise in the same field, we are requesting the permission for the conduct of the same.

Duration: 45 Hrs.

Thanking You,

Yours Truly,

HOD/CSE

Head of the Department
Department of Computer Science
and Engineering
Ponnaiyah Ramajayam Institute of
Science & Technology (PRIST)
(Institution Deemed to be University
U/s 3 of the UGC Act, 1956)
THANJAVUR - 613 403, TAMIL NADU

DEAN
School of Engineering and Tech.
Ponnaiyah Ramajayam Institute of
Science and Technology (PRIST)
Deemed to be University
Vallam, Thanjavur - 613 403.

DATA SCIENCE

COURSE OUTCOMES:

- To understand the techniques and processes of data science
- To apply descriptive data analytics
- To visualize data for various applications
- To understand inferential data analytics
- To analysis and build predictive models from data

UNIT I INTRODUCTION TO DATA SCIENCE

Need for data science – benefits and uses – facets of data – data science process – setting the research goal – retrieving data – cleansing, integrating, and transforming data – exploratory data analysis – build the models – presenting and building applications.

UNIT II DESCRIPTIVE ANALYTICS

Frequency distributions – Outliers – interpreting distributions – graphs – averages – describing variability – interquartile range – variability for qualitative and ranked data – Normal distributions – z scores – correlation – scatter plots – regression – regression line .

UNIT III INFERENCE STATISTICS

Populations – samples – random sampling – Sampling distribution- standard error of the mean - Hypothesis testing – z-test – z-test procedure – decision rule – calculations – decisions – interpretations

UNIT IV ANALYSIS OF VARIANCE

t-test for one sample – sampling distribution of t – t-test procedure – t-test for two independent samples – p-value – statistical significance – t-test for two related samples, F-test – ANOVA – Two- factor experiments – three f-tests – two-factor ANOVA – Introduction to chi-square tests.

UNIT V PREDICTIVE ANALYTICS

Linear least squares – implementation – goodness of fit – testing a linear model – weighted resampling, Regression using StatsModels – multiple regression – nonlinear relationships – logistic regression .



Head of the Department
Department of Computer Science
and Engineering
Ponnaiyah Ramajayam Institute of
Science & Technology
(Institution Deemed to be University)
Sub 3 of the UGC Act
THANJAVUR - 613 403, Tamil Nadu



DEAN
School of Engineering and Tech.
Ponnaiyah Ramajayam Institute of
Science and Technology (PRIST)
Deemed to be University
Vaiiam, Thanjavur - 613 403.

DATA SCIENCE

In a world of data space where organizations deal with petabytes and exabytes of data, the era

of Big Data emerged, and the essence of its storage also grew. It was a great



challenge and concern for industries for the storage of data until 2010. Now when frameworks like Hadoop and others solved the problem of storage, the focus shifted to the processing of data. Data Science plays a big role here. All those fancy Sci-fi movies you love to watch around can be turned into reality by Data Science. Nowadays its growth has been increased in multiple ways and thus one should be ready for our future by learning what it is and how can we add value to it.

Data science is not a one-step process such that you will get to learn it in a short time and call ourselves a Data Scientist. It's passes from many stages and every element is important. One should always follow the proper steps to reach the ladder. Every step has its value and it counts in your model. Buckle up in your seats and get ready to learn about those steps.

Head of the Department
Department of Computer Science
and Engineering
Ponnalyah Ramajayam Institute of
Science & Technology (PRT-1)
(Institution Deemed to be University
As 3 of the UGC Act, 1956)
THANJAVUR - 613 403, TAMIL NADU

DEAN
School of Engineering and Tech,
Ponnalyah Ramajayam Institute of
Science and Technology (PRT-1)
(Institution Deemed to be University
As 3 of the UGC Act, 1956)
Vandri, Thanjavur - 613 403.

1. Problem Statement:

No work start without motivation, Data science is no exception though. It's really important to declare or formulate your problem statement very clearly and precisely. Your whole model and it's working depend on your statement. Many scientist considers this as the main and much important step of Data Science. So make sure what's your problem statement and how well can it add value to business or any other organization.

2. Data Collection:

After defining the problem statement, the next obvious step is to go in search of data that you might require for your model. You must do good research, find all that you need. Data can be in any form i.e unstructured or structured. It might be in various forms like videos, spreadsheets, coded forms, etc. You must collect all these kinds of sources.

3. Data Cleaning:

As you have formulated your motive and also you did collect your data, the next step to do is cleaning. Yes, it is! Data cleaning is the most favorite thing for data scientists to do. Data cleaning is all about the removal of missing, redundant, unnecessary and duplicate data from your collection. There are various tools to do so with the help of programming in either R or Python. It's totally on you to choose one of them. Various scientist have their opinion on which to choose. When it comes to the statistical part, R is preferred over Python, as it has the privilege of more than 12,000 packages. While python is used as it is fast, easily accessible and we can perform the same things as we can in R with the help of various packages.

4. Data Analysis and Exploration:

It's one of the prime things in data science to do and time to get inner Holmes out. It's about analyzing the structure of data, finding hidden patterns in them, studying behaviors, visualizing the effects of one variable over others and then concluding. We can explore the data with the help of various graphs formed with the help of libraries using any programming language. In R, GGplot is one of the most famous models while Matplotlib in Python.



Head of the Department
Department of Computer Science
and Engineering
Ponnaiyah Ramajayam Institute of
Science & Technology
(Established under the University
of Madras Act, 1957)
Pondicherry - 605 006, India



DEAN
School of Engineering and Tech.
Ponnaiyah Ramajayam Institute of
Science and Technology (PRIST)
Deemed to be University
Vellam, Thanjavur - 612 011

5. Data Modelling:

Once you are done with your study that you have formed from data visualization, you must start building a hypothesis model such that it may yield you a good prediction in future. Here, you must choose a good algorithm that best fit to your model. There different kinds of algorithms from regression to classification, SVM(Support vector machines), Clustering, etc. Your model can be of a Machine Learning algorithm. You train your model with the train data and then test it with test data. There are various methods to do so.

6. Optimization and Deployment:

You followed each and every step and hence build a model that you feel is the best fit. But how can you decide how well your model is performing? This where optimization comes. You test your data and find how well it is performing by checking its accuracy. In short, you check the efficiency of the data model and thus try to optimize it for better accurate prediction. Deployment deals with the launch of your model and let the people outside there to benefit from that. You can also obtain feedback from organizations and people to know their need and then to work more on your model.

Head of the Department
Department of Computer Science
and Engineering
Ponnalyah Ramajayam Institute of
Science & Technology (P.R.I.S.T.)
(Insulation Deemed to be University
under Section 3 of the UGC Act, 1956)
THANJAVUR - 613 403, TAMIL NADU

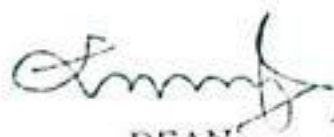
DEAN
School of Engineering and Tech.
Ponnalyah Ramajayam Institute of
Science and Technology (PRIST)
Deemed to be University
Vallam, Thanjavur - 613 403.



**PONNAIYAH RAMAJAYAM INSTITUTE OF
SCIENCE & TECHNOLOGY (PRIST)**

Declared as DEEMED TO BE UNIVERSITY
By 3 of UGC Act, 1956

DEPARTMENT OF COMPUTER SCIENCE AND ENGINEERING

ACADEMIC YEAR 2023-2024

DATA SCIENCE

S.NO	NAME OF THE COURSE	REGNO	NAME LIST	YEAR/BRANC II
1.	DATA SCIENCE	2101CE10201	R.KEERATHANA	III CSE
2.		2101CE10202	S.ABINAYA	III CSE
3.		2101CE10101	S.AJAY KUMAR	III CSE
4.		2101CE10102	N.SURYA PRAKASH	III CSE
5.		2101CE10103	R.PRAVEEN	III CSE
6.		2101CE10104	S.ABISHAKE	III CSE
7.		2210CE13101	R.BALAJI	III CSE
8.		2201CE13102	A.DINESH KUMAR	III CSE
9.		2101CE13201	A.BAVA DIARANI	III CSE
10.		2101CE13202	P.GOWRI BHAVANA	III CSE
11.		2201CE13106	M.SUGANEESHWARAN	III CSE
12.		2201CE13109	U.RAGUL	III CSE
13.		2101CE13203	M.VISHVADHARSHINI	III CSE
14.		2101CE13204	G.SURIYA	III CSE
15.		2201CE13103	J.NOOR MOHAMED	III CSE
16.		2201CE13104	N.VIGNESH	III CSE
17.		2201CE13105	K.S.NAVEEN	III CSE
18.		2101CE13231	A.VIGNESH KUMAR	III CSE
19.		2201CE13107	VENKATESHWARAN	III CSE

Head of the Department
Department of Computer Science
and Engineering
Ponnaiyah Ramajayam Institute of
Science & Technology (PRIST)
(Institutes Deemed to be University
By 3 of UGC Act, 1956)
Thanjavur - 612 002, Tamil Nadu, India

DEAN
School of Engineering and Tech.
Ponnaiyah Ramajayam Institute of
Science and Technology (PRIST)
Deemed to be University
Vallam, Thanjavur - 612 002

20.				
21.		2201CE13110	G. PARVIN	III CSE
22.		2101CE13206	S. SUSHMA	III CSE
23.		2201CE13111	P. GOWTHAM	III CSE
24.		2201CE13112	R. SATHIS KANNAN	III CSE
		2201CE13113	RIYAS J	III CSE

 Head of the Department
 Department of Computer Science
 and Engineering
 Ponnaiyah Ramalingam Institute of
 Science & Technology (P.R.I.S.T.)
 Constituent College to the Anna University
 at 3 of the 1st Cross Street,
 THANJAVUR - 613 403, TAMIL NADU

 DEAN
 School of Engineering and Tech.
 Ponnaiyah Ramalingam Institute of
 Science and Technology (P.R.I.S.T.)
 Deemed to be University
 Vanam, Thanjavur - 613 403.



**PONNAIYAH RAMAJAYAM INSTITUTE OF
SCIENCE & TECHNOLOGY (PRIST)**

Declared as DEEMED TO BE UNIVERSITY
U/A 3 of UGC Act, 1956

DEPARTMENT OF COMPUTER SCIENCE AND ENGINEERING

ACADEMIC YEAR 2023-2024

TIME TABLE - DATA SCIENCE

MONTH	DATE	HOURS
SEPTEMBER	12.09.23	45 HRS
	13.09.23	
	14.09.23	
	15.09.23	
	18.09.23	
	19.09.23	
	20.09.23	
	21.09.23	
	22.09.23	

Head of the Department
Department of Computer Science
and Engineering
Ponnaiyah Ramajayam Institute of
Science & Technology (PRIST)
(Institution Deemed to be University
U/A 3 of the UGC Act, 1956)
THANJAVUR - 613 403, Tamil Nadu

DEAN
School of Engineering and Tech.
Ponnaiyah Ramajayam Institute of
Science and Technology (PRIST)
Deemed to be University
Vellam, Thanjavur - 613 403.



**PONNAIYAH RAMAJAYAM INSTITUTE OF
SCIENCE & TECHNOLOGY (PRIST)**

DECLARED AS DEEMED TO BE UNIVERSITY
BY 3 OF HIG Act, 1956

**SCHOOL OF ENGINEERING AND TECHNOLOGY
DEPARTMENT OF COMPUTER SCIENCE AND ENGINEERING**

CIRCULAR

SUB: ADD ON COURSE-Reg.,

It is informed that the department of computer science and engineering is planning to organized a certified course on Ethical Hacking on 03.11.23 for the academic year 2023-2024 odd semester. The detailed schedule will be given by the departments. Head of the departments are requested to inform their students about the certified course on Ethical Hacking and motivate them to attend the course. HOD's are requested to nominate one faculty member to co-ordinate the same.

Head of the Department
Department of Computer Science
and Engineering,
Ponnaiyah Ramajayam Institute of
Science & Technology,
Institution Deemed to be University
3 of 1956 Act,
THANJAVUR - 613 403.

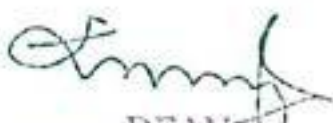
DEAN
School of Engineering and Tech,
Ponnaiyah Ramajayam Institute of
Science and Technology (PRIST)
Deemed to be University
Vallam, Thanjavur - 613 403.



**PONNAIYAH RAMAJAYAM INSTITUTE OF
SCIENCE & TECHNOLOGY (PRIST)**

Declared as DEEMED TO BE UNIVERSITY
Under 3 of UGC Act, 1956

From

The HOD,
Department of CSE,
Prist University,
Vallam, Thanjavur.

To:

The DEAN,
Prist University,
Vallam, Thanjavur.

Respected Sir,

Sub:- Requesting Permission for conducting Add on Course – Reg.

I wish to bring to your kind information that the department of computer science and engineering has planned to conduct the following Add On course programme for the academic year 2023-24 odd semester.

As the department is equipped with relevant lab facilities and enterprise in the same field, we are requesting the permission for the conduct of the same.

Duration: 45 Hrs.

Thanking You,

Yours Truly,
HOD/CSE

Head of the Department
Department of Computer Science
and Engineering
Ponnaiyah Ramajayam Institute of
Science & Technology (PRIST)
(Institution Deemed to be University
Under 3 of the UGC Act, 1956)
THANJAVUR - 612 402, Tamil Nadu

DEAN
School of Engineering and Tech.
Ponnaiyah Ramajayam Institute of
Science and Technology (PRIST)
Deemed to be University
Vallam, Thanjavur - 612 402.

ETHICAL HACKING



Who is a Certified Ethical Hacker?

A Certified Ethical Hacker is a specialist typically working in a red team environment, focused on attacking computer systems and gaining access to networks, applications, databases, and other critical data on secured systems. A CEH® understands attack strategies, the use of creative attack vectors, and mimics the skills and creativity of malicious hackers. Unlike malicious hackers and actors, Certified Ethical Hackers operate with permission from the system owners and take all precautions to ensure the outcomes remain confidential. Bug bounty researchers are expert ethical hackers whose attack skills to uncover vulnerabilities in the systems.

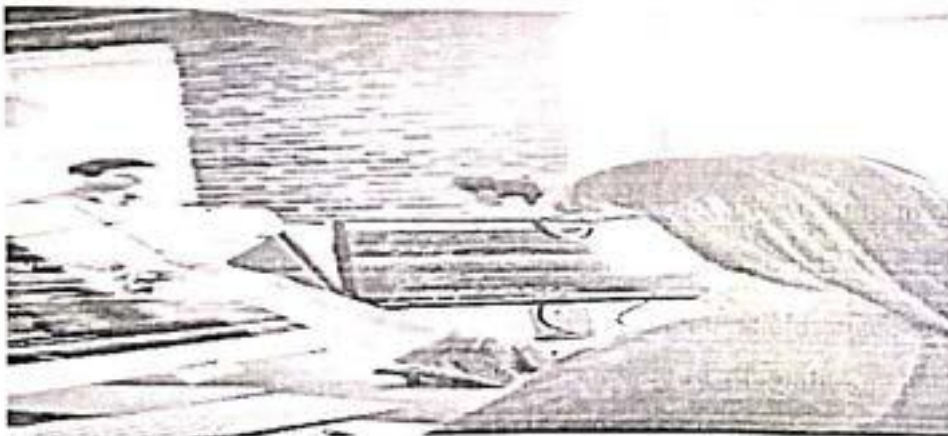

Head of the Department
Department of Computer Science
and Engineering
Ponnaiyah Ramajayam Institute of
Science & Technology (PRIST)
(Autonomous, Deemed to be University)
Vellam, Thanjavur - 613 403.



DEAN
School of Engineering and Tech.
Ponnaiyah Ramajayam Institute of
Science and Technology (PRIST)
Deemed to be University
Vellam, Thanjavur - 613 403.

What is CEH® v12?

The Certified Ethical Hacker has been battle-hardened over the last 20 years, creating hundreds of thousands of Certified Ethical Hackers employed by top companies, militaries, and governments worldwide. In its 12th version, the Certified Ethical Hacker provides comprehensive training, hands-on learning labs, practice cyber ranges for engagement, certification assessments, cyber competitions, and opportunities for continuous learning into one comprehensive program curated through our new learning framework: 1. Learn 2. Certify 3. Engage 4. Compete

RECONNAISSA

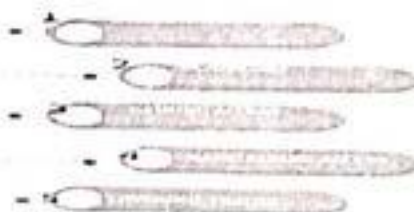
The CEH® v12 is a specialized and one-of-a-kind training program to teach you everything you need to know about ethical hacking with hands-on training, labs, assessment, a mock engagement (practice), and global hacking competition. Stay on top of the game with the most in-demand skills required to succeed in the field of cyber security.



COURSE OUTCOMES:

At the end of this course, the students will be able:

1. To express knowledge on basics of computer based vulnerabilities
2. To gain understanding on different foot printing, reconnaissance and scanning methods.
3. To demonstrate the enumeration and vulnerability analysis methods
4. To gain knowledge on hacking options available in Web and wireless applications.
5. To acquire knowledge on the options for network protection.

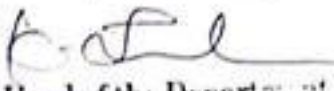
Head of the Department
Department of Computer Science
and Engineering
Pennalyah Ramaswami Institute of
Science & Technology (PRTIST)
(Autonomous Deemed to be University)
A-1 of 4th Floor, 1st
THANJAVUR - 612 404, Tamil Nadu

DEAN
School of Engineering and Tech.
Pennalyah Ramaswami Institute of
Science and Technology (PRTIST)
Deemed to be University
Vilvam, Thanjavur - 613 403.

ETHICAL HACKING

UNIT I INTRODUCTION TO HACKING

Introduction to Hacking - Important Terminologies - Penetration Test - Vulnerability Assessments versus Penetration Test - Pre-Engagement - Rules of Engagement - Penetration Testing Methodologies - OSSTMM - NIST - OWASP - Categories of Penetration Test - Types of Penetration Tests - Vulnerability Assessment Summary - Reports .

UNIT II FOOT PRINTING AND RECONNAISSANCE

Scanning Networks - Enumeration - Vulnerability Analysis - System Hacking - Malware Threats - Sniffing.

UNIT-III NETWORK ATTACKS

Vulnerability Data Resources - Exploit Databases - Network Sniffing - Types of Sniffing - Promiscuous versus Non promiscuous Mode - MITM Attacks - ARP Attacks - Denial of Service Attacks - Hijacking Session with MITM Attack - SSL Strip: Stripping .

UNIT IV TYPES OF HACKERS

Black Hat Hacker - White Hat Hacker - Grey Hat Hacker - Hacking Process - Foot Printing - Scanning - Gaining Access - Maintaining Access.

UNIT V WIRELESS AND WEB HACKING

Wireless Hacking - Introducing Aircrack- Cracking the WEP - Cracking a WPA/WPA2 Wireless Network Using Aircrack-ng - Evil Twin Attack - Causing Denial of Service on the Original AP.



Head of the Department
Department of Computer Science
and Engineering
Ponnaiyah Ramajayam Institute of
Science & Technology (PRIST)
Institution Deemed to be University
153 of the Dist. of
THANJAVUR - 613 403, TAMIL NADU



DEAN
School of Engineering and Tech.
Ponnaiyah Ramajayam Institute of
Science and Technology (PRIST)
Deemed to be University
Vallam, Thanjavur - 613 403.



**PONNAIYAH RAMAJAYAM INSTITUTE OF
SCIENCE & TECHNOLOGY (PRIST)**

Declared as DEEMED TO BE UNIVERSITY
U-3 of UGC Act, 1956

DEPARTMENT OF COMPUTER SCIENCE AND ENGINEERING

ACADEMIC YEAR 2023-2024

ETHICAL HACKING

S.NO	NAME OF THE COURSE	REGNO	NAMELIST	YEAR/BRANCH
1.	ETHICAL HACKING	2201CE13114	SHEIK .H	III CSE
2.		2201CE13115	KANISHA .R	III CSE
3.		2201CE13116	BHARATHI .D	III CSE
4.		2201CE13117	ARASAN .J	III CSE
5.		2201CE13118	ARUN .T	III CSE
6.		2201CE13119	AMIRTHEYA .R	III CSE
7.		2201CE13120	BASITH .S	III CSE
8.		2201CE13121	ALTHAF .S	III CSE
9.		2201CE13122	KIRUTHIGA .N	III CSE
10.		2201CE13123	WASIFUL HAQ .A.H	III CSE
11.		2201CE13124	ASHOK BALU .U	III CSE
12.		2201CE13125	ABDULLA SHA .M	III CSE
13.		2201CE13126	SHAKSHI .S	III CSE
14.		2201CE13127	ATCHAYA .K	III CSE
15.		2201CE13128	BRINDHA .L	III CSE
16.		2201CE13129	SURYAPRAKASH .K	III CSE
17.		2201CE13130	NAVEEN .R	III CSE

[Signature]
Head of the Department
Department of Computer Science
and Engineering
Ponnaiyah Ramajayam Institute of
Science & Technology (PRIST)
Institution Deemed to be University
U-3 of UGC Act, 1956
Valluvar Street, Valluvar Nagar,
Valluvar Nagar, Valluvar Nagar, Valluvar Nagar

PRIST
School of Engineering and Technology
Ponnaiyah Ramajayam Institute of
Science and Technology (PRIST)
Deemed to be University
Valluvar Nagar, Valluvar Nagar - 613 401

18.		2201CE1014	MOHAMED HAJA M	III CSE
19.		2201CE13131	MURALIDHARAN.V	III CSE
20.		2201CE13132	SARDAR.I	III CSE
21.		2201CE13133	TAMILSELVI R	III CSE
22.		2201CE13134	MURUGAN.S	III CSE
23.		2201CE13135	SARANYA T	III CSE
24.		2201CE13136	RAVICHANDRAN.N	III CSE
25.		2201CE13137	ANSARIM	III CSE
26.		2201CE13138	RAMALINGAM.V	III CSE
27.		2201CE13139	LATHA R	III CSE
28.		2201CE13140	AMIRTHALINGAM.N	III CSE
29.		2201CE13141	RAGHAVI.N	III CSE
30.		2201CE13142	DHANESHI N	III CSE
31.		2201CE13143	SAMU K	III CSE
32.		2201CE13144	ASHOK KUMAR M	III CSE
33.		2201CE13145	SANTHIYA R	III CSE
34.		2201CE13146	LEGAN ALFANRO R	III CSE

 Head of the Department
 Department of Computer Science
 and Engineering
 Ponnaiyah Ramajayam Institute of
 Science & Technology (PRIST)
 (Autonomous Deemed to be University)
 116 B of the 1040 Avenue,
 THANJAVUR - 613 403, TAMIL NADU

 DEAN
 School of Engineering and Tech.
 Ponnaiyah Ramajayam Institute of
 Science and Technology (PRIST)
 Deemed to be University
 Vallam, Thanjavur-613 403.



**PONNAIYAH RAMAJAYAM INSTITUTE OF
SCIENCE & TECHNOLOGY (PRIST)**

Declared as DEEMED TO BE UNIVERSITY
U/s 3 of UGC Act, 1956

DEPARTMENT OF COMPUTER SCIENCE AND ENGINEERING

ACADEMIC YEAR 2023-2024

TIME TABLE - ETHICAL HACKING

MONTH	DATE	HOURS
NOVEMBER	07.11.23	45HRS
	08.11.23	
	09.11.23	
	10.11.23	
	13.11.23	
	14.11.23	
	15.11.23	
	16.11.23	
	17.11.23	

Head of the Department
Department of Computer Science
and Engineering
Ponnaiyah Ramajayam Institute of
Science & Technology
(Institution Declared as Deemed to be University
U/s 3 of the UGC Act, 1956)
THANJAVUR - 613 403, Tamil Nadu

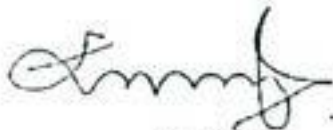
DEAN
School of Engineering and Tech.
Ponnaiyah Ramajayam Institute of
Science and Technology (PRIST)
Deemed to be University
Vairam, Thanjavur - 613 403.



**PONNAIYAH RAMAJAYAM INSTITUTE OF
SCIENCE & TECHNOLOGY (PRIST)**

Declared as DEEMED TO BE UNIVERSITY
ON 3 of UGC Act, 1956

**SCHOOL OF ENGINEERING AND TECHNOLOGY
DEPARTMENT OF COMPUTER SCIENCE AND ENGINEERING**

CIRCULAR

SUB: ADD ON COURSE-Req.

It is informed that the department of computer science and engineering is planning to organized a certified course on Virtual Reality on 05.12.23 for the academic year 2023-2024 odd semester. The detailed schedule will be given by the departments. Head of the departments are requested to inform their students about the certified course on Virtual Reality and motivate them to attend the course. HOD's are requested to nominate one faculty member to co-ordinate the same.

**Head of the Department
Department of Computer Science
and Engineering
Ponnaiyah Ramajayam Institute of
Science & Technology (PRIST)
(Insulation Deemed to be University
16 3 of the UGC Act, 1956)
THANJAVUR - 613 403, TAMILNADU**

**DEAN
School of Engineering and Tech.
Ponnaiyah Ramajayam Institute of
Science and Technology (PRIST)
Deemed to be University
Vallam, Thanjavur - 613 403.**



**PONNAIYAH RAMAJAYAM INSTITUTE OF
SCIENCE & TECHNOLOGY (PRIST)**

DEPARTMENT OF COMPUTER SCIENCE AND ENGINEERING
PRIST UNIVERSITY
VALLAM, THANJAVUR.

From

The HOD,
Department of CSE,
Prist University,
Vallam, Thanjavur.

To:

The DEAN,
Prist University,
Vallam, Thanjavur.

Respected Sir,

Sub:- Requesting Permission for conducting Add on Course – Reg.

I wish to bring to your kind information that the department of computer science and engineering has planned to conduct the following Add On course programme for the academic year 2023-24 odd semester.

As the department is equipped with relevant lab facilities and enterprise in the same field, we are requesting the permission for the conduct of the same.

Duration: 45 Hrs.

Thanking You,

Yours Truly,
HOD/CSE

Head of the Department
Department of Computer Science
and Engineering
Ponnaiyah Ramajayam Institute of
Science & Technology (PRIST)
(Institution Deemed to be University)
No. 3 of the UGC Act, 1956
THANJAVUR - 612 004, Tamil Nadu

DEAN
School of Engineering and Tech.
Ponnaiyah Ramajayam Institute of
Science and Technology (PRIST)
Deemed to be University
Vallam, Thanjavur - 612 004

VIRTUAL REALITY

Virtual Reality (VR) is a technology that creates a simulated environment, allowing users to feel like they are in a different place or world. VR puts you inside a computer-generated world that feels real. It does this by using special equipment that covers your eyes and sometimes your ears called VR Headset. Virtual Reality creates a believable, interactive 3D environment that you can explore and interact with, making you feel like you are really there.

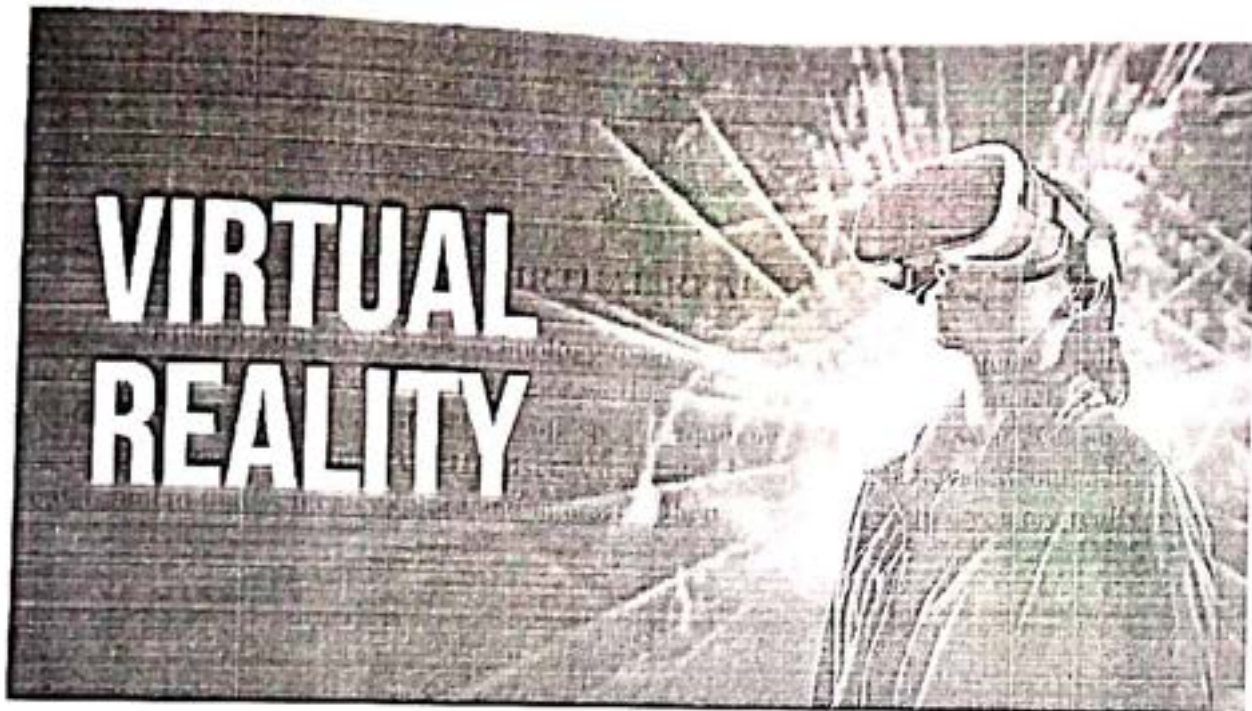

This is made possible by putting on a head-mounted display that sends a form of input tracking. The display is split between the eyes and thus creates a stereoscopic 3D effect with stereo sound to give you a graphic experience.

The technology feeds in the images of the objects taken at slightly different angles which creates an impression of depth and solidity. The LCD or OLED panels inside are refracted by lenses completely fill the field of vision with what is to be displayed and experienced. Together with the technology and the input tracking, it creates an immersive and exciting believable world that the computer generates. What we know today as VR, has been existing for decades now. Taking you back to when 360° paintings took the world by surprise, giving a virtual element, VR merely is 'The Wise Guy' of the digital world. It creates a world that neither functions according to you, nor does it respond to your actions. It gives you a first-hand experience with

Head of the Department
Department of Computer Science
and Engineering
Ponnaiyah Ramajayam Institute of
Science & Technology (P.R.I.S.T.)
(Institution Deemed to be University
No. 3 of the UGC Act, 1956)
TANJAVUR - 613 403, TAMIL NADU

DEAN
School of Engineering and Tech.
Ponnaiyah Ramajayam Institute of
Science and Technology (P.R.I.S.T.)
Deemed to be University
Vallam, Thanjavur-613 403

even the after-effects of an event along with the ability to interact and interrelate with the world created. This technology holds vast potential insights into the workings of the Human Brain.

Types of Virtual Reality (VR)

On the basis of the most important feature of VR i.e. immersion and the types of systems and interfaces used, The VR systems can be classified into 3 types :

1. Immersive
2. Semi-immersive
3. Non - immersive

1. Immersive VR system

Immersive VR system is closest to the virtual environment. It makes us experience the highest level of immersion. This VR system is expensive than others. It provides the closest feeling of being in virtual world. Tools and gadgets used in this system are advanced and not so common to use.

2. Semi - immersive VR system

Semi - immersive VR systems also make us to experience a high level of immersion but the tools and gadgets used are not so advanced and costly. Tools and gadgets used in this system are common to us and utilize physical models.

3. Non-immersive VR system

Non-immersive VR system is the least immersive and least immersive VR system. It is not expensive to use this system. It is also known as desktop VR system because the gadgets used are limited to glasses and display monitors and it uses the least expensive components.



Head of the Department
Department of Computer Science
and Engineering
Pennalyah Ramajayam Institute of
Science & Technology
(Innovative Department, Research & Creativity)
PENNALYAH RAMAJAYAM INSTITUTE OF SCIENCE & TECHNOLOGY

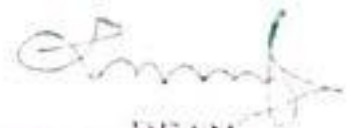

DEAN
School of Engineering and Tech.
Pennalyah Ramajayam Institute of
Science and Technology (PRIST)
Dedicated to the University
Vellore, Tamilnadu - 611 342

VIRTUAL REALITY

UNIT - I INTRODUCTION TO VIRTUAL REALITY (VR)

Defining Virtual Reality, Key elements of virtual reality experience, Virtual Reality, Telepresence, Augmented Reality and Cyberspace.

UNIT-II INPUT DEVICES

(Trackers, Navigation, and Gesture Interfaces): Three-dimensional position trackers, navigation and manipulation, Interfaces and gesture interfaces.

UNIT-III MODELING

Geometric modeling, Kinematics modeling, Physical modeling, Behaviour modeling, Model management.

UNIT-IV AUGMENTED REALITY (AR)

Taxonomy, Technology and Features of Augmented Reality, AR Vs VR, Challenges with AR, AR systems and functionality, Augmented Reality Methods, Visualization Techniques for Augmented Reality, Enhancing interactivity in AR Environments.

UNIT-V INTERACTION & AUDIO

Interaction Motor Programs and Remapping, Locomotion, Manipulation, Social Interaction, Audio -The Physics of Sound, The Physiology of Human Hearing, Auditory Perception, Auditory Rendering.

Head of the Department
Department of Computer Science
and Engineering
Ponnaiyah Ramajayam Institute of
Science & Technology
(Institution Deemed to be University
of the UGC)
Vellam, Thanjavur - 613 403.

DEAN
School of Engineering and Tech.
Ponnaiyah Ramajayam Institute of
Science and Technology (PRIST)
Deemed to be University
Vellam, Thanjavur - 613 403.



PONNAIYAH RAMAJAYAM INSTITUTE OF
SCIENCE & TECHNOLOGY (PRIST)

Declared as SET MIED 1000 UNIVERSITY
By Act of UGC Act, 1956

DEPARTMENT OF COMPUTER SCIENCE AND ENGINEERING

ACADEMIC YEAR 2023-2024

VIRTUAL REALITY

S.NO	NAME OF THE COURSE	REGNO	NAMELIST	YEAR/BRANCH
1.	VIRTUAL REALITY	2101CEI013	VARUN.M	IV CSE
2.		2101CEI602	VAIBARAMANATHAN.V	IV CSE
3.		2101CEI501	HARIPRASAD.R	IV CSE
4.		2101CEI615	SYED THAMEEM ASHIR Z	IV CSE
5.		2101CEI617	DINESH. L	IV CSE
6.		2101CEI620	HARIHARAN..K	IV CSE
7.		2101CEI014	MOHAMED HAJAM	IV CSE
8.		2101CEI015	SAHANA. S	IV CSE
9.		2101CEI016	MOHAMED ASIK.S	IV CSE
10.		2101CEI017	AJAY.K	IV CSE
11.		2101CEI018	HARIM	IV CSE
12.	2101CEI019	AKSHAY.A	IV CSE	

[Handwritten Signature]
Head of the Department

Department of Computer Science
and Engineering

Ponnaiyah Ramajayam Institute of
Science & Technology (PRIST)
(Institution Deemed to be University
Act 3 of the UGC Act, 1956)
KANNIYAKUMARI - 613 403, TAMIL NADU

[Handwritten Signature]
DEAN
Dean of Engineering and Tech.

Ponnaiyah Ramajayam Institute of
Science and Technology (PRIST)
Kanniyakumari, Tamil Nadu - 613 403

13.		2101CE1020	MOHAMMED ASIF.S	IV CSE
14.		2101CE1021	PRAKASH.V	IV CSE
15.		2101CE1022	HARSHA.B	IV CSE
16.		2101CE1023	MOHAMMED HISHAM.S	IV CSE
17.		2101CE1024	NISHAD	IV CSE
18.		2101CE1025	DIVYABHARATHI.R	IV CSE
19.		2101CE1026	AGALYA.S	IV CSE
20.		2101CE1027	VINOTH.M	IV CSE
21.		2101CE1028	VIHAN.J	IV CSE
22.		2101CE1029	PRATHIKSHA.S	IV CSE
23.		2101CE1030	PRAVEEN.M	IV CSE
24.		2101CE1031	ROSHIGA DEVI .R.N	IV CSE

[Handwritten Signature]

Head of the Department
Department of Computer Science
and Engineering
Periyar Ramajayam Institute of
Science & Technology (PRIST)
 Affiliated to the University
 of Jaffarpur - 613 403, Tamil Nadu

[Handwritten Signature]

DEAN
School of Engineering and Tech.
Periyar Ramajayam Institute of
Science and Technology (PRIST)
 Affiliated to the University
 of Jaffarpur - 613 403.



**PONNAIYAH RAMAJAYAM INSTITUTE OF
SCIENCE & TECHNOLOGY (PRIST)**

Declared as DEEMED TO BE UNIVERSITY
U/S 3 of UGC Act, 1956

DEPARTMENT OF COMPUTER SCIENCE AND ENGINEERING

ACADEMIC YEAR 2023-2024

TIME TABLE - VIRTUAL REALITY

MONTH	DATE	HOURS
DECEMBER	07.12.23	45HRS
	08.12.23	
	11.12.23	
	12.12.23	
	13.12.23	
	14.12.23	
	15.12.23	
	18.12.23	
	19.12.23	

Head of the Department
Department of Computer Science
and Engineering
Ponnaiyah Ramajayam Institute of
Science & Technology (PRIST)
(Insulation Deemed to be University
U/S 3 of the UGC Act, 1956,
THANJAVUR - 613 403, TAMIL NADU

DEAN
School of Engineering and Tech.
Ponnaiyah Ramajayam Institute of
Science and Technology (PRIST)
Deemed to be University
Thanjavur - 613 403



**PONNAIYAH RAMAJAYAM INSTITUTE OF
SCIENCE & TECHNOLOGY (PRIST)**

Declared as DEEMED TO BE UNIVERSITY
Under 3 of UGC Act, 1956

**SCHOOL OF ENGINEERING AND TECHNOLOGY
DEPARTMENT OF COMPUTER SCIENCE AND ENGINEERING**

CIRCULAR

SUB: ADD ON COURSE-Reg.,

It is informed that the department of computer science and engineering is planning to organized a certified course on Embedded Systems and IOT on 06.01.24 for the academic year 2023-2024 even semester. The detailed schedule will be given by the departments. Head of the departments are requested to inform their students about the certified course on Software testing Automation and motivate them to attend the course. HOD's are requested to nominate one faculty member to coordinate the same.

**Head of the Department,
Department of Computer Science
and Engineering
Ponnaiyah Ramajayam Institute of
Science & Technology,
(Institution Deemed to be University
under Section 3 of UGC Act, 1956)
Ponnaiyah Ramajayam Institute of Science & Technology**

**DEAN
School of Engineering and Tech.
Ponnaiyah Ramajayam Institute of
Science and Technology (PRIST)
Deemed to be University
Vallur, Tirujalur - 613 405**



**PONNAIYAH RAMAJAYAM INSTITUTE OF
SCIENCE & TECHNOLOGY (PRIST)**

Declared as DEEMED TO BE UNIVERSITY
U/s 3 of UGC Act, 1956

From

The HOD,
Department of CSE,
Prist University,
Vallam, Thanjavur.

To:

The DEAN,
Prist University,
Vallam, Thanjavur.

Respected Sir,

Sub:- Requesting Permission for conducting Add on Course – Reg.

I wish to bring to your kind information that the department of computer science and engineering has planned to conduct the following Add On course programme for the academic year 2023-24 even semester.

As the department is equipped with relevant lab facilities and enterprise in the same field, we are requesting the permission for the conduct of the same.

Duration: 45 Hrs.

Thanking You,

Yours Truly,

HOD/CSE

Head of the Department
Department of Computer Science
and Engineering
Ponnaiyah Ramajayam Institute of
Science & Technology (PRIST)
(Insulation Deemed to be University
U/s 3 of the UGC Act, 1956)
THANJAVUR - 613 403, TAMIL NADU.

DEAN
School of Engineering and Tech
Ponnaiyah Ramajayam Institute of
Science and Technology (PRIST)
Deemed to be University,
Vallam, Thanjavur - 613 403

EMBEDDED SYSTEMS AND IOT

UNIT I 8-BIT EMBEDDED PROCESSOR

8-Bit Microcontroller – Architecture – Instruction Set and Programming – Programming Parallel Ports – Timers and Serial Port – Interrupt Handling.

UNIT II EMBEDDED C PROGRAMMING

Memory And I/O Devices Interfacing – Programming Embedded Systems in C – Need For RTOS – Multiple Tasks and Processes – Context Switching – Priority Based Scheduling Policies.

UNIT III IOT AND ARDUINO PROGRAMMING

Introduction to the Concept of IoT Devices – IoT Devices Versus Computers – IoT Configurations – Basic Components – Introduction to Arduino – Types of Arduino– Arduino Toolchain – Arduino Programming Structure –Sketches – Introduction to Arduino Shields – Integration of Sensors and Actuators with Arduino.

UNIT IV IOT COMMUNICATION AND OPEN PLATFORMS

IoT Communication Models and APIs – IoT Communication Protocols – Bluetooth – WiFi – ZigBee– GPS – GSM modules – Open Platform (like Raspberry Pi) – Architecture -Connecting to the Cloud.

UNIT V APPLICATIONS DEVELOPMENT

Complete Design of Embedded Systems – Development of IoT Applications – Home Automation –Smart Agriculture – Smart Cities – Smart Healthcare.

Course outcomes:

- Understanding of Embedded Systems Architecture
- Design and Develop Embedded Systems Applications
- Proficiency in IoT Frameworks and Protocols
- to solve practical problems using embedded systems and cloud platforms in areas like smart homes, healthcare, and industrial IoT.



Head of the Department
Department of Computer Science
and Engineering
Ponniyiah Ramajayam Institute of
Science & Technology (P.R.I.S.T.)
(Institution Deemed to be University
Under Sec 3 of the UGC Act, 1956)
THANJAVUR - 613 403, Tamil Nadu

Head of the Institute
School of Engineering and Tech.
Ponniyiah Ramajayam Institute of
Science and Technology (P.R.I.S.T.)
Deemed to be University
Vallam, Thanjavur - 613 403

EMBEDDED SYSTEMS AND IOT

It is essential to know about the embedded devices while learning the IoT or building the projects on IoT. The embedded devices are the objects that build the unique computing system. These systems may or may not connect to the Internet.

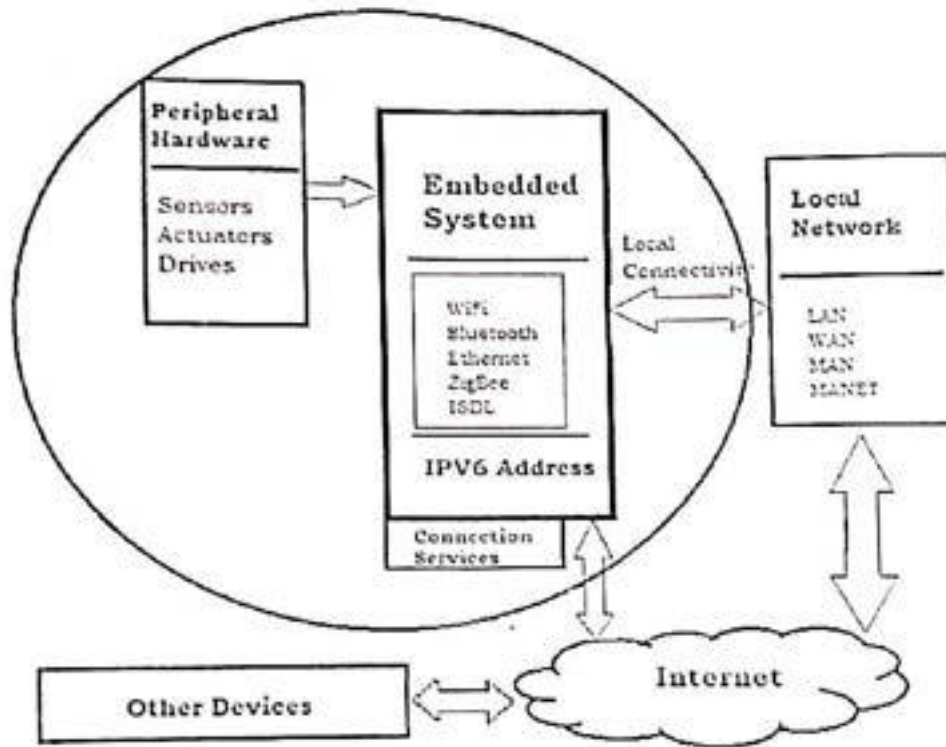
An embedded device system generally runs as a single application. However, these devices can connect through the internet connection, and able communicate through other network devices.



Internet of Things (IoT)

Embedded System Hardware

The embedded system can be of type microcontroller or type microprocessor. Both of these types contain an integrated circuit (IC).

The essential component of the embedded system is a RISC family microcontroller like Motorola 68HC11, PIC 16F84, Atmel 8051 and many more. The most important factor that differentiates these microcontrollers with the microprocessor like 8085 is their internal read and writable memory. The essential embedded device components and system architecture are specified below.

Head of the Department
 Department of Computer Science
 and Engineering
 Pennalyah Ramajayam Institute of
 Science & Technology (P.R.I.T.)
 (Insulation Deemed to be University
 's 3 of the UGC Act, 1956)
 THANJAVUR - 612 403, TAMIL NADU

DEAN
 School of Engineering and Tech,
 Pennalyah Ramajayam Institute of
 Science and Technology (P.R.I.T.)
 (Insulation to De University
 's 3 of the UGC Act, 1956)
 Thanjavur, Thanjavur - 612 403

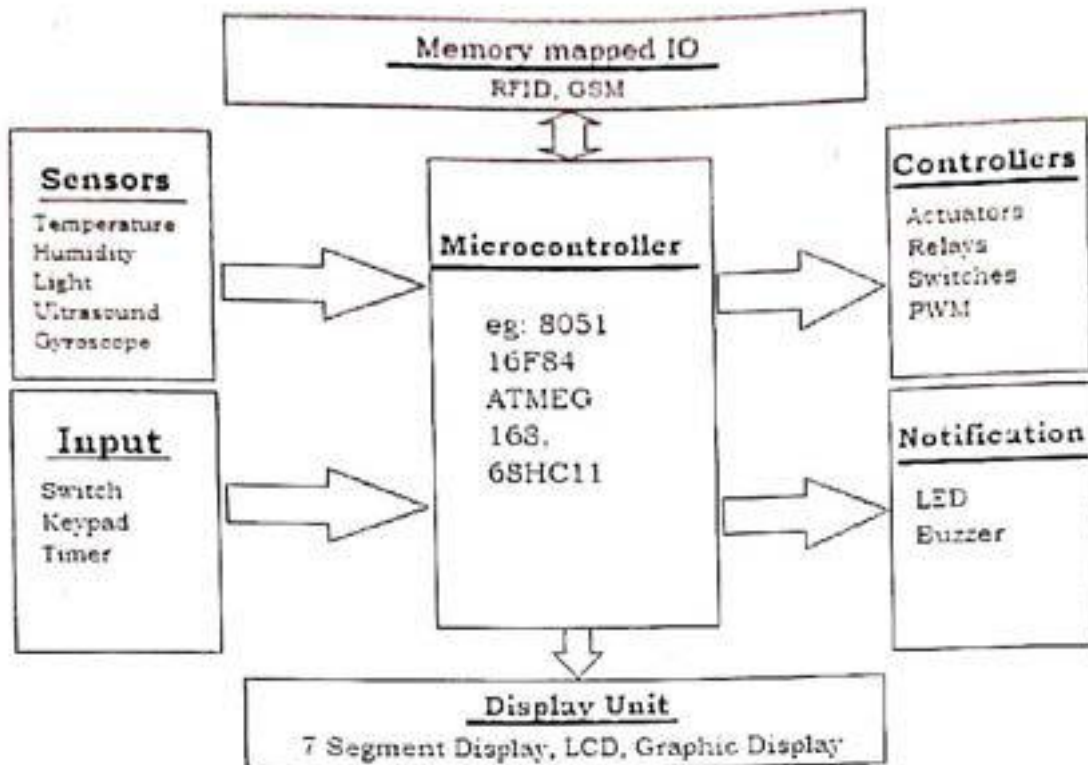

Fig: Basic Embedded System

Embedded System Software

The embedded system that uses the devices for the operating system is based on the language platform, mainly where the real-time operation would be performed. Manufacturers build embedded software in electronics, e.g., cars, telephones, modems, appliances, etc. The embedded system software can be as simple as lighting controls running using an 8-bit microcontroller. It can also be complicated software for missiles, process control systems, airplanes etc.

Application of Embedded System

- Home appliances
- Transportation
- Health care
- Business sector & offices
- Defense sector
- Aerospace
- Agricultural Sector

Characteristics of an Embedded System

- **Performs specific task:** Embedded systems perform some specific function or tasks.
- **Low Cost:** The price of an embedded system is not so expensive.
- **Time Specific:** It performs the tasks within a certain time frame.
- **Low Power:** Embedded Systems don't require much power to operate.
- **High Efficiency:** The efficiency level of embedded systems is so high.
- **Minimal User interface:** These systems require less user interface and are easy to use.

[Signature]
 Head of the Department
 Department of Computer Science
 and Engineering
 Ponnaiyah Ramajayam Institute of
 Science & Technology (PRIST)
 Government Deemed to be University
 15/3 of the UGC Act 1956
 THANJAVUR - 613 403, Tamil Nadu

[Signature]
 DEAN
 School of Engineering and Tech.
 Ponnaiyah Ramajayam Institute of
 Science and Technology (PRIST)
 Deemed to be University
 Vailam, Thanjavur - 613 403.

- **Less Human intervention:** Embedded systems require no human intervention or very less human intervention.
- **Highly Stable:** Embedded systems do not change frequently mostly fixed maintaining stability.
- **High Reliability:** Embedded systems are reliable they perform tasks consistently well.
- **Use microprocessors or microcontrollers:** Embedded systems use microprocessors or microcontrollers to design and use limited memory.
- **Manufacturable:** The majority of embedded systems are compact and affordable to manufacture. They are based on the size and low complexity of the hardware.

Embedded System Work

Embedded systems operate from the combination of hardware and software that focuses on certain operations. An embedded system at its heart has microcontroller or microprocessor hardware on which user writes the code in form of software for control of the system. Here is how it generally works:

- **Hardware Layer:** Some of the hardware elements that are incorporated in an embedded system include the sensor, actuator, memory, current I/O interfaces as well as power supply. These components are interfaced with the micro controller or micro processor, depending up on the input signals accepted.
- **Input/Output (I/O) Interfaces:** They to give the system input in form of data from sensors or inputs made by the users and the microcontroller processes the data received. The processed data is then utilized to coordinate the output devices such as displays, motors or communication modules.
- **Firmware:** Firmware which is integrated within a system's hardware comprises of certain instructions to accomplish a task. Such software is often used for real time processing and is tuned to work in the most optimal manner on the system hardware.
- **Processing:** Depending on the given software and the input data received from the system's inputs the microcontroller calculates the appropriate output or response and manages the system's components.
- **Real-time Operation:** Some of the most common systems are real time, this implies that they have the ability to process events or inputs at given time. This real time capability makes sure that the system accomplishes its intended function within stated time demands.



Head of the Department
Department of Computer Science
and Engineering
Pennalyah Ramajayam Institute of
Science & Technology (P.R.I.T.)
(Insulation Deemed to be University
As 3 of the UGC Act 1956)
THANJAVUR - 613 403, TAMIL NADU



DEAN
School of Engineering and Tech
Pennalyah Ramajayam Institute of
Science and Technology (P.R.I.T.)
Deemed to be University
Mylam, Thanjavur - 613 403.



**PONNAIYAH RAMAJAYAM INSTITUTE OF
SCIENCE & TECHNOLOGY (PRIST)**

Declared as DEEMED TO BE UNIVERSITY
Via 3 of UGC Act, 1956

DEPARTMENT OF COMPUTER SCIENCE AND ENGINEERING

**ACADEMIC YEAR 2023-2024
EMBEDDED SYSTEMS AND IOT**

S.NO	NAME OF THE COURSE	REGNO	NAME/IST	YEAR/BRANCH
1.	EMBEDDED SYSTEMS AND IOT	2001CE10101	NIRANJAN. I	IV CSE
2.		2001CE10102	BALAKRISHNAN .S	IV CSE
3.		2001CE10103	M. MANOTHAN	IV CSE
4.		2001CE10105	MUSTHAK HUSSAIN. J	IV CSE
5.		2001CE10106	THIYAGU. S	IV CSE
6.		2001CE10107	NAVEEN. R	IV CSE
7.		2001CE10108	ASHVANTHAN. J.P	IV CSE
8.		2001CE10109	THANGOOSHWARAN. R	IV CSE
9.		2001CE10110	NISHANTH. M.R	IV CSE
10.		2001CE10111	BHUVANESHI. K	IV CSE
11.		2001CE10112	MAHESHKUMAR	IV CSE
12.		2001CE10201	SUBIKSHA. S	IV CSE
13.		2001CE10202	RAJASHREE	IV CSE
14.		2004CE10101	DEV AKASH. S	IV CSE
15.		2004CE10102	MOHAMED ABDUL KALAM	IV CSE
16.		2004CE10104	M. HARIHARAN	IV CSE
17.		2101CE13101	APPAPPAN DEEPAK PETHAIAH. P.M	IV CSE
18.		2101CE13102	BALAMURUGAN. S	IV CSE
19.		2101CE13103	SANJAY KANNAH	IV CSE
20.		2101CE13104	PRASANNA NARAYANAN. S	IV CSE
21.		2101CE13105	SIVAKUMARAN.V	IV CSE
22.		2101CE13129	VIGNESHI.B	IV CSE
23.		1901CE1008	DEENADAYALAN.A	IV CSE
24.		2101CE1001	MOHAMED JAVID.M	IV CSE
25.		2101CE1002	SHAHEEN S	IV CSE

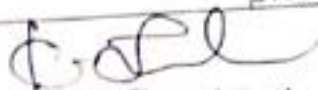
Head of the Department
Department of Computer Science
and Engineering
Ponnaiyah Ramajayam Institute of
Science & Technology (PRIST)
(Institution Deemed to be University
Via 3 of the UGC Act, 1956)
THANJAVUR - 613 003, TAMIL NADU

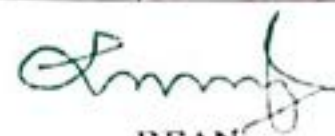
DEAN
School of Engineering and Tech.
Ponnaiyah Ramajayam Institute of
Science and Technology (PRIST)
Deemed to be University
Valiam, Thanjavur-613 003.

26.	210ICE1003	MOHAMED HISHAM.P	IV CSE
27.	210ICE1004	AJAY KUMAR.S	IV CSE
28.	210ICE1006	HARI HARAN B	IV CSE
29.	210ICE1007	APARNA.R	IV CSE
30.	210ICE1008	MOHAMED SIDDIK.S	IV CSE
31.	210ICE1009	ANJANA DEVIS	IV CSE
32.	210ICE1010	SHRI JANAH	IV CSE
33.	210ICE1011	GOVINDHA RAJ.J	IV CSE
34.	210ICE1012	KARTHIKEYAN.N	IV CSE
35.	210ICE1013	VARUN.M	IV CSE
36.	210ICE1602	VAIRARAMANATHAN.V	IV CSE
37.	210ICE1501	HARIPRASAD.R	IV CSE
38.	210ICE1615	SYED THAMEEM ASHIK Z	IV CSE
39.	210ICE1617	DINESH. L	IV CSE
40.	210ICE1620	HARIHARAN.. K	IV CSE
41.	210ICE1014	MOHAMED HAJA.M	IV CSE
42.	210ICE1015	SAHANA. S	IV CSE
43.	210ICE1016	MOHAMED ASIK.S	IV CSE
44.	210ICE1017	AJAY .K	IV CSE
45.	210ICE1018	HARI.M	IV CSE
46.	210ICE1019	AKSHAYA.A	IV CSE
47.	210ICE1020	MOHAMED ASIF.S	IV CSE
48.	210ICE1021	PRAKASH.V	IV CSE
49.	210ICE1022	HARSHA.B	IV CSE
50.	210ICE1023	MOHAMED HISHAM.S	IV CSE
51.	210ICE1024	NISHA.D	IV CSE
52.	210ICE1025	DIVYABHARATHI.R	IV CSE
53.	210ICE1026	AGALYA.S	IV CSE
54.	210ICE1027	VINOTILM	IV CSE
55.	210ICE1028	VIHAN.J	IV CSE
56.	210ICE1029	PRATHIKSHA.S	IV CSE
57.	210ICE1030	PRAVEEN.M	IV CSE
58.	210ICE1031	ROSHIGA DEVI .R.N	IV CSE

 Head of the Department
 Department of Computer Science
 and Engineering
 Ponnalyah Ramajayam Institute of
 Science & Technology (PRTI),
 (Insulation Deemed to be University
 U/A 3 of the UGC Act,1956)
 THANJAVUR - 615 403, TAMIL NADU.

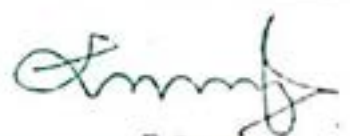
 DEAN
 School of Engineering and Tech
 Ponnalyah Ramajayam Institute of
 Science and Technology (PRTI)
 Deemed to be University
 Thanjavur, Tamil Nadu - 615 403



**PONNAIYAH RAMAJAYAM INSTITUTE OF
SCIENCE & TECHNOLOGY (PRIST)**
Declared as DEEMED TO BE UNIVERSITY
U/A 3 of UGC Act, 1956

DEPARTMENT OF COMPUTER SCIENCE AND ENGINEERING

ACADEMIC YEAR 2023-2024

TIME TABLE - EMBEDDED SYSTEMS AND IOT

MONTH	DATE	HOURS
JANUARY	09.01.24	45HRS
	10.01.24	
	11.01.24	
	12.01.24	
	19.01.24	
	22.01.24	
	23.01.24	
	24.01.24	
	25.01.24	

Head of the Department
Department of Computer Science
and Engineering
Ponnaiyah Ramajayam Institute of
Science & Technology (PRIST)
(Insulation Deemed to be University
U/A 3 of the UGC Act 1956)
THANJAVUR - 613 403, TAMIL NADU

DEAN
School of Engineering and Tech.
Ponnaiyah Ramajayam Institute of
Science and Technology (PRIST)
Deemed to be University
Vallam, Thanjavur - 613 403.



**PONNAIYAH RAMAJAYAM INSTITUTE OF
SCIENCE & TECHNOLOGY (PRIST)**

Declared as DEEMED TO BE UNIVERSITY
By S.O of UGC Act, 1956

**SCHOOL OF ENGINEERING AND TECHNOLOGY
DEPARTMENT OF COMPUTER SCIENCE AND ENGINEERING**

CIRCULAR

SUB: ADD ON COURSE-Reg.

It is informed that the department of computer science and engineering is planning to organized a certified course on Neural Networks on 04.03.24 for the academic year 2023-2024 even semester. The detailed schedule will be given by the departments. Head of the departments are requested to inform their students about the certified course on Neural Networks and motivate them to attend the course. HOD's are requested to nominate one faculty member to co-ordinate the same.

Head of the Department
Department of Computer Science
and Engineering
Ponnaiyah Ramajayam Institute of
Science & Technology (PRIST)
(Institution Deemed to be University
by S.O of UGC Act, 1956)
Pondicherry - 605 006

DEAN
School of Engineering and Tech.
Ponnaiyah Ramajayam Institute of
Science & Technology (PRIST)
(Institution Deemed to be University
by S.O of UGC Act, 1956)
Pondicherry - 605 006



**PONNAIYAH RAMAJAYAM INSTITUTE OF
SCIENCE & TECHNOLOGY (PRIST)**

Declared as DEEMED TO BE UNIVERSITY
U/s 3 of UGC Act, 1956

From

The HOD,
Department of CSE,
Prist University,
Vallam, Thanjavur.

To:

The DEAN,
Prist University,
Vallam, Thanjavur.

Respected Sir,

Sub:- Requesting Permission for conducting Add on Course – Reg.

I wish to bring to your kind information that the department of computer science and engineering has planned to conduct the following Add On course programme for the academic year 2023-24 even semester.

As the department is equipped with relevant lab facilities and enterprise in the same field, we are requesting the permission for the conduct of the same.

Duration: 45 Hrs.

Thanking You,

Yours Truly,
HOD/CSE

Head of the Department
Department of Computer Science
and Engineering
Ponnaiyah Ramajayam Institute of
Science & Technology (PRIST)
(Institution Deemed to be University
U/s 3 of the UGC Act, 1956)
THANJAVUR - 613 403, TAMIL NADU

DEAN
School of Engineering and Tech.
Ponnaiyah Ramajayam Institute of
Science and Technology (PRIST)
Deemed to be University
Vallam, Thanjavur - 613 403.

NEURAL NETWORKS

UNIT I FUNDAMENTALS OF NEURAL NETWORKS

Neuron, Nerve Structure and Synapse, Artificial Neuron and its Model, Activation Functions, Neural Network Architecture: Single Layer and Multilayer Feed Forward Networks, Recurrent Networks, Various Learning Techniques; Perception and Convergence Rule, Auto-Associative and Hetero-Associative Memory

UNIT II BACKPROPAGATION NETWORKS

Back Propagation Networks) Architecture: Perceptron Model, Solution, Single Layer Artificial Neural Network, Multilayer Perceptron Model; Back Propagation Learning Methods, Effect of Learning Rule Co - Efficient ;Back Propagation Algorithm, Factors Affecting Backpropagation Training, Applications

UNIT III COMPETITIVE NEURAL NETWORKS

Kohonen's Self Organizing Map - SOM Architecture, learning procedure - Application; Learning Vector Quantization - learning by LVQ; Adaptive Resonance Theory - Learning procedure - Applications.

UNIT VI PARAMETRIC MACHINE LEARNING

Logistic Regression: Classification and representation - Cost function - Gradient descent - Advanced optimization - Regularization - Solving the problems on overfitting. Perceptron -Neural Networks - Multi - class Classification - Backpropagation - Non-linearity with activation functions (Tanh, Sigmoid, Relu, PRelu) - Dropout as regularization

UNIT-V RADIAL NETWORKS

Radial Basis Function Networks, Pattern separability and interpolation, Regularization The or Regularization and RBF networks. RBF network design and training .Approximation properties of RBF.

Head of the Department
Department of Computer Science
and Engineering
Ponnaiyah Ramajayam Institute of
Science & Technology (PRIIST)
Birkeland Deemed to be University
(S.3 of the UGC Act 1956)
TIRUNELVELI - 613 403, Tamil Nadu.

DEAN
School of Engineering and Tech
Ponnaiyah Ramajayam Institute of
Science and Technology (PRIIST)
Deemed to be University
Vadakkulam, Tirunelveli - 613 423.

NEURAL NETWORKS

Neural networks extract identifying features from data, lacking pre-programmed understanding. Network components include neurons, connections, weights, biases, propagation functions, and a learning rule. Neurons receive inputs, governed by thresholds and activation functions. Connections involve weights and biases regulating information transfer. Learning, adjusting weights and biases, occurs in three stages: input computation, output generation, and iterative refinement enhancing the network's proficiency in diverse tasks.

These include:

1. The neural network is simulated by a new environment.
2. Then the free parameters of the neural network are changed as a result of this simulation.
3. The neural network then responds in a new way to the environment because of the changes in its free parameters.

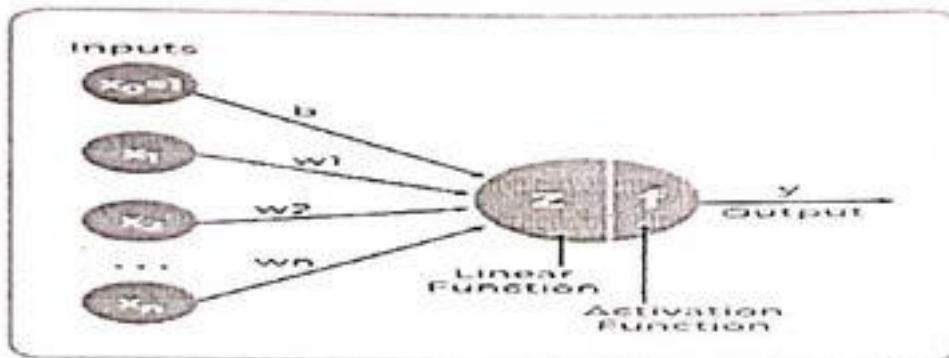

Importance of Neural Networks

The ability of neural networks to identify patterns, solve intricate puzzles, and adjust to changing surroundings is essential. Their capacity to learn from data has far-reaching effects, ranging from revolutionizing technology like natural language processing and self-driving automobiles to automating decision-making processes and increasing efficiency in numerous industries. The development of artificial intelligence is largely dependent on neural networks, which also drive innovation and influence the direction of technology.

Neural Networks work

Let's understand with an example of how a neural network works:

Consider a neural network for email classification. The input layer takes features like email content, sender information, and subject. These inputs, multiplied by adjusted weights, pass through hidden layers. The network, through training, learns to recognize patterns indicating whether an email is spam or not. The output layer, with a binary activation function, predicts whether the email is spam (1) or not (0). As the network iteratively refines its weights through backpropagation, it becomes adept at distinguishing between spam and legitimate emails, showcasing the practicality of neural networks in real-world applications like email filtering.

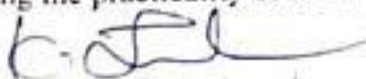
Head of the Department
Department of Computer Science
and Engineering
Ponnalyah Ramajayam Institute of
Science & Technology (PRIST)
(Insulation Deemed to be University
11a 3 of the UGC Act, 1956)
THANJAVUR - 613 403, TAMIL NADU.

DEAN
School of Engineering and Tech.
Ponnalyah Ramajayam Institute of
Science and Technology (PRIST)
Deemed to be University
Vailam, Thanjavur - 613 411

Working of a Neural Network

Neural networks are complex systems that mimic some features of the functioning of the human brain. It is composed of an input layer, one or more hidden layers, and an output layer made up of layers of artificial neurons that are coupled. The two stages of the basic process are called backpropagation and forward propagation.

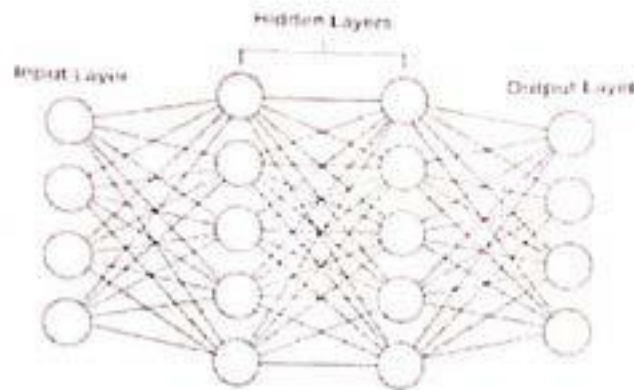

Types of Neural Networks

There are *seven* types of neural networks that can be used.

- **Feedforward Networks:** A feedforward neural network is a simple artificial neural network architecture in which data moves from input to output in a single direction.
- **Multilayer Perceptron (MLP):** MLP is a type of feedforward neural network with three or more layers, including an input layer, one or more hidden layers, and an output layer.
- **Convolutional Neural Network (CNN):** A Convolutional Neural Network (CNN) is a specialized artificial neural network designed for image processing.
- **Recurrent Neural Network (RNN):** An artificial neural network type intended for sequential data processing is called a Recurrent Neural Network (RNN).
- **Long Short-Term Memory (LSTM):** LSTM is a type of RNN that is designed to overcome the vanishing gradient problem in training RNNs.

Head of the Department
Department of Computer Science
and Engineering
Ponnaiyah Ramajayam Institute of
Science & Technology (PRIST)
(Institution Deemed to be University
As 3 of the UGC Act, 1956)
THANJAVUR - 613 402, TAMIL NADU.

DEAN
School of Engineering and Tech.
Ponnaiyah Ramajayam Institute of
Science and Technology (PRIST)
Deemed to be University
Vaiiam, Thanjavur - 613 403.



**PONNAIYAH RAMAJAYAM INSTITUTE OF
SCIENCE & TECHNOLOGY (PRIST)**

Declared as DEEMED TO BE UNIVERSITY
U/s 3 of UGC Act, 1956

DEPARTMENT OF COMPUTER SCIENCE AND ENGINEERING

ACADEMIC YEAR 2023-2024

NEURAL NETWORKS

S.NO	NAME OF THE COURSE	REGNO	NAMELIST	YEAR/BRANC H
1.	NEURAL NETWORKS	2101CE10201	R.KEERATHIANA	III CSE
2.		2101CE10202	S.ABINAYA	III CSE
3.		2101CE10101	S.AJAY KUMAR	III CSE
4.		2101CE10102	N.SURYA PRAKASH	III CSE
5.		2101CE10103	R.PRAVEEN	III CSE
6.		2101CE10104	S.ABISHAKE	III CSE
7.		2210CE13101	R.BALAJI	III CSE
8.		2201CE13102	A.DINESH KUMAR	III CSE
9.		2101CE13201	A.BAVA DHARANI	III CSE
10.		2101CE13202	P.GOWRI BHAVANA	III CSE
11.		2201CE13106	M.SUGANEESHWARAN	III CSE
12.		2201CE13109	U.RAGUL	III CSE
13.		2101CE13203	M.VISHVADHARSHINI	III CSE
14.		2101CE13204	G.SURIYA	III CSE
15.		2201CE13103	J.NOOR MOHAMED	III CSE
16.		2201CE13104	N.VIGNESH	III CSE
17.		2201CE13105	K.S.NAVEEN	III CSE
18.		2101CE13231	A.VIGNESH KUMAR	III CSE
19.		2201CE13107	VENKATESHWARAN	III CSE
20.		2201CE13110	G.PARVIN	III CSE
21.		2101CE13206	S.SUSHMA	III CSE

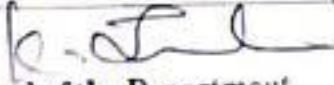
Head of the Department
Department of Computer Science
and Engineering
Ponnaiyah Ramajayam Institute of
Science & Technology (PRIST)
(Institution Deemed to be University
U/s 3 of the UGC Act, 1956)
THANJAVUR - 613 482, Tamil Nadu

DEAN
School of Engineering and Tech.
Ponnaiyah Ramajayam Institute of
Science and Technology (PRIST)
Deemed to be University
Vailam, Thanjavur-613

22.		2201CE13111	P.GOWTHAM	III CSE
23.		2201CE13112	R.SATHIS KANNAN	III CSE
24.		2201CE13113	RIYAS J	III CSE
25.		2201CE13114	SHEIK JI	III CSE
26.		2201CE13115	KANISHA R	III CSE
27.		2201CE13116	BIHARATHI D	III CSE
28.		2201CE13117	ARASAN J	III CSE
29.		2201CE13118	ARUN T	III CSE
30.		2201CE13119	AMIRTHEYA R	III CSE
31.		2201CE13120	BASITH S	III CSE
32.		2201CE13121	ALTHAF S	III CSE
33.		2201CE13122	KIRUTHIGA N	III CSE
34.		2201CE13123	WASIFUL HAQ A.H	III CSE
35.		2201CE13124	ASHOK BALU U	III CSE
36.		2201CE13125	ABDULLA SHIA M	III CSE
37.		2201CE13126	SHAKSHI S	III CSE
38.		2201CE13127	ATCHAYA K	III CSE
39.		2201CE13128	BRINDHA L	III CSE
40.		2201CE13129	SURYAPRAKASH K	III CSE
41.		2201CE13130	NAVEEN R	III CSE
42.		2101CE1014	MOHAMED HAJA M	III CSE
43.		2201CE13131	MURALIDHARAN V	III CSE
44.		2201CE13132	SARDAR I	III CSE
45.		2201CE13133	TAMILSELVI R	III CSE
46.		2201CE13134	MURUGAN S	III CSE
47.		2201CE13135	SARANYA T	III CSE
48.		2201CE13136	RAVICHANDRAN N	III CSE
49.		2201CE13137	ANSARI M	III CSE

 Head of the Department
 Department of Computer Science
 and Engineering
 Ponnaiyah Ramajayam Institute of
 Science & Technology (PRTIST)
 (Institution Deemed to be University
 by 3 of the UGC, New Delhi)
 Tirunelveli - 610 005, Tamil Nadu

 DEAN
 School of Engineering and Tech.
 Ponnaiyah Ramajayam Institute of
 Science and Technology (PRTIST)
 Tirunelveli - 610 005, Tamil Nadu

50.		2201CE13138	RAMALINGAM.V	III CSE
51.		2201CE13139	LATHA R	III CSE
52.		2201CE13140	AMIRTHALINGAM.N	III CSE
53.		2201CE13141	RAGHAVLN	III CSE
54.		2201CE13142	DHANESHI N	III CSE
55.		2201CE13143	SAMU K	III CSE
56.		2201CE13144	ASHOK KUMAR M	III CSE
57.		2201CE13145	SANTHIYA R	III CSE
58.		2201CE13146	LEGAN ALFANRO R	III CSE

 Head of the Department of
 Department of Computer Science
 and Engineering
 Ponnaiyah Ramajayam Institute of
 Science & Technology (PRIST)
 (Institution Deemed to be University
 under Sec 3 of the UGC Act, 1956)
 THANJAVUR - 613 403, TAMIL NADU

 DEAN
 School of Engineering and Tech.
 Ponnaiyah Ramajayam Institute of
 Science and Technology (PRIST)
 Deemed to be University
 Vaithehi, Thanjavur - 613 403.



**PONNAIYAH RAMAJAYAM INSTITUTE OF
SCIENCE & TECHNOLOGY (PRIST)**

DECLARED AS DEEMED TO BE UNIVERSITY
BY THE UGC ACT, 1956

**DEPARTMENT OF COMPUTER SCIENCE AND ENGINEERING
ACADEMIC YEAR 2023-2024
TIME TABLE - NEURAL NETWORKS**

MONTH	DATE	HOURS
MARCH	07.03.24	45 HRS
	08.03.24	
	11.03.24	
	12.03.24	
	13.03.24	
	14.03.24	
	15.03.24	
	18.03.24	
	19.03.24	

Head of the Department
Department of Computer Science
and Engineering
Ponnaiyah Ramajayam Institute of
Science & Technology (PRIST)
(Institution Deemed to be University
by the UGC Act, 1956)
TIRUJAVUR - 613 403, TAMIL NADU

DEAN
School of Engineering and Tech.
Ponnaiyah Ramajayam Institute of
Science and Technology (PRIST)
Deemed to be University
Vallam, Tirujavur - 613 403



**PONNAIYAH RAMAJAYAM INSTITUTE OF
SCIENCE & TECHNOLOGY (PRIST)**

Declared as DEEMED TO BE UNIVERSITY
U/s 3 of UGC Act, 1956

**SCHOOL OF ENGINEERING AND TECHNOLOGY
DEPARTMENT OF COMPUTER SCIENCE AND ENGINEERING**

CIRCULAR

SUB: ADD ON COURSE-Reg.,

It is informed that the department of computer science and engineering is planning to organized a certified course on Artificial Intelligence and Machine Learning on 12.04.24 for the academic year 2023-2024 even semester. The detailed schedule will be given by the departments. Head of the departments are requested to inform their students about the certified course on Deep Learning motivate them to attend the course. HOD's are requested to nominate one faculty member to co-ordinate the same.

**Head of the Department
Department of Computer Science
and Engineering
Ponnaiyah Ramajayam Institute of
Science & Technology
(Institution Deemed to be University
U/s 3 of the UGC Act, 1956
Pondicherry - 605 006, Tamil Nadu)**

**DEAN
School of Engineering and Tech,
Ponnaiyah Ramajayam Institute of
Science and Technology (PRIST)
Deemed to be University
Valluvar, Ponnaiyah Ramajayam, Pondicherry**



**PONNAIYAH RAMAJAYAM INSTITUTE OF
SCIENCE & TECHNOLOGY (PRIST)**

Declared as DEEMED TO BE UNIVERSITY
U/s 3 of UGE Act, 1956

From

The HOD,
Department of CSE,
Prist University,
Vallam, Thanjavur.

To:

The DEAN,
Prist University,
Vallam, Thanjavur.

Respected Sir,

Sub:- Requesting Permission for conducting Add on Course – Reg.

I wish to bring to your kind information that the department of computer science and engineering has planned to conduct the following Add On course programme for the academic year 2023-24 even semester.

As the department is equipped with relevant lab facilities and enterprise in the same field, we are requesting the permission for the conduct of the same.

Duration: 45 Hrs.

Thanking You,

Yours Truly,
HOD/CSE

Head of the Department
Department of Computer Science
and Engineering
Ponnaiyah Ramajayam Institute of
Science & Technology
Vallam, Thanjavur - 612 018

DEAN
School of Engineering and Tech.
Ponnaiyah Ramajayam Institute of
Science and Technology (PRIST)
Deemed to be University
Vallam, Thanjavur - 612 018

ARTIFICIAL INTELLIGENCE AND MACHINE LEARNING

UNIT I INTELLIGENT AGENTS

Introduction to AI – Agents and Environments – concept of rationality – nature of environments – structure of agents. Problem solving agents – search algorithms – uninformed search strategies.

UNIT II PROBLEM SOLVING

Heuristic search strategies – heuristic functions. Local search and optimization problems – local search in continuous space – search with non-deterministic actions – search in partially observable environments – online search agents and unknown environments

UNIT III GAME PLAYING AND CSP

Game theory – optimal decisions in games – alpha-beta search – monte-carlo tree search – stochastic games – partially observable games. Constraint satisfaction problems – constraint propagation – backtracking search for CSP – local search for CSP – structure of CSP.

UNIT IV INTRODUCTION TO MACHINE LEARNING

Review of Linear Algebra for machine learning; Introduction and motivation for machine learning; Examples of machine learning applications, Hypothesis spaces, Inductive bias, Generalization, Bias variance trade-off.

UNIT V SUPERVISED LEARNING

Linear Regression Models: Least squares, single & multiple variables, Bayesian linear regression, gradient descent, Linear Classification Models: Naive Bayes, Maximum margin classifier – Support vector machine, Decision Tree, Random Forests.

COURSE OUTCOMES:

- Explain intelligent agent frameworks
- Apply problem solving techniques
- Apply game playing and CSP techniques.
- Explain the basic concepts of machine learning.
- Construct supervised learning models.



Head of the Department
Department of Computer Science
and Engineering
Pennalyah Ramajayam Institute of
Science & Technology (PRIST)
(Institution Deemed to be University
Under Section 3 of the UGC Act, 1956)
THANJAVUR - 613 403, TAMIL NADU

DEAN
School of Engineering and Tech
Pennalyah Ramajayam Institute of
Science and Technology (PRIST)
Vellore, Tamil Nadu, India

ARTIFICIAL INTELLIGENCE AND MACHINE LEARNING

Artificial intelligence (AI) is a broad category that includes machine learning (ML) as a subset. AI is the ability of computers to mimic human thought and perform tasks, while ML is a set of techniques that teach computers how to perform specific tasks.

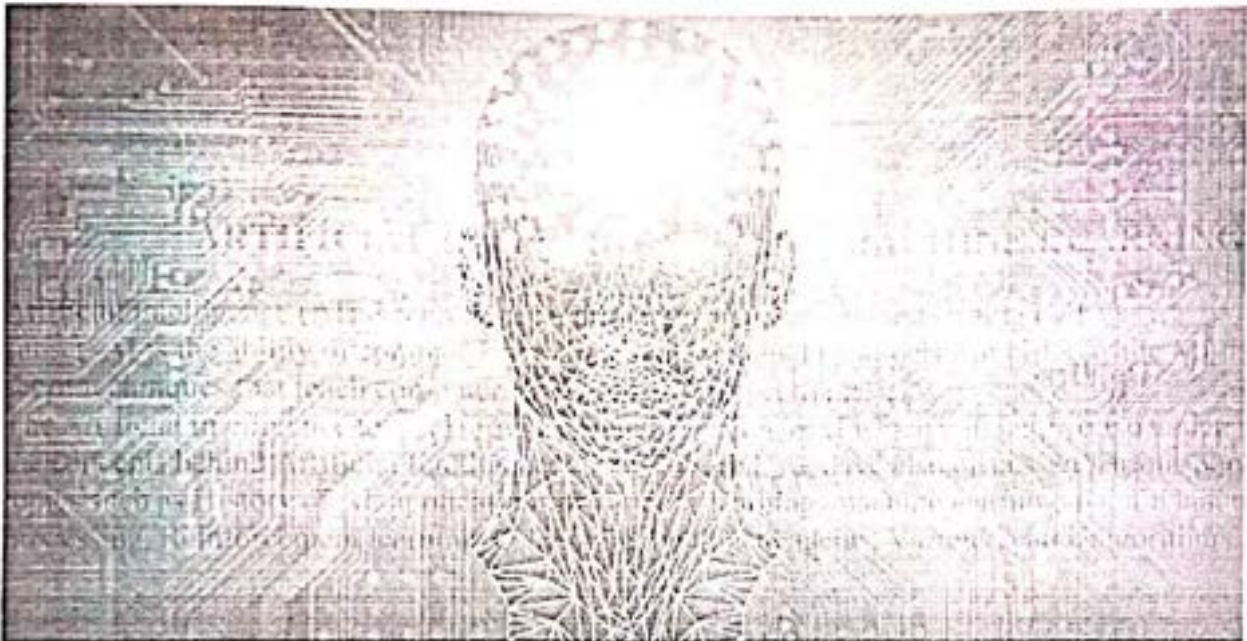
The Artificial Intelligence tutorial provides an introduction to AI which will help you to understand the concepts behind Artificial Intelligence. In this tutorial, we have also discussed various popular topics such as History of AI, applications of AI, deep learning, machine learning, natural language processing, Reinforcement learning, Q-learning, Intelligent agents, Various search algorithms, etc.



Our AI tutorial is prepared from an elementary level so you can easily understand the complete tutorial from basic concepts to the high-level concepts.

What is Artificial Intelligence (AI)?

In today's world, technology is growing very fast, and we are getting in touch with different new technologies day by day.

some main advantages of Artificial Intelligence:

- **High Accuracy with less errors:** AI machines or systems are prone to less errors and high accuracy as it takes decisions as per pre-experience or information.
- **High-Speed:** AI systems can be of very high-speed and fast-decision making, because of that AI systems can beat a chess champion in the Chess game.
- **High reliability:** AI machines are highly reliable and can perform the same action multiple times with high accuracy.
- **Useful for risky areas:** AI machines can be helpful in situations such as defusing a bomb, exploring the ocean floor, where to employ a human can be risky.

Head of the Department
Department of Computer Science
and Engineering
Ponnaiyah Ramalayam Institute of
Science & Technology (P-R-I-S-T)
(Institution Deemed to be University
No. 3 of the UGC Act, 1956)
TIRUVANANTHAPURAM - 610 402, TAMILNADU.

DEAN
School of Engineering and Tech.
Ponnaiyah Ramalayam Institute of
Science and Technology
Deemed to be U
Vadakkal, Thanjavur

- o **Digital Assistant:** AI can be very useful to provide digital assistant to the users such as AI technology is currently used by various E-commerce websites to show the products as per customer requirement.
- o **Useful as a public utility:** AI can be very useful for public utilities such as a self-driving car which can make our journey safer and hassle-free, facial recognition for security purpose, Natural language processing to communicate with the human in human-language, etc.

Classification of Machine Learning

Machine learning implementations are classified into four major categories, depending on the nature of the learning “signal” or “response” available to a learning system which are as follows:

1. Supervised learning:

Supervised learning is the machine learning task of learning a function that maps an input to an output based on example input-output pairs. The given data is labeled. Both *classification* and *regression* problems are supervised learning problems.

2. Unsupervised learning:

Unsupervised learning is a type of machine learning algorithm used to draw inferences from datasets consisting of input data without labeled responses. In unsupervised learning algorithms, classification or categorization is not included in the observations. Example: Consider the following data regarding patients entering a clinic. The data consists of the gender and age of the patients.

3. Reinforcement learning:

Reinforcement learning is the problem of getting an agent to act in the world so as to maximize its rewards.

A learner is not told what actions to take as in most forms of machine learning but instead must discover which actions yield the most reward by trying them.

4. Semi-supervised learning:

Where an incomplete training signal is given: a training set with some (often many) of the target outputs missing. There is a special case of this principle known as Transduction where the entire set of problem instances is known at learning time, except that part of the targets are missing. Semi-supervised learning is an approach to machine learning that combines small labeled data with a large amount of unlabeled data during training. Semi-supervised learning falls between unsupervised learning and supervised learning.

- **Neural networks**

Neural networks are a series of algorithms that are modeled after the human brain. They are used to train computers to mimic human reasoning. Deep learning is a type of neural network that has more than three layers, including the input and output layers.

- **Real-world applications**

AI and ML are used in many real-world applications, including health care, advanced robotics, and network security:

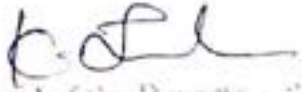
 Head of the Department of
 Computer Science
 and Engineering
 Ponnalyah Ramapayam Institute of
 Science & Technology (P.R.I.S.T)
 (Institution Deemed to be University
 by the UGC Act, 1956)
 Ponnalyah - 612 400, Tirunelveli.

 DEAN
 School of Engineering and Tech.
 Ponnalyah Ramapayam Institute of
 Science and Technology (PRIST)
 Deemed to be University
 Vallam, Tirunelveli - 612 400

- Health care: AI and ML can be used to scan x-rays for cancerous growths, develop personalized treatment plans, and allocate hospital resources.
- Advanced robotics: AI and ML can be used to develop intelligent machines that can perform complex tasks.
- Network security: AI and ML can be used to assess network threats and improve security measures.

AI and ML connected

While AI and ML are not quite the same thing, they are closely connected. The simplest way to understand how AI and ML relate to each other is:

- AI is the broader concept of enabling a machine or system to sense, reason, act, or adapt like a human
- ML is an application of AI that allows machines to extract knowledge from data and learn from it autonomously

One helpful way to remember the difference between machine learning and artificial intelligence is to imagine them as umbrella categories. Artificial intelligence is the overarching term that covers a wide variety of specific approaches and algorithms. Machine learning sits under that umbrella, but so do other major subfields, such as deep learning, robotics, expert systems, and natural language processing.



Head of the Department
 Department of Computer Science
 and Engineering
 Pennaiyah Ramajayam Institute of
 Science & Technology (PRTI)
 (Institution Deemed to be University
 's 3 of the UGC Act, 1956)
 TIRUNELVELI - 611 303, TAMIL NADU



DEAN
 School of Engineering and Tech.
 Pennaiyah Ramajayam Institute of
 Science and Technology (PRTI)
 Deemed to be University
 Valparai, Tirunelveli - 611 303



PONNAIYAH RAMAJAYAM INSTITUTE OF
SCIENCE & TECHNOLOGY (PRIST)

Declared as DEEMED TO BE UNIVERSITY
by U of DC, Act, 1956

DEPARTMENT OF COMPUTER SCIENCE AND ENGINEERING

ACADEMIC YEAR 2023-2024

ARTIFICIAL INTELLIGENCE AND MACHINE LEARNING

S.NO	NAME OF THE COURSE	REGNO	NAME/LIST	YEAR/BRANC II
1.	ARTIFICIAL INTELLIGENCE AND MACHINE LEARNING	220ICE10101	ABHISHEK. C	II CSE
2.		220ICE10102	MANIMARAN. K	II CSE
3.		220ICE10103	PREMKUMAR. S	II CSE
4.		220ICE10104	YASAR ARAFATH. R	II CSE
5.		220ICE10105	AADITHYAN. K.N	II CSE
6.		220ICE10108	SRINIVASAN. T	II CSE
7.		220ICE10109	MADHESH. A	II CSE
8.		220ICE10110	AATHIL. R	II CSE
9.		220ICE10111	VEERAMANIKANDAN. T	II CSE
10.		220ICE10112	YADAV SHIVAPERUMAL APPAUMANI	II CSE
11.		220ICE10113	SABARISH. C	II CSE
12.		220ICE10114	KABILAN. S	II CSE
13.		220ICE10115	SAKTHISHIVARAN. A	II CSE
14.		220ICE10116	MOHAMED ASIF	II CSE
15.		220ICE10201	RAKSHAMBIGAL. N	II CSE
16.		220ICE10203	ANUSHKA	II CSE
17.		220ICE10203	MUTHUKUMARAN. M	II CSE
18.		230ICE13102	VENKATESH. G	II CSE
19.		230ICE13103	THANUSHU. M	II CSE
20.		220ICE10204	RITHIKA. V	II CSE
21.		220ICE10117	MOHAMED IMTHIYAZA	II CSE

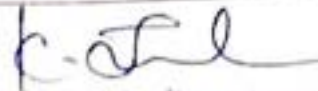
Head of the Department
Department of Computer Science
and Engineering
Ponnaiyah Ramajayam Institute of
Science & Technology (PRIST)
Declared as Deemed to be University
by U of DC, Act, 1956
TIRUNELVELI - 625 019

DEAN
School of Engineering and Tech.
Ponnaiyah Ramajayam Institute of
Science and Technology
Declared to be an
Autonomous Institution

22.		2201CE10118	BALAJI V	II CSE
23.		2201CE10119	DIANA A S S	II CSE
24.		2201CE10120	MOHAMED OMAR M.F	II CSE
25.		2201CE10121	SANJAY.M	II CSE
26.		2201CE10122	ABISHEK J	II CSE
27.		2201CE10123	AMARNATH G	II CSE
28.		2201CE10124	ANUSHIYA R	II CSE
29.		2201CE10125	AROKIYA MEJELLA B	II CSE
30.		2201CE10126	ASWIN S K	II CSE
31.		2201CE10127	AZHAGU RAJAN T	II CSE
32.		2201CE10128	BALAJI S	II CSE
33.		2201CE10129	DEVIKA S	II CSE
34.		2201CE10130	DHARSHANA M A	II CSE
35.		2201CE10131	GANESAN M	II CSE
36.		2201CE10132	GUNA SOORIYA G S	II CSE
37.		2201CE10133	HARIHARAN S	II CSE
38.		2201CE10134	KAVIN P	II CSE
39.		2201CE10135	KISHORE G	II CSE
40.		2201CE10136	LAKSHMI PRIYA S K	II CSE
41.		2201CE10137	MANOJA T	II CSE
42.		2201CE10138	MARIYAM S	II CSE
43.		2201CE10139	MATHINA BEGUM M	II CSE
44.		2201CE10140	MOHAMED YOUSUF IMRAN A	II CSE
45.		2201CE10141	NANDHINI MIR	II CSE
46.		2201CE10142	NAVEEN M	II CSE
47.		2201CE10143	NIRANJANI M	II CSE



Head of the Department
Department of Computer Science
and Engineering
Ponnamiah Ramaswamy Institute
Science & Technology
Pondicherry
605 006



DEAN
School of Engineering and Tech.
Ponnamiah Ramaswamy Institute
Science and Technology
Deemed to be University
Vallam, Thanjavur

48		2201CE10144	PRABAKARAN M	HCSE
49		2201CE10145	RINATHILHAN M	HCSE
50		2201CE10146	RISHIVARSAN S	HCSE
51		2201CE10147	RITHIKA R	HCSE
52		2201CE10148	RITHI PRIYANKA B	HCSE
53		2201CE10149	SATHI NAZLEM G	HCSE
54		2201CE10150	SAKTHI MONESH S	HCSE
55		2201CE10151	SAKTHI VIGNESH K	HCSE
56		2201CE10152	SANJAI J	HCSE
57		2201CE10153	SANTHOSH G	HCSE
58		2201CE10154	SHANMUGAPRIYA S	HCSE

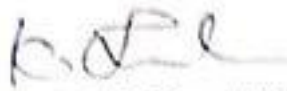
Head of the Department
Department of Computer Science
and Engineering
Ponnalyah Ramajayam Institute of
Science & Technology (Deemed to be University)
(Institution Deemed to be University
78 3 of the UGC Act, 1956)
THANJAVUR - 613 403, TAMIL NADU

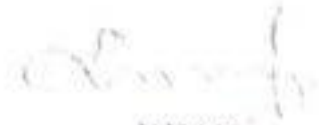
DEAN
School of Engineering and Tech.
Ponnalyah Ramajayam Institute of
Science and Technology (Deemed to be University)
Thanjavur - 613 403



**PONNAIYAH RAMAJAYAM INSTITUTE OF
SCIENCE & TECHNOLOGY (PRIST)**

Declared as DEEMED TO BE UNIVERSITY
U/s 3 of UGC Act, 1956

**DEPARTMENT OF COMPUTER SCIENCE AND ENGINEERING
ACADEMIC YEAR 2023-2024
TIME TABLE – ARTIFICIAL INTELLIGENCE AND MACHINE LEARNING**

MONTH	DATE	HOURS
APRIL	16.04.24	45HRS
	17.04.24	
	18.04.24	
	19.04.24	
	22.04.24	
	23.04.24	
	24.04.24	
	25.04.24	
	26.04.24	

Head of the Department
Department of Computer Science
and Engineering
Ponnaiyah Ramajayam Institute of
Science & Technology (PRIST)
(Institution Deemed to be University
U/s 3 of the UGC Act, 1956)
THANJAVUR - 613 403, TAMIL NADU

DEAN
School of Engineering and Tech.
Ponnaiyah Ramajayam Institute of
Science and Technology (PRIST)
(Deemed to be University)
Thanjavur, Tamil Nadu - 613 403



**PONNAIYAI RAMAJAYAM INSTITUTE OF
SCIENCE & TECHNOLOGY (PRIST)**

Declared as Affiliated to the UNIVERSITY
of J. J. J. REG. Act. 1950

DEPARTMENT OF COMPUTER SCIENCE AND ENGINEERING

DIGITAL MARKETING

ATTENDANCE (2023-24) - ODD

S.NO	REG NO	NAME/LIST	JULY										
			13.07.23	14.07.23	17.07.23	18.07.23	19.07.23	20.07.23	21.07.23	24.07.23	25.07.23		
1.	2001CE10101	NIRANJAN, J	/	/	/	/	/	/	/	/	/	/	/
2.	2001CE10102	BALAKRISHNAN, S	/	/	/	/	/	/	/	/	/	/	/
3.	2001CE10103	M. MANOTHAN	/	/	/	/	/	/	/	/	/	/	/
4.	2001CE10105	MUSTHAK HUSSAIN, J	/	/	/	/	/	/	/	/	/	/	/
5.	2001CE10106	THIYAGU, S	/	/	/	/	/	/	/	/	/	/	/
6.	2001CE10107	NAVEEN, R	/	/	/	/	/	/	/	/	/	/	/
7.	2001CE10108	ASHVANTHAN, J.P	/	/	/	/	/	/	/	/	/	/	/
8.	2001CE10109	THANOOSHWARAN, R	/	/	/	/	/	/	/	/	/	/	/
9.	2001CE10110	NISHANTH, M.R	/	/	/	/	/	/	/	/	/	/	/
10.	2001CE10111	BIJUVANESH, K	/	/	/	/	/	/	/	/	/	/	/
11.	2001CE10112	MAHESHKUMAR	/	/	/	/	/	/	/	/	/	/	/
12.	2001CE10201	SUBRISHA, S	/	/	/	/	/	/	/	/	/	/	/
13.	2001CE10202	RAJASHREE	/	/	a	/	/	/	/	/	/	/	/
14.	2003CE10101	D.V AKASH, S	/	/	/	/	/	/	/	/	/	/	a
15.	2004CE10102	MOHAMMED ABDUL KALAM	/	/	/	/	/	/	/	/	/	/	/
16.	2004CE10104	M. HARHARAN	/	/	/	/	/	/	/	/	/	/	/
		AVYAPPA DEEPAK	/	/	/	/	/	/	/	/	/	/	/
		DEAN	/	/	/	/	/	/	/	/	/	/	/

Department of Computer Science
and Engineering

Ponnaiyaa Ramajayam Institute of
Science & Technology (PRIST)

University of J. J. J. Reg. Act. 1950
Vandalur, Chennai - 600 030

School of Engineering and Tech.

Ponnaiyaa Ramajayam Institute of
Science and Technology (PRIST)

University of J. J. J. Reg. Act. 1950
Vandalur, Chennai - 600 030

18.	P101CE13102	PETIAHAL, P.M	/	/	/	/	/	/	/	/	/	/	/	/	/	/	/	/	/
19.	P101CE13103	BALAMURUGAN, S SANJAY KANNALI	/	/	/	/	/	/	/	/	/	/	/	/	/	/	/	/	/
20.	P101CE13104	PRASANNA NARAYANAN, S	/	/	/	/	/	/	/	/	/	/	/	/	/	/	/	/	/
21.	P101CE13105	SIVAKUMARAN, V	/	/	/	/	/	/	/	/	/	/	/	/	/	/	/	/	/
22.	P101CE13129	MGNESILB	/	/	/	/	/	/	/	/	/	/	/	/	/	/	/	/	/
23.	P101CE1008	DEENADAYALANA	/	/	/	/	/	/	/	/	/	/	/	/	/	/	/	/	/
24.	P101CE1001	MOHAMMED JAVID, M	/	/	/	/	/	/	/	/	/	/	/	/	/	/	/	/	/
25.	P101CE1002	SHAHEEN, S	/	/	/	/	/	/	/	/	/	/	/	/	/	/	/	/	/
26.	P101CE1003	MOHAMMED HISHAM, P	/	/	/	/	/	/	/	/	/	/	/	/	/	/	/	/	/
27.	P101CE1004	AJAY KUMAR, S	/	/	/	/	/	/	/	/	/	/	/	/	/	/	/	/	/
28.	P101CE1006	HARIHARAN, B	/	/	/	/	/	/	/	/	/	/	/	/	/	/	/	/	/
29.	P101CE1007	APARNA, R	/	/	/	/	/	/	/	/	/	/	/	/	/	/	/	/	/
30.	P101CE1008	MOHAMMED SIDDIK, S	/	/	/	/	/	/	/	/	/	/	/	/	/	/	/	/	/
31.	P101CE1009	ANJANA DEVI, S	/	/	/	/	/	/	/	/	/	/	/	/	/	/	/	/	/
32.	P101CE1010	SIRI JANNATH	/	/	/	/	/	/	/	/	/	/	/	/	/	/	/	/	/
33.	P101CE1011	GOVINDHA RAJ	/	/	/	/	/	/	/	/	/	/	/	/	/	/	/	/	/
34.	P101CE1012	KARTHIKEYAN, N	/	/	/	/	/	/	/	/	/	/	/	/	/	/	/	/	/
35.	P101CE1013	NARIN, M	/	/	/	/	/	/	/	/	/	/	/	/	/	/	/	/	/
36.	P101CE1602	VAIKARAMANATHIAN, V	/	/	/	/	/	/	/	/	/	/	/	/	/	/	/	/	/
37.	P101CE1501	HARIPRASAD, R	/	/	/	/	/	/	/	/	/	/	/	/	/	/	/	/	/
38.	P101CE1615	SYED TIAMEEM ASHIK, Z	/	/	/	/	/	/	/	/	/	/	/	/	/	/	/	/	/
39.	P101CE1617	DINESH, L	/	/	/	/	/	/	/	/	/	/	/	/	/	/	/	/	/
40.	P101CE1620	HARIHARAN, K	/	/	/	/	/	/	/	/	/	/	/	/	/	/	/	/	/
41.	P101CE1014	MOHAMMED HAJAM	/	/	/	/	/	/	/	/	/	/	/	/	/	/	/	/	/
42.	P101CE1015	SAHAYNA, S	/	/	/	/	/	/	/	/	/	/	/	/	/	/	/	/	/
43.	P101CE1016	MOHAMMED ASIK, S	/	/	/	/	/	/	/	/	/	/	/	/	/	/	/	/	/
44.	P101CE1017	AJAY, K	/	/	/	/	/	/	/	/	/	/	/	/	/	/	/	/	/
45.	P101CE1018	HARIM	/	/	/	/	/	/	/	/	/	/	/	/	/	/	/	/	/
46.	P101CE1019	AKSHAYNA	/	/	/	/	/	/	/	/	/	/	/	/	/	/	/	/	/
47.	P101CE1020	MOHAMMED ASIF, S	/	/	/	/	/	/	/	/	/	/	/	/	/	/	/	/	/

Head of the Department

Department of Applied Sciences and Engineering

DEAN

School of Engineering and Tech

Ponnalayah Ramajayam Institute of

Science & Technology (Private)

Tranjavur - 613 403, Tamil Nadu

Contact No: 017 4221414

Website: www.ponraj.ac.in

Established under the UGC Act, 1956

Tranjavur - 613 403, Tamil Nadu

48.	P101CE1021	PRAKASH V	/	/	/	/	/	/	/	/	/	/	/	/	/	/	/	/
49.	P101CE1022	HARSHA B	/	/	/	/	/	/	/	/	/	/	/	/	/	/	/	/
50.	P101CE1023	MOHAMMED HISHAM.S	/	/	/	/	/	/	/	/	/	/	/	/	/	/	/	/
51.	P101CE1024	NISHAD	/	/	a	/	/	/	/	/	/	/	/	/	/	/	/	/
52.	P101CE1025	DIVYABHARATHIL R	/	/	/	/	/	/	/	/	/	/	/	/	/	/	/	/
53.	P101CE1026	AGALYAS	/	/	/	/	/	/	/	/	/	/	/	/	/	/	/	/
54.	P101CE1027	VINOTH.M	/	/	/	/	/	/	/	/	/	/	/	/	/	/	/	/
55.	P101CE1028	VIHAN J	/	/	/	/	/	/	/	/	/	/	/	/	/	/	/	/
56.	P101CE1029	PRATHIKSHA.S	/	/	a	/	/	/	/	/	/	/	/	/	/	/	/	/
57.	P101CE1030	PRAVEEN.M	/	/	/	/	/	/	/	/	/	/	/	/	/	/	/	/
58.	P101CE1031	ROSHIGA DEVI .R.N	/	/	/	/	/	/	/	/	/	/	/	/	/	/	/	/
		Staff Signature	/	/	/	/	/	/	/	/	/	/	/	/	/	/	/	/

 Head of the Department
 Department of Computer Science
 and Engineering
 Ponnaiyah Ramajayam Institute of
 Science & Technology (Periyar
 Government Deemed to be University)
 Thanjavur - 613 403, Tamil Nadu

 DEAN
 School of Engineering and Tech.
 Ponnaiyah Ramajayam Institute of
 Science and Technology (Periyar
 Government Deemed to be University)
 Vailam, Thanjavur - 613 403.



**PONNAIYAH RAMAJAYAM INSTITUTE OF
SCIENCE & TECHNOLOGY (PRIST)**

Declared as DEEMED TO BE UNIVERSITY
By 3 of UGC Act, 1956

**DEPARTMENT OF COMPUTER SCIENCE AND ENGINEERING
DATA SCIENCE**

ATTENDANCE (2023-24) - ODD

S.NO	REG NO	NAME/LIST	SEPTEMBER											
			12.09.23	13.09.23	14.09.23	15.09.23	18.09.23	19.09.23	20.09.23	21.09.23	22.09.23			
1.	P101CE10201	R.KEERATHANA	/	/	/	/	/	/	/	/	/	/	/	/
2.	P101CE10202	SABINAYA	/	/	/	/	/	/	/	/	/	/	/	/
3.	P101CE10101	SAIJAY KUMAR	/	/	/	/	/	/	/	/	/	/	/	/
4.	P101CE10102	N.SURYA PRAKASH	/	/	/	/	/	/	/	/	/	/	/	/
5.	P101CE10103	R.PRAVEEN	/	/	/	/	/	/	/	/	/	/	/	/
6.	P101CE10104	S.ABISHAKE	/	/	/	/	/	/	/	/	a	/	/	/
7.	P210CE13101	R.BALAJI	/	/	/	/	/	/	/	/	/	/	/	/
8.	P201CE13102	A.DINESH KUMAR	/	/	/	/	/	/	/	/	/	/	/	/
9.	P101CE13201	A.BAVA DHARANI	/	/	/	/	/	/	/	/	/	/	/	/
10.	P101CE13202	P.GOWRI BHAVANA	/	/	/	/	/	/	/	/	/	/	/	/
11.	P201CE13106	M.SUGANESHWARAN	/	/	/	/	/	/	/	/	/	/	/	/
12.	P201CE13109	U.RAGUL	/	/	a	/	/	/	/	/	/	/	/	/
13.	P101CE13203	M.VISHVADHARSHINI	/	/	/	/	/	/	/	/	/	/	/	/
14.	P101CE13204	G.SURIYA	/	/	/	/	/	/	/	/	/	/	/	/
15.	P201CE13103	J.NOOR MOHAMED	/	/	/	/	/	/	/	/	/	/	/	/
Head of the Department's 104			N.VIGNESH	/	/	/	/	/	/	/	/	/	/	/

DEAN

[Signature]

Department of Computer Science
and Engineering
Ponnaiyah Ramajayam Institute of
Science & Technology (PRIST)
Deemed to be University
3 of the UGC Act, 1956
Valluvar - 613 403, Tamil Nadu

School of Engineering and Tech
Ponnaiyah Ramajayam Institute of
Science and Technology (PRIST)
Deemed to be University
Valluvar, Thanjavur - 613 403.

17.	P20ICEI3105	K.S.NAVEEN	/	/	/	/	/	/	/	/	/	/	/	/	/	/	/	/
18.	P10ICEI3231	A.VIGNESH KUMAR	/	/	/	/	/	/	/	/	/	/	/	/	/	/	/	/
19.	P20ICEI3107	VENKATESHWARAN	/	/	/	/	/	/	/	/	/	/	/	/	/	/	/	/
20.	P20ICEI3110	G.PARVIN	/	/	/	/	/	/	/	/	/	/	/	/	/	/	/	/
21.	P10ICEI3206	S.SUSHMA	/	/	/	/	/	/	/	/	/	/	/	/	/	/	/	/
22.	P20ICEI3111	P.GOWTHAM	/	/	/	/	/	/	/	/	/	/	/	/	/	/	/	/
23.	P20ICEI3112	R.SATHIS KANNAN	/	/	/	/	/	/	/	/	/	/	/	/	/	/	/	/
24.	P20ICEI3113	RIYAS J	/	/	/	/	/	/	/	/	/	/	/	/	/	/	/	/
		Staff Signature	M. for	M. for	M. for	M. for	M. for	M. for	M. for	M. for	M. for	M. for	M. for	M. for	M. for	M. for	M. for	M. for

[Handwritten Signature]

Head of the Department
 Department of Computer Science
 and Engineering
 Ponnalyah Ramalayam Institute of
 Science & Technology (P.R.I.S.T.)
 (Institution Deemed to be University
 under Section 3 of the UGC Act, 1956)
 THANDAVUR - 613 405, TAMIL NADU

[Handwritten Signature]

DEAN
 School of Engineering and Tech
 Ponnalyah Ramalayam Institute of
 Science and Technology (P.R.I.S.T.)
 Deemed to be University
 Valavan, Thiruvavur - 613 403.



**PONNAIYAH RAMAJAYAM INSTITUTE OF
SCIENCE & TECHNOLOGY (PRIST)**

Declared as DEEMED TO BE UNIVERSITY
U/S 3 of UGC Act, 1956

DEPARTMENT OF COMPUTER SCIENCE AND ENGINEERING

ETHICAL HACKING

ATTENDANCE (2023-24) - ODD

S.NO	REG NO	NAME/LIST	NOVEMBER											
			07.11.23	08.11.23	09.11.23	10.11.23	13.11.23	14.11.23	15.11.23	16.11.23	17.11.23			
1.	2201CE13114	SHEIK J.H	/	/	/	/	/	/	/	/	/	/	/	/
2.	2201CE13115	KANISHA R	/	/	/	/	/	/	/	/	/	/	/	/
3.	2201CE13116	BIHARATHI D	/	/	/	/	/	/	/	/	/	/	/	/
4.	2201CE13117	ARASAN J	/	/	/	/	/	/	/	/	/	/	/	/
5.	2201CE13118	ARUN T	/	/	/	/	/	/	/	/	/	/	/	/
6.	2201CE13119	AMRTHIYYA R	/	/	/	/	/	/	/	/	/	/	/	/
7.	2201CE13120	BASITH S	/	/	/	/	/	/	/	/	/	/	/	/
8.	2201CE13121	ALTHAF S	/	/	/	/	/	/	/	/	/	/	/	/
9.	2201CE13122	KIRUTHIGA N	/	/	/	/	/	/	/	/	/	/	/	/
10.	2201CE13123	WASIFUL HAQ A.H	/	/	/	/	/	/	/	/	/	/	/	/
11.	2201CE13124	ASHIKOR BALU J	/	/	/	/	/	/	/	/	/	/	/	/
12.	2201CE13125	ABDULLA SHAM M	/	/	/	/	/	/	/	/	/	/	/	/
13.	2201CE13126	SHAKSHI S	/	/	/	/	/	/	/	/	/	/	/	/
14.	2201CE13127	ATCIYAAYA R	/	/	/	/	/	/	/	/	/	/	/	/
15.	2201CE13128	BRINDHA J.	/	/	/	/	/	/	/	/	/	/	/	/
	2201CE13129	SURYAPRAKASHK	/	/	/	/	/	/	/	/	/	/	/	/
	2201CE13130	NAVEEN R	/	/	/	/	/	/	/	/	/	/	/	/

(Signature)
Head of the Department

(Signature)
Head of Engineering and IT

Ponnaiyah Ramajayam Institute of
Science and Technology (PRIST)
Vandalur, Thiruvallur - 611 003

Department of Computer Science
and Engineering
Ponnaiyah Ramajayam Institute of
Science & Technology (PRIST)
Vandalur, Thiruvallur - 611 003



**PONNAIYAH RAMAJAYAM INSTITUTE OF
SCIENCE & TECHNOLOGY (PRIST)**
Incorporated as DEFERRED TO BE UNIVERSITY
UNDER ACT OF UGC Act, 1956

**DEPARTMENT OF COMPUTER SCIENCE AND ENGINEERING
VIRTUAL REALITY**

ATTENDANCE (2023-24) - ODD

S.NO	REG NO	NAME/ELIST	DECEMBER											
			07.12.24	08.12.24	11.12.24	12.12.24	13.12.24	14.12.24	15.12.24	18.12.24	19.12.24			
1.	210ICE1013	VARUN.M	/	/	/	/	/	/	/	/	/	/	/	/
2.	210ICE1602	VAIRARAMANATHAN.V	/	/	/	/	/	/	/	/	/	/	/	/
3.	210ICE1501	HARIPRASADR	/	/	/	/	/	/	/	/	/	/	/	/
4.	210ICE1615	SYED THAMEEM ASHIK Z	/	/	/	/	/	/	/	/	/	/	/	/
5.	210ICE1617	DINESH.L	/	/	a	/	/	/	/	/	/	/	/	/
6.	210ICE1620	HARIHARAN..K	/	/	/	/	/	/	/	/	/	/	/	/
7.	210ICE1014	MOHAMED HAJAM.M	/	/	/	/	/	/	/	/	/	/	/	/
8.	210ICE1015	SAHANA.S	/	/	/	/	/	/	/	/	/	/	/	/
9.	210ICE1016	MOHAMED ASIK.S	/	/	/	/	/	/	/	/	/	/	/	/
10.	210ICE1017	MAV..K	/	/	/	/	/	/	/	/	/	/	/	/
11.	210ICE1018	HARIM	/	/	/	/	/	/	/	/	/	/	/	/
12.	210ICE1019	AKSHAY.A.A	/	/	/	/	/	/	/	/	/	/	/	/
13.	210ICE1020	MOHAMED ASIF.S	/	/	/	/	/	/	/	/	/	/	/	/
	210ICE1021	PRAKASH.V	/	/	/	/	/	/	/	/	/	/	/	/
	210ICE1022	HARSHAB	/	/	/	/	/	/	/	/	/	/	/	/

Handwritten signature

School of Engineering and Tech.

Department of Computer Science
and Engineering
Ponnaiyah Ramajayam Institute of
Science & Technology (PRIST)
(Institution Deemed to be University)
53 of the UGC Act, 1956
PONDICHERRY - 605 003, TAMIL NADU

Ponnaiyah Ramajayam Institute of
Science and Technology (PRIST)
Incorporated To Be University
Under Act of UGC Act, 1956

16.	E10ICE1023	MOHAMED HISHAM.S	/	/	/	/	/	/	/	/	/	/	/	/	/	/	/	/
17.	E10ICE1024	NISHA.D	/	/	/	/	/	/	/	/	/	/	/	/	/	/	/	/
18.	E10ICE1025	DIVYABHARATHI.R	/	/	/	/	/	/	/	/	/	/	/	/	/	/	/	/
19.	E10ICE1026	AGALYA.S	/	/	/	/	/	/	/	/	/	/	/	/	/	/	/	/
20.	E10ICE1027	VINOTH.M	/	/	/	/	/	/	/	/	/	/	/	/	/	/	/	/
21.	E10ICE1028	VIHAN.J	/	/	/	/	/	/	/	/	/	/	/	/	/	/	/	/
22.	E10ICE1029	PRATHIKSHA.S	/	/	/	/	/	/	/	/	/	/	/	/	/	/	/	/
23.	E10ICE1030	PRAVEEN.M	/	/	/	/	/	/	/	/	/	/	/	/	/	/	/	/
24.	E10ICE1031	ROSHIGA DEVI .R.N	/	/	/	/	/	/	/	/	/	/	/	/	/	/	/	/
		Staff Signature	WSP	WSP	WSP	WSP	WSP	WSP	WSP	WSP	WSP	WSP	WSP	WSP	WSP	WSP	WSP	WSP

[Handwritten Signature]

Head of the Department
 Department of Computer Science
 and Engineering
 Ponnaiyah Ramalayah Institute of
 Science & Technology (PRIST)
 (Institution Deemed to be University)
 23 of 08, UCC, Sec-11
 Vallam, Thanjavur - 613 001

[Handwritten Signature]

DEAN
 School of Engineering and Tech
 Ponnaiyah Ramalayah Institute of
 Science and Technology (PRIST)
 Deemed to be University
 Vallam, Thanjavur - 613 001.

16.	P10ICE1023	MOHAMED HISHAM.S	✓	✓	✓	✓	✓	✓	✓	✓	✓	✓	✓	✓	✓	✓	✓	✓	✓
17.	P10ICE1024	NISHA.D	✓	✓	✓	✓	✓	✓	✓	✓	✓	✓	✓	✓	✓	✓	✓	✓	✓
18.	P10ICE1025	DIVYABHARATHI.R	✓	✓	✓	✓	✓	✓	✓	✓	✓	✓	✓	✓	✓	✓	✓	✓	✓
19.	P10ICE1026	AGALYAS	✓	✓	✓	✓	✓	✓	✓	✓	✓	✓	✓	✓	✓	✓	✓	✓	✓
20.	P10ICE1027	VINOTH.M	✓	✓	✓	✓	✓	✓	✓	✓	✓	✓	✓	✓	✓	✓	✓	✓	✓
21.	P10ICE1028	VIHAN.J	✓	✓	✓	✓	✓	✓	✓	✓	✓	✓	✓	✓	✓	✓	✓	✓	✓
22.	P10ICE1029	PRATHIKSHA.S	✓	✓	✓	✓	✓	✓	✓	✓	✓	✓	✓	✓	✓	✓	✓	✓	✓
23.	P10ICE1030	PRAVEEN.M	✓	✓	✓	✓	✓	✓	✓	✓	✓	✓	✓	✓	✓	✓	✓	✓	✓
24.	P10ICE1031	ROSHIGA DEVI .R.N	✓	✓	✓	✓	✓	✓	✓	✓	✓	✓	✓	✓	✓	✓	✓	✓	✓
		Staff Signature	<i>[Signature]</i>	<i>[Signature]</i>	<i>[Signature]</i>	<i>[Signature]</i>	<i>[Signature]</i>	<i>[Signature]</i>	<i>[Signature]</i>	<i>[Signature]</i>	<i>[Signature]</i>	<i>[Signature]</i>	<i>[Signature]</i>	<i>[Signature]</i>	<i>[Signature]</i>	<i>[Signature]</i>	<i>[Signature]</i>	<i>[Signature]</i>	<i>[Signature]</i>

[Handwritten Signature]

Head of the Department
 Department of Computer Science
 and Engineering
 Ponnalyah Ramalayam Institute of
 Science & Technology (P.R.I.S.T.)
 (Autonomous Deemed to be University)
 23 and 24B, UCE, Mettupalayam,
 Erode District - 613 502, Tamil Nadu

[Handwritten Signature]

DEAN
 School of Engineering and Tech.
 Ponnalyah Ramalayam Institute of
 Science and Technology (P.R.I.S.T.)
 Deemed to be University
 Vairam, Thanjavur - 613 403.



**PONNAIYAH RAMAJAYAM INSTITUTE OF
SCIENCE & TECHNOLOGY (PRIST)**

Declared as DEEMED TO BE UNIVERSITY
U/S 3 of UGC Act, 1956

**DEPARTMENT OF COMPUTER SCIENCE AND ENGINEERING
EMBEDDED SYSTEMS AND IOT
ATTENDANCE (2023-24) - EVEN**

S.NO	REG NO	NAME/LIST	JANUARY										
			09.01.24	10.01.24	11.01.24	12.01.24	19.01.24	22.01.24	23.01.24	24.01.24	25.01.24		
1.	2001CEI0101	NIRANJAN, I	/	/	/	/	/	/	/	/	/	/	/
2.	2001CEI0102	BALAKRISHNAN, S	/	/	/	/	/	/	/	/	/	/	/
3.	2001CEI0103	M. MANOTHAN	/	/	/	/	/	/	/	/	/	/	/
4.	2001CEI0105	MUSTHAK HUSSAIN, J	/	/	/	/	/	/	/	/	/	/	/
5.	2001CEI0106	THIYAGU, S	/	/	/	/	/	/	/	/	/	/	/
6.	2001CEI0107	NAVEEN, R	/	/	/	/	/	/	/	/	/	/	/
7.	2001CEI0108	ASHVANTHAN, J.P	/	/	/	/	/	a	/	/	/	/	/
8.	2001CEI0109	THANOOJIWARAN, R	/	/	/	/	/	/	/	/	/	/	/
9.	2001CEI0110	NISHANTH, M.R	/	/	/	/	/	/	/	/	/	/	/
10.	2001CEI0111	BHUVANESH, K	/	/	/	/	/	/	/	/	/	/	/
11.	2001CEI0112	MAHESHKUMAR	/	/	/	/	/	/	/	/	/	/	/
12.	2001CEI0201	SUBIKSHA, S	/	/	a	/	/	/	/	/	/	/	/
13.	2001CEI0202	RAJASREE	/	/	/	/	/	/	/	/	/	/	/
	2004CEI0101	DEV AKASH, S	/	/	/	/	/	/	/	/	/	/	/
	2004CEI0102	MOLIAMMED ABDUL KALAM	/	/	/	/	/	/	/	/	/	/	/

[Signature]
Head of the Department

DEAN

[Signature]

Department of Computer Science
and Engineering
Ponnaiyah Ramajayam Institute of
Science & Technology (PRIST)
(Institution Deemed to be University)
U/S 3 of the UGC Act, 1956

School of Engineering and Tech.
Ponnaiyah Ramajayam Institute of
Science and Technology (PRIST)
Deemed to be University
Vandalur, Chennai-600 042

44.	210ICE1017	AIJAY.K	/	/	/	/	/	/	/	/	/	/	/	/	/	/	/
45.	210ICE1018	ILARIM	/	/	/	/	/	/	/	/	/	/	/	/	/	/	/
46.	210ICE1019	AKSHIYA.A	/	/	/	/	/	/	/	/	/	/	/	/	/	/	/
47.	210ICE1020	MOHAMED ASIF.S	/	/	/	/	/	/	/	/	/	/	/	/	/	/	/
48.	210ICE1021	PRAKASH.V	/	/	/	/	/	/	/	/	/	/	/	/	/	/	/
49.	210ICE1022	HARSHAB	/	/	/	/	/	/	/	/	/	/	/	/	/	/	/
50.	210ICE1023	MOHAMED HISHAM.S	/	/	/	/	/	/	/	/	/	/	/	/	/	/	/
51.	210ICE1024	NISSA.D	/	/	/	/	/	/	/	/	/	/	/	/	/	/	/
52.	210ICE1025	DIVYABHARATH.R	/	/	/	/	/	/	/	/	/	/	/	/	/	/	/
53.	210ICE1026	AGALYA.S	/	/	/	/	/	/	/	/	/	/	/	/	/	/	/
54.	210ICE1027	VINOTH.M	/	/	/	/	/	/	/	/	/	/	/	/	/	/	/
55.	210ICE1028	VIHAN.J	/	/	/	/	/	/	/	/	/	/	/	/	/	/	/
56.	210ICE1029	PRATHIKSHA.S	/	/	/	/	/	/	/	/	/	/	/	/	/	/	/
57.	210ICE1030	PRAVEEN.M	/	/	/	/	/	/	/	/	/	/	/	/	/	/	/
58.	210ICE1031	ROSHIGA DEVI.R.N	/	/	/	/	/	/	/	/	/	/	/	/	/	/	/
		Staff Signature	NS	NS	NS	NS	NS	NS	NS	NS	NS	NS	NS	NS	NS	NS	NS

[Handwritten Signature]

Head of the Department
 Department of Computer Science
 and Engineering
 Ponnalyah Ramalayam Institute of
 Science & Technology
 (Autonomous) Deemed to be University
 P.O. No. 14/2 of the first part of the
 Government Order No. 134/2005, Tamil Nadu

[Handwritten Signature]

DEAN
 School of Engineering and Tech.
 Ponnalyah Ramalayam Institute of
 Science and Technology (Autonomous)
 Deemed to be University
 P.O. No. 14/2 of the first part of the
 Government Order No. 134/2005



**PONNAIYAH RAMAJAYAM INSTITUTE OF
SCIENCE & TECHNOLOGY (PRIST)**
Declared as DEEMED TO BE UNIVERSITY
U/S 3 of UGC Act, 1956

**DEPARTMENT OF COMPUTER SCIENCE AND ENGINEERING
NEURAL NETWORKS**

ATTENDANCE (2023-24) - EVEN

S.NO	REG NO	NAME/LIST	MARCH								
			07.03.24	08.03.24	11.03.24	12.03.24	13.03.24	14.03.24	15.03.24	18.03.24	19.03.24
1.	D10ICE10201	R.KEERATHANA	/	/	/	/	/	/	/	/	/
2.	D10ICE10202	S.SABINAAYA	/	/	/	/	/	/	/	/	/
3.	D10ICE10101	S.SAIY KUMAR	/	/	/	/	/	/	/	/	/
4.	D10ICE10102	N.SURRYA PRAKASHI	/	/	/	/	/	/	/	/	/
5.	D10ICE10103	R.PRAVEEN	/	/	/	/	/	/	/	/	/
6.	D10ICE10104	S.SABISHAKE	/	/	/	a	/	/	/	/	/
7.	D210CE13101	R.BALAJI	/	/	/	/	/	/	/	/	/
8.	D20ICE13102	A.DINESH KUMAR	/	/	/	/	/	/	/	/	/
9.	D10ICE13201	A.BAVA DHARANI	/	/	/	/	/	/	/	/	/
10.	D10ICE13202	P.GOWRI BHAVANA	/	/	/	/	/	/	/	a	/
11.	D20ICE13106	M.SUGANESHWARAN	/	/	/	/	/	/	/	/	/
12.	D20ICE13109	U.RAGUL	/	/	/	/	/	/	/	/	/
13.	D10ICE13203	M.VISHVADHARSHINI	/	/	/	/	/	/	/	/	/
	D10ICE13204	G.SURIYA	/	/	/	/	/	/	/	/	/
		J.NOOR MOHAMMED	/	/	/	/	/	/	/	/	/

[Handwritten Signature]
Head of Department

[Handwritten Signature]
DEAN

Faculty of Computer Science
and Engineering
Ponnaiyah Ramajayam Institute of
Science & Technology (PRIST)
Deemed to be University
U/S 3 of UGC Act, 1956

School of Engineering and Tech
Ponnaiyah Ramajayam Institute of
Science and Technology (PRIST)
Deemed to be University
Vairath, Thanjavur - 613 303.

45.	P201CE13133	TAMILSELVI R	/	/	/	/	/	/	/	/	/	/	/	/	/	/	/
46.	P201CE13134	MURUGAN,S	/	/	/	/	/	/	/	/	/	/	/	/	/	/	/
47.	P201CE13135	SARANYA T	/	/	/	/	a	/	/	/	/	/	/	/	/	/	/
48.	P201CE13136	RAVICHANDRAN,N	/	/	/	/	/	/	/	/	/	/	/	/	/	/	/
49.	P201CE13137	ANSARIM	/	/	/	/	/	/	/	/	/	/	/	/	/	/	/
50.	P201CE13138	RAMALINGAM,V	/	/	/	/	/	/	/	/	/	/	/	/	/	/	/
51.	P201CE13139	LATHA R	/	/	/	/	/	/	/	/	/	/	/	/	/	/	/
52.	P201CE13140	AMIRTHALINGAM,N	/	/	/	/	/	/	/	/	/	/	/	/	/	/	/
53.	P201CE13141	RAGHAVIN	/	/	/	/	/	/	/	/	/	/	/	/	/	/	/
54.	P201CE13142	DHANESHI N	/	/	/	/	/	/	/	/	/	/	/	/	/	/	/
55.	P201CE13143	SAMU K	/	/	/	/	/	/	/	/	/	/	/	/	/	/	/
56.	P201CE13144	ASHOK KUMAR M	/	/	/	/	/	/	/	/	/	/	/	/	/	/	a
57.	P201CE13145	SANTHIYA R	/	/	/	/	/	/	/	/	/	/	/	/	/	/	/
58.	P201CE13146	LEGAN ALFANRO R	/	/	/	/	/	/	/	/	/	/	/	/	/	/	/
Staff Signature			/	/	/	/	/	/	/	/	/	/	/	/	/	/	/

Head of the Department
Department of Computer Science
and Engineering
Annalavah Ramalayam Institute of
Science & Technology (PRIST)
 (Autonomous Department of the University of
Thiruvalluvar - 613 403, Thiruvalluvar

DEAN
School of Engineering and Tech.
Annalavah Ramalayam Institute of
Science and Technology (PRIST)
 Deemed to be University
 Vallam, Thiruvalluvar - 613 403.



**PONNAIYAH RAMAJAYAM INSTITUTE OF
SCIENCE & TECHNOLOGY (PRIST)**

Declared as MEMBR TO BE UNIVERSITY
U.S.A of REG Act, 1956

**DEPARTMENT OF COMPUTER SCIENCE AND ENGINEERING
ARTIFICIAL INTELLIGENCE AND MACHINE LEARNING**

ATTENDANCE (2023-24) - EVEN

S.NO	REG NO	NAME/LIST	APRIL											
			16.04.24	17.04.24	18.04.24	19.04.24	22.04.24	23.04.24	24.04.24	25.04.24	26.04.24			
1.	2201CE10101	ABISHEK. C	/	/	/	/	/	/	/	/	/	/	/	
2.	2201CE10102	MANIMARAN. K	/	/	/	/	/	/	/	/	/	/	/	
3.	2201CE10103	PREMKUMAR. S	/	/	/	/	/	/	/	/	/	/	/	
4.	2201CE10104	YASAR ARAFATH. R	/	/	a	/	/	/	/	/	/	/	/	
5.	2201CE10105	AADHITHYAN. K.N	/	/	/	/	/	/	/	/	/	/	/	
6.	2201CE10108	SRINIVASAN. T	/	/	/	/	/	/	a	/	/	/	/	
7.	2201CE10109	MADHESH. A	/	/	/	/	/	/	/	/	/	/	/	
8.	2201CE10110	VATHI. R	/	/	/	/	/	/	/	/	/	/	/	
9.	2201CE10111	NEERAMANIKANDAN. T	/	/	/	/	/	/	/	/	a	/	/	
10.	2201CE10112	VADAV SIVAPENDUMAL APPAL. VIANI	/	/	/	/	/	/	/	/	/	/	/	
11.	2201CE10113	SABARISH. C	/	a	/	/	/	/	/	/	/	/	/	
12.	2201CE10114	MAHILAN. S	/	/	/	/	/	/	/	/	/	/	/	
	2201CE10115	SAKTHISHWARAN. A	/	/	/	/	/	/	/	/	/	/	/	

(Signature)
Department
of Computer Science
and Engineering

(Signature)
DEAN

Ponnaiyah Ramajayam Institute of
Science & Technology (PRIST)
Embraced to be University
of the State of Tamil Nadu

School of Engineering and Tech.
Ponnaiyah Ramajayam Institute of
Science and Technology (PRIST)
Embraced to be University
Vandalur, Thanjavur - 613 013.

43.	2201CE10139	MATHINA BEGUM M	/	/	/	/	/	/	/	/	/	/	/	/	/	/	/	/	/	/
44.	2201CE10140	MOHAMED YOUSUF IMRAN A	/	/	/	/	/	/	/	/	/	/	/	/	/	/	/	/	/	/
45.	2201CE10141	NANDHINI MR	/	/	/	/	/	/	/	/	/	/	/	/	/	/	/	/	/	a
46.	2201CE10142	NAVEEN M	/	/	/	/	/	/	/	/	/	/	/	/	/	/	/	/	/	/
47.	2201CE10143	NIRANJANI M	/	/	/	/	/	/	/	/	/	/	/	/	/	/	/	/	/	/
48.	2201CE10144	PRABAKARAN M	/	/	/	/	/	/	/	/	/	/	/	/	/	/	/	/	/	/
49.	2201CE10145	RINATHITHAN M	/	/	/	/	/	/	/	/	/	/	/	/	/	/	/	/	/	/
50.	2201CE10146	RISHIVARSAN S	/	/	/	/	/	/	/	/	/	/	/	/	/	/	/	/	/	/
51.	2201CE10147	RITHIKA R	/	/	/	/	/	/	/	/	/	/	/	/	/	/	/	/	/	/
52.	2201CE10148	RITHI PRIYANKA B	/	/	/	/	/	/	/	/	/	/	/	/	/	/	/	/	/	/
53.	2201CE10149	SAFITH NAZEEM G	/	/	/	/	/	/	/	/	/	/	/	/	/	/	/	/	/	/
54.	2201CE10150	SAKTHI MONESH S	/	/	/	/	/	/	/	/	/	/	/	/	/	/	/	/	/	/
55.	2201CE10151	SAKTHIVIGNESH K	/	/	/	/	/	/	/	/	/	/	/	/	/	/	/	/	/	/
56.	2201CE10152	SANJAI J	/	/	/	/	/	/	/	/	/	/	/	/	/	/	/	/	/	/
57.	2201CE10153	SANTHOSH G	/	/	/	/	/	/	/	/	/	/	/	/	/	/	/	/	/	/
58.	2201CE10154	SHANMUGAPRIYA S	/	/	/	/	/	/	/	/	/	/	/	/	/	/	/	/	/	/
		Staff Signature	/																	

Dr. A. Arif Babar
 Department of Computer Science
 and Engineering
 Ponnalyah Ramajayan Institute of
 Science & Technology
 (Insulation Deemed to be University)
 Puzosai, Thandiyur - 613 403, Tamil Nadu

Dr. Arif Babar
 DEAN
 School of Engineering and Tech.
 Ponnalyah Ramajayan Institute of
 Science and Technology (Deemed to be University)
 Puzosai, Thandiyur - 613 403.



**PONNAIYAH RAMAJAYAM INSTITUTE OF
SCIENCE & TECHNOLOGY (PRIST)**

Declared as DEEMED TO BE UNIVERSITY
Uts 3 of UGC Act, 1956

**SCHOOL OF ENGINEERING AND TECHNOLOGY
DEPARTMENT OF COMPUTER SCIENCE AND ENGINEERING**

CIRCULAR

SUB: ADD ON COURSE-Reg.,

It is informed that the department of computer science and engineering is planning to organized a certified course on Digital Marketing on 11.07.23 for the academic year 2023-2024 odd semester. The detailed schedule will be given by the departments. Head of the departments are requested to inform their students about the certified course on Digital Marketing and motivate them to attend the course. HOD's are requested to nominate one faculty member to co-ordinate the same.

**Head of the Department
Department of Computer Science
and Engineering
Ponnaiyah Ramajayam Institute of
Science & Technology (PRIST)
(Institution Deemed to be University
's 3 of the UGC Act, 1956)
THANJAVUR - 613 403, TAMIL NADU**

**DEAN
School of Engineering and Tech.
Ponnaiyah Ramajayam Institute of
Science and Technology (PRIST)
Deemed to be University
Vellam, Thanjavur-613 403.**



**PONNAIYAH RAMAJAYAM INSTITUTE OF
SCIENCE & TECHNOLOGY (PRIST)**

Declared as DEEMED TO BE UNIVERSITY
U/s 3 of UGC Act, 1956

From

The HOD,
Department of CSE,
Prist University,
Vallam, Thanjavur.

To:

The DEAN,
Prist University,
Vallam, Thanjavur.

Respected Sir,

Sub: Requesting Permission for conducting Add on Course – Reg.

I wish to bring to your kind information that the department of computer science and engineering has planned to conduct the following Add On course programme for the academic year 2023-24 odd semester.

As the department is equipped with relevant lab facilities and enterprise in the same field, we are requesting the permission for the conduct of the same.

Duration: 45 Hrs.

Thanking You,

Head of the Department
Department of Computer Science
and Engineering
Ponnaiyah Ramajayam Institute of
Science & Technology (PRIST)
(Institution Deemed to be University
U/s 3 of the UGC Act, 1956)
THANJAVUR - 613 403, TAMIL NADU

Yours Truly,

HOD/CSE

DEAN

School of Engineering and Tech.
Ponnaiyah Ramajayam Institute of
Science and Technology (PRIST)
Deemed to be University
Vallam, Thanjavur - 613 403.

DIGITAL MARKETING

COURSE OBJECTIVES:

- To understand the difference between Traditional Marketing and digital Marketing
- To understand and analyze the search engine functions
- To develop a deep knowledge about the Digital marketing platforms and the theoretical aspects of creating a website
- To analyze inbuilt tools for digital Marketing

UNIT I INTRODUCTION TO DIGITAL MARKETING

What is Digital Marketing- Need of Digital Marketing-Digital Marketing Platforms – Understanding digital marketing process- Difference between Traditional Marketing and digital Marketing- tools of Digital marketing - Advantage of Digital Marketing-Digital Marketing Manager Role and functions - How we use both Digital & Traditional Marketing

UNIT II WEBSITE & SEARCH ENGINE

Website –Hosting and Domain– Different platforms for website creation- Introduction to SERP- What are search engines- How search engines work- Major functions of a search engine- What are keywords -Different types of keywords- Google keyword planner tool.

UNIT III MISC TOOLS- GOOGLE WEBMASTER TOOLS

Site Map Creators- Browser-based analysis tools-Page Rank tools-pinging & indexing tools- Dead links identification tools- Open site explorer Domain information/ whois tools- Quick sprout

UNIT IV LEAD MANAGEMENT & DIGITAL MARKETING

Web to lead forms- Web to case forms- Lead generation techniques- Leads are everywhere- Social media and lead gen Inbuilt tools for Digital Marketing-Ip Tracker- CPC reduction (in case of paid ads) Group posting on Social Media platforms.

UNIT V DIGITAL MARKETING SKILL

Search Engine Optimization(SEO)- Search Engine Marketing(SEM).-Social Media Marketing/Optimization- Email Marketing. Website :Product Marketing- Content Writing.

Head of the Department
Department of Computer Science
and Engineering
Ponnaiyah Ramajayam Institute of
Science & Technology (PRIST)
Puliyandilur, Gudalur Taluk, Tiruppur
District, Tamil Nadu
TIRUPPUR-643 403, Tamil Nadu

DEAN
School of Engineering and Tech.
Ponnaiyah Ramajayam Institute of
Science and Technology (PRIST)
Deemed to be University
Vellam, Thanjavur - 613 403.

DIGITAL MARKETING

Nowadays, everyone is connected to the internet through their mobile phones and laptop devices. Understanding why digital marketing is essential for businesses aiming to succeed online through modern marketing and for individuals looking to make a career in digital marketing. Digital marketing, or online marketing, strategically promotes brands, products, or services using various digital channels and technologies. With the rise of the internet and mobile devices, businesses now have huge opportunities to reach a global audience.

Whether through innovative search engine marketing (SEM) strategies or advanced digital marketing software, companies can connect with potential customers like never before. Utilizing search engine optimization (SEO), content marketing, social media advertising, and email marketing allows businesses to effectively reach and engage their target audience, driving growth and achieving marketing objectives.



What is **DIGITAL MARKETING**

Digital marketing is the use of online platforms & digital technologies to promote brands, products, or services.

Types of Digital Marketing

Digital marketing encompasses a wide range of strategies and techniques aimed at promoting products or services through digital channels. Here are the key types of digital marketing:

Handwritten signature in black ink.

Head of the Department
Department of Computer Science
and Engineering
Ponnalyah Ramajayam Institute of
Science & Technology (PRTS-I)
(Institution Deemed to be University
as per the UGC Act 1956)
THANJAVUR - 613 403, TAMIL NADU

Handwritten signature in green ink.

DEAN
School of Engineering and Tech.
Ponnalyah Ramajayam Institute of
Science and Technology (PRTS-I)
Deemed to be University
Vaidan, Thanjavur - 613 403

1. Search Engine Optimization (SEO)

SEO involves optimizing a website to improve its visibility in search engine results pages (SERPs). The goal is to attract organic traffic by using relevant keywords, improving site structure, and earning backlinks. Effective SEO can enhance online visibility and drive long-term traffic.

2. Content Marketing

Content marketing focuses on creating and distributing valuable, relevant content to attract and engage a target audience. This includes blog posts, articles, videos, infographics, and eBooks. The objective is to provide useful information that encourages customer loyalty and drives conversions.

3. Social Media Marketing

Social media marketing involves using platforms like Facebook, Instagram, Twitter, LinkedIn, and TikTok to promote products and engage with customers. This type of marketing can include organic content, paid advertising, and influencer partnerships to reach a broader audience and build brand awareness.

Search Engine Optimization (SEO)

SEO, or Search Engine Optimization, is the process of optimizing your website and content to rank higher on search engine results pages (SERPs). It involves keyword research, on-page optimization, and building high-quality backlinks. For example, Moz, a leading SEO software company, uses SEO services to improve their visibility for high-volume keywords like "SEO tools" and "search engine optimization strategies."

Content Marketing

Content marketing focuses on creating and distributing valuable, relevant content to attract and engage a target audience. This includes blog posts, videos, infographics, and eBooks. HubSpot, a prominent digital marketing agency, utilizes a robust content marketing strategy by offering free resources such as blogs, eBooks, and webinars to drive traffic and generate leads for their marketing automation software.



Head of the Department
Department of Computer Science
and Engineering
Ponnaiyah Ramajayam Institute of
Science & Technology (PRIST)
University, Distance to the University
Villam, Thanjavur - 613 003, Tamil Nadu

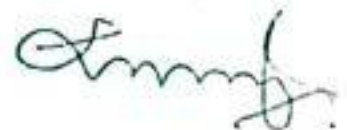

DEAN
School of Engineering and Tech.
Ponnaiyah Ramajayam Institute of
Science and Technology (PRIST)
Deemed to be University
Villam, Thanjavur - 613 003

Social Media Marketing

Social media marketing involves using platforms like Facebook, Instagram, Twitter, and LinkedIn to promote products, engage with customers, and build brand awareness. For example, Nike effectively uses social media advertising on Instagram and Twitter to showcase their products, engage with followers, and drive online sales, often targeting their audience with visually compelling ads.



Head of the Department
Department of Computer Science
and Engineering
Ponnaiyah Ramajayam Institute of
Science & Technology (PRIST)
Kanchi, Tamil Nadu - 613 013



DEAN
School of Engineering and Tech.
Ponnaiyah Ramajayam Institute of
Science and Technology (PRIST)
Deemed to be University
Vaitam, Thanjavur - 613 013



**PONNAIYAH RAMAJAYAM INSTITUTE OF
SCIENCE & TECHNOLOGY (PRIST)**

Declared as DEEMED TO BE UNIVERSITY
By 3 of UGC Act, 1956

DEPARTMENT OF COMPUTER SCIENCE AND ENGINEERING

ACADEMIC YEAR 2023-2024

DIGITAL MARKETING

S.NO	NAME OF THE COURSE	REG NO	NAME/LIST	YEAR/BRANCH
1.	DIGITAL MARKETING	2001CE10101	NIRANJAN. I	IV CSE
2.		2001CE10102	BALAKRISHNAN .S	IV CSE
3.		2001CE10103	M. MANOTHAN	IV CSE
4.		2001CE10105	MUSTHAK HUSSAIN. J	IV CSE
5.		2001CE10106	THIYAGU. S	IV CSE
6.		2001CE10107	NAVEEN. R	IV CSE
7.		2001CE10108	ASHVANTHAN. J.P	IV CSE
8.		2001CE10109	THANOOSHWARAN. R	IV CSE
9.		2001CE10110	NISHANTH. M.R	IV CSE
10.		2001CE10111	BHUVANESH. K	IV CSE
11.		2001CE10112	MAHESHKUMAR	IV CSE
12.		2001CE10201	SUBIKSHA. S	IV CSE
13.		2001CE10202	RAJASHREE	IV CSE
14.		2004CE10101	DEV AKASH. S	IV CSE
15.		2004CE10102	MOHAMED ABDUL KALAM	IV CSE
16.		2004CE10104	M. HARIHARAN	IV CSE
17.		2101CE13101	APPAPPAN DEEPAK PETHAIAH. P.M	IV CSE
18.		2101CE13102	BALAMURUGAN. S	IV CSE
19.		2101CE13103	SANJAY KANNAI	IV CSE

Head of the Department
Department of Computer Science
and Engineering
Ponnaiyah Ramajayam Institute of
Science & Technology (PRIST)
(Institution Deemed to be University
By 3 of the UGC Act, 1956)
THANJAVUR - 613 405, TAMIL NADU

DEAN
School of Engineering and Tech.
Ponnaiyah Ramajayam Institute of
Science and Technology (PRIST)
Deemed to be University
Vallam, Thanjavur-613 405

20.		2101CE13104	PRASANNA NARAYANAN. S	IV CSE
21.		2101CE13105	SIVAKUMARAN.V	IV CSE
22.		2101CE13129	VIGNESH.B	IV CSE
23.		1901CE1008	DEENADAYALAN.A	IV CSE
24.		2101CE1001	MOHAMED JAVID.M	IV CSE
25.		2101CE1002	SHAHEEN S	IV CSE
26.		2101CE1003	MOHAMED HISHAM.P	IV CSE
27.		2101CE1004	AJAY KUMAR.S	IV CSE
28.		2101CE1006	HARI HARAN B	IV CSE
29.		2101CE1007	APARNA.R	IV CSE
30.		2101CE1008	MOHAMED SIDDIK.S	IV CSE
31.		2101CE1009	ANJANA DEVI.S	IV CSE
32.		2101CE1010	SHRI JANAHI	IV CSE
33.		2101CE1011	GOVINDHA RAJ.J	IV CSE
34.		2101CE1012	KARTHIKEYAN.N	IV CSE
35.		2101CE1013	VARUN.M	IV CSE
36.		2101CE1602	VAIRARAMANATHAN.V	IV CSE
37.		2101CE1501	HARIPRASAD.R	IV CSE
38.		2101CE1615	SYED THAMEEM ASHIK Z.	IV CSE
39.		2101CE1617	DINESH. L	IV CSE
40.		2101CE1620	HARIHARAN. K	IV CSE
41.		2101CE1014	MOHAMED HAJA.M	IV CSE
42.		2101CE1015	SAHANA. S	IV CSE
43.		2101CE1016	MOHAMED ASIK.S	IV CSE
44.		2101CE1017	AJAY .K	IV CSE
45.		2101CE1018	HARI.M	IV CSE

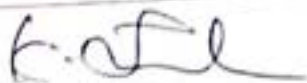

Head of the Department
Department of Computer Science
and Engineering
Ponnaiyah Ramajayam Institute of
Science & Technology (P.R.I.T.)
(Institution Deemed to be University
by Section 3 of the UGC Act, 1956)
THANJAVUR - 612 403, TAMIL NADU



DEAN
School of Engineering and Tech.
Ponnaiyah Ramajayam Institute of
Science and Technology (P.R.I.T.)
Deemed to be University
Vallam, Thanjavur - 612 403

46.	2101CE1019	AKSHAYA.A	IV CSE
47.	2101CE1020	MOHAMED ASIF.S	IV CSE
48.	2101CE1021	PRAKASH.V	IV CSE
49.	2101CE1022	HARSHA.B	IV CSE
50.	2101CE1023	MOHAMED HISHAM.S	IV CSE
51.	2101CE1024	NISHA.D	IV CSE
52.	2101CE1025	DIVYABHARATHI.R	IV CSE
53.	2101CE1026	AGALYA.S	IV CSE
54.	2101CE1027	VINOTH.M	IV CSE
55.	2101CE1028	VISHAN.J	IV CSE
56.	2101CE1029	PRATHIKSHA.S	IV CSE
57.	2101CE1030	PRAVEEN.M	IV CSE
58.	2101CE1031	ROSHIGA DEVI .R.N	IV CSE

 Head of the Department
 Department of Computer Science
 and Engineering
 Ponnaiyah Ramajayam Institute of
 Science & Technology (Autonomous)
 (Insulation Deemed to be University
 's 3 of the UGC Act, 1956)
 THANJAVUR - 613 403, TAMIL NADU

 DEAN
 School of Engineering and Tech.
 Ponnaiyah Ramajayam Institute of
 Science and Technology (PRIST)
 Deemed to be University
 Vallam, Thanjavur - 613 403.



**PONNAIYAH RAMAJAYAM INSTITUTE OF
SCIENCE & TECHNOLOGY (PRIST)**

DECLARED AS DEEMED TO BE UNIVERSITY
BY U 3 OF UGC ACT, 1956

DEPARTMENT OF COMPUTER SCIENCE AND ENGINEERING

ACADEMIC YEAR 2023-2024

TIME TABLE - DIGITAL MARKETING

MONTH	DATE	HOURS
JULY	13.07.23	45HRS
	14.07.23	
	17.07.23	
	18.07.23	
	19.07.23	
	20.07.23	
	21.07.23	
	24.07.23	
	25.07.23	

Head of the Department
Department of Computer Science
and Engineering
Ponnaiyah Ramajayam Institute of
Science & Technology (PRIST)
(Institution Deemed to be University
by U 3 of the UGC Act, 1956)
THANJAVUR - 613 403, TAMIL NADU

DEAN
School of Engineering and Tech.
Ponnaiyah Ramajayam Institute of
Science and Technology (PRIST)
Deemed to be University
Kannur, Pathanamthitta - 689 123



PONNAIYAH RAMAJAYAM INSTITUTE OF
SCIENCE & TECHNOLOGY (PRIST)

DECLARED AS DEEMED TO BE UNIVERSITY
BY 3 OF UGC ACT, 1956

SCHOOL OF ENGINEERING AND TECHNOLOGY
DEPARTMENT OF COMPUTER SCIENCE AND ENGINEERING

CIRCULAR

SUB: ADD ON COURSE-Reg.

It is informed that the department of computer science and engineering is planning to organized a certified course on Data Science on 08.09.23 for the academic year 2023-2024 odd semester. The detailed schedule will be given by the departments. Head of the departments are requested to inform their students about the certified course on Data Science and motivate them to attend the course. HOD's are requested to nominate one faculty member to co-ordinate the same.

Head of the Department,
Department of Computer Science
and Engineering
Ponnaiyah Ramajayam Institute of
Science & Technology (PRIST)
(Insulation Deemed to be University
by 3 of the UGC Act, 1956)
THANJAVUR - 613 403, TAMIL NADU

DEAN
School of Engineering and Tech.
Ponnaiyah Ramajayam Institute of
Science and Technology (PRIST)
Deemed to be University
Vallam, Thanjavur - 613 403.



**PONNAIYAH RAMAJAYAM INSTITUTE OF
SCIENCE & TECHNOLOGY (PRIST)**

DECLARED AS DEEMED TO BE UNIVERSITY
UNDER SECTION 3 OF THE UGC ACT, 1956

From

The HOD,
Department of CSE,
Prist University,
Vallam, Thanjavur.

To:

The DEAN,
Prist University,
Vallam, Thanjavur.

Respected Sir,

Sub:- Requesting Permission for conducting Add on Course – Reg-

I wish to bring to your kind information that the department of computer science and engineering has planned to conduct the following Add On course programme for the academic year 2023-24 odd semester.

As the department is equipped with relevant lab facilities and enterprise in the same field, we are requesting the permission for the conduct of the same.

Duration: 45 Hrs.

Thanking You,

Yours Truly,

HOD/CSE

Head of the Department
Department of Computer Science
and Engineering
Ponnaiyah Ramajayam Institute of
Science & Technology (PRIST)
(Institution Deemed to be University
under Section 3 of the UGC Act, 1956)
THANJAVUR - 613 403, TAMIL NADU

DEAN
School of Engineering and Tech.
Ponnaiyah Ramajayam Institute of
Science and Technology (PRIST)
Deemed to be University
Vallam, Thanjavur - 613 403.

DATA SCIENCE

COURSE OUTCOMES:

- To understand the techniques and processes of data science
- To apply descriptive data analytics
- To visualize data for various applications
- To understand inferential data analytics
- To analysis and build predictive models from data

UNIT I INTRODUCTION TO DATA SCIENCE

Need for data science - benefits and uses - facets of data - data science process - setting the research goal - retrieving data - cleansing, integrating, and transforming data - exploratory data analysis - build the models - presenting and building applications.

UNIT II DESCRIPTIVE ANALYTICS

Frequency distributions - Outliers - interpreting distributions - graphs - averages - describing variability - Interquartile range - variability for qualitative and ranked data - Normal distributions - z scores - correlation - scatter plots - regression - regression line .

UNIT III INFERENCE STATISTICS

Populations - samples - random sampling - Sampling distribution - standard error of the mean - Hypothesis testing - z-test - z-test procedure - decision rule - calculations - decisions - interpretations

UNIT IV ANALYSIS OF VARIANCE

t-test for one sample - sampling distribution of t - t-test procedure - t-test for two independent samples - p-value - statistical significance - t-test for two related samples, F-test - ANOVA - Two-factor experiments - three F-tests - two-factor ANOVA - Introduction to chi-square tests.

UNIT V PREDICTIVE ANALYTICS

Linear least squares - implementation - goodness of fit - testing a linear model - weighted resampling, Regression using StatsModels - multiple regression - nonlinear relationships - logistic regression .



Head of the Department
Department of Computer Science
and Engineering
Ponnaiyah Ramajayam Institute of
Science & Technology (PRTI)
(Institution Deemed to be University)
File 3 of the 1265, 2011
TIRUNELVELI - 612 013, Tamil Nadu - 612 013



DEAN
School of Engineering and Tech.
Ponnaiyah Ramajayam Institute of
Science and Technology (PRTI)
Deemed to be University
Vattam, Tirunelveli - 612 013

DATA SCIENCE

In a world of data space where organizations deal with petabytes and exabytes of data, the era

of Big Data emerged, and the essence of its storage also grew. It was a great



challenge and concern for industries for the storage of data until 2010. Now when frameworks like Hadoop and others solved the problem of storage, the focus shifted to the processing of data. Data Science plays a big role here. All those fancy Sci-fi movies you love to watch around can be turned into reality by Data Science.

Nowadays its growth has been increased in multiple ways and thus one should be ready for our future by learning what it is and how can we add value to it.

Data science is not a one-step process such that you will get to learn it in a short time and call ourselves a Data Scientist. It's passes from many stages and every element is important. One should always follow the proper steps to reach the ladder. Every step has its value and it counts in your model. Buckle up in your seats and get ready to learn about those steps.

Head of the Department
Department of Computer Science
and Engineering
Ponnalyah Ramajayam Institute of
Science & Technology (PRIST)
(Inclusion Deemed to be University
As 3 of the UGC Act, 1956)
THANJAVUR - 613 403, TAMIL NADU

DEAN
School of Engineering and Tech.
Ponnalyah Ramajayam Institute of
Science and Technology (PRIST)
(Inclusion Deemed to be University
As 3 of the UGC Act, 1956)
Vandalur, Thanjavur - 613 403.

1. Problem Statement:

No work start without motivation, Data science is no exception though. It's really important to declare or formulate your problem statement very clearly and precisely. Your whole model and it's working depend on your statement. Many scientist considers this as the main and much important step of Data Science. So make sure what's your problem statement and how well can it add value to business or any other organization.

2. Data Collection:

After defining the problem statement, the next obvious step is to go in search of data that you might require for your model. You must do good research, find all that you need. Data can be in any form i.e unstructured or structured. It might be in various forms like videos, spreadsheets, coded forms, etc. You must collect all these kinds of sources.

3. Data Cleaning:

As you have formulated your motive and also you did collect your data, the next step to do is cleaning. Yes, it is! Data cleaning is the most favorite thing for data scientists to do. Data cleaning is all about the removal of missing, redundant, unnecessary and duplicate data from your collection. There are various tools to do so with the help of programming in either R or Python. It's totally on you to choose one of them. Various scientist have their opinion on which to choose. When it comes to the statistical part, R is preferred over Python, as it has the privilege of more than 12,000 packages. While python is used as it is fast, easily accessible and we can perform the same things as we can in R with the help of various packages.

4. Data Analysis and Exploration:

It's one of the prime things in data science to do and time to get inner Holmes out. It's about analyzing the structure of data, finding hidden patterns in them, studying behaviors, visualizing the effects of one variable over others and then concluding. We can explore the data with the help of various graphs formed with the help of libraries using any programming language. In R, GGplot is one of the most famous models while Matplotlib in Python.



Head of the Department
Department of Computer Science
and Engineering
Ponnaiyah Ramajayam Institute of
Science & Technology (PRIST)
(Institution Accredited by the University
of Applied Sciences, UAS, Chennai)
TANJAVUR - 612 022, Tamil Nadu



DEAN
School of Engineering and Tech.
Ponnaiyah Ramajayam Institute of
Science and Technology (PRIST)
Deemed to be University
Veeramp, Thanjavur - 612 022

5. Data Modelling:

Once you are done with your study that you have formed from data visualization, you must start building a hypothesis model such that it may yield you a good prediction in future. Here, you must choose a good algorithm that best fit to your model. There different kinds of algorithms from regression to classification, SVM(Support vector machines), Clustering, etc. Your model can be of a Machine Learning algorithm. You train your model with the train data and then test it with test data. There are various methods to do so.

6. Optimization and Deployment:

You followed each and every step and hence build a model that you feel is the best fit. But how can you decide how well your model is performing? This where optimization comes. You test your data and find how well it is performing by checking its accuracy. In short, you check the efficiency of the data model and thus try to optimize it for better accurate prediction. Deployment deals with the launch of your model and let the people outside there to benefit from that. You can also obtain feedback from organizations and people to know their need and then to work more on your model.

Head of the Department
Department of Computer Science
and Engineering
Ponnalyah Ramajayam Institute of
Science & Technology (P.R.I.S.T.)
(Institution Deemed to be University
under Section 3 of the UGC Act, 1956)
THANJAVUR - 613 403, TAMIL NADU

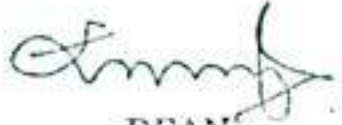
DEAN
School of Engineering and Tech.
Ponnalyah Ramajayam Institute of
Science and Technology (PRIST)
Deemed to be University
Vallam, Thanjavur - 613 403.



**PONNAIYAH RAMAJAYAM INSTITUTE OF
SCIENCE & TECHNOLOGY (PRIST)**

Declared as DEEMED TO BE UNIVERSITY
Uts 3 of UGC Act, 1956

DEPARTMENT OF COMPUTER SCIENCE AND ENGINEERING

ACADEMIC YEAR 2023-2024

DATA SCIENCE

S.NO	NAME OF THE COURSE	REGNO	NAME/LIST	YEAR/BRANC H
1.	DATA SCIENCE	2101CE10201	R.KEERATHIANA	III CSE
2.		2101CE10202	S.ABINAYA	III CSE
3.		2101CE10101	S.AJAY KUMAR	III CSE
4.		2101CE10102	N.SURYA PRAKASH	III CSE
5.		2101CE10103	R.PRAVEEN	III CSE
6.		2101CE10104	S.ABISHAKE	III CSE
7.		2210CE13101	R.BALAJI	III CSE
8.		2201CE13102	A.DINESH KUMAR	III CSE
9.		2101CE13201	A.BAVA DHARANI	III CSE
10.		2101CE13202	P.GOWRI BHAVANA	III CSE
11.		2201CE13106	M.SUGANEESHWARAN	III CSE
12.		2201CE13109	U.RAGUL	III CSE
13.		2101CE13203	M.VISHVADIHARSHINI	III CSE
14.		2101CE13204	G.SURIYA	III CSE
15.		2201CE13103	J.NOOR MOHAMED	III CSE
16.		2201CE13104	N.VIGNESH	III CSE
17.		2201CE13105	K.S.NAVEEN	III CSE
18.		2101CE13231	A.VIGNESH KUMAR	III CSE
19.		2201CE13107	VENKATESHWARAN	III CSE

Head of the Department
Department of Computer Science
and Engineering
Ponnaiyah Ramajayam Institute of
Science & Technology (PRIST)
(Institution Deemed to be University
Uts 3 of the UGC Act, 1956)
THANJAVUR - 613 403, TAMIL NADU

DEAN
School of Engineering and Tech.
Ponnaiyah Ramajayam Institute of
Science and Technology (PRIST)
Deemed to be University
Vallam, Thanjavur - 613 403

20.		2201CE13110	G.PARVIN	III CSE
21.		2101CE13206	S.SUSHIMA	III CSE
22.		2201CE13111	P.GOWTHAM	III CSE
23.		2201CE13112	R.SATHIS KANNAN	III CSE
24.		2201CE13113	KIYAS J	III CSE

 Head of the Department
 Department of Computer Science
 and Engineering
 Pennaiyeh Ramajayam Institute of
 Science & Technology (P.R.I.S.T.)
 Unit 3 of the IASO, Anna Salai,
 THANJAVUR - 613 403, TAMIL NADU

 DEAN
 School of Engineering and Tech.
 Pennaiyeh Ramajayam Institute of
 Science and Technology (P.R.I.S.T.)
 Deemed to be University
 Vallam, Thanjavur-613 403.



**PONNAIYAH RAMAJAYAM INSTITUTE OF
SCIENCE & TECHNOLOGY (PRIST)**

Declared as DEEMED TO BE UNIVERSITY
U/S 3 of UGC Act, 1956

DEPARTMENT OF COMPUTER SCIENCE AND ENGINEERING

ACADEMIC YEAR 2023-2024

TIME TABLE - DATA SCIENCE

MONTH	DATE	HOURS
SEPTEMBER	12.09.23	45HRS
	13.09.23	
	14.09.23	
	15.09.23	
	18.09.23	
	19.09.23	
	20.09.23	
	21.09.23	
22.09.23		

Head of the Department
Department of Computer Science
and Engineering
Ponnaiyah Ramajayam Institute of
Science & Technology (PRIST)
(Institution Deemed to be University
U/S 3 of the UGC Act, 1956)
THANJAVUR - 613 403, Tamil Nadu

DEAN
School of Engineering and Tech.
Ponnaiyah Ramajayam Institute of
Science and Technology (PRIST)
Deemed to be University
Vaitam, Thanjavur - 613 403.



**PONNAIYAH RAMAJAYAM INSTITUTE OF
SCIENCE & TECHNOLOGY (PRIST)**

Declared as DEEMED TO BE UNIVERSITY
Dis. 3 of UGC Act, 1956

SCHOOL OF ENGINEERING AND TECHNOLOGY

DEPARTMENT OF COMPUTER SCIENCE AND ENGINEERING

CIRCULAR

SUB: ADD ON COURSE-Reg.,

It is informed that the department of computer science and engineering is planning to organized a certified course on Ethical Hacking on 03.11.23 for the academic year 2023-2024 odd semester. The detailed schedule will be given by the departments. Head of the departments are requested to inform their students about the certified course on Ethical Hacking and motivate them to attend the course. HOD's are requested to nominate one faculty member to co-ordinate the same.

Head of the Department
Department of Computer Science
and Engineering
Ponnaiyah Ramajayam Institute of
Science & Technology
Deemed to be University
Vallam, Thanjavur - 613 463

DEAN
School of Engineering and Tech.
Ponnaiyah Ramajayam Institute of
Science and Technology (PRIST)
Deemed to be University
Vallam, Thanjavur - 613 463.



**PONNAIYAH RAMAJAYAM INSTITUTE OF
SCIENCE & TECHNOLOGY (PRIST)**

Declared as DEEMED TO BE UNIVERSITY
U/s 3 of UGC Act, 1956

From

The HOD,
Department of CSE,
Prist University,
Vallam, Thanjavur.

To:

The DEAN,
Prist University,
Vallam, Thanjavur.

Respected Sir,

Sub:- Requesting Permission for conducting Add on Course – Reg.

I wish to bring to your kind information that the department of computer science and engineering has planned to conduct the following Add On course programme for the academic year 2023-24 odd semester.

As the department is equipped with relevant lab facilities and enterprise in the same field, we are requesting the permission for the conduct of the same.

Duration: 45 Hrs.

Thanking You,

Yours Truly,
HOD/CSE

Head of the Department
Department of Computer Science
and Engineering
Ponnaiyah Ramajayam Institute of
Science & Technology
(Institution Deemed to be University
U/s 3 of the UGC Act, 1956)
THANJAVUR - 612 402, Tamil Nadu

DEAN
School of Engineering and Tech.
Ponnaiyah Ramajayam Institute of
Science and Technology (PRIST)
Deemed to be University
Vallam, Thanjavur - 613 403.

ETHICAL HACKING

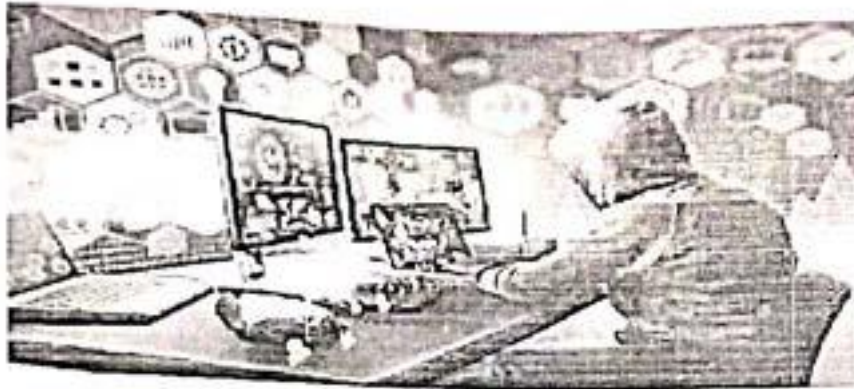

Who is a Certified Ethical Hacker?

A Certified Ethical Hacker is a specialist typically working in a red team environment, focused on attacking computer systems and gaining access to networks, applications, databases, and other critical data on secured systems. A C|EH[®] understands attack strategies, the use of creative attack vectors, and mimics the skills and creativity of malicious hackers. Unlike malicious hackers and actors, Certified Ethical Hackers operate with permission from the system owners and take all precautions to ensure the outcomes remain confidential. Bug bounty researchers are expert ethical hackers whose attack skills are used to uncover vulnerabilities in the systems.

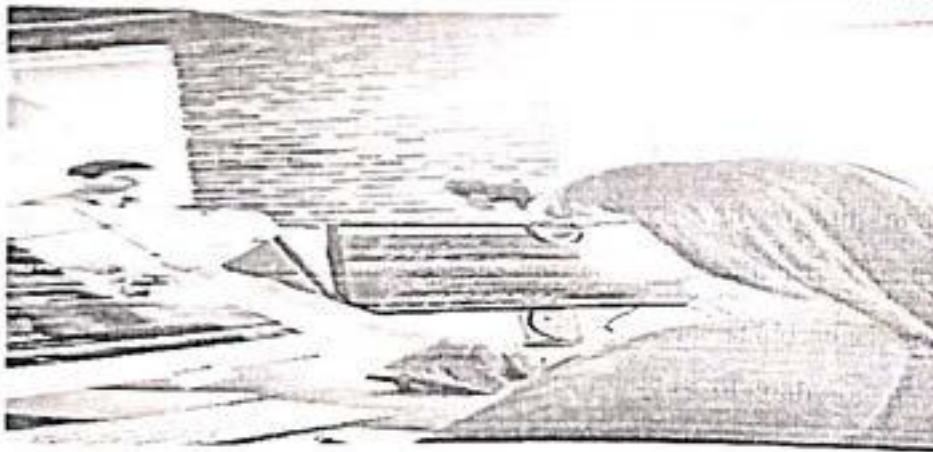

Head of the Department
Department of Computer Science
and Engineering
Ponnaiyah Ramajayam Institute of
Science & Technology (PRIST)
Deemed to be University
Vellambadi, Thanjavur - 613 403.



DEAN
School of Engineering and Tech.
Ponnaiyah Ramajayam Institute of
Science and Technology (PRIST)
Deemed to be University
Vellambadi, Thanjavur - 613 403.

What is C|EH® v12?

The Certified Ethical Hacker has been battle-hardened over the last 20 years, creating hundreds of thousands of Certified Ethical Hackers employed by top companies, militaries, and governments worldwide. In its 12th version, the Certified Ethical Hacker provides comprehensive training, hands-on learning labs, practice cyber ranges for engagement, certification assessments, cyber competitions, and opportunities for continuous learning into one comprehensive program curated through our new learning framework: 1. Learn 2. Certify 3. Engage 4. Compete.

RECONNAISSA

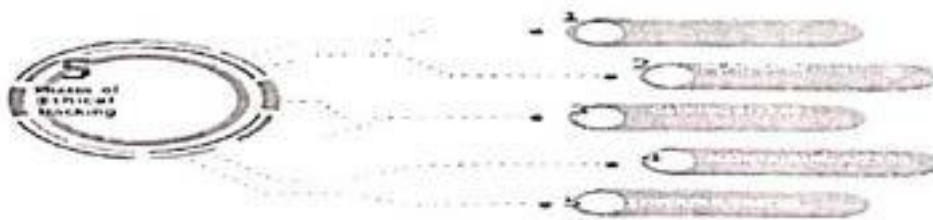
The C|EH® v12 is a specialized and one-of-a-kind training program to teach you everything you need to know about ethical hacking with hands-on training, labs, assessment, a mock engagement (practice), and global hacking competition. Stay on top of the game with the most in-demand skills required to succeed in the field of cyber security.



COURSE OUTCOMES:

At the end of this course, the students will be able:

1. To express knowledge on basics of computer based vulnerabilities
2. To gain understanding on different footprinting, reconnaissance and scanning methods.
3. To demonstrate the enumeration and vulnerability analysis methods
4. To gain knowledge on hacking options available in Web and wireless applications.
5. To acquire knowledge on the options for network protection.

Head of the Department
Department of Computer Science
and Engineering
Pennalyah Ramayya Institute of
Science & Technology
(Institution Deemed to be University
33 of 1st Ave, Valiam,
THANJAVUR - 613 403, Tamil Nadu)

DEAN
School of Engineering and Tech.
Pennalyah Ramayya Institute of
Science and Technology (PRIST)
Deemed to be University
Valiam, Thanjavur - 613 403.

ETHICAL HACKING

UNIT I INTRODUCTION TO HACKING

Introduction to Hacking – Important Terminologies – Penetration Test – Vulnerability Assessments versus Penetration Test – Pre-Engagement – Rules of Engagement – Penetration Testing Methodologies – OSSTMM – NIST – OWASP – Categories of Penetration Test – Types of Penetration Tests – Vulnerability Assessment Summary – Reports .

UNIT II FOOT PRINTING AND RECONNAISSANCE

Scanning Networks – Enumeration - Vulnerability Analysis - System Hacking - Malware Threats – Sniffing.

UNIT-III NETWORK ATTACKS

Vulnerability Data Resources – Exploit Databases – Network Sniffing – Types of Sniffing - Promiscuous versus Non promiscuous Mode – MITM Attacks – ARP Attacks – Denial of Service Attacks -Hijacking Session with MITM Attack – SSL Strip: Stripping .

UNIT IV TYPES OF HACKERS

Black Hat Hacker - White Hat Hacker - Grey Hat Hacker - Hacking Process - Foot Printing – Scanning - Gaining Access - Maintaining Access.

UNIT V WIRELESS AND WEB HACKING

Wireless Hacking – Introducing Aircrack- Cracking the WEP – Cracking a WPA/WPA2 Wireless Network Using Aircrack-ng – Evil Twin Attack – Causing Denial of Service on the Original AP.



Head of the Department
Department of Computer Science
and Engineering
Ponnaiyah Ramajayam Institute of
Science & Technology (PRIST)
(Institution Deemed to be University
's 3 of the District)
THANJAVUR - 613 403, TANJAVUR DISTRICT



DEAN
School of Engineering and Tech.
Ponnaiyah Ramajayam Institute of
Science and Technology (PRIST)
Deemed to be University
Vallam, Thanjavur - 613 403.

CERTIFICATE OF COMPLETION



**PRIST SCHOOL OF ENGINEERING &
TECHNOLOGY VALLAM, THANAJVUR-613 403**

DEPARTMENT OF COMPUTER SCIENCE AND ENGINEERING

This is to certify that Mr /Ms. R. KEERTHANA of _____
III-CSE has successfully completed the _____
Data Science Add on Course from 12.09.23 to
22.09.23

CO-ORDINATOR

HOD

DEAN
DEAN

Head of the Department
Department of Computer Science
and Engineering,
Ponnaiyah Ramajayam Institute of
Science & Technology (PRIST)

Department of Computer Science
and Engineering,
Ponnaiyah Ramajayam Institute of
Science & Technology (PRIST)
Vallam, Thanjavur - 613 403, Tamil Nadu

School of Engineering and Tech.
Ponnaiyah Ramajayam Institute of
Science and Technology (PRIST)
Deemed to be University
Vallam, Thanjavur-613 403.

CERTIFICATE OF COMPLETION



**PRIST SCHOOL OF ENGINEERING &
TECHNOLOGY VALLAM, THANAJVUR-613 403**

DEPARTMENT OF COMPUTER SCIENCE AND ENGINEERING

This is to certify that Mr/Ms. G. PRAVIN of _____
III-CSE has successfully completed the _____
Data Science Add on Course from 12.09.23 to _____

22.09.23.

CO-ORDINATOR

HOD

DEAN

Head of the Department
Department of Computer Science
and Engineering

Ponnalyah Ramajayam Institute of
Science & Technology (P.R.I.S.T.)
(Insulation Deemed to be University)
5/3 of the UGC Act
THANAJVUR - 613 403, Tamil Nadu

School of Engineering and Tech.
Ponnalyah Ramajayam Institute of
Science and Technology (PRIST)
Deemed to be University
Vallam, Thanajvur - 613 403

CERTIFICATE OF COMPLETION



**PRIST SCHOOL OF ENGINEERING &
TECHNOLOGY VALLAM, THANANJVUR-613 403**

DEPARTMENT OF COMPUTER SCIENCE AND ENGINEERING

This is to certify that Mr/Ms. KANISHA.R of
 III-CSE has successfully completed the
Ethical Hacking Add on Course from 07.11.23 to
17.11.23.

CO-ORDINATOR

HOD

Head of the Department
Department of Computer Science
and Engineering

Ponnalyah Ramalayam Institute of
Science & Technology

(Autonomous, Omenon to be
of the UGC)

THANANJVUR - 613 403, INDIA

DEAN

School of Engineering and Tech,
Ponnalyah Ramalayam Institute of
Science and Technology (PRIST)
Department to be University
Vallam, Thananjvur-613 403

CERTIFICATE OF COMPLETION



**PRIST SCHOOL OF ENGINEERING &
TECHNOLOGY VALLAM, THANAJVUR-613 403**

DEPARTMENT OF COMPUTER SCIENCE AND ENGINEERING

This is to certify that Mr /Ms. KIRUTHIGA.A.D of III-CSE has successfully completed the Ethical Hacking Add on Course from 07.11.23 to 17.11.23.

CO-ORDINATOR

HOD

DEAN

Head of the Department
Department of Computer Science
and Engineering
Ponnalyah Ramalayam Institute of
Science & Technology,
(Institution Deemed to be Equivalent to the UGC)
THANAJVUR - 613 403, Tamil Nadu

School of Engineering and Tech.
Ponnalyah Ramalayam Institute of
Science and Technology (P.R.T.)
Deemed to be University
Vandalur, Thanjavur - 613 403, Tamil Nadu

CERTIFICATE OF COMPLETION



**PRIST SCHOOL OF ENGINEERING &
TECHNOLOGY VALLAM, THANAJVUR-613 403**

DEPARTMENT OF COMPUTER SCIENCE AND ENGINEERING

This is to certify that Mr/Ms. DEV AKASH - S of _____
IT - CSE has successfully completed the _____
Embedded systems and IoT Add on Course from 09.01.24 to
25.01.24.

CO-ORDINATOR

HOD

DEAN

**Head of the Department
Department of Computer Science
and Engineering**

**Ponnalyah Ramalayam Institute of
Science & Technology (P
(Institution Deemed to be
3 of the UGT, A
THANAJVUR - 613 403, In**

**School of Engineering and Tech.
Ponnalyah Ramalayam Institute of
Science and Technology (PRIST)
Vallam, Thanajvur - 613 403**

CERTIFICATE OF COMPLETION



**PRIST SCHOOL OF ENGINEERING &
TECHNOLOGY VALLAM, THANAJVUR-613 403**

DEPARTMENT OF COMPUTER SCIENCE AND ENGINEERING

This is to certify that Mr/Ms. VIQ MESH.B of _____
IV-CSE has successfully completed the _____
Embedded Systems and ToT Add on Course from 09.01.24 to 25.01.24.

CO-ORDINATOR

HOD

DEAN
School of Engineering and Technology
Ponnalyah Ramalayam Institute of
Science and Technology (PRIST)
Deemed to be University
Vallam, Thanjavur-613

Head of the Department
Department of Computer Science
and Engineering
Ponnalyah Ramalayam Institute of
Science & Technology
Institution Deemed to be
University
Vallam, Thanjavur-613

CERTIFICATE OF COMPLETION



**PRIST SCHOOL OF ENGINEERING &
TECHNOLOGY VALLAM, THANAJVUR-613 403**

DEPARTMENT OF COMPUTER SCIENCE AND ENGINEERING

This is to certify that Mr /Ms. G. SURIGA of _____
III - CSE has successfully completed the _____
Neural Networks Add on Course from 07.03.24 to

19.03.24.

CO-ORDINATOR

HOD

**Head of the Department
Department of Computer Science
and Engineering**

Ponnalyah Ramalayan

Science & Technology

(Institute for Quality Education)

Prattinagar, Thanjavur, Tamil Nadu

DEAN
School of Engineering and Tech.
Ponnalyah Ramalayan Institute of
Science and Technology (PRIST)
Dummett to be University
Vallam, Thanjavur-613

CERTIFICATE OF COMPLETION



**PRIST SCHOOL OF ENGINEERING &
TECHNOLOGY VALLAM, THANAJVUR-613 403**

DEPARTMENT OF COMPUTER SCIENCE AND ENGINEERING

This is to certify that Mr/Ms. R. BALAJI of
 IT-CSE has successfully completed the
 Neural Networks Add on Course from 07.03.24 to
19.03.24.

CO-ORDINATOR

HOD

DEAN

Head of the Department:
Department of Computer Science
and Engineering

Ponnaiyah Ramalayah Institute of
Science & Technology (PRIST)
(Institution Deemed to be University
'B' of the UGC Act, 1956)
THANAJVUR - 613 403, TAMIL NADU

School of Engineering and Tech,
Ponnaiyah Ramalayah Institute of
Science and Technology (PRIST)
THANAJVUR - 613 403, TAMIL NADU



**PONNAIYAH RAMAJAYAM INSTITUTE OF
SCIENCE & TECHNOLOGY (PRIST)**

Declared as DEEMED TO BE UNIVERSITY
U/s 3 of UGC Act, 1956

SCHOOL OF ENGINEERING AND TECHNOLOGY

Department of Artificial Intelligence and Data Science

Academic year 2023-2024

Experimental Learning

Head of the Department
Department of Computer Science
and Engineering
Ponnaiyah Ramajayam Institute of
Science & Technology (PRIST)
(Institution Deemed to be University
U/s 3 of the UGC Act, 1956)
THANJAVUR - 613 403, TAMIL NADU

DEAN
School of Engineering and Tech.
Ponnaiyah Ramajayam Institute of
Science and Technology (PRIST)
Deemed to be University
Vellam, Thanjavur - 613 403.



PONNAIYAH RAMAJAYAM INSTITUTE OF SCIENCE & TECHNOLOGY (PRIST)

Declared as DEEMED TO BE UNIVERSITY
Uis 3 of UGC Act, 1956

DATA STRUCTURES DESIGN

COURSE OBJECTIVES:

- To implement ADTs in Python
- To design and implement linear data structures – lists, stacks, and queues
- To implement sorting, searching and hashing algorithms
- To solve problems using tree and graph structures

LIST OF EXPERIMENTS:

1. Implement simple ADTs as Python classes
2. Implement recursive algorithms in Python
3. Implement List ADT using Python arrays
4. Linked list implementations of List
5. Implementation of Stack and Queue ADTs
6. Applications of List, Stack and Queue ADTs
7. Implementation of sorting and searching algorithms
8. Implementation of Hash tables
9. Tree representation and traversal algorithms
10. Implementation of Binary Search Trees
11. Implementation of Heaps
12. Graph representation and Traversal algorithms
13. Implementation of single source shortest path algorithm
14. Implementation of minimum spanning tree algorithms

Head of the Department
Department of Computer Science
and Engineering
Ponnaiyah Ramajayam Institute of
Science & Technology (Pr)
(Institution Deemed to be University
'a 3 of the UGC Act, 1956')
TANJAVUR - 613 403, TAMIL NADU

DEAN
School of Engineering and Tech.
Ponnaiyah Ramajayam Institute of
Science and Technology (PRIST)
Deemed to be University
Valiam, Thanjavur-613 403.



**PONNAIYAH RAMAJAYAM INSTITUTE OF
SCIENCE & TECHNOLOGY (PRIST)**

Declared as DEEMED TO BE UNIVERSITY
U/s 3 of UGC Act, 1956

SCHOOL OF ENGINEERING AND TECHNOLOGY

Department of Artificial Intelligence and Data Science

Academic year 2023-2024

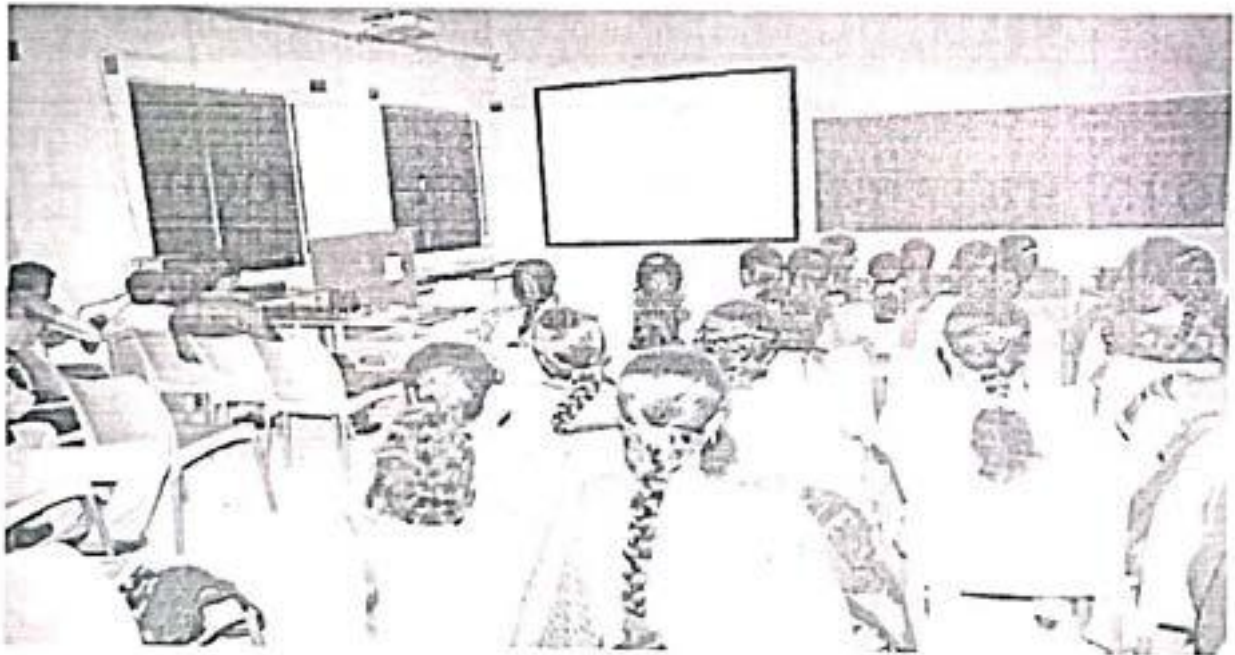

**Head of the Department
Department of Computer Science
and Engineering**

**Ponnaiyah Ramajayam Institute of
Science & Technology (PRIST)**
(Institution Deemed to be University
U/s 3 of the UGC Act 1956)
THANJAVUR - 613 403, TAMIL NADU

DEAN
School of Engineering and Tech.
**Ponnaiyah Ramajayam Institute of
Science and Technology (PRIST)**
Deemed to be University
Vallam, Thanjavur - 613 403.



PONNAIYAH RAMAJAYAM INSTITUTE OF SCIENCE & TECHNOLOGY (PRIST)

Declared as DEEMED TO BE UNIVERSITY
Uis 3 of UGC Act 1956

MACHINE LEARNING LABORATORY

- To understand the data sets and apply suitable algorithms for selecting the appropriate features for analysis.
- To learn to implement supervised machine learning algorithms on standard datasets and evaluate their performance.
- To experiment the unsupervised machine learning algorithms on standard datasets and evaluate their performance.
- To build the graph based learning models for standard data sets.
- To compare the performance of different ML algorithms and select the suitable one based on the application.

LIST OF EXPERIMENTS:

1. For a given set of training data examples stored in a .CSV file, implement and demonstrate the **Candidate-Elimination algorithm** to output a description of the set of all hypotheses consistent with the training examples.
2. Write a program to demonstrate the working of the decision tree based **ID3 algorithm**. Use an appropriate data set for building the decision tree and apply this knowledge to classify a new sample.
3. Build an Artificial Neural Network by implementing the **Backpropagation algorithm** and test the same using appropriate data sets.
4. Write a program to implement the **naïve Bayesian classifier** for a sample training data set stored as a .CSV file and compute the accuracy with a few test data sets.
5. Implement **naïve Bayesian Classifier** model to classify a set of documents and measure the accuracy, precision, and recall.
6. Write a program to construct a **Bayesian network** to diagnose CORONA infection using standard WHO Data Set.
7. Apply **EM algorithm** to cluster a set of data stored in a .CSV file. Use the same data set for clustering using the **k-Means algorithm**. Compare the results of these two algorithms.
8. Write a program to implement **k-Nearest Neighbour algorithm** to classify the iris data set. Print both correct and wrong predictions.
9. Implement the non-parametric **Locally Weighted Regression algorithm** in order to fit datapoints. Select an appropriate data set for your experiment and draw graphs.

Head of the Department
Department of Computer Science
and Engineering
Ponnaiyah Ramajayam Institute of
Science & Technology (PRIST)
(Institution Deemed to be University
Uis 3 of the UGC Act 1956)
TIRUVANANTHAPURAM - 611 403, TAMIL NADU

DEAN
School of Engineering and Tech,
Ponnaiyah Ramajayam Institute of
Science and Technology (PRIST)
Deemed to be University
Vulliam, Thanjavur - 613 407



**PONNAIYAH RAMAJAYAM INSTITUTE OF
SCIENCE & TECHNOLOGY (PRIST)**

Declared as DEEMED TO BE UNIVERSITY
U/s 3 of UGC Act, 1956

SCHOOL OF ENGINEERING AND TECHNOLOGY

Department of Artificial Intelligence and Data Science

Academic year 2023-2024

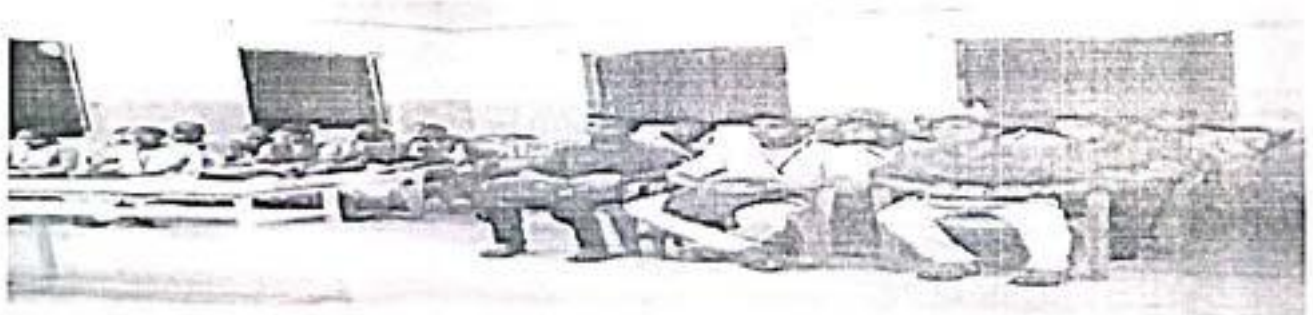

Head of the Department
Department of Computer Science
and Engineering
Ponnaiyah Ramajayam Institute of
Science & Technology (PRIST)
Deemed to be University
U/s 3 of the UGC Act, 1956
TIANJAVUR - 613 403, TAMIL NADU

DEAN
School of Engineering and Tech.
Ponnaiyah Ramajayam Institute of
Science and Technology (PRIST)
Deemed to be University
Vallam, Thanjavur - 613 403.



PONNAIYAH RAMAJAYAM INSTITUTE OF
SCIENCE & TECHNOLOGY (PRIST)

Declared as DEEMED TO BE UNIVERSITY
Dir 3 of UGC Act 1956

SCHOOL OF ENGINEERING AND TECHNOLOGY

DEPARTMENT OF ARTIFICIAL INTELLIGENCE AND DATA SCIENCE

PRIST/CSE/CIRCULAR/ADD ON 2

14.07.2023

CIRCULAR

SUB: ADD ON COURSE-Reg.,

It is informed that the department of AIDS is planning to organized a certified course on Mobile App Development using Android Studio on 18.07.2023 for the academic year 2023-2024.

Students from Artificial Intelligence and Data Science those who are interested can enroll their names and courses to the HOD on or before 17.07.23

Head of the Department
Department of Artificial Intelligence
and Data Science
Ponnaiyah Ramajayam Institute of
Science & Technology (PRIST)
(Deemed to be University)
Dir 3 of UGC Act 1956
THANJAVUR - 613 403, TAMIL NADU

DEAN
School of Engineering and Tect,
Ponnaiyah Ramajayam Institute of
Science and Technology (PRIST)
Deemed to be University
Vallam, Thanjavur-613 403.



From:

The HOD,
Department of AIDS,
Prist University,
Vallam, Thanjavur.

To:

The DEAN,
Prist University,
Vallam, Thanjavur.

Respected Sir,

Sub:- Requesting Permission for conducting Add on Course – Reg.

I wish to bring to your kind information that the department of AIDS has planned to conduct the following Add On course programme for the academic year 2023-24 odd semester.

As the department is equipped with relevant lab facilities and enterprise in the same field, we are requesting the permission for the conduct of the same.

Duration: 45 Hrs.

Thanking You.

Yours Truly,
HOD/AIDS

Head of the Department
Department of Curriculum, Science
& Engineering
Ponnaiyah Ramajayam Institute of
Science & Technology (PRIST)
Vallam, Thanjavur - 613 403
THANJAVUR - 613 403

DEAN
School of Engineering and Tech.
Ponnaiyah Ramajayam Institute of
Science and Technology (PRIST)
Deemed to be University
Vallam, Thanjavur - 613 403.

MOBILE APP DEVELOPMENT USING ANDROID STUDIO

UNIT - I

Introduction to Android: The Android Platform, Android SDK, Eclipse Installation, Android Installation, Building you First Android application, Understanding Anatomy of Android Application, Android Manifest file.

UNIT - II

Android Application Design Essentials: Anatomy of an Android applications, Android terminologies, Application Context, Activities, Services, Intents, Receiving and Broadcasting Intents, Android Manifest File and its common settings, Using Intent Filter, Permissions.

UNIT - III

Android User Interface Design Essentials: User Interface Screen elements, Designing User Interfaces with Layouts, Drawing and Working with Animation.

UNIT - IV

Testing Android applications, Publishing Android application, Using Android preferences, Managing Application resources in a hierarchy, working with different types of resources.

UNIT - V

Using Common Android APIs: Using Android Data and Storage APIs, Managing data using Sqlite, Sharing Data between Applications with Content Providers, Using Android Networking APIs, Using Android Web APIs, Using Android Telephony APIs, Deploying Android Application to the World.

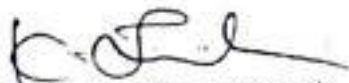

Head of the Department
Department of Computer Science
and Engineering
Ponnaiyah Ramajayam Institute of
Science & Technology (PRIST)
(Insulation Deemed to be University
's 3 of the UGC Act, 1956)
THANJAVUR - 613 403, TAMIL NADU



DEAN
School of Engineering and Tech.
Ponnaiyah Ramajayam Institute of
Science and Technology (PRIST)
Deemed to be University
Vailam, Thanjavur - 613 403.

Mobile app development using Android Studio involves a series of steps to design, build, and test Android applications. Android Studio is the official Integrated Development Environment (IDE) for Android development, providing a comprehensive set of tools for app development. Here's a guide to getting started with Android Studio for mobile app development:

1. Setting Up Android Studio

Download and Install:

- **Download:** Go to the [Android Studio website](#) and download the installer for your operating system (Windows, macOS, or Linux).
- **Install:** Follow the installation instructions. This process will include setting up the Android SDK, Android Profiler, and other necessary components.

Initial Configuration:

- **Open Android Studio:** Launch Android Studio and complete the setup wizard, which includes installing additional components and setting up the development environment.

2. Creating a New Project

Start a New Project:

- **File > New > New Project:** Choose a project template based on the type of app you want to build (e.g., Empty Activity, Basic Activity).
- **Configure Your Project:** Enter your application name, package name, save location, and minimum API level.

3. Exploring the Project Structure

Project Files and Directories:

- **app/src/main/java/:** Contains your Java/Kotlin source code files.
- **app/src/main/res/:** Contains resources like layouts, strings, and images.
- **app/src/main/AndroidManifest.xml:** Contains essential information about your app, such as permissions and activities.
- **build.gradle:** Contains build configuration and dependencies.

4. Designing the User Interface

XML Layout Files:

- **Open res/layout/activity_main.xml:** Use the Layout Editor to drag and drop UI components or write XML code to define the app's layout.
- **Design and Code Views:** Toggle between the Design and Code views to adjust your layout.

5. Writing the Code

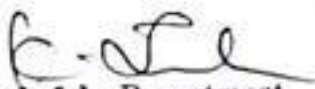

Head of the Department
Department of Computer Science
and Engineering
Ponnalyah Ramajayam Institute of
Science & Technology (PRIST)
(Insulation Deemed to be University
1/15 3 of the UGC Act, 1956)
THANJAVUR - 613 403, TAMIL NADU



DEAN
School of Engineering and Tech.
Ponnalyah Ramajayam Institute of
Science and Technology (PRIST)
Deemed to be University
Vaiiam, Thanjavur - 613 403

Activity Class:

- **Open MainActivity.java or MainActivity.kt:** This is where you write the code for your app's main activity.
- **Event Handling:** Write code to handle user interactions, such as button clicks and input validation.

Connecting UI to Code:

- **Find UI Elements:** Use `findViewById` (Java) or `findViewById` with Kotlin synthetic properties to get references to your UI elements.
- **Set Up Listeners:** Attach event listeners to respond to user actions.

6. Adding Functionality

Libraries: Use Android

- **Dependencies:** Add libraries to your `build.gradle` file to integrate functionalities like networking (Retrofit), image loading (Glide), or database management (Room).

Accessing Data:

- **Local Storage:** Use SQLite or Room for local databases, or SharedPreferences for simple key-value pairs.
- **Remote Data:** Use Retrofit or Volley for network operations to fetch data from web services.

7. Testing Your App

Run on Emulator or Device:

- **Android Emulator:** Configure and start an emulator through Android Studio to test your app on a virtual device.
- **Physical Device:** Connect a physical Android device via USB and enable Developer Options and USB Debugging.

Writing Tests:

- **Unit Tests:** Write unit tests to verify the functionality of individual components.
- **UI Tests:** Use Espresso or UI Automator to test user interactions and app behavior.

8. Debugging

Logcat:

- **View Logs:** Use Logcat to view logs and debug messages from your app.
- **Breakpoints:** Set breakpoints in your code and use the debugger to step through and inspect code execution.

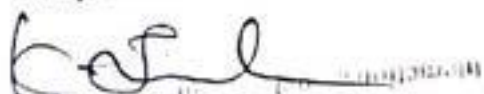

Head of the Department
Department of Computer Science
and Engineering
Ponnalyah Ramajayam Institute of
Science & Technology (PRIST)
(Institution Deemed to be University
under Section 3 of the UGC Act, 1956)
THANJAVUR - 613 403, TAMIL NADU



Head of the Department
School of Engineering and Tech.
Ponnalyah Ramajayam Institute of
Science and Technology (PRIST)
Deemed to be University
Vailam, Thanjavur - 613 403.

9. Building and Publishing

Build APKs

- **Build > Build Bundle(s) / APK(s) > Build APK(s):** Generate the APK file for distribution.
- **Sign Your APK: Generate Signed Bundle/APK:** Follow the wizard to sign your APK with a release key for distribution.

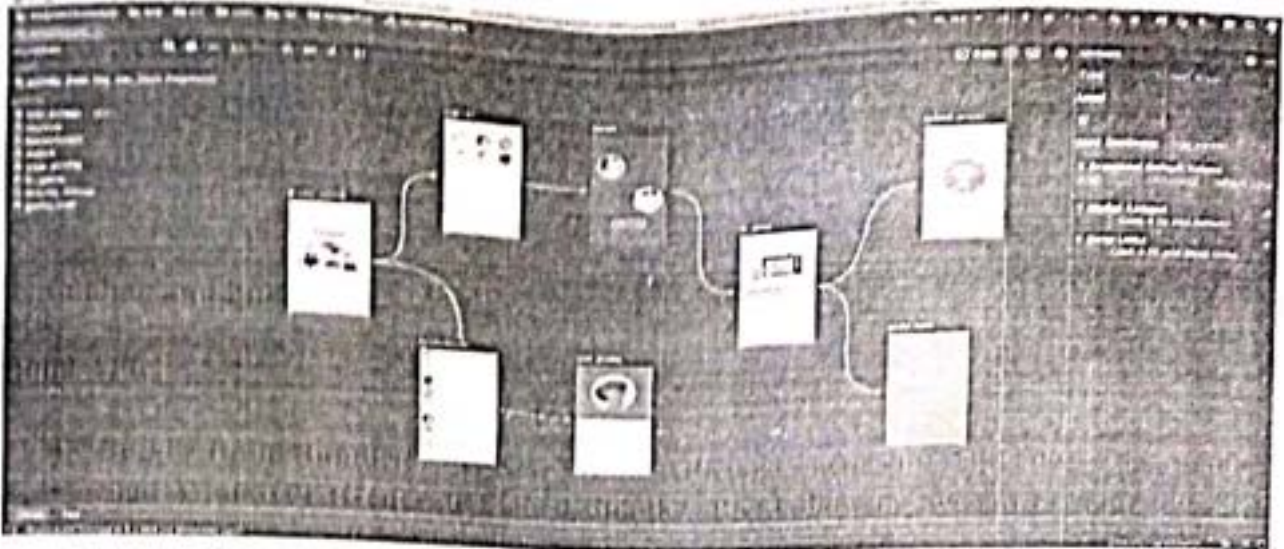

Publish to Google Play Store:

- **Create Developer Account:** Sign up for a Google Play Developer account.
- **Prepare Store Listing:** Provide app details, screenshots, and other information.
- **Upload APK:** Submit your APK for review and release.

10. Maintaining Your App

Updates:

- **Enhance Features:** Regularly update your app with new features and improvements.
- **Fix Bugs:** Address any issues reported by users or found during testing.

Analytics:

- **Integrate Analytics:** Use Google Analytics or Firebase Analytics to track user behavior and app performance.

Features and considerations in mobile app development:

1. User Interface (UI) Design

- **Responsive Design:** Adapts to various screen sizes and orientations.
- **Intuitive Navigation:** Easy-to-use navigation elements like menus, tabs, and buttons.

Head of the Department
Department of Computer Science
and Engineering
Ponnalyah Ramajayam Institute of
Science & Technology (P
(Institution Deemed to be Univ
11th 3 of the UGC Act
THANJAVUR - 613 403, TAMIL NADU

DEAN
School of Engineering and Tech.
Ponnalyah Ramajayam Institute of
Science and Technology (PRIST)
Deemed to be University
Vallam, Thanjavur - 613 403.

- **Interactive Elements:** Engaging components such as animations, transitions, and feedback (e.g., button presses).
- **Consistent Styling:** Use of consistent colors, fonts, and design patterns following platform guidelines (Material Design for Android, Human Interface Guidelines for iOS).

2. User Experience (UX)

- **Onboarding:** Introduction screens and tutorials to help users get started.
- **Accessibility:** Features like voice control, screen readers, and high-contrast modes to make the app usable for people with disabilities.
- **Performance Optimization:** Ensuring fast load times and smooth interactions.
- **Personalization:** Customizable settings and preferences to tailor the experience to individual users.

3. Functionality

- **Core Features:** Essential functionalities that the app is designed to deliver (e.g., messaging, navigation, social networking).
- **Push Notifications:** Alert users about important events or updates.
- **Offline Capability:** Allow users to access certain features or content without an active internet connection.
- **Multilingual Support:** Localization and internationalization to support multiple languages and regions.

4. Integration

- **API Integration:** Connect with third-party services and APIs (e.g., social media, payment gateways, cloud storage).
- **Social Media:** Integration with platforms like Facebook, Twitter, or Instagram for login, sharing, and engagement.
- **Maps and Geolocation:** Incorporate location-based services and map functionalities (e.g., Google Maps API, location tracking).

5. Data Management

- **Local Storage:** Use of databases (SQLite, Room) or file storage for offline data.
- **Cloud Storage:** Integration with cloud services for data synchronization and backup (e.g., Firebase, AWS).
- **Data Security:** Encryption and secure storage of sensitive information.

6. Security Features

- **Authentication:** Support for various authentication methods, including passwords, biometrics (fingerprint, facial recognition), and OAuth.
- **Authorization:** Ensuring that users have the appropriate permissions to access specific features or data.
- **Secure Communication:** Use of HTTPS and other security protocols to protect data in transit.



Head of the Department
Department of Computer Science
and Engineering
Ponnalyah Ramajayam Institute of
Science & Technology (PRIST)
(Institution Deemed to be University
As 3 of the UGC Act, 1956)
THANJAVUR - 613 403, TAMIL NADU



DEAN
School of Engineering and Tech.
Ponnalyah Ramajayam Institute of
Science and Technology (PRIST)
Deemed to be University
Vairam, Thanjavur - 613 403

7. Testing and Quality Assurance

- **Automated Testing:** Unit tests, UI tests, and integration tests to ensure app stability and performance.
- **Manual Testing:** Hands-on testing to identify usability issues and bugs.
- **Performance Testing:** Assess app performance under different conditions (e.g., load testing, stress testing).

8. Deployment and Distribution

- **App Store Submission:** Process for submitting apps to Google Play Store, Apple App Store, or other app marketplaces.
- **Version Control:** Manage different versions of the app and handle updates and patches.
- **Analytics and Monitoring:** Tools for tracking app usage, user behavior, and performance metrics (e.g., Google Analytics, Firebase Analytics).

9. Monetization

- **In-App Purchases:** Offer additional features or content for a fee within the app.
- **Subscription Models:** Recurring payments for premium features or content.
- **Advertisements:** Integrate ads to generate revenue (e.g., banner ads, interstitials, rewarded ads).

10. User Feedback and Support

- **Feedback Mechanisms:** Provide ways for users to give feedback, report issues, or suggest features.
- **Customer Support:** Integration of support channels like chat, email, or FAQs.

11. Scalability and Maintenance

- **Code Architecture:** Use of scalable code architectures (e.g., MVVM, MVP) to manage growing complexity.
- **Regular Updates:** Periodic updates to add new features, fix bugs, and ensure compatibility with new OS versions.
- **Monitoring:** Continuously monitor app performance and user feedback to address issues and improve the app.

12. Compliance and Legal Considerations

- **Privacy Policies:** Clearly defined privacy policies and terms of service to inform users about data collection and usage.
- **Regulatory Compliance:** Adherence to legal requirements and guidelines, such as GDPR or CCPA.

Head of the Department
Department of Computer Science
and Engineering
Ponnaiyah Ramajayam Institute of
Science & Technology (PRIST)
(Insulation Deemed to be University
11% 3 of the UGC Act. 1)
THANJAVUR - 613 403, TAMIL NADU

DEAN
School of Engineering and Tech.
Ponnaiyah Ramajayam Institute of
Science and Technology (PRIST)
Deemed to be University
Vallam, Thanjavur - 613 403.





DEPARTMENT OF ARTIFICIAL INTELLIGENCE AND DATA SCIENCE

ACADEMIC YEAR 2023-24
ADD ON COURSE ATTENDANCE
MOBILE APP DEVELOPMENT USING ANDROID STUDIO

SNO	REG NO	NAME LIST
1.	2201AD10101	T.PORTRAMARIYAN
2.	2201AD10102	A.FREDRICK B.V.AMINTO
3.	2201AD10103	S.R.ASHWIN BARATHI
4.	2201AD10104	AI.WISNIRMAL P
5.	2201AD10105	ARUL PRAKASHI MU
6.	2201AD10106	ARUNKUMAR V
7.	2201AD10107	CHANDIRAN M
8.	2201AD10108	DIHANASEKARAN R
9.	2201AD10109	DIVAKAR S
10.	2201AD10110	GOWTHAM D
11.	2201AD10111	GURUPRASATH S
12.	2201AD10112	JAGATHEESAN J
13.	2201AD10113	JAI BALAJI
14.	2201AD10114	JAISANGAR S
15.	2201AD10115	JAYAKUMAR N
16.	2201AD10116	JAYASEELAN J
17.	2201AD10117	KARTHIKEYAN T
18.	2201AD10118	MUKILAN M
19.	2201AD10119	PAGALAVAN M
20.	2201AD10120	PRAKASHI D
21.	2201AD10121	RAGUL R
22.	2201AD10122	RAJESH S
23.	2201AD10123	SANJAY KUMAR E

24.	2201AD13101	SIVAMANI P
25.	2201AD13104	SUBASUS
26.	2201AD13102	SUDHAKSAN M
27.	2201AD13103	SURYAMOORTHY S
28.	2201AD13105	THANGARASU P
29.	2201AD13106	VIGNESH M
30.	2201AD13107	ABILASHI M
31.	2201AD13108	AKALYA D
32.	2201AD13109	AUGUSTIN RAJ J
33.	2201AD13110	AIEX A
34.	2201AD13111	BHUVANESWARAN K J
35.	2201AD13112	DESIKAN R
36.	2201AD13113	DIHANUSHIVAN D
37.	2201AD13114	DIHARANIKANTH P
38.	2201AD13115	RAJA SA
39.	2201AD13116	GOWTHAM P
40.	2201AD13117	HARIBARAN M S
41.	2201AD13118	R.SANTHOSH
42.	2201AD13119	G.MERCY
43.	2201AD13120	V.RANJITH
44.	2201AD13121	JOSHIVA PHILIP RAJ T J
45.	2201AD13122	JOTHIKA S
46.	2201AD13123	KAMALAKANNAN R
47.	2201AD13124	KESAVAN K

Head of the Department
Department of Computer Science
and Engineering
Ponnaiyah Ramajayam Institute of
Science & Technology (PRIST)
(Insulation Deemed to be University
115 3 of the UGC Act, 1956)



DEAN
School of Engineering and Tech.
Ponnaiyah Ramajayam Institute of
Science and Technology (PRIST)
Deemed to be University
Valiam, Thanjavur - 613 013

48	2201AD13125	MANIKANDAN S
49	2201AD13126	MUHAMMAD RAHEEK S N
50	2201AD13127	NANDHAKUMAR S
51	2201AD13128	RANJITH M

52	2201AD13129	AUSTIN AMIRISIL
53	2201AD13130	CHRISTOPHER A ENIYAN CHEGUAWARA C S
54	2201AD13131	
55	2201AD13132	JAYASURYAR

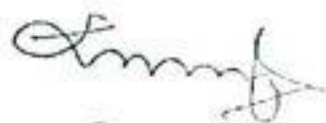

Head of the Department
 Department of Computer Science
 and Engineering
 Ponnalyah Ramajayam Institute of
 Science & Technology (PRIST)
 (Institution Deemed to be University
 U/s 3 of the UGC Act, 1956)
 THANJAVUR - 613 403, TAMIL NADU



DEAN
 School of Engineering and Tech.
 Ponnalyah Ramajayam Institute of
 Science and Technology (PRIST)
 Deemed to be University
 Vallam, Thanjavur - 613 403.



PONNAIYAH RAMAJAYAM INSTITUTE OF
SCIENCE & TECHNOLOGY (PRIST)

DECLARED AS DEEMED TO BE UNIVERSITY
UNDER SECTION 3 OF THE UGC ACT, 1956

DEPARTMENT OF ARTIFICIAL INTELLIGENCE AND DATA SCIENCE

ACADEMIC YEAR 2023-2024

TIME TABLE – MOBILE APP DEVELOPMENT USING ANDROID STUDIO

MONTH	DATE	HOURS
JULY	18.7.23	45HRS
	19.7.23	
	20.7.23	
	21.7.23	
	24.7.23	
	25.07.23	
	26.7.23	
	27.7.23	
	28.7.23	

Head of the Department
Department of Computer Science
and Engineering
Ponnaiyah Ramajayam Institute of
Science & Technology (PRIST)
(Institution Deemed to be University
under Section 3 of the UGC Act, 1956)
THANJAVUR - 613 403, TAMIL NADU

DEAN
School of Engineering and Tech.
Ponnaiyah Ramajayam Institute of
Science and Technology (PRIST)
Deemed to be University
Vallam, Thanjavur - 613 403.



**PONNAIYAH RAMAJAYAM INSTITUTE OF
SCIENCE & TECHNOLOGY (PRIST)**

Declared as DEEMED TO BE UNIVERSITY
Via 3 of UGC Act 1956

**SCHOOL OF ENGINEERING AND TECHNOLOGY
DEPARTMENT OF ARTIFICIAL INTELLIGENCE AND DATA SCIENCE**

PRIST/CSE/CIRCULAR/ADD ON 2

12.03.2024

CIRCULAR

SUB: ADD ON COURSE-Reg.,

It is informed that the department of AIDS is planning to organized a certified course on Developing apps with Google Cloud Platforms on 15.03.2024 for the academic year 2023-2024.

Students from Artificial Intelligence and Data Science those who are interested can enroll their names and courses to the HOD on or before 14.03.2024.

Head of the Department
Department of Computer Science
and Engineering
Ponnaiyah Ramajayam Institute of
Science & Technology (PRIST)
(Institution Deemed to be University
Via 3 of the UGC Act, 1956)
THANJAVUR - 613 403, TAMIL NADU

DEAN
School of Engineering and Tech.
Ponnaiyah Ramajayam Institute of
Science and Technology (PRIST)
Deemed to be University
Valiam, Thanjavur - 613 403.



PONNAIYAH RAMAJAYAM INSTITUTE OF
SCIENCE & TECHNOLOGY (PRIST)
DECLARED AS DEEMED TO BE UNIVERSITY
U/S 3 OF UGC ACT 1956

From:

The HOD,
Department of AIDS,
Prist University,
Vallam, Thanjavur.

To:

The DEAN,
Prist University,
Vallam, Thanjavur.

Respected Sir,

Sub:- Requesting Permission for conducting Add on Course – Reg.

I wish to bring to your kind information that the department of AIDS has planned to conduct the following Add On course programme for the academic year 2023-24 odd semester.

As the department is equipped with relevant lab facilities and enterprise in the same field, we are requesting the permission for the conduct of the same.

Duration: 45 Hrs.

Thanking You,

Yours Truly,
HOD / AIDS

Head of the Department
Department of Computer Science
and Engineering
Ponnaiyah Ramajayam Institute of
Science & Technology (PRIST)
(Institution Deemed to be University
U/S 3 of the UGC Act, 1956)
THANJAVUR - 613 403, TAMIL NADU

DEAN
School of Engineering and Tech.
Ponnaiyah Ramajayam Institute of
Science and Technology (PRIST)
Deemed to be University
Vallam, Thanjavur - 613 403.

DEVELOPING APPS WITH GOOGLE CLOUD PLATFORM

UNIT I: OVERVIEW CLOUD & GOOGLE CLOUD PLATFORM

Cloud Overview & Characteristics, Cloud Service Model (IaaS, PaaS, SaaS), Cloud Deployment Model (Public, Private, Hybrid), Google Cloud Platform (Gcp) Infrastructure Overview, Create Gcp Account & Console Overview, Organizations, Folders, Project

UNIT II- VIRTUAL MACHINES

Compute Engine (Vm): Types & Options, Vm Instance Lifecycle & Common Operations, Machine Types & Compute Options (Vcpu And Memory) In Compute Engine, Images & Snapshots, Disk Types: Local Ssd, Persistent & Balanced

UNIT III: VIRTUAL NETWORKS

Virtual Private Cloud (Vpc) & Types, Subnets, Ip Addresses (Public/Private), Nw, Routes & Route Table, Firewalls, Network Topology Options

UNIT IV: CLOUD IAM

Iam Basic: Authentication, Authorization & Mfa, Roles, Members, Service Account, Policy, Resource Hierarchy, Cloud Iam Best Practices

UNIT V: DATA STORAGE SERVICES

Google Cloud Storage Overview & Structure, Classes, Versioning & Lifecycle Policies, Cloud Sql For Database (Mysql, Postgresql And Sql Server), Cloud Spanner: Fully Managed Relational Db



Head of the Department
Department of Computer Science
and Engineering
Ponnaiyah Ramajayam Institute of
Science & Technology (P.R.I.T.)
(Insulation Deemed to be University
11/s 3 of the UGC Act, 1956)
THANJAVUR - 613 403, TAMIL NADU

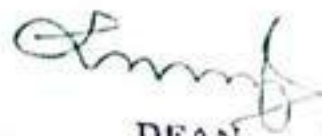

DEAN
School of Engineering and Tech,
Ponnaiyah Ramajayam Institute of
Science and Technology (P.R.I.T.)
Deemed to be University
Vullam, Thanjavur - 613 403.

Google Cloud Platform (GCP) is a suite of cloud computing services provided by Google. It is a public cloud computing platform consisting of a variety of services like compute, storage, networking, application development, Big Data, and more, which run on the same cloud infrastructure that Google uses internally for its end-user products, such as Google Search, Photos, Gmail and YouTube, etc.

The services of GCP can be accessed by software developers, cloud administrators and IT professionals over the Internet or through a dedicated network connection.

Google Cloud Platform

Google Cloud Platform is known as one of the leading cloud providers in the IT field. The services and features can be easily accessed and used by the software developers and users with little technical knowledge. Google has been on top amongst its competitors, offering the highly scalable and most reliable platform for building, testing and deploying the applications in the real-time environment.

Apart from this, GCP was announced as the leading cloud platform in the Gartner's IaaS Magic Quadrant in 2018. Gartner is one of the leading research and advisory company. Gartner organized a campaign where Google Cloud Platform was compared with other cloud providers, and GCP was selected as one of the top three providers in the market.

Benefits of Google Cloud Platform

Some of the main benefits of Google Cloud Platform are explained below:

Best Pricing: Google enables users to get Google Cloud hosting at the cheapest rates. The hosting plans are not only cheaper than other hosting platforms but also offer better features than others. GCP provides a pay-as-you-go option to the users where users can pay separately only for the services and resources they want to use.

Work from Anywhere: Once the account is configured on GCP, it can be accessed from anywhere. That means that the user can use GCP across different devices from different places. It is possible because Google provides web-based applications that allow users to have complete access to GCP.

Private Network: Google has its own network that enables users to have more control over GCP functions. Due to this, users achieve smooth performance and increased efficiency over the network.

Scalable: Users are getting a more scalable platform over the private network. Because Google uses fiber-optic cables to extend its network range, it is likely to have more scalability. Google is always working to scale its network because there can be any amount of traffic at any time.

- **On-demand services:** Automated environment with web-based tools. Therefore, no human intervention is required to access the resources.
- **Broad network access:** The resources and the information can be accessed from anywhere.
- **Resource pooling:** On-demand availability of a shared pool of computing resources to the users.

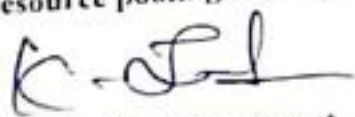

Head of the Department
Department of Computer Science
and Engineering
Ponnaiyah Ramajayam Institute of
Science & Technology (PRIST)
(Institution Deemed to be University
is a of the UGC Act 1956)



DEAN
School of Engineering and Tech,
Ponnaiyah Ramajayam Institute of
Science and Technology (PRIST)
Deemed to be University
Vairam, Thanjavur - 613 103.

- **Rapid elasticity:** The availability of more resources whenever required.
- **Measured service:** Easy-to-pay feature enables users to pay only for consumed services.



[Handwritten Signature]

Head of the Department
Department of Computer Science
and Engineering
Ponnalyah Ramajayam Institute of
Science & Technology (PRIST)
 (Institution Deemed to be University
 U-3 of the UGC Act, 1956)
THANJAVUR - 613 403, TAMIL NADU

[Handwritten Signature]

DEAN
School of Engineering and Tech.
Ponnalyah Ramajayam Institute of
Science and Technology (PRIST)
Deemed to be University
Vallam, Thanjavur - 613 403.



PONNAIYAH RAMAJAYAM INSTITUTE OF
SCIENCE & TECHNOLOGY (PRIST)

Declared as DEEMED TO BE UNIVERSITY
US 3 of UGC Act, 1956

DEPARTMENT OF ARTIFICIAL INTELLIGENCE AND DATA SCIENCE
ACADEMIC YEAR 2023-24
ADD ON COURSE NAME LIST
DEVELOPING APPS WITH GOOGLE CLOUD PLATFORMS

SNO	REG NO	NAME LIST	SNO	REG NO	NAME LIST
1.	2301AD10103	VASANTH S	23.	2301AD10213	NAVASRI S
2.	2301AD10104	HARIHARAN U	24.	2301AD10214	NISHANTHINI R
3.	2301AD10105	NITHISH KUMAR V	25.	2301AD10215	NITHYA KALYANI T
4.	2301AD10106	DAMYAN JOSHY A	26.	2301AD10216	NIVETHA R
5.	2301AD10107	PIRUTHIVIRAJ M	27.	2301AD10217	PARVATHI M
6.	2301AD10109	HARI RAGAVENDRAN, M	28.	2301AD10218	PRABA C
7.	2301AD10110	ENIYAVAN R	29.	2301AD10219	PRAGADEESHWARAN M
8.	2301AD10111	MOHAMED ARIF B	30.	2301AD10220	C.PRIYANKA
9.	2301AD10113	SANDHOSH P	31.	2301AD10221	PRIYA M
10.	2301AD10114	VEERASEKARAN R	32.	2301AD10222	PRIYADHARSHINI AR
11.	2301AD10115	DEEPAK T	33.	2301AD10223	PURUSOTHI N
12.	2301AD10116	SANTHOSH S	34.	2301AD10224	RAMAKRISHNAN M
13.	2301AD10117	SHEIK JAITH A	35.	2301AD10225	RAM KUMAR S
14.	2301AD10201	PRAGATHINI S	36.	2301AD10226	RUBY JERLINA K
15.	2301AD10202	AKSETHA B	37.	2301AD10227	SAKTHI S
16.	2301AD10203	LAKSHMI PRADHA G	38.	2301AD10228	SAKTHI KUMAR S
17.	2301AD10205	ABI A	39.	2301AD10229	SAKTHI NANDHINI V
18.	2301AD10207	SAHANAS BANU B	40.	2301AD10230	SANJAI P
19.	2301AD10208	JANNATHUL SHABANA S	41.	2301AD10231	SANJAIKUMAR P
20.	2301AD10210	DIVYADHARSHINI K	42.	2301AD10232	SARITHA C
21.	2301AD10211	GNANAMBIKAI M	43.	2301AD10233	SATHISH KUMAR S
22.	2301AD10212	SUGI S	44.	2301AD10234	SAVITHRI T
			45.	2301AD10235	SHYAM S

Head of the Department
Department of Computer Science
and Engineering

Ponnaiyah Ramajayam Institute of
Science & Technology (PRIST)
(Institution Deemed to be University
US 3 of the UGC Act, 1956)
THANJAVUR - 613 403, TAMIL NADU

DEAN

School of Engineering and Techn.
Ponnaiyah Ramajayam Institute of
Science and Technology (PRIST)
Deemed to be University
Vallam, Thanjavur - 613 403.

46.	2301AD10236	SIVARAMAN D
47.	2301AD10237	SOWMIYA B
48.	2301AD10238	SRILAKSHMI S
49.	2301AD10239	THAMARASELVI M
50.	2301AD10240	THEENAVANT
51.	2301AD10241	VARSHA R
52.	2301AD10242	VEERAMANI M

53.	2301AD10243	VIJAY SURIYA R
54.	2301AD10244	VISHVA DHARANI S
55.	2301AD10245	AKASHI RAJ T
56.	2301AD10246	PAUL JOSEPH U
57.	2301AD10247	SIAM SUNDAR S
58.	2301AD10248	SURIYA KUMAR B



Head of the Department
 Department of Computer Science
 and Engineering
 Ponnaiyah Ramajayam Institute of
 Science & Technology (PRIST)
 (Institution Deemed to be University
 U/s 3 of the UGC Act, 1956)
 THANJAVUR - 613 403, TAMIL NADU

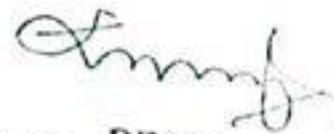

DEAN
 School of Engineering and Tech.
 Ponnaiyah Ramajayam Institute of
 Science and Technology (PRIST)
 Deemed to be University
 Vallam, Thanjavur - 613 403.



**PONNAIYAH RAMAJAYAM INSTITUTE OF
SCIENCE & TECHNOLOGY (PRIST)**

Declared as DEEMED TO BE UNIVERSITY
U/s 3 of UGC Act, 1956

DEPARTMENT OF ARTIFICIAL INTELLIGENCE AND DATA SCIENCE

ACADEMIC YEAR 2023-2024

TIME TABLE – DEVELOPING APPS WITH GOOGLE CLOUD PLATFORMS

MONTH	DATE	HOURS
MARCH	15.03.24	45HRS
	18.03.24	
	19.03.24	
	20.03.24	
	21.03.24	
	22.03.24	
	25.03.24	
	26.03.24	
	27.03.24	

Head of the Department
Department of Computer Science
and Engineering
Ponnaiyah Ramajayam Institute of
Science & Technology (PRIST)
(Institution Deemed to be University
U/s 3 of the UGC Act, 1956)
THANJAVUR - 613 403, TAMIL NADU

DEAN
School of Engineering and Tech.
Ponnaiyah Ramajayam Institute of
Science and Technology (PRIST)
Deemed to be University
Vailam, Thanjavur - 613 403.



DEPARTMENT OF ARTIFICIAL INTELLIGENCE AND DATA SCIENCE
ACADEMIC YEAR 2023-24
ADD ON COURSE ATTENDANCE
MOBILE APP DEVELOPMENT USING ANDROID STUDIO

S.NO	REG NO	NAME LIST	JULY								
			18.7.23	19.7.23	20.7.23	21.7.23	24.7.23	25.7.23	26.7.23	27.7.23	28.7.23
1.	2201ADI0101	T.PORTRAMARIYAN	/	/	/	/	/	/	/	/	/
2.	2201ADI0102	A.FREDRICK B.V.AMINTO	/	/	/	/	/	/	/	/	/
3.	2201ADI0103	S.R.ASHWIN BARATH	/	/	/	/	/	/	/	/	/
4.	2201ADI0104	ALWISNIRMAL P	/	/	/	/	/	/	/	/	/
5.	2201ADI0105	ARUL PRAKASH MU	/	/	/	/	/	/	/	a	/
6.	2201ADI0106	ARUNKUMAR V	/	/	/	/	/	/	/	/	/
7.	2201ADI0107	CHANDIRAN M	/	/	/	/	/	/	/	/	/
8.	2201ADI0108	DHANASEKARAN R	/	/	/	/	/	/	/	/	/
9.	2201ADI0109	DIVAKAR S	/	/	/	/	/	/	/	/	/
10.	2201ADI0110	GOWTHAM D	/	/	/	/	/	/	/	/	/
11.	2201ADI0111	GURUPRASATH S	/	/	/	/	/	a	/	/	/
12.	2201ADI0112	JAGATHEESAN J	/	/	/	/	/	/	/	/	/
13.	2201ADI0113	JAI BALAJI J	/	/	/	/	/	/	/	/	/
14.	2201ADI0114	JAISANGAR S	/	/	/	/	/	/	/	/	/
15.	2201ADI0115	JAYAKUMAR N	/	/	/	/	/	/	/	/	/
16.	2201ADI0116	JAYASEELAN J	/	/	/	/	/	/	/	/	/
17.	2201ADI0117	KARTHIKEYAN T	/	/	/	/	/	/	/	/	/



Head of the Department
Department of Computer Science
and Engineering
Ponnaiyah Ramajayam Institute of
Science & Technology
(Institution Deemed to be University
by 3 of the UGC Act, 1956)
THANJAVUR - 613 403, TAMIL NADU

DEAN
School of Engineering and Tech.
Ponnaiyah Ramajayam Institute of
Science and Technology (PRIST)
Deemed to be University
Veeram, Thanjavur - 613 403

18.	2201AD10118	MUKILAN M	/	/	/	/	/	/	/	/	/
19.	2201AD10119	PAGALAVAN M	/	/	/	/	/	/	/	/	/
20.	2201AD10120	PRAKASH D	/	/	/	/	/	/	/	/	/
21.	2201AD10121	RAGUL R	/	/	/	/	/	/	/	/	/
22.	2201AD10122	RAJESH S	/	/	/	/	/	/	/	/	/
23.	2201AD10123	SANJAY KUMAR E	/	/	/	/	/	/	/	/	/
24.	2201AD13101	SIVAMANI P	/	/	/	/	/	/	/	/	/
25.	2201AD13104	SUBASH S	/	/	/	/	/	/	/	/	/
26.	2201AD13102	SUDHARSAN M	/	/	/	/	/	/	/	/	/
27.	2201AD13103	SURYAMOORTHY S	/	/	/	/	/	/	/	/	/
28.	2201AD13105	THANGARASU P	/	/	/	/	/	/	/	/	/
29.	2201AD13106	VIGNESH M	/	/	/	/	/	/	a	/	/
30.	2201AD13107	ABILASH M	/	/	/	/	/	/	/	/	/
31.	2201AD13108	AKALYA D	/	/	/	/	/	/	/	/	/
32.	2201AD13109	AUGUSTIN RAJ J	/	/	/	/	/	/	/	/	/
33.	2201AD13110	AIEX A	/	/	/	/	/	/	/	/	/
34.	2201AD13111	BHUVANESWARAN K.J	/	/	/	/	/	/	/	/	/
35.	2201AD13112	DESIKAN R	/	/	/	/	/	/	/	/	/
36.	2201AD13113	DHANUSHYAN D	/	/	/	/	/	/	/	/	/
37.	2201AD13114	DHARANIKANTH P	/	/	/	/	/	/	/	/	/
38.	2201AD13115	RAJA SA	/	/	a	/	/	/	/	/	/
39.	2201AD13116	GOWTHAM P	/	/	/	/	/	/	/	/	/
40.	2201AD13117	HARIHARAN M S	/	/	/	/	/	/	/	/	/
41.	2201AD13118	R.SANTHOSH	/	/	/	/	/	/	/	/	/

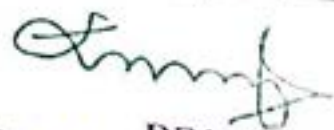

Head of the Department
 Department of Computer Science
 and Engineering
 Ponnalyah Ramajayam Institute of
 Science & Technology (PRIST)
 (Institution Deemed to be University
 by the UGC Act, 1956)
 THANJAVUR - 613 403, TAMIL NADU



DEAN
 School of Engineering and Tech.
 Ponnalyah Ramajayam Institute of
 Science and Technology (PRIST)
 Deemed to be University
 Thanjavur, Thanjavur - 613 403.

42.	2201AD13119	G.MERCY	/	/	/	/	/	/	/	/	/
43.	2201AD13120	V.RANJITH	/	/	/	/	/	/	/	/	/
44.	2201AD13121	JOSHVA PHILIP RAJ T J	/	/	/	/	/	/	/	/	/
45.	2201AD13122	JOTHIKA S	/	/	/	/	/	/	/	/	a
46.	2201AD13123	KAMALAKANNAN R	/	/	/	/	/	/	/	/	/
47.	2201AD13124	KESAVAN K	/	/	/	/	/	/	/	/	/
48.	2201AD13125	MANIKANDAN S	/	/	/	/	/	/	/	/	/
49.	2201AD13126	MOHAMED RABEEK S N	/	/	/	/	/	/	/	/	/
50.	2201AD13127	NANDHAKUMAR S	a	/	/	/	/	/	/	/	/
51.	2201AD13128	RANJITH M	/	/	/	/	/	/	/	/	/
52.	2201AD13129	AUSTIN AMBRISH L	/	/	/	/	/	/	/	/	/
53.	2201AD13130	CHRISTOPHER A	/	/	/	/	/	/	/	/	/
54.	2201AD13131	ENIYAN CHEGUAWARA C S	/	/	/	/	/	/	/	/	/
55.	2201AD13132	JAYASURYA R	/	/	/	/	/	/	/	/	/
Staff Signature											

Head of the Department
 Department of Computer Science
 and Engineering
 Ponnaiyah Ramajayam Institute of
 Science & Technology (PRIST)
 (Insulation Deemed to be University
 -/s 3 of the UGC Act, 1956)
 THANJAVUR - 613 403, TAMIL NADU

DEAN
 School of Engineering and Techn.
 Ponnaiyah Ramajayam Institute of
 Science and Technology (PRIST)
 Deemed to be University
 Vallam, Thanjavur-613 403.



PONNAIYAH RAMAJAYAM INSTITUTE OF
SCIENCE & TECHNOLOGY (PRIST)

Declared as DEEMED TO BE UNIVERSITY
On 3 of UGC Act 1956

DEPARTMENT OF ARTIFICIAL INTELLIGENCE AND DATA SCIENCE
ACADEMIC YEAR 2023-24

ADD ON COURSE ATTENDANCE
DEVELOPING APPS WITH GOOGLE CLOUD PLATFORMS

S.NO	REG NO	NAME LIST	MARCH								
			15.03.24	18.03.24	19.03.24	20.03.24	21.03.24	22.03.24	25.03.24	26.03.24	27.03.24
1.	2301AD10103	VASANTH S	/	/	/	/	/	/	/	/	/
2.	2301AD10104	HARIHARAN U	/	/	/	/	/	/	/	/	/
3.	2301AD10105	NITHISH KUMAR V	/	/	/	/	/	a	/	/	/
4.	2301AD10106	DAMYAN JOSHI V A	/	/	/	/	/	/	/	/	/
5.	2301AD10107	PIRUTHIVIRAJ M	/	/	/	/	/	/	/	/	/
6.	2301AD10109	HARI RAGAVENDRAN M	/	/	/	/	/	/	/	/	/
7.	2301AD10110	ENIYAVAN R	/	/	/	/	/	/	/	/	/
8.	2301AD10111	MOHAMED ARIF B	/	/	/	/	/	/	/	/	/
9.	2301AD10113	SANDHOSH P	/	/	/	/	/	/	/	/	/
10.	2301AD10114	VEERASEKARAN R	/	/	/	/	/	/	/	/	a
11.	2301AD10115	DEEPAK T	/	/	/	/	/	/	/	/	/
12.	2301AD10116	SANTHOSH S	/	/	/	/	/	/	/	/	/
13.	2301A010117	SHEIK JAITH A	/	/	/	/	/	/	/	/	/
14.	2301AD10201	PRAGATHINI S	/	/	a	/	/	/	/	/	/
15.	2301AD10202	AKSETHA B	/	/	/	/	/	/	/	/	/

Head of the Department
Department of Computer Science
and Engineering
Ponnaiyah Ramajayam Institute of
Science & Technology (PRIST)
(Insulation Deemed to be University
3 of the UGC Act 1956)

DEAN
School of Engineering and Tech.
Ponnaiyah Ramajayam Institute of
Science and Technology (PRIST)
Deemed to be University
Vullam, Thanjavur - 613 403

16.	2301AD10203	LAKSHMI PRADHA G	/	/	/	/	/	/	/	/	/
17.	2301AD10205	ABI A	/	/	/	/	/	/	/	/	/
18.	2301AD10207	SALIANAS BANU B	/	/	/	/	/	/	/	/	/
19.	2301AD10208	JANNATHUL SHABANA S	/	/	/	/	/	/	/	/	/
20.	2301AD10210	DIVYADHARSHINI K	/	/	/	/	/	/	/	/	a
21.	2301AD10211	GNANAMBIKAI M	/	/	/	/	/	/	/	/	/
22.	2301AD10212	SUGI S	/	/	/	/	/	/	/	/	/
23.	2301AD10213	NAVASRI S	/	/	/	/	/	/	/	/	/
24.	2301AD10214	NISHANTHINI R	/	/	/	/	/	/	/	/	/
25.	2301AD10215	NITHIYA KALYANIT	/	/	/	/	a	/	/	/	/
26.	2301AD10216	NIVETHA R	/	/	/	/	/	/	/	/	/
27.	2301AD10217	PARVATHI M	/	/	/	/	/	/	/	/	/
28.	2301AD10218	PRABA C	/	/	/	/	/	/	/	/	/
29.	2301AD10219	PRAGADEESHWARAN M	/	/	/	/	/	/	/	/	/
30.	2301AD10220	C.PRIYANKA	/	/	/	/	/	/	/	/	/
31.	2301AD10221	PRIYA M	/	/	a	/	/	/	/	/	/
32.	2301AD10222	PRIYADHARSHINI AR	/	/	/	/	/	/	/	/	/
33.	2301AD10223	PURUSOTHI N	/	/	/	/	/	/	/	/	/
34.	2301AD10224	RAMAKRISHNAN M	/	/	/	/	/	/	/	/	/
35.	2301AD10225	RAM KUMAR S	/	/	/	/	/	/	/	/	/
36.	2301AD10226	RUBY JERLINA K	/	/	/	/	/	/	/	/	/
37.	2301AD10227	SAKTHI S	/	/	/	/	/	/	/	/	/
38.	2301AD10228	SAKTHI KUMAR S	/	/	/	/	/	/	/	a	/
39.	2301AD10229	SAKTHI NANDHINI V	/	/	/	/	/	/	/	/	/

K. S. L.

Head of the Department
Department of Computer Science
and Engineering
Ponnaiyah Ramajayam Institute of
Science & Technology (PRIST)
(Institution Deemed to be University
Under Section 3 of the UGC Act, 1956)

[Signature]

DEAN
School of Engineering and Tech.
Ponnaiyah Ramajayam Institute of
Science and Technology (PRIST)
Deemed to be University
Vaitam, Thanjavur-613 402

40.	2301AD10230	SANJAI P	/	/	/	/	/	/	/	/	/
41.	2301AD10231	SANJAIKUMAR P	/	/	/	/	/	/	/	/	/
42.	2301AD10232	SARITHAC	/	/	/	/	/	/	/	/	a
43.	2301AD10233	SATHISH KUMAR S	/	/	/	/	/	/	/	/	/
44.	2301AD10234	SAVITHIRI T	a	/	/	/	/	/	/	/	/
45.	2301AD10235	SHIYAM S	/	/	/	/	/	/	/	/	/
46.	2301AD10236	SIVARAMAN D	/	/	/	/	/	/	/	/	/
47.	2301AD10237	SOWMIYA B	/	/	/	/	/	/	/	/	/
48.	2301AD10238	SRILAKSHMI S	/	/	/	/	/	/	/	/	/
49.	2301AD10239	THAMARAISELVI M	/	/	/	/	/	/	/	/	/
50.	2301AD10240	THEENAVAN T	/	/	/	/	/	/	/	/	/
51.	2301AD10241	VARSHA R	/	/	/	/	/	/	/	/	/
52.	2301AD10242	VEERAMANI M	/	/	/	/	/	/	/	/	/
53.	2301AD10243	VIJAY SURIYA R	/	/	/	/	/	/	a	/	/
54.	2301AD10244	VISHVA DHARANI S	/	/	/	/	/	/	/	/	/
55.	2301AD10245	AKASH RAJ T	/	/	/	/	/	/	/	/	/
56.	2301AD10246	PAUL JOSEPH U	/	/	/	/	/	/	/	/	/
57.	2301AD10247	SHAM SUNDAR S	/	a	/	/	/	/	/	/	/
58.	2301AD10248	SURIYA KUMAR B	/	/	/	/	/	/	/	/	/
Staff Signature											

 Head of the Department
 Department of Computer Science
 and Engineering
 Ponnaiyah Ramajayam Institute of
 Science & Technology (PRIST)
 (Insulation Deemed to be University
 U/s 3 of the UGC Act. 1956)
 THANJAVUR - 613 403, TAMIL NADU

 DEAN
 School of Engineering and Tech.
 Ponnaiyah Ramajayam Institute of
 Science and Technology (PRIST)
 Deemed to be University
 Vallam, Thanjavur - 613 403.

CERTIFICATE OF COMPLETION



**PRIST SCHOOL OF ENGINEERING &
TECHNOLOGY VALLAM, THANJAVUR-613 403**

DEPARTMENT OF COMPUTER SCIENCE AND ENGINEERING

This is to certify that Mr/Ms. T. POROTRAMARIYAN of

III - AI & DS has successfully completed the

Mobile App Development using Android Studio Add on Course from 18.7.23 to

28.7.23.

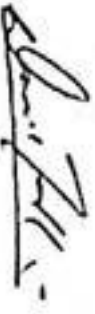
CO-ORDINATOR

HOD

DEAN

Head of the Department,
Department of Computer Science
and Engineering

Ponnaiyah Ramajayam Institute of
Science & Technology (PRIST)
(Insulation Deemed to be University,
Sec 3 of the UGC Act, 1956)
THANJAVUR - 613 403, TAMIL NADU

DEAN
School of Engineering and Tech.
Ponnaiyah Ramajayam Institute of
Science and Technology (PRIST)
Deemed to be University
Vallam, Thanjavur - 613 403

CERTIFICATE OF COMPLETION



**PRIST SCHOOL OF ENGINEERING &
TECHNOLOGY VALLAM, THANJAVUR-613 403**

DEPARTMENT OF COMPUTER SCIENCE AND ENGINEERING

This is to certify that Mr /Ms. GOWTHAM D of
III - AI&DS has successfully completed the
Mobile App Development using Android Studio on Course from 18.T.23 to
28.4.23.

CO-ORDINATOR

HOD

Head of the Department
Department of Computer Science and
Engineering
Ponnalyah Ramajayam Institute of
Science & Technology
(Deemed to be University)
Vallam, Thanjavur - 613 403, Tamil Nadu

DEAN
School of Engineering and Tech.
Ponnalyah Ramajayam Institute of
Science and Technology (PRIST)
(Deemed to be University)
Vallam, Thanjavur - 613 403.

CERTIFICATE OF COMPLETION



**PRIST SCHOOL OF ENGINEERING &
TECHNOLOGY VALLAM, THANJAVUR-613 403**

DEPARTMENT OF COMPUTER SCIENCE AND ENGINEERING

This is to certify that Mr /Ms. NIVETHA.R of

IT-AI&DS has successfully completed the

Developing Apps with Google Cloud Platforms Add on Course from 15.03.24 to

27.03.24.

CO-ORDINATOR

HOD

DEAN

Head of the Department
Department of Computer Science
and Engineering
Ponnalayah Ramajayam Institute of
Science & Technology (PRIST)
(Inspection Deemed to be University
Section 3 of the UGC Act, 1956)
THANJAVUR - 613 403, TAMIL NADU.

DEAN
School of Engineering and Tech.
Ponnalayah Ramajayam Institute of
Science and Technology (PRIST)
Deemed to be University
Vallam, Thanjavur - 613 403.

CERTIFICATE OF COMPLETION



**PRIST SCHOOL OF ENGINEERING &
TECHNOLOGY VALLAM, THANJAVUR-613 403**

DEPARTMENT OF COMPUTER SCIENCE AND ENGINEERING

This is to certify that Mr/Ms. MOHAMMED ARIE. B of II - AI&DS has successfully completed the

Developing Apps with Google Cloud Platform Add on Course from 15-03-20 to 27-03-20.

CO-ORDINATOR

HOD

DEAN

Head of the Department
Department of Computer Science
and Engineering

Ponnalyah Ramajayam Institute of
Science & Technology (PRIST)
(Insulation Deemed to be University
's 3 of the UGC Act. 1956)
THANJAVUR - 613 403, TAMIL NADU

DEAN

School of Engineering and Tech.
Ponnalyah Ramajayam Institute of
Science and Technology (PRIST)
Deemed to be University
Vallam, Thanjavur - 613 403